



BREMI

RADIATORS FOR ARCHITECTURE

PRICE LIST
N°25
MADE IN ITALY // ITALIAN LIFESTYLE

TECHNICAL CATALOGUE & PRICE LIST N° 25

VAT EXCLUDED

CATALOG PRICE INDEX N°25

<i>LAME COLLECTIONS</i>	page	9
LAME	page	10
LAME-UP	page	12
HERG	page	14
META	page	16
REGULAR	page	22
SBARRA SBARRA-UP	page	24
TORRI	page	26
GUEST	page	28
HERG-OT	page	30
HERG'S	page	32
HOOK	page	34
KUO	page	36
LAMATH	page	38
LAME SLIM	page	40
<i>CrossFRAME COLLECTIONS</i>	page	43
CROSS-Q	page	44
CROSS-G	page	46
CROSS-V	page	50
ALIS-ONE	page	52
ASYMM ASYMP	page	54
CROSS	page	56
CROSS-Q	page	60
CROSS GILDEN/SILVER LEAF	page	62
CROSS Bicolor Tricolor	page	62
CROSS-CROM	page	63
CROSS-R	page	66
CROSS-RV	page	68
ESSEN	page	70
FIT	page	72
FREE	page	74
KORE PLUS	page	76
PIT	page	78
QUAR	page	80
VISION	page	82
<i>PANELS COLLECTIONS</i>	page	85
CLAK	page	86
C-PROLUX®	page	90
EGON	page	94
LAMINA	page	98
OPEN	page	102
PHUL	page	106
SO-FLEX	page	108
S-PLATT	page	110
SUIT	page	114
CAMEO	page	120
CLARK	page	122
CUBICO	page	124
DUO	page	126
FLAG	page	128
GEOMETRICA-T GEO-O	page	130
GEOMETRICA-Q GEO-R	page	132
HOT	page	134
LOGGIA Design/Timeless	page	136
MANT	page	138
PLATT COLOR	page	140
PLATT INOX	page	142
PLATT Gilden/Silver leaf	page	143
UNI-PLATT	page	144
VELETTA	page	146
<i>TubesDESIGN COLLECTIONS</i>	page	149
CHEM	page	150
FORM	page	152
GRATA	page	156
RING	page	160
WIND	page	164
CANNUCCIA	page	168
CHEM-M	page	170
CHEM-S	page	172
FRAC	page	174
KUAD	page	176
MAHN	page	178
MAHN-AIR	page	180
PLANK	page	182
PLANK-AIR	page	184
PLUS 12	page	186
PLUS 18	page	188
PLUS-AIR	page	190
RAW vertical	page	192
RAW horizontal	page	194
SHAR	page	196
SHAR-AIR	page	198
START START CURVO	page	200
DIVIS dividers towel-trails	page	202
<i>ELECTRICAL COLLECTION</i>	page	205
<i>VALVES COLLECTION</i>	page	265
<i>ADVANCED wifi SYSTEM</i>	page	275
<i>BREM'ART COLLECTIONS after</i>	page	280
<i>CONDITIONS OF SALE</i>	page	308

ALPHABETICAL INDEX

ALIS-ONE	page	52	<i>ELECTRICAL COLLECTION</i>	page	205
ASYMM ASYMP	page	54	THERMOSTATS WiFi	page	208
C-PROLUX®	page	90	e.ALIS	page	210
CAMEO	page	120	e.ASYMM e.ASYMP	page	211
CANNUCCIA	page	168	e.CAMEO	page	212
CHEM	page	150	e.CANNUCCIA STRAW	page	213
CHEM-M	page	170	e.CHEM e.CHEM-M	page	214
CHEM-S	page	172	e.CHEM-S	page	215
CLAK	page	86	e.CLAK	page	216
CLARK	page	122	e.CLARK	page	217
CROSS	page	56	e.CROSS	page	218
CROSS Bicolor Tricolor	page	62	e.CROSS-Crom.-Gilden/Silver leaf	page	219
CROSS-CROM	page	63	e.CROSS-G	page	220
CROSS GILDEN/SILVER LEAF	page	62	e.CROSS-Q	page	221
CROSS-G	page	46	e.CROSS-R	page	222
CROSS-Q radiator	page	44	e.CROSS-V	page	220
CROSS-Q towel-trails	page	60	e.CUBICO	page	223
CROSS-R	page	66	e.DUO	page	224
CROSS-RV	page	68	e.ESSEN	page	225
CROSS-V	page	50	e.FIT	page	226
CUBICO	page	124	e.FLAG	page	227
DIVIS dividers towel-trails	page	202	e.FRAC	page	228
DUO	page	126	e.FREE	page	229
EGON	page	94	e.GEOMETRICA-T ..-O	page	230
ESSEN	page	70	e.GEOMETRICA-Q ..-R	page	231
FIT	page	72	e.GUEST	page	232
FLAG	page	128	e.HAND	page	233
FORM	page	152	e.HERG-OT	page	234
FRAC	page	174	e.HERG'S e.HERG	page	235
FREE	page	74	e.HOOK	page	236
GEOMETRICA-T GEO-O	page	130	e.KORE PLUS	page	237
GEOMETRICA-Q GEO-R	page	132	e.KUAD	page	238
GRATA	page	156	e.KUO	page	239
GUEST	page	28	e.LAMATH	page	240
HERG	page	14	e.LAME	page	241
HERG-OT	page	30	e.LAME SLIM	page	242
HERG'S	page	32	e.LAME-UP	page	243
HOOK	page	34	e.MAHN	page	244
HOT	page	134	e.MAHN-AIR	page	245
KORE PLUS	page	76	e.MANT	page	246
KUAD	page	176	e.PHUL	page	247
KUO	page	36	e.PIT	page	248
LAMATH	page	38	e.PLANK e.PLANK-AIR	page	249
LAME	page	10	e.PLATT	page	250
LAME SLIM	page	40	e.PLUS 12	page	251
LAME-UP	page	12	e.PLUS 18 e.PLUS-AIR	page	252
LAMINA	page	98	e.QUAR	page	253
LOGGIA Design/Timeless	page	136	e.RAW	page	254
MAHN	page	78	e.REGULAR	page	255
MAHN-AIR	page	180	e.SBARRA e.SBARRA-UP	page	256
MANT	page	138	e.SHAR	page	257
META	page	16	e.SHAR-AIR	page	258
OPEN	page	102	e.START e.START CURVO	page	259
PHUL	page	106	e.UniPLATT	page	260
PIT	page	78	e.VELETTA	page	261
PLANK	page	182	e.VISION	page	262
PLANK-AIR	page	84	e.ZOOM	page	263
PLATT COLOR	page	140			
PLATT F. ORO/FA	page	143	<i>BREM'ART COLLECTIONS after</i>	page	280
PLATT INOX	page	142	BACCU MANDARA	page	V
PLUS 12	page	186	CAPITONNÉ	page	VI
PLUS 18	page	188	CIRCO D'IDEE	page	XI
PLUS-AIR	page	190	CONTINUUM TRE SIPAR W	page	VIII
QUAR	page	80	EAGLE	page	XVI
RAW vertical	page	192	ERUZIONE	page	IX
RAW horizontal	page	194	FILU&FERRU	page	IV
REGULAR	page	22	FIRE	page	XIV
RING	page	160	GRAFFI	page	XX
S-PLATT	page	110	GRAFFI DI LUNA	page	XXI
SBARRA SBARRA-UP	page	24	GRID	page	XVII
SHAR	page	196	MUN	page	VII
SHAR-AIR	page	198	NOSTOS	page	XIII
SO-FLEX	page	108	PIET	page	XXII
START START CURVO	page	200	PINAK HOT	page	XV
SUIT	page	14	SCUDO DI ERACLE	page	XII
TORRI	page	26	SHANG	page	XVIII
UNI-PLATT	page	44	SPAZIO CHIUSO	page	III
VELETTA	page	146	STROP'	page	X
VISION	page	82	TERRA LUNARE TERRA	page	XIX
WIND	page	164	VIRGO	page	XXIII
ZOOM	page	263			

THE COLLECTIONS

page

LAME
RADIATORS WITH ELEMENTS



9

CrossFRAME
RADIATORS WITH FRAMES

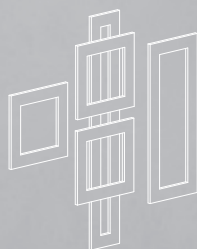

43

PANELS
RADIATORS WITH FLAT TUBES



85

TubesDESIGN
RADIATORS WITH TUBES

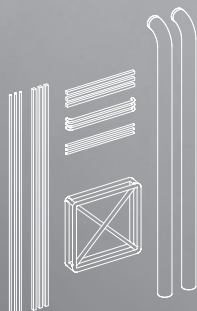

149

ELECTRIC MODELS RADIATORS & TOWEL HEATER

205

Valves&Accessories

265

BREM'ART
ARTIST'S RADIATORS



I-XXIV after 280

BREM. INNOVATION AND TRADITION

HEATING ELEMENTS THROUGH RESEARCH, EXPERIMENTATION AND INNOVATIVE DESIGN WITH RESPECT FOR TRADITION

BREM IS THE PRODUCT OF MEN AND WOMEN,
NOT ONLY TECHNOLOGY AND MACHINES,
SKILLED PEOPLE WHO CAN COMPLETE EVEN THE
MOST DEMANDING PROJECTS ON TIME AND
TRAINED IN THE TRANSFORMATION OF STEEL
INTO PRODUCTS OF THE HIGHEST QUALITY
AND WITH A HIGH AESTHETIC VALUE.

BREM: THE COLLECTION 2024

- 24 RADIATOR MODELS
- 55 HEATED TOWEL RAIL MODELS
- 3 CHROME-PLATED HEATED TOWEL RAILS
- 100.000 STANDARD SERIES DIMENSIONS
- 60 ELECTRIC TOWEL-RAILS and Radiators
- BREM'ART: RADIATOR ART
- VALVES, ACCESSORIES AND SUPPORTS

STRENGTHS

Specialized in the design and production of radiators and heated towel rails using steel tubes, BREM operates at the top end of the market thanks to the superior quality, original aesthetics, and many other distinctive features of its products.

QUALITY OF MATERIALS

High-quality steel produced to strict international standards; impeccable, high-precision working; secure, invisible welding; high gloss, bright and even paint treatment.

DESIGN

Manifolds with particular shapes; slender, flattened columns; tubes with exclusive shapes; adjustable brackets integrated into the radiator.

FUNCTIONALITY

The countless standard series versions possible (high, slender, long, wide, flat, etc.), permit the optimum insertion of the heating element in any space at all.

RANGE

A complete collection composed of 24 radiator models and 55 heated towel rail models ensures the most appropriate aesthetic solution for every interior.

MADE-TO-MEASURE VERSIONS

The elevated productive flexibility and constructive process of the radiators guarantee response to even the most unusual requests with a virtually unlimited number of applications.

CHARACTERISTICS

In the context of elevated aesthetic content, all BREM products meet the needs of living comfort, economical use, practical management, and easy installation.

REDUCED WEIGHT

Weight up to 1/3 lower than traditional tube heating elements and up to 1/8 lower than cast-iron radiators thanks to the use of slender tubes that also facilitate shipping and installation.

LOW WATER CONTENT

Reduction of up to 1/3 of the quantity of water required by traditional radiators.

INSTANT HEATING

The programmed temperature is reached rapidly thanks to the quality of steel used and the quick circulation of the small quantity of water contained.

COMFORTABLE ENVIRONMENT

Immediate stopping of heat emission by thermostat for greater comfort at constant temperature.

ENERGY SAVINGS

Lower energy consumption (thanks to lower volume of water to be heated) required for optimum heat emission.

COMFORTABLE WARMTH

Heating takes place by irradiation and convection. The sensation of wellbeing is guaranteed by the high percentage of heat irradiated.

ADVANTAGES

Depending on the model, BREM radiators permit:

- more rational installation without limits of any kind for more uniform heat distribution;
 - larger radiating surfaces that increase the quantity of heat transmitted through irradiation for greater comfort;
 - higher protection against cold walls and better ascending convection movement thanks to the larger surface area on the back;
 - original solutions. Thanks to their design, radiators can be installed in any setting;
 - to fit radiators into any available space from floor-to-ceiling, next to windows restricting the heat loss;
 - optimum use of space under the regular or large windows.
- Using different types of feet and support, BREM frees radiators from their traditional position on the wall to let them live in greater freedom through creative positioning elsewhere in the room, such as:
- partition walls or screens in the center of the room
 - railings for stairways or balconies
 - in corners with two or more radiators
 - as a vertical arch on the wall
 - curved or in all the creative shapes technically possible.

TECHNICAL DATA

TECHNICAL DATA

Symbols

H	height
L	length /width
p	depth
▲▽	tapping centres (t.c.)
PE	element step
A	surface
V	volume
M	weight empty
Q _n	nominal calorific power
Q	heat output
S	surface of heat output
n	exponent
ck	correction factor for Q _n
m	flow rate
EHE	Electric Heating Element

Unit	
cm	
cm	
mm	
mm	
mm	
m ²	
dm ³	
kg	
W	
W	
S	
-	
-	
kg/s	
W	

COEFFICIENT OF TRANSFORMATION

1 W = 0,86 kcal / h
1 kcal / h = 1,16 W

NOMINAL QN INDEX

Nominal heat output index in Watts $\Delta t^n = 50K$
According to the EN 442 regulations, the heat output of a radiator is calculated according to the following conditions:

t ₁	inlet temperature	75°C
t ₂	outlet temperature	65°C
t _w	average water temperature	70°C
t _r	reference air temperature	20°C
K	water temperature	10 K
Δt	air-water temperature difference	50 K
Δt	different from 50 K	$Q = Q_n (\Delta t / 50)^n$

CORRECTION FACTORS (Δt different from 50K)

Δt^n	1,20	1,22	1,24	1,26	1,28	1,30
30k	0,542	0,536	0,530	0,526	0,520	0,514
40k	0,766	0,762	0,759	0,755	0,751	0,748
50k	1	1	1	1	1	1
60k	1,245	1,248	1,253	1,258	1,263	1,267
70k	1,498	1,507	1,518	1,527	1,538	1,549

AMBIENT TEMPERATURE different from 20°

To increase or to decrease the temperature of a room, apply the index defined in the catalogue to the following theoretical coefficients:

temperatures	24°C	22°C	20°C	18°C	15°C	12°C
multiplier	0,81	0,90	1,00	1,04	1,10	1,17

To make the connections without the radiator, use a template with the distance

between the tapping centres marked on it.

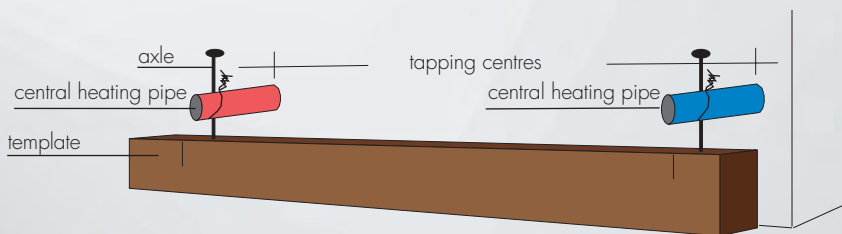

When replacing old radiators, make sure that there are no "siphons" created when installing the new fittings.

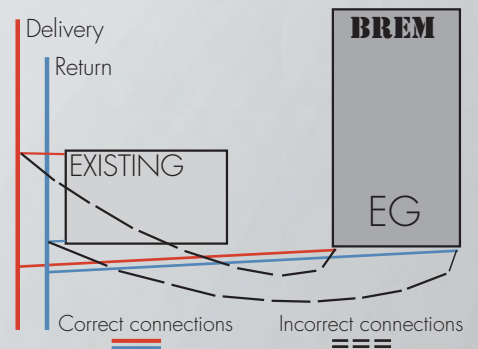

CONNECTING THE RADIATOR

As standard, Brem radiators are supplied with $\varnothing 3/8"$ - $\varnothing 1/2"$ attachment points.

In the instructions for each model a formula is shown to define the distance between centres of the connections.
(eg. model FH: tapp. centres = width - 40 mm)

RECOMMENDED INSTALLATION HEIGHTS

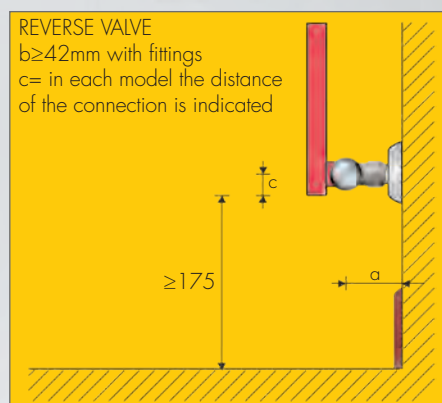
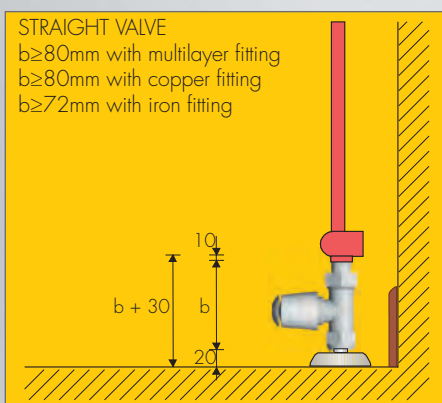
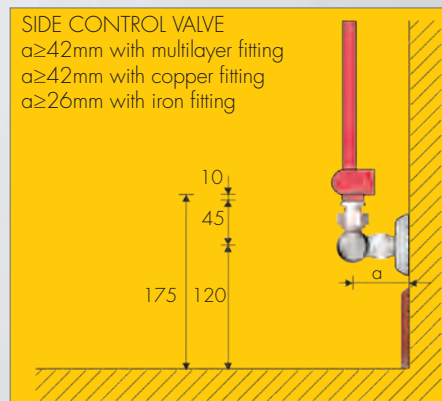
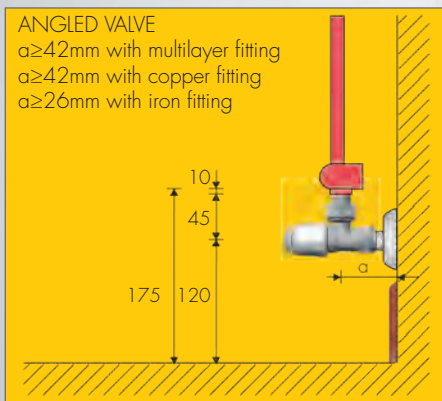

INSTALLATION AND EFFICIENCY

Always respect the position of the delivery and return fittings when connecting BREM radiators.

If EG fittings, the delivery must be at the bottom, on the left; if the position of the delivery is inverted ("G"), the radiator will not heat up completely.

A central heating plant providing pressure of 1.5/1.8 bar ensures that the radiators work evenly and efficiently.

If there is not enough pressure, hot water will not reach all points and the radiators will not warm up completely.

Check the pressure in column radiator systems, especially in residential blocks.

Make sure that there are no throttled pipes in the plant.

Bleed the air completely from the radiator.

Balance the plant by partially closing the water outlet valve.

INDEX: RADIATORS

LAME collection

LAME p.10
e.LAME p.241

LAME-UP p.12
e.LAME-UP p.243

HERG p.14
e.HERG p.235

META p.16

REGULAR p.22
e.REGULAR p.255

SBARRA p.24
SBARRA-UP p.24
e. SBARRA p.256

TORRI p.26

CrossFRAME collection

CROSS-Q p.44
e.CROSS-Q p.221

CROSS-G p.46
e. CROSS-G p.220

CROSS-V p.50
e.CROSS-V p.220

ALIS-ONE p.52
e.ALIS-ONE p.210

CROSS p.56
e.CROSS p.218

CROSS-Q p.60
e.CROSS-Q p.221

ASYM p.54
e.ASYM p.211

ASYMP p.54
e.ASYMP p.211

CROSS-R p.66
e.CROSS-R p.222

PANELS collection

CLAK p.86
e.CLAK p.216

EGON p.94

OPEN p.102

SO-FLEX p.108

C-Prolux® p.90

LAMINA p.98

PHUL p.106
e.PHUL p.247

S-PLATT p.110

SUIT p.114

CAMEO p.120
e.CAMEO p.212

CUBICO p.124
e.CUBICO p.223

CLARK p.122
e.CLARK p.217

DUO p.126
e.DUO p.224

TubesDESIGN collection

CHEM p.150
e.CHEM p.214

GRATA p.156

WIND p.164

FORM p.152

RING p.160

CANNUCCIA p.168
e.CANNUCCIA p.213

CHEM-M p.170
e.CHEM-M p.214

FRAC p.174
e.FRAC p.228

CHEM-S p.172
e.CHEM-S p.215

KUAD p.176
e.KUAD p.238



ELECTRIC Radiators

page 205-263



BREM'ART

pages I-XXIV, after page 264

VALVES

VALVES
page 265



ACCESSORIES
page 276

RAM p.277



TOWEL HEATERS



GUEST p.28
e.GUEST p.232

Herg-ÖT p.30
e.Herg-ÖT p.234

Herg'S p.32
e.Herg'S p.235

HOOK p.34
e.HOOK p.236

KUO p.36
e.KUO p.239

LAMATH p.38
e.LAMATH p.240

Lame SLIM p.40
e.Lame SLIM p.242

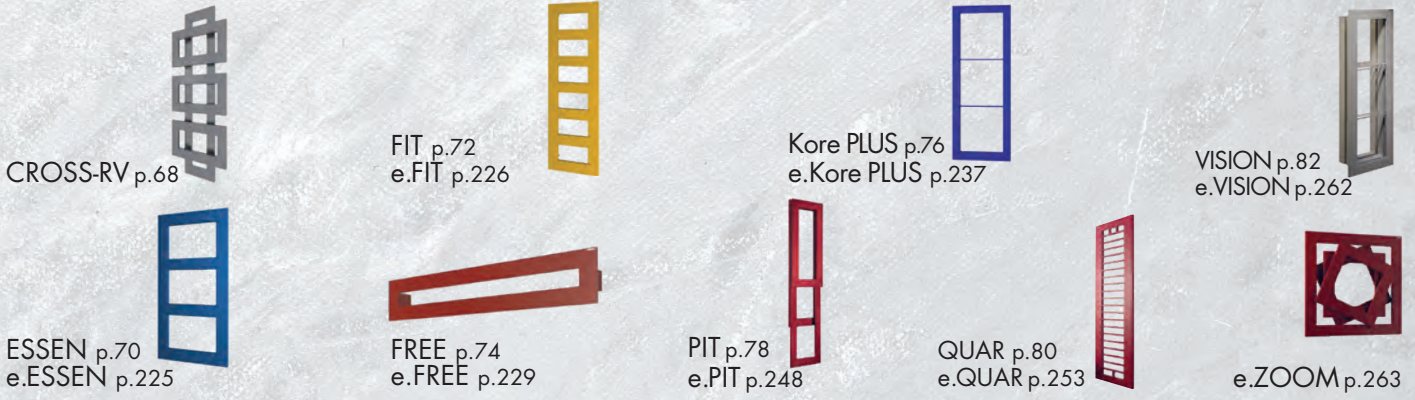

CROSS-RV p.68

FIT p.72
e.FIT p.226

Kore PLUS p.76
e.Kore PLUS p.237

VISION p.82
e.VISION p.262

ESSEN p.70
e.ESSEN p.225

FREE p.74
e.FREE p.229

PIT p.78
e.PIT p.248

QUAR p.80
e.QUAR p.253

e.ZOOM p.263

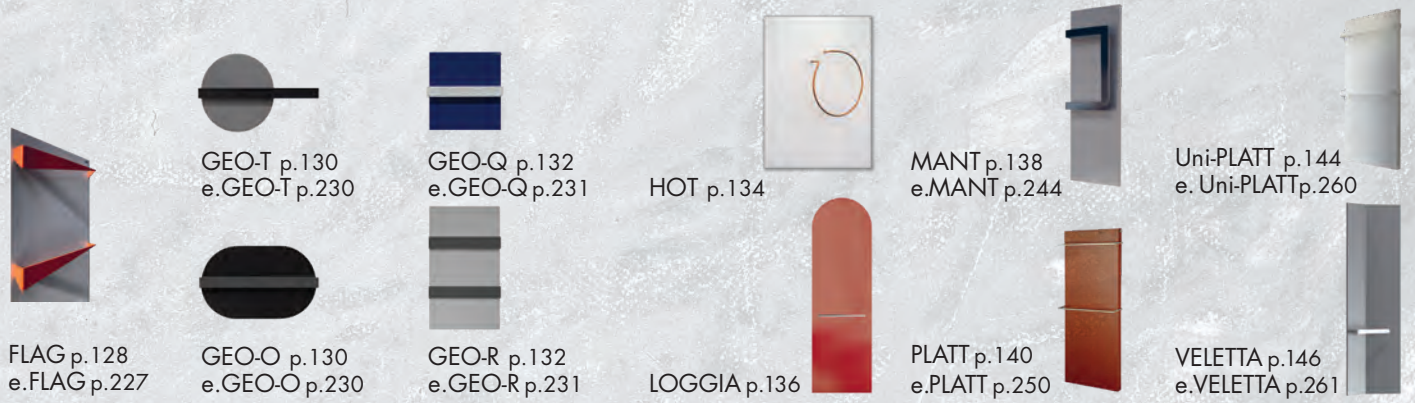

FLAG p.128
e.FLAG p.227

GEO-T p.130
e.GEO-T p.230

GEO-Q p.132
e.GEO-Q p.231

HOT p.134

MANT p.138
e.MANT p.244

Uni-PLATT p.144
e. Uni-PLATT p.260

GEO-O p.130
e.GEO-O p.230

GEO-R p.132
e.GEO-R p.231

LOGGIA p.136

PLATT p.140
e.PLATT p.250

VELETTA p.146
e.VELETTA p.261

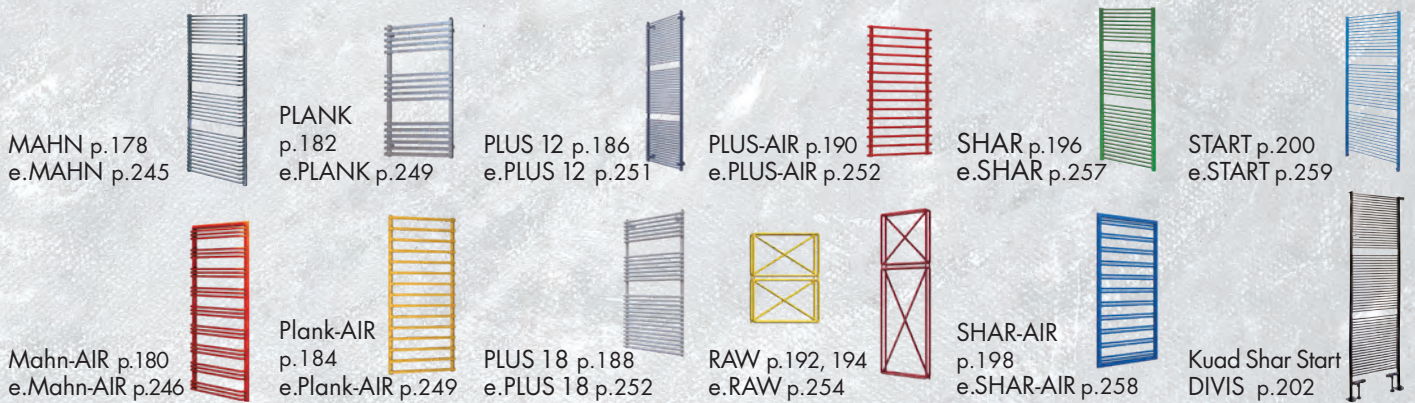

MAHN p.178
e.MAHN p.245

PLANK p.182
e.PLANK p.249

PLUS 12 p.186
e.PLUS 12 p.251

PLUS-AIR p.190
e.PLUS-AIR p.252

SHAR p.196
e.SHAR p.257

START p.200
e.START p.259

Mahn-AIR p.180
e.Mahn-AIR p.246

Plank-AIR p.184
e.Plank-AIR p.249

PLUS 18 p.188
e.PLUS 18 p.252

RAW p.192, 194
e.RAW p.254

SHAR-AIR p.198
e.SHAR-AIR p.258

Kuad Shar Start
DIVIS p.202

HAND p.233



ELECTRIC Towel heaters page 205-263

MAGNET p.277

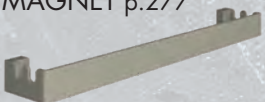

KNOBS
page 277



SPECIAL VERSIONS
page 276

TEMPERATURE CONTROL
Wi-Fi page 275

FITTINGS
page 278-279

BREM'ART

pages I - XXIV after page 264

THE COLLECTIONS

page

LAME
RADIATORS WITH ELEMENTS



9

CrossFRAME
RADIATORS WITH FRAMES

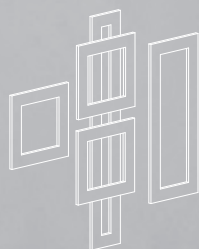

43

PANELS
RADIATORS WITH FLAT TUBES



85

TubesDESIGN
RADIATORS WITH TUBES



149

ELECTRIC MODELS RADIATORS & TOWEL HEATER

205

Valves & Accessories

265

BREM'ART
ARTIST'S RADIATORS



I-XXIV after 264

INDEX LAME

RADIATORS WITH ELEMENTS

RADIATORS COLLECTION

	page
LAME	10
LAME-UP	12
HERG	14
META	16
REGULAR	22
SBARRA ..	24
TORRI	26

TOWEL HEATER COLLECTION

	page
GUEST	28
HERG-OT	30
HERG'S	32
HOOK	34
KUO	36
LAMATH	38
LAME SLIM	40



LAME

design Davide Brembilla

LAME is composed of rectangular tubes connected by round bars. The heating

elements cut the air like knives and stand alongside one another in light to create

a new heating shape like no other and enliven modern sculpture for interior décor.

DIMENSIONS

Heights: 190 / 210 / 230 cm

Widths: 11 / 17 / 23 / 29 / 35 / 41 / 47 cm

Depth: 8 cm

Depth from wall: 9,5 cm

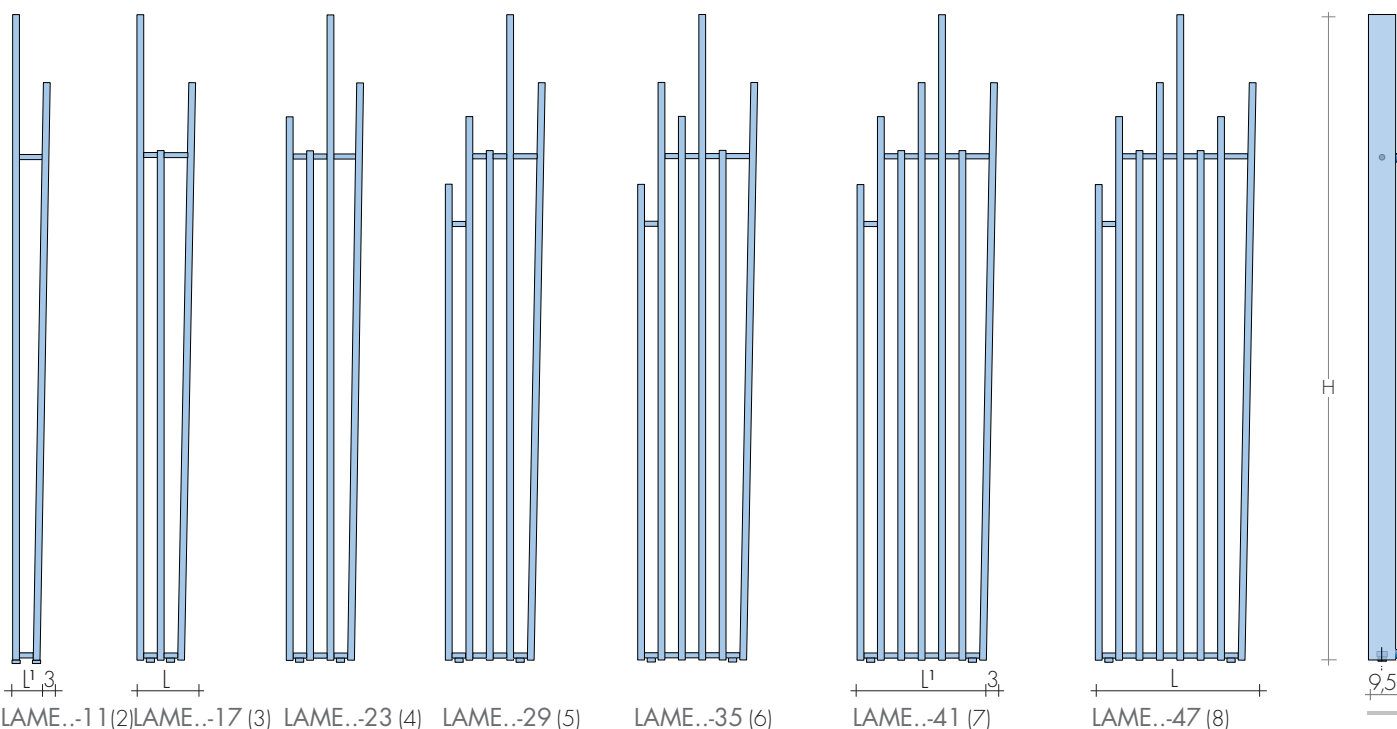

MODEL	H cm	L cm (n°el.)	EN 442 Watt Δt 50K (Δt 40K = $W \times 0,755$) (Δt 30K = $W \times 0,526$)						DUAL FUEL VERSION			
			11 (2)	17 (3)	23 (4)	29 (5)	35 (6)	41 (7)	47 (8)	Model	Watt	€
LAME 190	190	L1 cm	8	14	20	26	32	38	44	with E.H.E. and sleeve		
		▲▼ cm	6	6	12	18	24	30	36	LAME 190-11	400	127,40
LAME 210	210	€	625,00	768,40	911,80	1055,30	1198,50	1341,90	1485,10	LAME 190-17	500	129,60
			350w	496w	652w	788w	953w	1109w	1255w	LAME 190-23	650	131,80
LAME 230	230	€	661,90	824,10	986,20	1148,60	1310,60	1472,60	1634,80	LAME 190-29	800	136,60
			389w	554w	730w	885w	1070w	1245w	1411w	LAME 190-35	900	140,20
LAME 230	230	€	697,10	876,50	1055,60	1234,60	1415,20	1592,80	1770,20	LAME 210-41	1200	148,50
			428w	613w	807w	982w	1187w	1381w	1566w	LAME 210-47	1500	159,40

Available in Stock

Other models on request

Thermostats p.208-209

E.g.: LAME 210-35, EG \varnothing 1/2", SB3061

STANDARD PRODUCTION

White sablé SB9016 paintwork - Brackets B15
Tolerance \pm 3mm - Air vent \varnothing 1/8"

MAXIMUM OPERATING PRESSURE 4 BAR

PRODUCTION ON REQUEST

Paintwork to Brem color list (colored B15
brackets)

Electric version eLame,

STANDARD FITTING

EG \varnothing 1/2"

On request fitting \varnothing 3/8"

Special fittings, page 278



TAPPING CENTRES

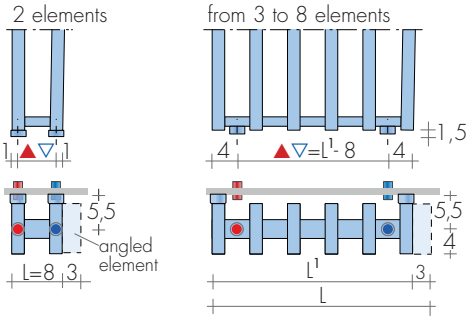

MIXED VERSIONS

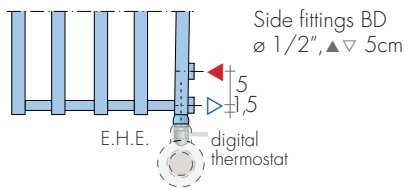

FIXINGS

B15 brackets included, B27 with remote fittings and B35 Lame ...-11

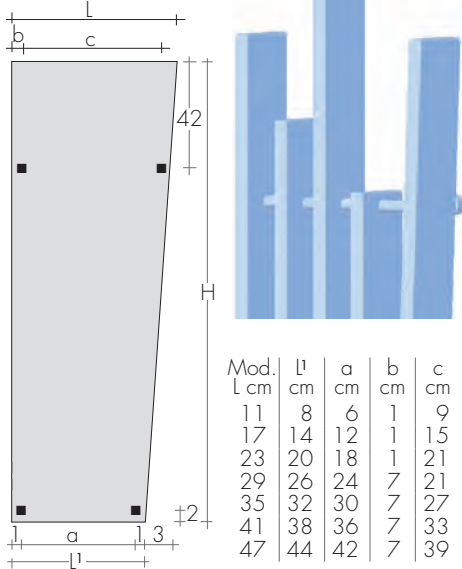

RECOMMENDED VALVES

CHROME VALVES KIT with:

- n°2 Valves with tailpieces
- n°2 Fittings (multilayer ø16, copper ø12, 14)
- n°2 Chrome wall plates ø 48, hole ø16

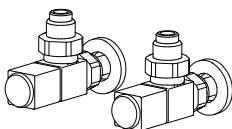

ANGLED QUADRA VALVES KIT
page 271 Art. KQS 180,10€
Extra for BREM color list 53,40€

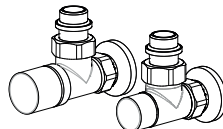

ANGLED CYL VALVES KIT with THERMOSTATIC
option, page 273 Art. KCS 149,90€
Extra for BREM color list 53,40€

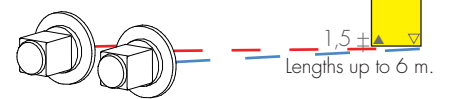

SPECIAL FINISHES page 267
Finishes Gold, Bronze, Brushed Nickel for 2 valves
Brushed Nickel FITTING KIT extra Art. RN 30,50€

REMOTE FITTINGS Art. REM 42,10€
Tapping centres: at the rear of radiator ▲▽ EG
DISTANT Valves page 274

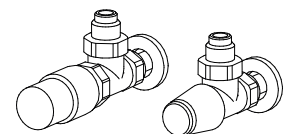

ANGLED TON VALVES KIT with THERMOSTATIC
Head, page 269 Art. KTS 190,30€

LAME-UP

design Davide Brembilla

LAME-Up is free-standing radiator designed by Davide Brembilla, its heating body

acting like a totem pole in the centre of a room. The fins, arranged vertically, produce

a new, versatile and highly functional way to exploit the available volumes.

DIMENSIONS

H from floor: 200 / 230 cm

L: 15 cm

Depth: 19 / 23 / 27 / 31 cm

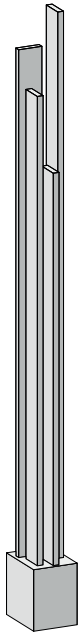

LAME-UP 4

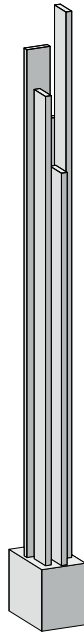

LAME-UP 5

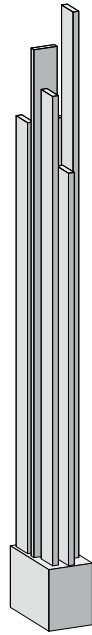

LAME-UP 6

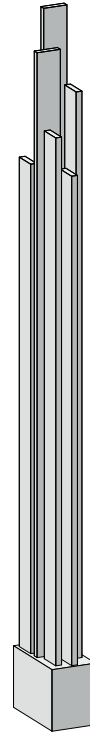

LAME-UP 7

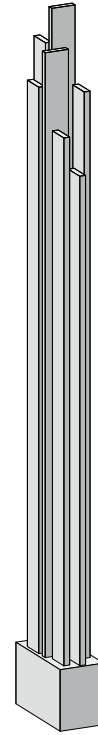

LAME-UP 8

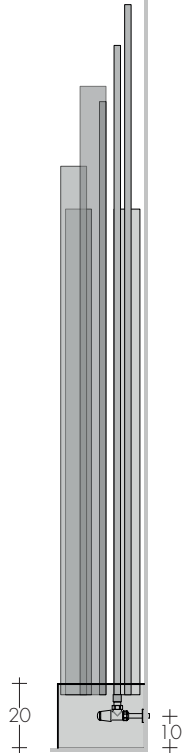

MODEL	H - n° cm tubes	Standard white sablé SB 9016 €	EN 442			▲ ▼ t.c. cm	Height cm	Width cm	Depth cm	Weight M Kg	Volume V dm³	DUAL FUEL VERSION with E.H.E. and sleeve Watt €	
			Δt 50 K watt	Δt 40 K watt	Δt 30 K watt							Watt	€
LAME-UP 200-4	200-4	1032,60	641	473	333	9	200	15	19	18,9	8,0	650	131,80
LAME-UP 200-5	200-5	1279,00	809	597	421	9	200	15	23	23,7	10,1	800	136,60
LAME-UP 200-6	200-6	1449,80	935	690	486	9	200	15	27	27,3	11,7	900	140,20
LAME-UP 200-7	200-7	1645,30	1082	799	563	9	200	15	27	31,5	13,5	-	-
LAME-UP 200-8	200-8	1862,70	1250	923	650	9	200	15	31	36,3	15,6	1200	148,50
LAME-UP 230-4	230-4	1119,20	767	566	399	9	230	15	19	22,5	9,6	800	136,60
LAME-UP 230-5	230-5	1381,20	966	713	502	9	230	15	23	28,2	12,0	900	140,20
LAME-UP 230-6	230-6	1572,40	1124	830	584	9	230	15	27	32,7	14,0	1200	148,50
LAME-UP 230-7	230-7	1782,50	1302	961	677	9	230	15	27	37,8	16,2	1200	148,50
LAME-UP 230-8	230-8	2010,00	1502	1108	781	9	230	15	31	43,5	18,7	1500	159,40

▶ Available in Stock

Δt different from 50 K: consult technical data Brem

Thermostats p.208-209

FREESTANDING VERSION

Fittings on floor (t.c. ▲ ▼ 9 cm)

e.g. LAME-UP 200-4, EG ø 1/2", SB9005

Extra

Art. Lame-UPC 136,90€

STANDARD PRODUCTION

White "sablé" SB9016 paintwork

Tolerance ± 3mm - Air vent ø 1/8"

MAXIMUM OPERATING PRESSURE 4 BAR

PRODUCTION ON REQUEST

Paintwork to Brem color list +15/25%

n.1 spotlight LED 1 W Art. F.LED1 65,00€

n.2 spotlight LEDS 1 W Art. F.LED2 108,20€

STANDARD FITTINGS

EG ø 1/2"

Electric version e.lame-UP p. 243



TAPPING CENTRES ▲▽ = 9 cm

Standard position
on the short side

Position on the long side
Art. LAME-UPL 72,50€
(extra)

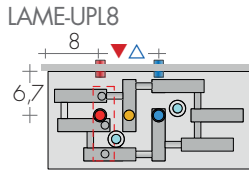
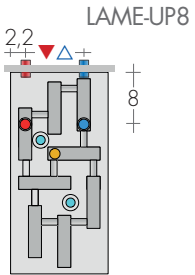
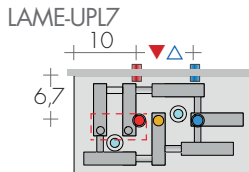
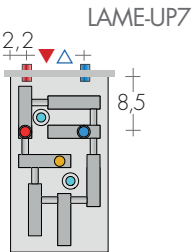
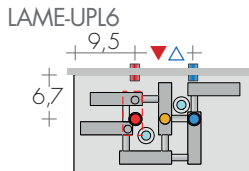
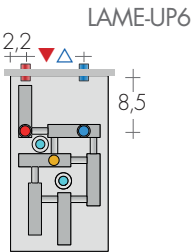
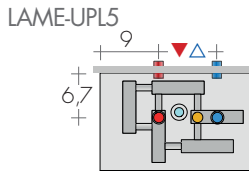
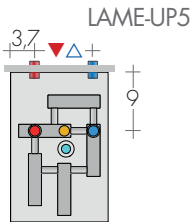
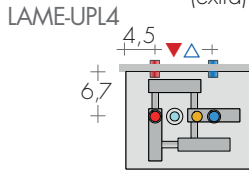
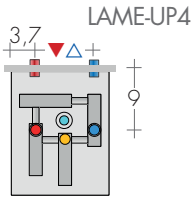

- Delivery
- Return
- Electric Heating Element
- LED on request



LAME-UP 200-4

RECOMMENDED VALVES

CHROME VALVES KIT with:

- n°2 Valves with tailpieces
- n°2 Fittings (multilayer ø16, copper ø12, 14)
- n°2 Chrome wall plates ø 48, hole ø16

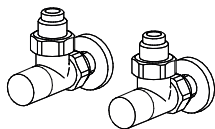

ANGLED MINI VALVES KIT
Art. KMS

page 270
124,00€

WALL POSITION
with angled valves



FREESTANDING POSITION
Art. LAME-UPC with straight valves



HERG

design Luigi Brembilla

HERG is a new radiator with parallel steel fins rising from the floor up to the ceiling and

set at a distance of either 50 or 80 mm, as requested. It features large rectangular tubes

arranged in regular patterns altering the heat output depending on their step and height.

DIMENSIONS

H (HG/HGB): 177/197/217/237/257 cm

(HGS): 180/200/220/240 cm

Width: from 17 to 98 cm

Depth: 12 cm

Element STEP 50 (PE50)



Element STEP 80 (PE80)

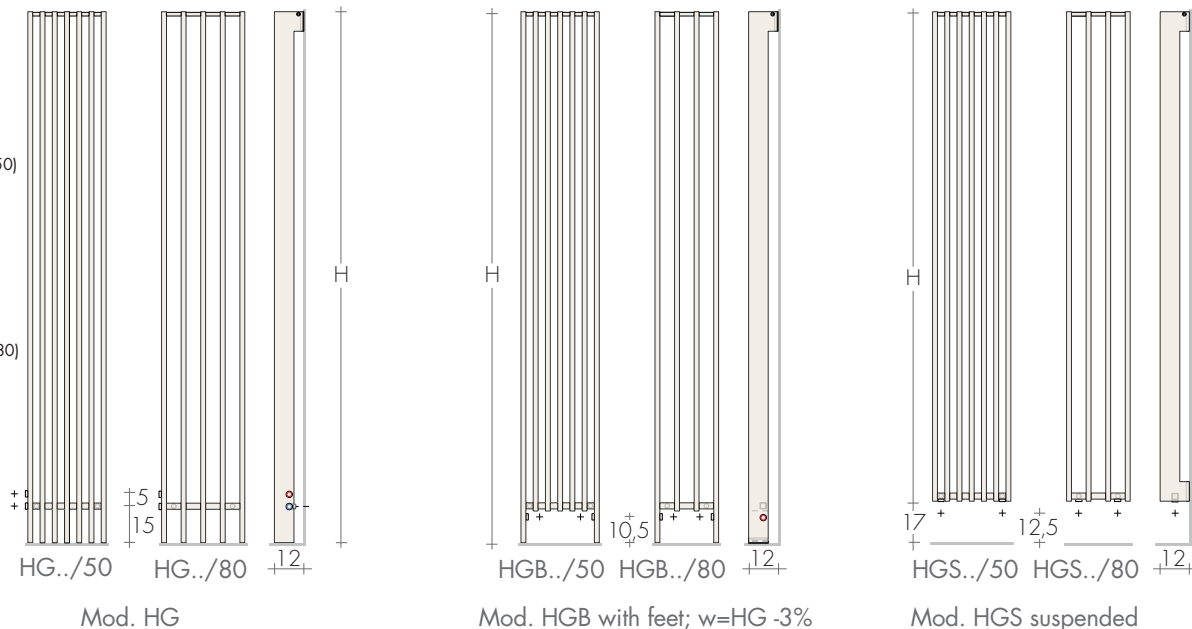

MOD'25	n°elements step mm	4		5		6		7		8		9		10		11		12		13	
		L cm	w	L cm	w	L cm	w	L cm	w	L cm	w	L cm	w	L cm	w	L cm	w	L cm	w	L cm	w
HG..177/..		€ 790,90	540 638	€ 901,00	675 798	€ 1011,20	810 957	€ 1121,30	945 1117	€ 1231,40	1080 1276	€ 1341,50	1215 1436	€ 1451,60	1350 1595	€ 1561,60	1485 1755	€ 1671,70	1620 1914	€ 1781,90	1755 2074
HG..197/..		€ 825,90	601 710	€ 940,40	751 888	€ 1054,70	901 1065	€ 1169,30	1051 1243	€ 1283,70	1202 1420	€ 1398,30	1352 1598	€ 1512,60	1502 1775	€ 1627,10	1652 1953	€ 1741,50	1802 2130	€ 1855,80	1953 2308
HG..217/..		€ 860,80	662 782	€ 979,80	828 978	€ 1098,30	993 1173	€ 1217,20	1159 1369	€ 1336,00	1324 1564	€ 1454,90	1490 1760	€ 1573,60	1655 1955	€ 1692,30	1821 2151	€ 1811,20	1986 2346	€ 1930,10	2152 2542
HG..237/..		€ 895,70	723 854	€ 1018,90	904 1068	€ 1142,10	1084 1282	€ 1265,20	1265 1495	€ 1388,20	1446 1709	€ 1511,40	1626 1922	€ 1634,50	1807 2136	€ 1757,70	1988 2350	€ 1880,80	2168 2563	€ 2004,00	2349 2777
HG..257/..		€ 930,70	784 926	€ 1058,20	980 1158	€ 1185,60	1176 1390	€ 1313,00	1372 1621	€ 1440,70	1568 1853	€ 1568,10	1764 2084	€ 1695,60	1960 2316	€ 1823,00	2156 2548	€ 1950,50	2352 2779	€ 2077,50	2548 3011
HGS 180/..		€ 851,40	574 678	€ 976,60	717 847	€ 1102,00	860 1016	€ 1227,20	1004 1186	€ 1352,40	1147 1355	€ 1477,60	1291 1525	€ 1602,80	1434 1694	€ 1727,90	1577 1863	€ 1853,20	1721 2033	€ 1978,50	1864 2202
HGS 200/..		€ 886,40	634 750	€ 1016,00	793 937	€ 1145,40	952 1124	€ 1275,10	1110 1312	€ 1404,70	1269 1499	€ 1534,40	1427 1687	€ 1663,80	1586 1874	€ 1793,50	1745 2061	€ 1922,90	1903 2249	€ 2052,40	2062 2436
HGS 220/..		€ 921,30	696 822	€ 1055,40	870 1028	€ 1189,00	1043 1233	€ 1323,10	1217 1439	€ 1457,00	1391 1644	€ 1591,00	1565 1850	€ 1724,80	1739 2055	€ 1858,60	1913 2261	€ 1992,60	2087 2466	€ 2126,70	2261 2672
HGS 240/..		€ 956,10	756 894	€ 1094,50	946 1118	€ 1232,80	1135 1341	€ 1371,00	1324 1565	€ 1509,20	1513 1788	€ 1647,50	1702 2012	€ 1785,70	1891 2235	€ 1924,00	2080 2459	€ 2062,30	2269 2682	€ 2200,60	2458 2906

Intermediate heights, every 10 cm, by interpolation. Made-to-measure heights on request.

Δt different from 50 K: consult technical data Brem

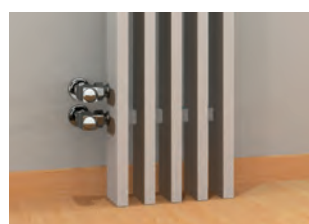

Mod. HG

E.g. : HG 197/50-5el AC 1/2"

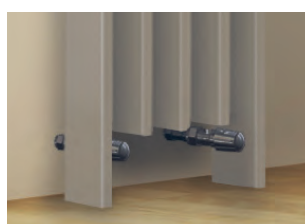

Mod. HGB

E.g. : HGB 197/80-5el REG 1/2"



Mod. HGS

E.g. : HGS 180/50-10el EG 1/2"

STANDARD PRODUCTION

White sablé SB9016 paintwork with brackets

Tolerance ± 3mm - Air vent ø 1/8"

MAXIMUM OPERATING PRESSURE 4 BAR

PRODUCTION ON REQUEST

Paintwork to Brem color list (with colored

brackets) +15/25%

Electric version mod. e.HGS p.235

STANDARD FITTING

AC ø 1/2" - BD on request

Mod. HGB: REG ø 1/2"

Mod. HGS: EG ø 1/2"



TAPPING CENTRES MOD. HG

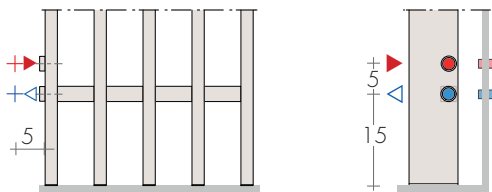

Standard side fittings in AC ▲▽= 5 cm
in BD (right) fitting on request without extra, p. 278

TAPPING CENTRES MOD. HGB

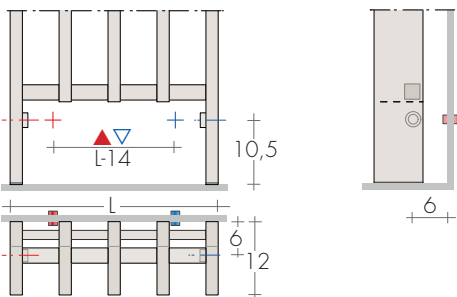

REG fittings, from L>21 cm, with angled valves
from L>30cm with angled valves or reverse valves
Mod. HGB ..-4el.(L=17cm) only fittings AC

TAPPING CENTRES MOD. HGS

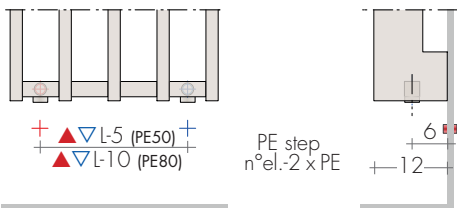

PE step
n°el.-2 x PE

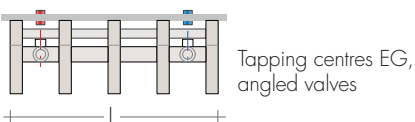

Tapping centres EG,
angled valves

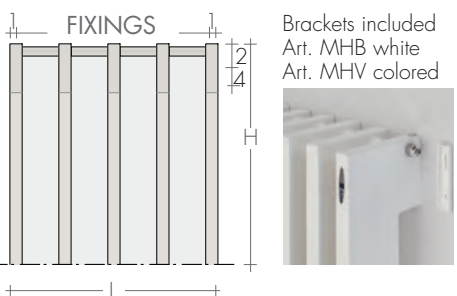

Brackets included
Art. MHB white
Art. MHV colored



HERG HG 237-5el

RECOMMENDED VALVES

CHROME VALVES KIT with:

- n°2 Valves with tailpieces
- n°2 Fittings (multilayer ø16, copper ø12, 14)
- n°2 Chrome wall plates ø 48, hole ø16

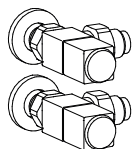

ANGLED QUADRA VALVES KIT
page 271 Art. KQS 180,10€
Extra for BREM color list 53,40€

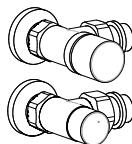

ANGLED CYL VALVES KIT with THERMOSTATIC
option, page.273 Art. KCS 149,90€
Extra for BREM color list 53,40€

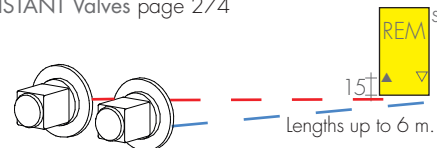

SPECIAL FINISHES page 267
Finishes Gold, Bronze, Brushed Nickel for 2 valves
Brushed Nickel FITTING KIT extra Art. RN 30,50€

REMOTE FITTINGS Art. REM 42,10€
Tapping centres: at the rear of radiator ▲▽ EG
DISTANT Valves page 274

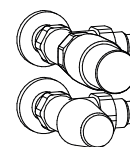

ANGLED TON VALVES KIT with THERMOSTATIC
Head, page 269 Art. KTS 190,30€

META

META is constructed with the columns welded to the section of the manifold with an ES

(element step) that can be varied from 30 to 70 mm at 5 mm intervals.

The heating element can be composed using columns of 50 or 70 mm depth.

LAME

DIMENSIONS

Width: from 10,5 cm to 6m

Height: from 21 to 220 cm

Depth: M1000: 8,2/10,2 cm
M2000: 12,9/16,9 cm

Depth from wall: M1000: 11,5/13,5 cm
M2000: 15,5/19,5 cm

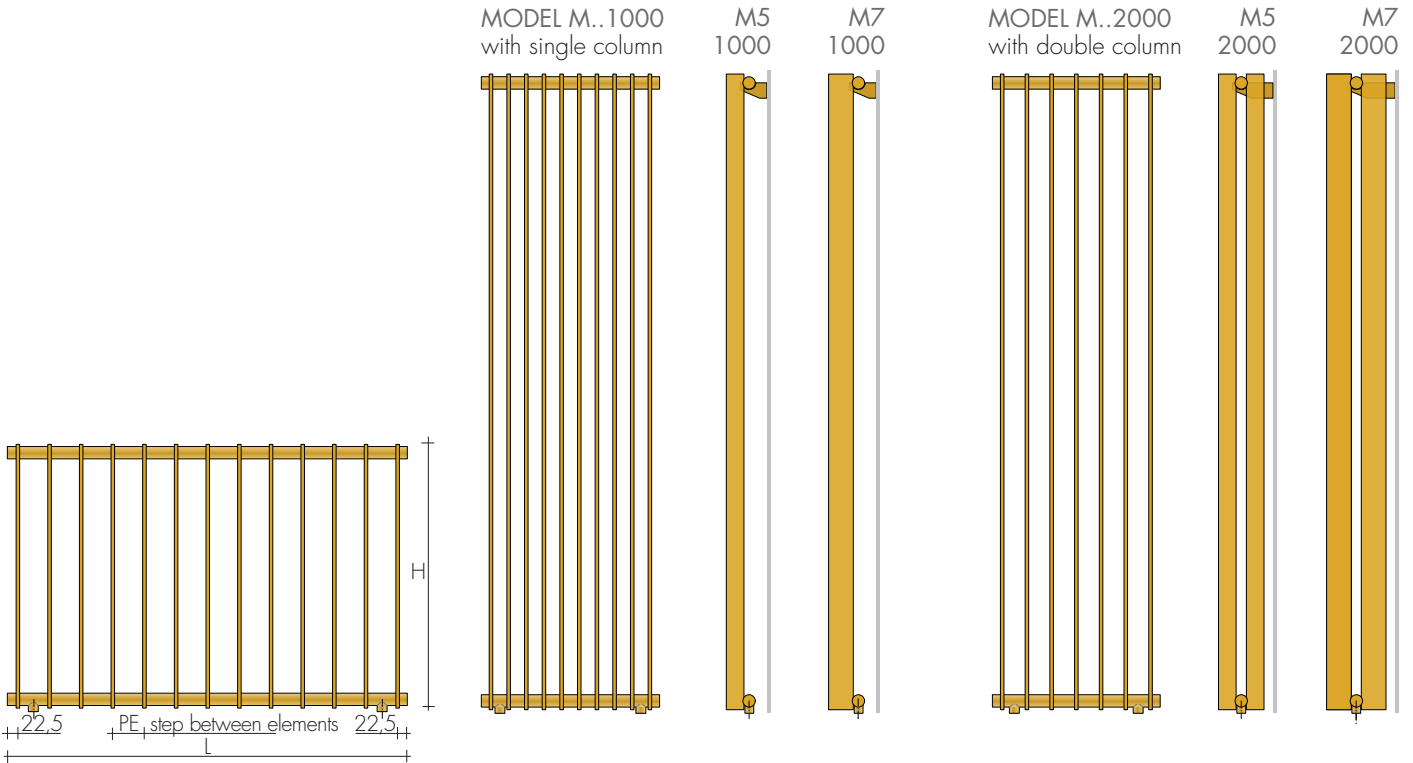

Widths from 3 elements to 6 m
 $L = (\text{no. of elements} - 1) \times \text{PE (step)} + 45 \text{ mm}$
 PE = step between elements:
 30 - 35 - 40 - 45 - 50 - 55 - 60 - 65 - 70 mm

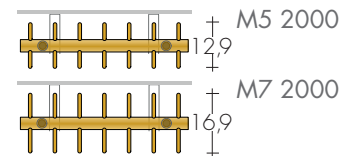
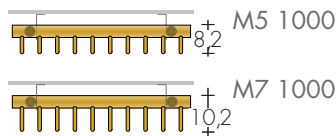

STANDARD PRODUCTION

White sablé SB9016 paintwork white brackets
 Tolerance $\pm 3 \text{ mm}$ - Air vent $\varnothing 3/8''$

MAXIMUM OPERATING PRESSURE 6 BAR

PRODUCTION ON REQUEST

Paintwork to Brem color list with colored brackets +15/25%

Special versions, by estimate H max 2,2 m

STANDARD FITTING

EG $\varnothing 1/2''$

Special fittings page 278

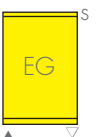

TAPPING CENTRES

MODEL M..1000 with single column
standard fittings EG ø1/2"

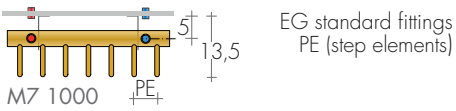
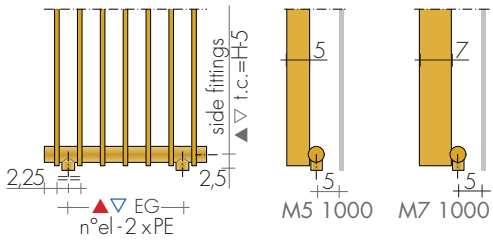

MODEL M..2000 with double column
standard fittings EG ø1/2"

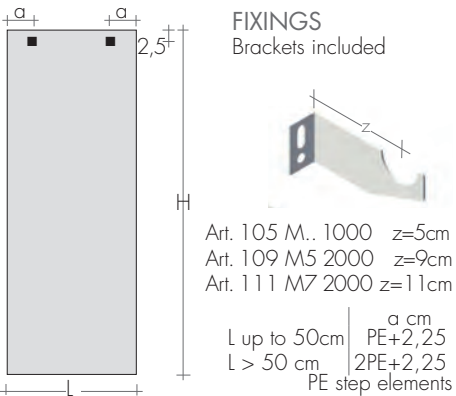
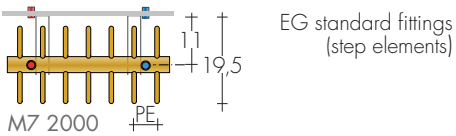
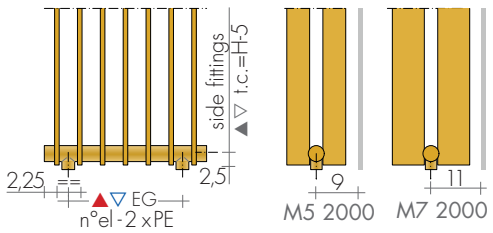

META M5 1220/50-10 el

RECOMMENDED VALVES

CHROME VALVES KIT with:

- n°2 Valves with tailpieces
- n°2 Fittings (multilayer ø16, copper ø12, 14)
- n°2 Chrome wall plates ø 48, hole ø16

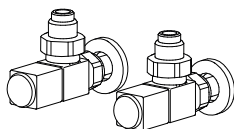

ANGLED QUADRA VALVES KIT
page 271 Art. KQS 180,10€
Extra for BREM color list 53,40€

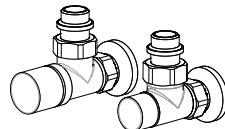

ANGLED CYL VALVES KIT with THERMOSTATIC
option, page.273 Art. KCS 149,90€
Extra for BREM color list 53,40€

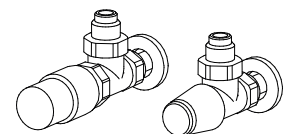

ANGLED TON VALVES KIT with THERMOSTATIC
Head, page 269 Art. KTS 190,30€

SPECIAL FINISHES

page 267
Finishes Gold, Bronze, Brushed Nickel for 2 valves
Brushed Nickel FITTING KIT extra Art. RN 30,50€

FIXED FOOT

META feet are built from the heating element's tube
and welded to the radiator (H=15cm)

M 1000 Art. P1N 139,90€
M 2000 (in the middle) Art. P1N 139,90€

META M7 STEP 50 SINGLE COLUMN

LAME

M7 MODEL	(n° el)	10 el.	12 el.	14 el.	16 el.	18 el.	20 el.	22 el.	24 el.	26 el.	28 el.	30 el.
LOW	L cm	49,5	59,5	69,5	79,5	89,5	99,5	109,5	119,5	129,5	139,5	149,5
	H cm	▲▽ 40	50	60	70	80	90	100	110	120	130	140
M7 1050/50	€	295,00	333,60	372,00	410,70	449,10	487,60	526,10	564,80	603,20	641,90	680,30
	w	372w	446w	521w	595w	670w	744w	818w	893w	967w	1042w	1116w
M7 1060/50	€	313,30	353,90	394,30	434,90	475,40	516,00	556,60	597,10	637,70	678,30	718,90
	w	438w	526w	613w	701w	788w	876w	964w	1051w	1139w	1226w	1314w
M7 1075/50	€	346,50	393,90	441,00	488,30	535,40	582,70	629,90	677,10	724,40	771,50	818,90
	w	530w	636w	742w	848w	954w	1060w	1166w	1272w	1378w	1484w	1590w
M7 1090/50	€	371,20	423,20	475,40	527,70	579,70	631,90	684,00	736,20	788,20	840,50	892,70
	w	636w	763w	890w	1018w	1145w	1272w	1399w	1526w	1654w	1781w	1908w

EN 442 Watt Δt 50K (Δt 40K = Wx0,755) (Δt 30K = Wx0,526)

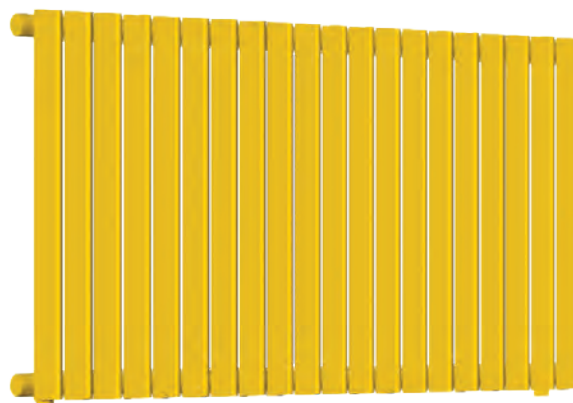

META 1000

M7 MODEL	(n° el)	5 el.	6 el.	7 el.	8 el.	9 el.	10 el.	11 el.	12 el.	13 el.	14 el.	15 el.
HIGH	L cm	24,5	29,5	34,5	39,5	44,5	49,5	54,5	59,5	64,5	69,5	74,5
	H cm	▲▽ 15	20	25	30	35	40	45	50	55	60	65
M7 1160/50	€	320,60	362,50	404,60	446,40	488,50	530,40	572,70	614,70	656,70	698,60	740,60
	w	535W	642W	749W	856W	964W	1070W	1177W	1284W	1391W	1499W	1605W
M7 1180/50	€	342,80	389,40	435,90	482,50	529,00	575,50	621,90	668,50	714,80	761,40	808,00
	w	602w	722w	843w	963w	1084w	1204w	1324w	1445w	1565w	1686w	1806w
M7 1200/50	€	364,70	415,40	466,20	517,20	568,10	619,00	669,80	720,60	771,40	822,40	873,10
	w	652w	782w	912w	1042w	1173w	1303w	1433w	1564w	1694w	1824w	1955w
M7 1220/50	€	400,10	458,20	516,00	574,00	631,90	689,90	747,80	805,80	863,80	921,60	979,70
	w	715w	857w	1000w	1143w	1286w	1429w	1572w	1715w	1858w	2001w	2144w

Δt different, consult Technical data Brem

All sizes listed on pages 20-21

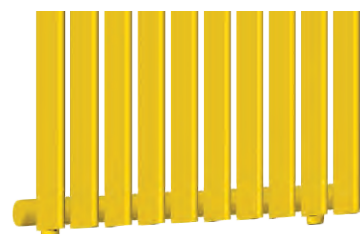
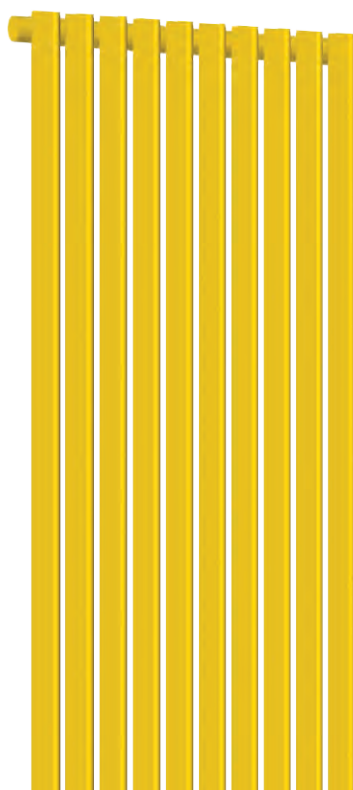

Model META column depth single column H cm step mm no. el
M 7 1 200/50- 8 el

META 1000

META M7 STEP 50 DOUBLE COLUMN

M7 MODEL	(n° el)	10 el.	12 el.	14 el.	16 el.	18 el.	20 el.	22 el.	24 el.	26 el.	28 el.	30 el.
LOW	L cm	49,5	59,5	69,5	79,5	89,5	99,5	109,5	119,5	129,5	139,5	149,5
H cm	▲▼	40	50	60	70	80	90	100	110	120	130	140
M7 2050/50	€	517,60	593,60	669,90	746,10	822,40	898,40	974,60	1051,00	1127,10	1203,20	1279,50
H 50	w	627w	752w	878w	1003w	1129w	1254w	1379w	1505w	1630w	1756w	1881w
M7 2060/50	€	563,80	649,30	734,90	820,20	905,70	991,30	1076,70	1162,20	1247,60	1333,10	1418,60
H 60	w	741w	889w	1037w	1186w	1334w	1482w	1630w	1778w	1927w	2075w	2223w
M7 2075/50	€	630,40	729,40	828,00	927,00	1025,70	1124,60	1223,30	1322,00	1420,80	1519,70	1618,50
H 75	w	911w	1093w	1275w	1458w	1640w	1822w	2004w	2186w	2369w	2551w	2733w
M7 2090/50	€	700,00	812,80	925,30	1038,10	1150,80	1263,50	1376,20	1489,00	1601,60	1714,40	1827,10
H 90	w	1091w	1309w	1527w	1746w	1964w	2182w	2400w	2618w	2837w	3055w	3273w

EN 442 W_{eff} Δt 50K (Δt 40K = Wx0,755) (Δt 30K = Wx0,526)

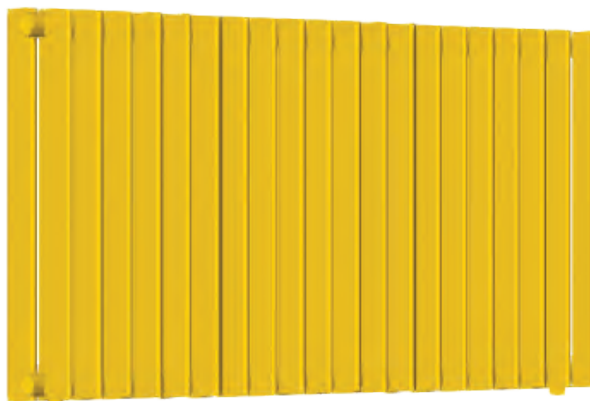

META 2000

M7 MODEL	(n° el)	5 el.	6 el.	7 el.	8 el.	9 el.	10 el.	11 el.	12 el.	13 el.	14 el.	15 el.
HIGH	L cm	24,5	29,5	34,5	39,5	44,5	49,5	54,5	59,5	64,5	69,5	74,5
H cm	▲▼	15	20	25	30	35	40	45	50	55	60	65
M7 2160/50	€	577,50	665,90	753,90	842,40	930,50	1018,80	1107,00	1195,30	1283,40	1371,60	1459,80
H 160	w	927W	1112W	1298W	1483W	1668W	1853W	2039W	2224W	2410W	2595W	2780W
M7 2180/50	€	623,30	720,60	817,90	915,30	1012,60	1109,90	1207,50	1304,80	1402,10	1499,50	1596,80
H 180	w	1043w	1251w	1460w	1668w	1877w	2085w	2294w	2502w	2711w	2919w	3128w
M7 2200/50	€	668,80	775,60	881,80	988,30	1094,80	1201,30	1307,60	1414,30	1520,80	1627,30	1733,60
H 200	w	1157w	1388w	1620w	1851w	2083w	2314w	2545w	2777w	3008w	3240w	3471w
M7 2220/50	€	713,70	829,30	944,60	1060,30	1175,60	1291,20	1406,50	1521,90	1637,50	1752,80	1868,40
H 220	w	1272w	1526w	1780w	2034w	2289w	2543w	2797w	3052w	3306w	3560w	3815w

Δt different, consult Technical data Brem

All sizes listed on pages 20-21

HOW TO ORDER

State: model, column (whether single or double), height in cm, step in mm, number of elements; fitting and color
e.g.: M7 2 200-70 6 el, AC Ø 1/2" BR0033

Model META column depth double column H cm step mm no. el
M 7 2 180/50- 14el

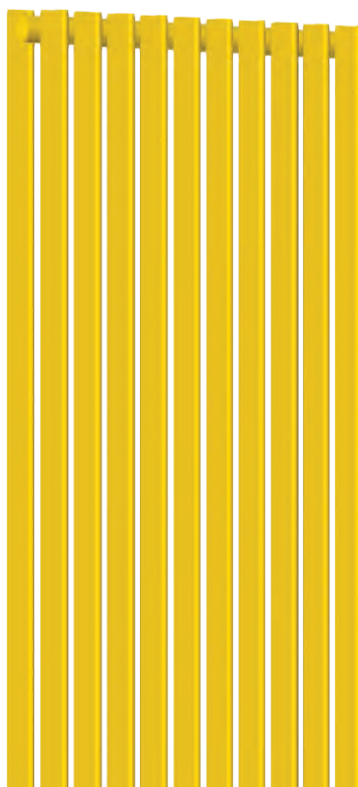

META 2000

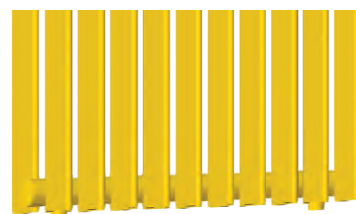

META 1000

FULL LIST OF THERMAL OUTPUTS AND PRICES

MOD.	step	PE	..-30		..-35		..-40		..-45		..-50		..-55		..-60		..-65		..-70		PRICE		
			M5	M7	M5	M7	M5	M7	M5	M7	M5	M7	M5	M7	M5	M7	M5	M7	M5	M7	element	fixed price	
		column																			€ x n°el.	€	
		H	w/el.	w/el.	w/el.	w/el.	w/el.	w/el.	w/el.	w/el.	w/el.	w/el.	w/el.	w/el.	w/el.	w/el.	w/el.	w/el.	w/el.	w/el.	w/el.		
M..1030..			18,6	21,6	19,3	22,4	20,0	23,2	20,9	24,0	21,7	24,8	22,5	25,7	23,3	26,6	24,1	27,4	24,9	28,1	16,7	102,2	
M..1035..			20,9	25,1	21,7	25,9	22,5	26,8	23,4	27,7	24,2	28,5	25,0	29,4	25,8	30,3	26,6	31,1	27,4	31,9	17,1	102,3	
M..1040..			23,0	27,1	23,8	28,1	24,7	29,0	25,6	29,8	26,5	30,5	27,3	31,7	28,2	32,9	29,0	33,9	29,9	34,9	17,7	102,3	
M..1045..			25,7	30,1	26,6	31,0	27,4	32,0	28,2	33,1	29,1	34,2	29,8	35,0	30,6	35,8	31,4	37,2	32,2	38,6	18,4	102,3	
M..1050..			28,0	32,3	28,9	33,6	29,8	34,9	30,7	36,0	31,6	37,2	32,5	38,4	33,3	39,5	34,1	40,6	35,0	41,6	19,3	102,4	
M..1055..			30,9	35,3	31,8	36,6	32,8	37,9	33,7	39,4	34,6	40,8	35,4	41,7	36,2	42,5	37,1	43,9	38,0	45,3	19,6	102,5	
M..1060..			33,0	38,2	34,0	39,5	35,0	40,8	35,9	42,3	36,9	43,8	37,8	45,0	38,6	46,2	39,5	47,2	40,5	48,3	20,3	110,5	
M..1065..			35,3	41,0	36,4	42,4	37,4	43,8	38,5	45,6	39,6	47,5	40,6	48,3	41,6	49,2	42,6	50,6	43,6	52,0	21,4	110,6	
M..1070..			37,3	43,2	38,5	45,0	39,8	46,7	41,0	48,6	42,2	50,4	43,4	51,7	44,5	52,9	45,7	54,3	46,9	55,7	22,5	110,5	
M..1075..			39,6	46,1	40,8	47,9	42,1	49,7	43,4	51,5	44,7	53,3	45,9	54,6	47,0	55,9	48,3	57,3	49,5	58,6	23,6	110,3	
M..1080..			42,3	49,0	43,5	50,8	44,8	52,6	46,0	54,8	47,2	57,0	48,2	58,3	49,3	59,6	50,5	61,0	51,7	62,3	24,8	110,5	
M..1090..			46,8	55,7	48,3	57,4	49,7	59,2	51,2	61,4	52,7	63,6	54,0	64,9	55,3	66,2	56,7	67,6	58,2	69,0	26,1	110,5	
M..1100..			52,6	61,3	54,0	63,2	55,4	65,1	56,7	67,2	58,1	69,4	59,3	71,1	60,4	72,8	61,8	74,3	63,1	75,7	28,1	110,5	
M..1110..			57,6	67,1	59,0	69,0	60,5	70,9	62,0	73,4	63,5	75,9	64,8	77,7	66,0	79,5	67,5	81,3	69,0	83,1	30,7	110,6	
M..1120..			61,9	72,2	63,5	74,5	65,1	76,7	66,7	79,6	68,3	82,4	69,6	84,3	71,0	86,1	72,6	87,9	74,2	89,7	32,7	110,4	
M..1150..			77,7	88,7	79,5	91,4	81,3	94,2	83,1	97,7	84,9	101,1	86,3	103,5	87,8	105,9	89,6	107,8	91,5	109,6	38,4	110,6	
M..1160..			81,2	93,7	83,3	96,8	85,4	99,9	87,6	103,8	89,7	107,6	91,5	110,0	93,2	112,5	95,4	114,7	97,6	117,0	42,0	110,3	
M..1175..			89,2	103,0	91,3	106,2	93,5	109,3	95,6	113,1	97,8	116,9	99,5	119,4	101,2	122,0	103,5	124,3	105,8	126,6	44,2	110,5	
M..1180..			92,1	106,0	94,2	109,1	96,4	112,2	98,6	116,3	100,8	120,4	102,6	123,0	104,3	125,6	106,6	127,9	108,9	130,3	46,5	110,5	
M..1190..			97,1	111,8	99,4	114,8	101,7	117,9	104,1	120,9	106,4	124,0	108,2	128,1	110,0	132,3	112,5	135,8	114,9	139,3	48,8	110,6	
M..1200..			102,2	117,6	104,6	120,8	107,0	124,0	109,5	127,1	111,9	130,3	113,8	134,7	115,7	139,1	118,4	142,9	121,0	146,6	50,9	110,5	
M..1210..			107,2	123,4	109,8	126,7	112,3	130,1	114,9	133,4	117,5	136,6	119,5	141,3	121,5	146,0	124,2	149,9	127,0	153,9	53,3	110,4	
M..1220..			112,2	129,2	114,9	132,7	117,6	136,1	120,3	139,5	123,1	142,9	125,1	147,9	127,2	152,8	130,1	157,0	133,1	161,2	57,9	110,5	

The radiator heat output is determined by multiplying the heat output of a single column by the number of elements.

The cost of the column is determined only by its height and does not depend on its depth or step between elements.

The cost of the radiator is determined by multiplying the unit price of one column by the number of elements and then adding this to the fixed price.

Model META column depth single column H cm step mm no. el.

M 7 1200/70- 8 el

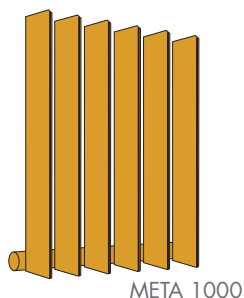

How to choose the META radiator
Given the number of Watts necessary to heat a room (e.g. 1175 W) with a radiator at a height of 200 cm, find the number of elements by varying the step as required by the space available:

MODEL	el.	l(cm)	W	€
M7 1200/70	8	53,5	1173	517,70
M7 1200/50	9	44,5	1173	568,60
M7 1200/30	10	31,5	1176	619,50

WIDTHS OF RADIATORS

element step	number of elements														
	5 el	6 el	7 el	8 el	9 el	10 el	11 el	12 el	13 el	14 el	15 el	16 el	17 el	18 el	19 el
M.../30 L cm	16,5	19,5	22,5	25,5	28,5	31,5	34,5	37,5	40,5	43,5	46,5	49,5	52,5	55,5	58,5
M.../35 L cm	18,5	22,0	25,5	29,0	32,5	36,0	39,5	43,0	46,5	50,0	53,5	57,0	60,5	64,0	67,5
M.../40 L cm	20,5	24,5	28,5	32,5	36,5	40,5	44,5	48,5	52,5	56,5	60,5	64,5	68,5	72,5	76,5
M.../45 L cm	22,5	27,0	31,5	36,0	40,5	45,0	49,5	54,0	58,5	63,0	67,5	72,0	76,5	81,0	85,5
M.../50 L cm	24,5	29,5	34,5	39,5	44,5	49,5	54,5	59,5	64,5	69,5	74,5	79,5	84,5	89,5	94,5
M.../55 L cm	26,5	32,0	37,5	43,0	48,5	54,0	59,5	65,0	70,5	76,0	81,5	87,0	92,5	98,0	103,5
M.../60 L cm	28,5	34,5	40,5	46,5	52,5	58,5	64,5	70,5	76,5	82,5	88,5	94,5	101,0	107,0	113,0
M.../65 L cm	30,5	37,0	43,5	50,0	56,5	63,0	69,5	76,0	82,5	89,0	95,5	102,0	108,5	115,0	121,5
M.../70 L cm	32,5	39,5	46,5	53,5	60,5	67,5	74,5	81,5	88,5	95,5	102,5	109,5	116,5	123,5	130,5

META 2000

FULL LIST OF THERMAL OUTPUTS AND PRICES

MOD.	step PE	..30		..35		..40		..45		..50		..55		..60		..65		..70		PRICE		
		column	M5	M7	M5	M7	M5	M7	M5	M7	M5	M7	M5	M7	M5	M7	M5	M7	M5	M7	element	fixed price
H		w/el.	w/el.	w/el.	w/el.	w/el.	w/el.	w/el.	w/el.	w/el.	w/el.	w/el.	w/el.	w/el.	w/el.	w/el.	w/el.	w/el.	w/el.	w/el.	€ x n°el.	+ €
M..2030..		31,0	36,2	32,1	37,3	33,3	38,5	34,5	39,7	35,7	40,9	36,9	42,1	38,0	43,3	39,1	44,3	40,2	45,3	30,4	143,0	
M..2035..		35,6	42,8	36,8	44,0	38,0	45,2	39,1	46,4	40,3	47,5	41,3	48,7	42,3	49,8	43,3	50,8	44,3	51,7	33,0	142,9	
M..2040..		39,4	46,5	40,7	47,9	41,9	49,2	43,2	50,5	44,4	51,8	45,5	53,1	46,5	54,4	47,6	55,5	48,7	56,6	33,6	142,9	
M..2045..		44,4	51,9	45,6	53,3	46,7	54,7	47,8	56,1	49,0	57,5	49,9	58,9	50,9	60,4	51,9	61,5	52,9	62,7	36,1	136,3	
M..2050..		48,4	55,9	49,7	57,6	51,0	59,4	52,3	61,1	53,5	62,7	54,6	64,5	55,7	66,3	56,8	67,8	58,0	69,2	38,1	136,7	
M..2055..		53,7	61,2	55,0	63,0	56,3	64,9	57,5	66,7	58,8	68,4	59,9	70,4	61,0	72,3	62,2	73,9	63,3	75,4	40,4	136,5	
M..2060..		57,5	66,4	58,9	68,3	60,3	70,3	61,7	72,2	63,0	74,1	64,2	76,2	65,4	78,2	66,7	79,9	67,9	81,6	42,7	136,4	
M..2065..		61,6	71,6	63,2	73,8	64,8	75,8	66,4	78,0	68,0	80,1	69,4	82,4	70,7	84,6	72,2	86,5	73,7	88,3	44,8	136,4	
M..2070..		65,3	75,6	67,2	78,1	69,1	80,6	71,0	83,1	72,9	85,5	74,5	88,2	76,1	90,9	77,9	93,1	79,6	95,3	47,4	136,6	
M..2075..		69,4	80,9	71,5	83,5	73,5	86,0	75,5	88,6	77,5	91,1	79,2	93,9	80,9	96,7	82,8	99,1	84,7	101,4	49,4	136,4	
M..2080..		74,6	86,3	76,5	89,1	78,4	91,8	80,2	94,5	82,1	97,2	83,7	100,2	85,3	103,2	87,1	105,8	88,9	108,3	51,9	136,4	
M..2090..		82,7	98,3	85,1	101,0	87,4	103,7	89,8	106,5	92,1	109,1	94,2	112,2	96,2	115,3	98,5	117,9	100,7	120,5	56,4	136,5	
M..2100..		93,2	108,7	95,5	111,6	97,7	114,5	99,9	117,4	102,1	120,3	103,9	123,7	105,8	127,2	107,9	130,0	110,0	132,7	60,9	136,4	
M..2110..		102,3	119,1	104,7	122,4	107,2	125,5	109,7	128,8	112,1	132,0	114,2	135,8	116,2	139,6	118,6	142,9	121,0	146,1	65,5	136,4	
M..2120..		110,6	129,0	113,1	132,5	115,6	135,9	118,1	139,4	120,6	142,7	122,6	146,8	124,5	150,9	126,9	154,3	129,3	157,6	70,0	136,6	
M..2150..		140,7	160,6	143,1	164,3	145,5	168,0	147,8	171,6	150,2	175,2	151,8	179,9	153,4	184,6	155,7	188,3	157,9	192,1	83,6	136,3	
M..2160..		147,9	170,6	150,7	174,6	153,4	178,5	156,1	182,3	158,8	186,0	160,7	191,0	162,6	196,0	165,2	200,0	167,8	203,9	88,2	136,6	
M..2175..		163,4	188,8	166,0	192,4	168,5	195,9	170,9	199,2	173,3	202,5	174,8	207,2	176,3	212,0	178,6	215,6	180,9	219,2	92,9	136,5	
M..2180..		169,8	195,4	172,1	198,9	174,4	202,3	176,6	205,4	178,8	208,5	180,0	213,3	181,2	217,9	183,3	221,4	185,4	224,7	97,4	136,4	
M..2190..		180,2	207,4	182,4	210,8	184,6	214,0	186,8	217,0	188,8	220,0	189,8	224,7	190,8	229,4	192,8	232,8	194,7	236,0	102,0	136,3	
M..2200..		190,7	219,5	192,8	222,7	194,9	225,8	196,9	228,7	198,8	231,4	199,6	236,2	200,3	240,9	202,2	244,1	203,9	247,1	106,5	136,5	
M..2210..		201,3	231,7	203,3	234,8	205,3	237,7	207,1	240,3	208,9	242,8	209,4	247,6	209,8	252,2	211,5	255,3	213,1	258,2	111,0	136,4	
M..2220..		212,0	244,1	213,9	247,0	215,7	249,6	217,4	252,0	218,9	254,3	219,1	258,9	219,3	263,5	220,7	266,4	222,1	269,1	115,5	136,7	

Δt different from 50 K: consult Technical data Brem

Model META column depth double column height cm step mm n° el

M 7 2 180/70- 20 el

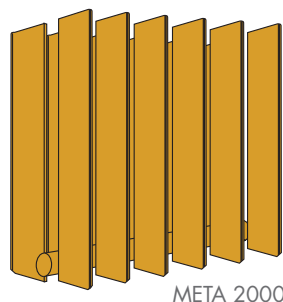

How to choose the META radiator

Given the number of Watts necessary to heat a room (e.g. 1620 W) with a radiator at a height of 75 cm, find the number of elements by varying the step as required by the space available:

MODEL	el.	l(cm)	W	€
M7 2075/70	16	109,5	1622	926,80
M7 2075/50	18	89,5	1640	1025,60
M7 2075/30	20	61,5	1618	1124,40

numbers of elements													Widths with 3 elements only with side fittings	
20 el	21 el	22 el	23 el	24 el	25 el	26 el	27 el	28 el	29 el	30 el	31 el	32 el	MOD.	from 33 el. to 6 m
61,5	64,5	67,5	70,5	73,5	76,5	79,5	82,5	85,5	88,5	91,5	94,5	97,5	M.../30	(n°el -1) x 30 + 45
71,0	74,5	78,0	81,5	85,0	88,5	92,0	95,5	99,0	102,5	106,0	109,5	113,0	M.../35	(n°el -1) x 35 + 45
80,5	84,5	88,5	92,5	96,5	100,5	104,5	108,5	112,5	116,5	120,5	124,5	128,5	M.../40	(n°el -1) x 40 + 45
90,0	94,5	99,0	103,5	108,0	112,5	117,0	121,5	126,0	130,5	135,0	139,5	144,0	M.../45	(n°el -1) x 45 + 45
99,5	104,5	109,5	114,5	119,5	124,5	129,5	134,5	139,5	144,5	149,5	154,5	159,5	M.../50	(n°el -1) x 50 + 45
109,0	114,5	120,0	125,5	131,0	136,5	142,0	147,5	153,0	158,5	164,0	169,5	175,0	M.../55	(n°el -1) x 55 + 45
118,5	124,5	130,5	136,5	142,5	148,5	154,5	160,5	166,5	172,5	178,5	184,5	190,5	M.../60	(n°el -1) x 60 + 45
128,0	134,5	141,0	147,5	154,0	160,5	167,0	173,5	180,0	186,5	193,0	199,5	206,0	M.../65	(n°el -1) x 65 + 45
137,5	144,5	151,5	158,5	165,5	172,5	179,5	186,5	193,5	200,5	207,5	214,5	221,5	M.../70	(n°el -1) x 70 + 45

REGULAR

REGULAR is a new radiator with parallel steel fins set at a distance of either 50 or 80 mm, as requested. It features large rectangular tubes arranged in regular

patterns, altering the heat output depending on their step.

DIMENSIONS

Height: 53/65/75/85/
157/177/197/217/237 cm
Width: from 22 to 202 cm
Depth: 8 cm
Depth from wall: 9,5 cm

ELEMENT STEP 50

L = (n° el. x step 5 cm) - 3 cm

ELEMENT STEP 80

L = (n° el. x step 8 cm) - 6 cm

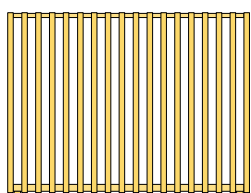

STEP 50

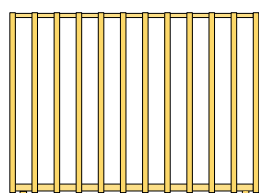

STEP 80

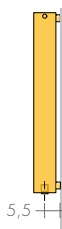

5,5

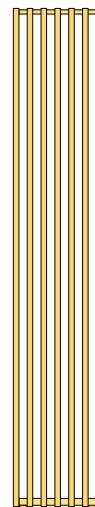

STEP 50

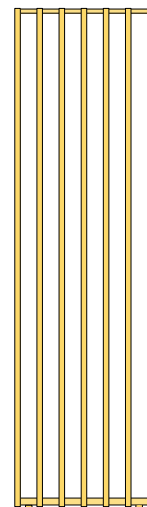

STEP 80

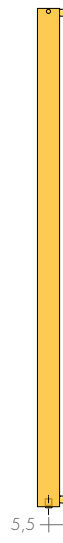

5,5

MOD.	n° el. step mm	EN 442 Watt Δt 50K (Δt 40K = Wx0,755) (Δt 30K = Wx0,526)																						
		8		10		12		14		16		18		20		22		24		25		30		
H cm	L cm	/50	/80	/50	/80	/50	/80	/50	/80	/50	/80	/50	/80	/50	/80	/50	/80	/50	/80	/50	/80	/50	/80	
R 53/.. 53	37 30	58 48	47 40	74 64	57 50	90 80	67 60	106 96	77 70	122 112	87 80	138 128	97 90	154 144	107 100	170 160	117 110	186 176	127 120	202 192	147 140	1540,00 1251		
R 65/.. 65	€	535,90	627,30	718,60	809,80	901,00	992,40	1083,60	1174,90	1266,00	1357,40	1540,00	€	559,20	654,80	750,30	846,00	941,60	1037,30	1133,00	1228,30	1324,20	1419,80	1611,00
R 75/.. 75	w	334 393	417 491	500 589	584 687	667 786	751 884	834 982	917 1080	1001 1178	1084 1277	1251	w	410 482	512 602	614 722	717 843	819 963	922 1084	1024 1204	1126 1324	1229 1445	1331 1565	1536
R 85/.. 85	€	594,00	696,80	799,70	902,60	1005,30	1108,20	1211,10	1314,00	1416,70	1519,70	1725,50	€	628,70	738,80	849,00	959,20	1069,20	1179,10	1289,30	1399,40	1509,50	1619,60	1839,80
	w	472 556	590 695	708 834	826 973	944 1112	1062 1251	1180 1390	1298 1529	1416 1668	1534 1807	1770	w	535 630	669 787	803 944	937 1102	1070 1259	1204 1417	1338 1574	1472 1731	1606 1889	1739 2046	2007

Intermediate or higher values by interpolation

MOD.	n° el. step mm	EN 442 Watt Δt 50K (Δt 40K = Wx0,755) (Δt 30K = Wx0,526)																				
		5		6		7		8		9		10		11		12		13		15		
H cm	L cm	/50	/80	/50	/80	/50	/80	/50	/80	/50	/80	/50	/80	/50	/80	/50	/80	/50	/80	/50	/80	
R 160/..157	22 15	34 24	27 20	42 32	32 25	50 40	37 30	58 48	42 35	66 56	47 40	74 64	52 45	82 72	57 50	90 80	62 55	98 88	72 65	1810,70 1796		
R 180/..177	€	825,70	924,10	1022,70	1121,20	1219,80	1318,10	1416,60	1515,20	1613,70	1810,70	€	864,90	967,60	1070,50	1173,50	1276,40	1379,20	1482,00	1584,90	1687,80	1893,40
R 200/..197	w	599 708	718 849	838 991	958 1132	1077 1274	1197 1415	1317 1557	1436 1698	1556 1840	1796	w	675 798	810 957	945 1117	1080 1276	1215 1436	1350 1595	1485 1755	1620 1914	1755 2074	2025
R 220/..217	€	904,10	1011,40	1118,70	1225,80	1332,90	1440,10	1547,30	1654,70	1761,80	1976,10	€	943,30	1054,90	1166,60	1278,00	1389,60	1501,10	1612,80	1724,10	1835,80	2058,90
R 240/..237	w	828 978	993 1173	1159 1369	1324 1564	1490 1760	1655 1955	1821 2151	1986 2346	2152 2542	2483	w	904 1068	1084 1282	1265 1495	1446 1709	1626 1922	1807 2136	1988 2350	2168 2563	2349 2777	2711

Intermediate heights, every 10 cm, by interpolation. Made-to-measure heights on request.

Δt different from 50 K: consult Technical data Brem

Eg.: R 220/50 - 4el - EG ø 1/2" - SB 3061

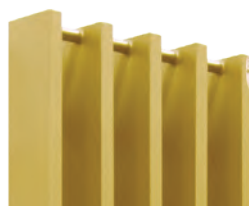

STANDARD PRODUCTION

White sablé SB9016 paintwork - Brackets B15
Tolerance ± 3mm - Air vent ø 1/8"
MAXIMUM OPERATING PRESSURE 4 BAR

PRODUCTION ON REQUEST

Paintwork to Brem color list (colored brackets B15) +15/25%
Electric version, e.Regular p.255

STANDARD FITTING

EG ø 1/2"
On request fittings ø 3/8"
Special fittings, page 278



TAPPING CENTRES

REGULAR STEP 50 mm

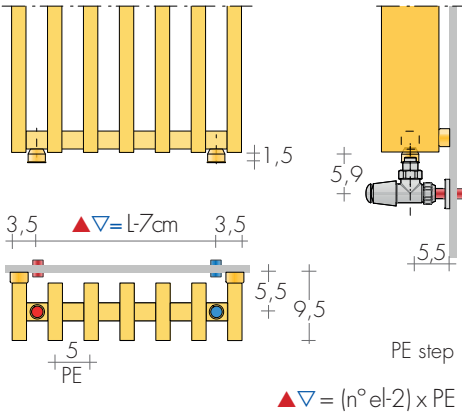

REGULAR STEP 80 mm

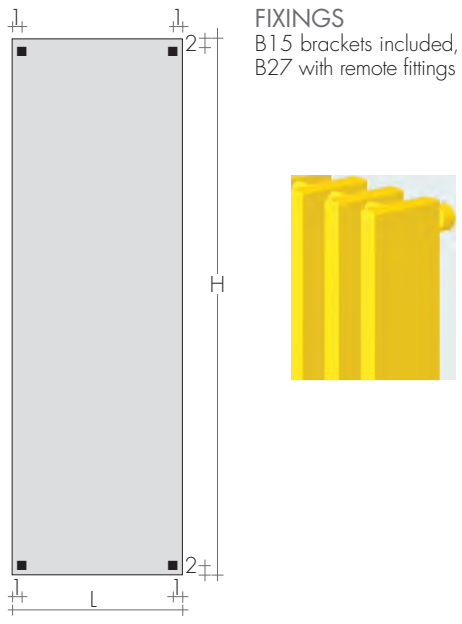
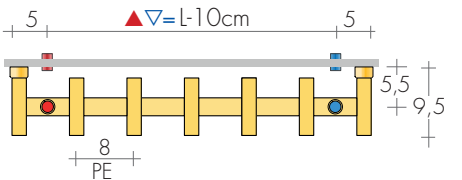

REGULAR 200/80-5el

RECOMMENDED VALVES

- CHROME VALVES KIT with:
- n°2 Valves with tailpieces
 - n°2 Fittings (multilayer ø16, copper ø12, 14)
 - n°2 Chrome wall plates ø 48, hole ø16

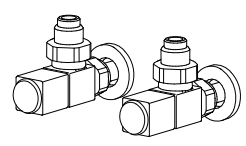

ANGLED QUADRA VALVES KIT
page 271 Art. KQS 180,10€
Extra for BREM color list 53,40€

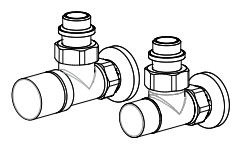

ANGLED CYL VALVES KIT with THERMOSTATIC
option, page.273 Art. KCS 149,90€
Extra for BREM color list 53,40€

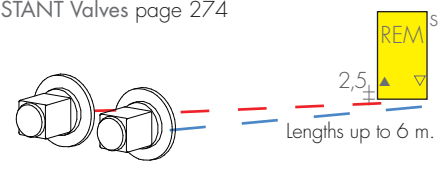

SPECIAL FINISHES page 267
Finishes Gold, Bronze, Brushed Nickel for 2 valves
Brushed Nickel FITTING KIT extra Art. RN 30,50€

REMOTE FITTINGS Art. REM 42,10€
Tapping centres: at the rear of radiator ▲ ▽ EG
DISTANT Valves page 274

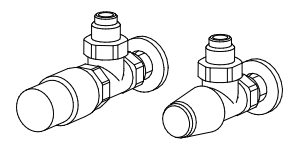

ANGLED TON VALVES KIT with THERMOSTATIC
Head, page 269 Art. KTS 190,30€

SBARRA SBARRA-UP

design Luigi Brembilla

The SBARRA and SBARRA-Up models are ideal where the needs of the available space

require exploiting every centimeter. With their minimalist design they can be used in

any environment, camouflaging themselves or, with colour, being protagonists.

DIMENSIONS

Width: 120/160 cm
Height: 8 / 18 / 28 cm
Depth: 5,8 cm
Depth from wall 9/11,5 cm

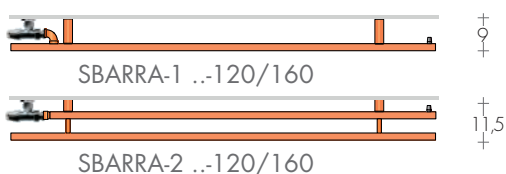
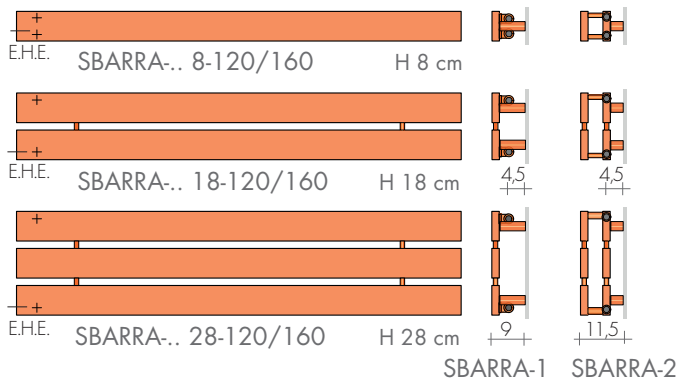

DIMENSIONS

Width: 8 / 18 / 28 cm
Height: 180 / 200 / 220 cm
Depth: 5,8/8 cm
Depth from wall: 9/11,5 cm

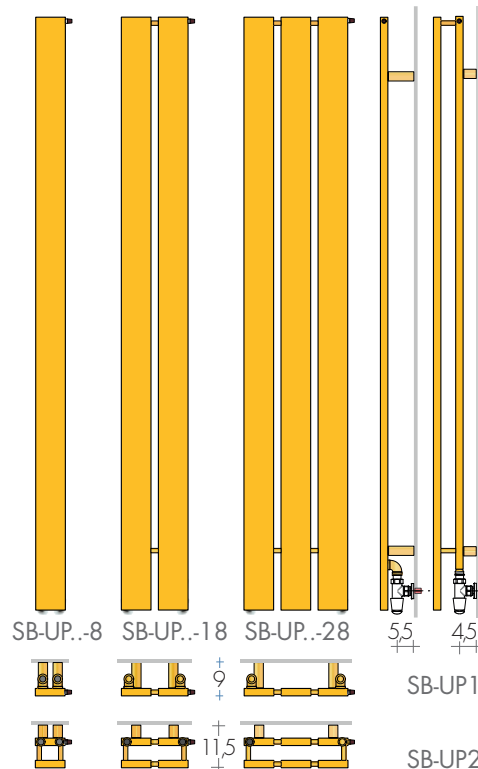

EN 442 Watt Δt 50K (Δt 40K = $W \times 0,755$) (Δt 30K = $W \times 0,526$)

MODEL	HL cm	Standard white sablé SB 9016 €	EN 442 Δt 50K watt	▲▼ t.c. cm	DUAL FUEL VERSION with E.H.E. and sleeve	
					Watt	€
SBARRA-1	8-120	401,10	138	4,5	-	-
SBARRA-1	8-160	451,60	184	4,5	-	-
SBARRA-1	18-120	508,30	265	14	250	125,10
SBARRA-1	18-160	568,20	353	14	400	127,40
SBARRA-1	28-120	615,80	380	24	400	127,40
SBARRA-1	28-160	684,40	507	24	500	129,60
SBARRA-2	8-120	790,70	226	4,5	250	125,10
SBARRA-2	8-160	873,90	301	4,5	300	126,20
SBARRA-2	18-120	994,30	434	14	500	129,60
SBARRA-2	18-160	1094,70	578	14	650	131,80
SBARRA-2	28-120	1198,50	623	24	650	131,80
SBARRA-2	28-160	1316,10	831	24	800	136,60

Prices and thermal yields of lengths intermediate, for interpolation. Thermostats p.208-209
L 180, 200 and 220, values as SB-UP.

MODEL	L H cm	L cm		
		8	18	28
SB-UP1 180	€	468,90	585,20	701,70
		197w	378w	543w
SB-UP2 180	€	891,30	1112,00	1333,20
		323w	619w	884w
SB-UP1 200	€	487,50	604,00	720,30
		219w	420w	603w
SB-UP2 200	€	909,80	1130,80	1351,70
		359w	688w	982w
SB-UP1 220	€	506,00	622,40	738,80
		240w	462w	664w
SB-UP2 220	€	928,40	1149,30	1370,30
		394w	757w	1081w

On request models with Heights from 160 to 300 cm

DUAL FUEL VERSION

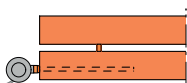

KNOBS p. 277

DUAL FUEL VERSION

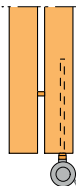

Dual fuel version models on request

SB-UP1 180-18 400W	SB-UP1 220-8 250W
SB-UP1 180-28 500W	SB-UP1 220-18 500W
SB-UP2 180-8 300W	SB-UP1 220-28 650W
SB-UP2 180-18 650W	SB-UP2 220-8 400W
SB-UP2 180-28 900W	SB-UP2 220-18 800W
SB-UP1 200-18 400W	
SB-UP1 200-28 650W	

STANDARD PRODUCTION

White "sablé" SB9016 paintwork
Tolerance ± 3 mm - Air vent $\varnothing 1/8"$
MAXIMUM OPERATING PRESSURE 4 BAR

PRODUCTION ON REQUEST

Paintwork to Brem color list with colored brackets
+1,5/25%
Electric version e.Sbarra, page 256

STANDARD FITTING

Horizontal models AC $\varnothing 1/2"$
Vertical models REG $\varnothing 1/2"$
brackets B 35mm p=5,5 (SB-UP1)

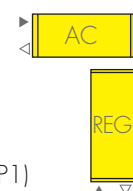

TAPPING CENTRES

MOD. SBARRA

SBARRA.. 8..

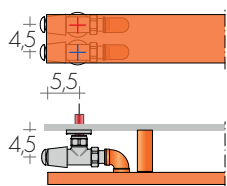

SBARRA.. 18..

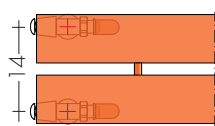

SBARRA.. 28..

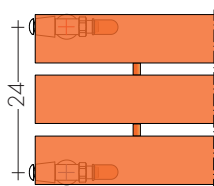

RECOMMENDED VALVES

VALVES KIT WITH:

- n°2 Valves with chrome tailpieces
- n°2 Fittings (multilayer ø16, copper ø12, 14)
- n°2 Chrome wall plates ø 48, hole ø16

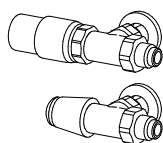
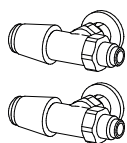

REVERSE TON VALVES KIT
page 269 Art. KVR 137,10€

REVERSE TON VALVES KIT with THERMO-
STATIC Head .p. 269 Art. KTR 190,30€

MOD. SBARRA-UP

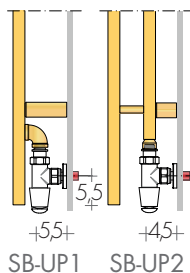
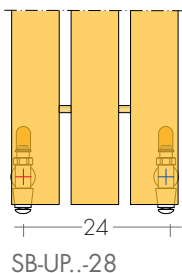
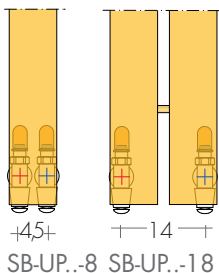

RECOMMENDED VALVES

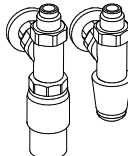
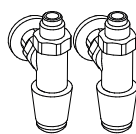

REVERSE TON VALVES KIT
page 269 Art. KVR 137,10€

REVERSE TON VALVES KIT with THERMO-
STATIC Head .p. 269 Art. KTR 190,30€

REMOTE FITTINGS Art. REM 42,10€

SBARRA: at the rear ▲▼ AC standard)

SBARRA -UP: at the rear ▲▼ REG

DISTANT VALVES page 274

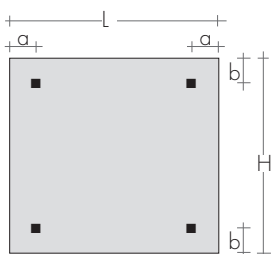

FIXINGS

Brackets included

SBARRA-1 e SB-UP1 Art. B70

SBARRA-2 e SB-UP2 Art. B35

Mod. a cm b cm

SBARRA.. H8 16 2

SBARRA.. H18 16 4

SBARRA.. H28 16 4

SB-UP ..-8 2 16

SB-UP ..-18 4 16

SB-UP ..-28 4 16



SBARRA-2 18-120



SB-UP1 180-8

TORRI

TORRI radiators are inspired by the jagged skyline of a modern metropolis. The challenge

was to design a tall, slim radiator that would act as an architectural feature in the dome-

stic environment. TORRI radiators are made from parallel, totally plain, steel plates. *design Bettazzi + Percoco*

DIMENSIONS

Height: 177/197/217/237 cm

Width: da 22 a 98 cm

Depth: 9,5 cm

Depth from wall: 11 cm

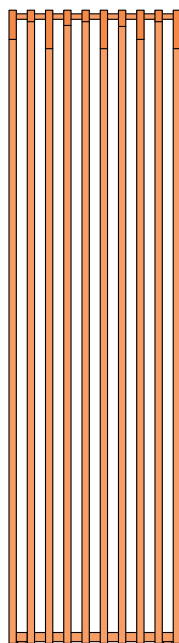

ELEMENT STEP 50 (PE50)
L = n° el. x 5 cm step - 3 cm

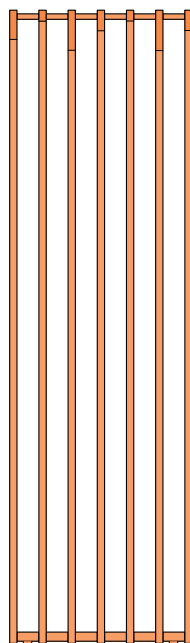

ELEMENT STEP 80 (PE80)
L = n° el. x step 8 cm - 6 cm

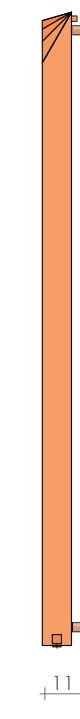

Mod. TO.../50

Mod. TO.../80

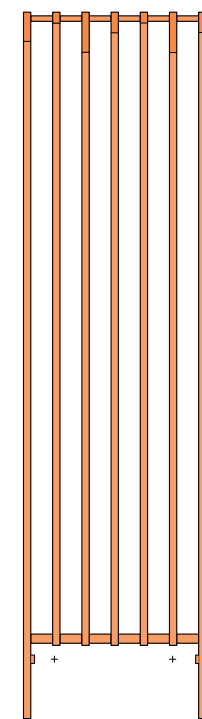

Mod. TOB...

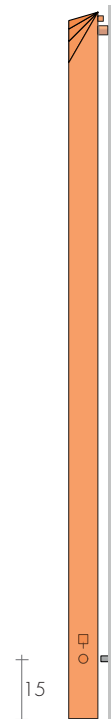

6,7

MOD.	n° el step mm	5 el		6 el		7 el		8 el		9 el		10 el		11 el		12 el		13 el		15 el
		/50	/80	/50	/80	/50	/80	/50	/80	/50	/80	/50	/80	/50	/80	/50	/80	/50	/80	/50
	H cm	22	34	27	42	32	50	37	58	42	66	47	74	52	82	57	90	62	98	72
	L cm	15	24	20	32	25	40	30	48	35	56	40	64	45	72	50	80	55	88	65
TO 180/..	€	940,20	1052,00	1163,90	1275,70	1387,60	1499,20	1611,10	1723,00	1834,80	2058,30									
177	w	675	798	810	957	945	1117	1080	1276	1215	1436	1350	1595	1485	1755	1620	1914	1755	2074	2025
TO 200/..	€	983,40	1100,00	1216,40	1333,10	1449,60	1566,20	1683,00	1799,50	1916,10	2149,30									
197	w	751	888	901	1065	1051	1243	1202	1420	1352	1598	1502	1775	1652	1953	1802	2130	1953	2308	2253
TO 220/..	€	1025,50	1146,80	1268,00	1389,20	1510,40	1631,70	1752,90	1874,20	1995,30	2237,80									
217	w	828	978	993	1173	1159	1369	1324	1564	1490	1760	1655	1955	1821	2151	1986	2346	2152	2542	2483
TO 240/..	€	1068,50	1194,60	1320,70	1446,50	1572,60	1698,60	1824,70	1950,70	2076,70	2328,70									
237	w	904	1068	1084	1282	1265	1495	1446	1709	1626	1922	1807	2136	1988	2350	2168	2563	2349	2777	2711

Intermediate heights, every 10 cm, by interpolatio
Made-to-measure heights on request.

EN 442 Watt Δt 50K (Δt 40K = $W \times 0,755$) (Δt 30K = $W \times 0,526$)
 Δt different from 50 K: consult technical data Brem

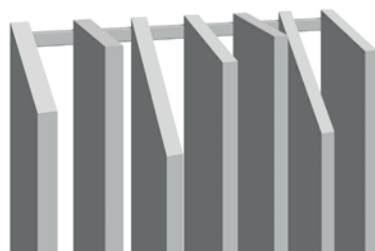

Right repetition of inclined elements every 7 elements

Es.: TO 220/80 - 9el EG \varnothing 1/2" SB3061

STANDARD PRODUCTION

White sablé SB9016 paintwork, brackets B27
Tolerance \pm 3mm - Air vent \varnothing 1/8"

MAXIMUM OPERATING PRESSURE 4 BAR

PRODUCTION ON REQUEST

Paintwork to Brem color list (colored brackets B27)

Made-to-measure, ask for feasibility

STANDARD FITTING

EG \varnothing 1/2"
On request fittings \varnothing 3/8"
Special fittings, page 278



TAPPING CENTRES
TORRI STEP 50 mm

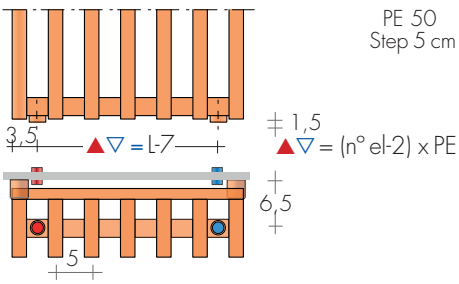

PE 50
Step 5 cm

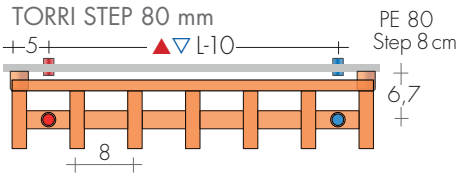

PE 80
Step 8 cm

TORRI with feet h=20 cm
Art. TOB extra 132,40€

Tapping centres REG with
reverse valves ▲▽ = L - 14 cm

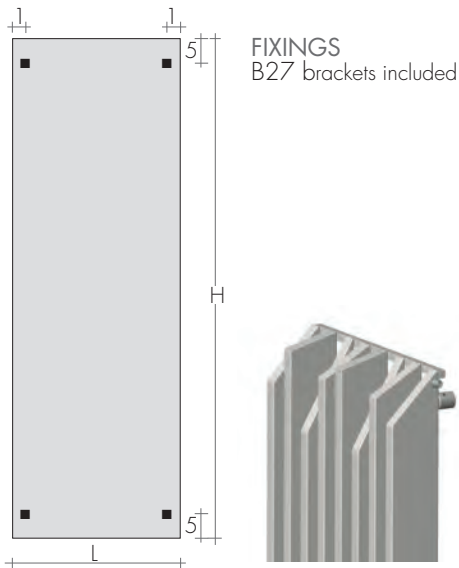
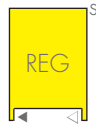

FIXINGS
B27 brackets included



TO 220 /50- 7el

RECOMMENDED VALVES

CHROME VALVES KIT with:

- n°2 Valves with tailpieces
- n°2 Fittings (multilayer ø16, copper ø12, 14)
- n°2 Chrome wall plates ø 48, hole ø16

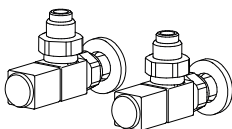

ANGLED QUADRA VALVES KIT
page 271 Art. KQS 180,10€
Extra for BREM color list 53,40€

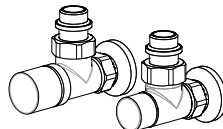

ANGLED CYL VALVES KIT with THERMOSTATIC
option, page.273 Art. KCS 149,90€
Extra for BREM color list 53,40€

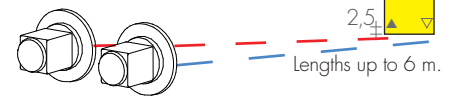

SPECIAL FINISHES page 267
Finishes Gold, Bronze, Brushed Nickel for 2 valves
Brushed Nickel FITTING KIT extra Art. RN 30,50€

REMOTE FITTINGS Art. REM 42,10€
Tapping centres: at the rear of radiator ▲▽ EG
DISTANT Valves page 274

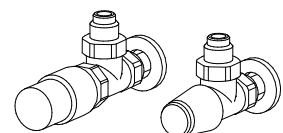

ANGLED TON VALVES KIT with THERMOSTATIC
Head, page 269 Art. KTS 190,30€

GUEST

design Davide Diliberto

GUEST towel holder replaces traditional towel holders accessories.

The simple shapes, almost bidimensional like graphic signs, make it ideal for small rooms

where space is precious. Electric freestanding version p. 232

DIMENSIONS

Width: 12/22/32 cm
 Height: 88/104/182/198 cm
 Depth: 40 cm
 Depth from wall: 41,5 cm

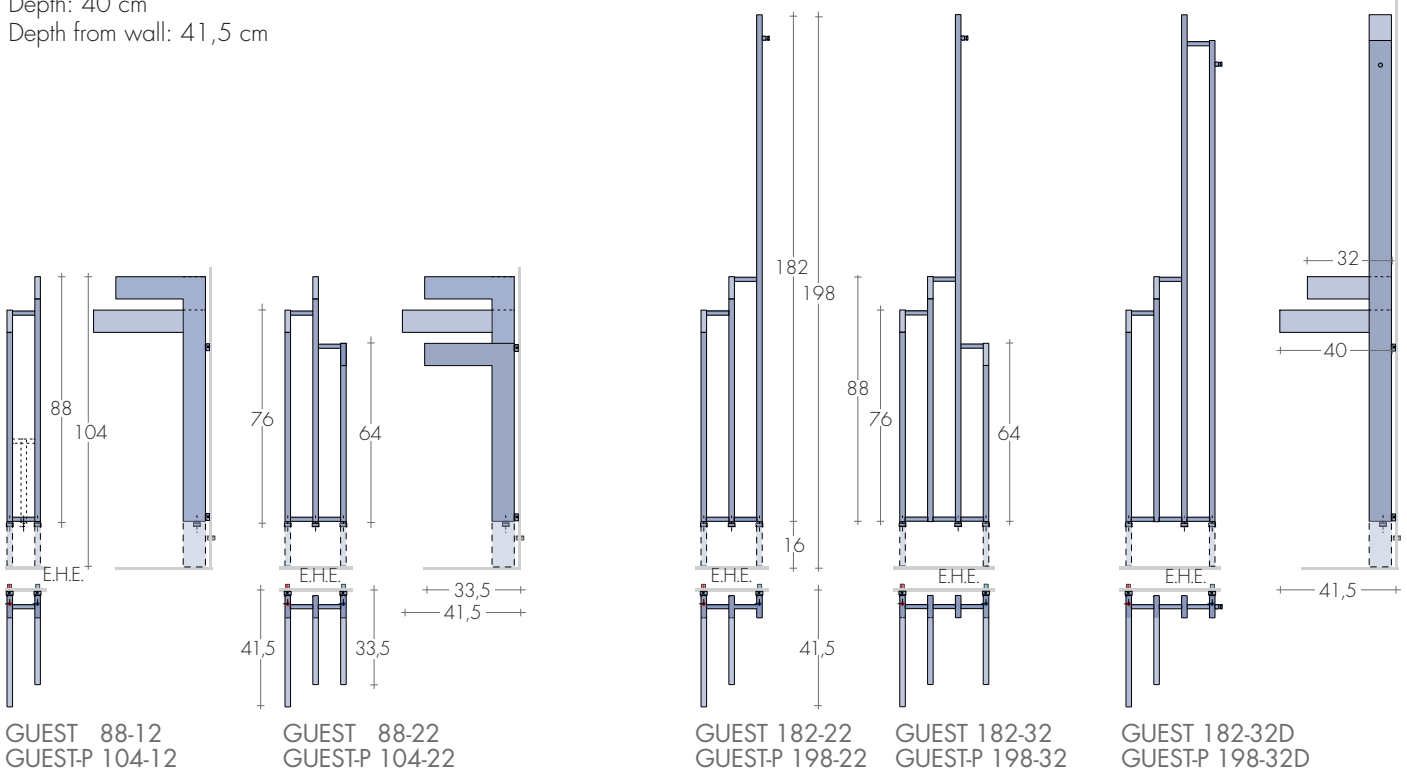

MODEL

MODEL	H/L cm	Standard white sablé SB 9016 €	EN 442			▲ ▼ i.c. cm	Hauteur H cm	Largeur L cm	Poids M Kg	Volume V dm ³	DUAL FUEL VERSION with E.H.E. and sleeve	
			Δt 50K watt	Δt 40K watt	Δt 30K watt						Watt	€
GUEST 88-12	88	391,70	269	199	134	10	88	12	4,7	2,9	*250	125,10
GUEST 88-22	88	526,40	379	280	189	20	88	22	6,6	4,1	400	127,40
GUEST 182-22	182	613,50	491	362	245	20	182	22	8,6	5,3	500	129,60
GUEST 182-32	182	695,00	602	444	300	30	182	32	10,5	6,5	650	131,80
GUEST 182-32D	182	753,40	700	517	349	30	182	32	12,2	7,6	650	131,80
Models with Feet												
GUEST-P 104-12	104	428,00	307	227	153	5	104	12	5,3	3,3	300	126,20
GUEST-P 104-22	104	562,70	417	308	208	9	104	22	7,2	4,5	400	127,40
GUEST-P 198-22	198	649,80	530	391	264	9	198	22	9,2	5,7	500	129,60
GUEST-P 198-32	198	731,20	640	472	319	19	198	32	11,1	6,9	650	131,80
GUEST-P 198-32D	198	789,70	738	545	368	19	198	32	12,8	8,0	800	136,60

Models made in the right-turned version, without supplement.

*Only resistance with cable
Thermostats p.208-209

STANDARD PRODUCTION

White "sablé" SB9016 paintwork, brackets B15
 Tolerance ± 3mm - Air vent ø 1/8"
 MAXIMUM OPERATING PRESSURE 4 BAR

PRODUCTION ON REQUEST

Paintwork to Brem color list (colored brackets B15) +15/25%
 Electric version e.GUEST, p.232

STANDARD FITTING

EG, REG ø 1/2"
 On request fittings ø 3/8"
 Special fittings, page 279

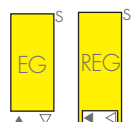

TAPPING CENTRES

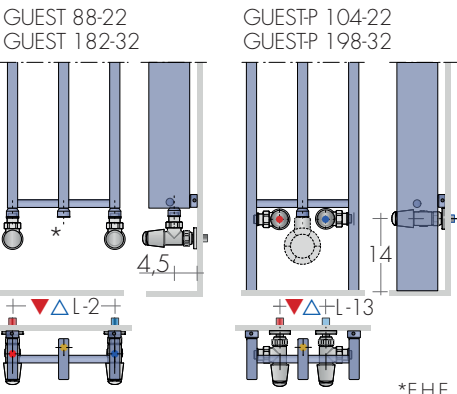
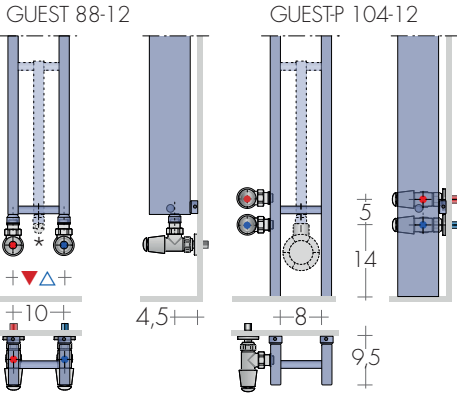

*E.H.E.
Electric Heating Element

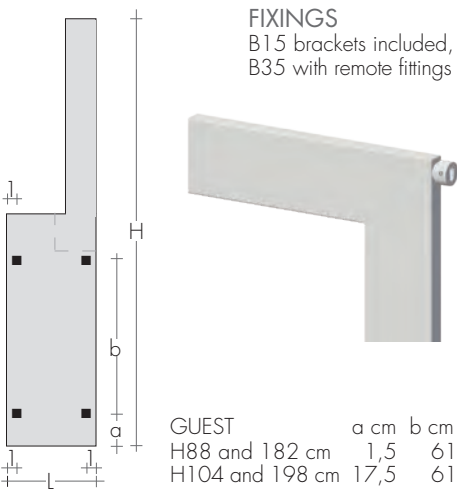

FIXINGS
B15 brackets included,
B35 with remote fittings



GUEST 182-22

RECOMMENDED VALVES

- CHROME VALVES KIT with:
- n°2 Valves with tailpieces
 - n°2 Fittings (multilayer ø16, copper ø12, 14)
 - n°2 Chrome wall plates ø 48, hole ø16

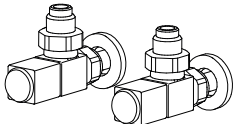

ANGLED QUADRA VALVES KIT
page 271 Art. KQS 180,10€
Extra for BREM color list 53,40€

SPECIAL FINISHES page 267
Finishes Gold, Bronze, Brushed Nickel for 2 valves
Brushed Nickel FITTING KIT extra Art. RN 30,50€

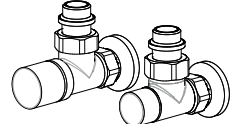

ANGLED CYL VALVES KIT with THERMOSTATIC option, page.273 Art. KCS 149,90€
Extra for BREM color list 53,40€

REMOTE FITTINGS Art. REM 42,10€
Tapping centres: at the rear of radiator ▲▼ EG
DISTANT Valves page 274

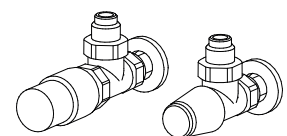
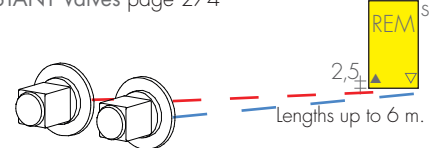

ANGLED TON VALVES KIT with THERMOSTATIC Head, page 269 Art. KTS 190,30€

HERG-ÖT

design Luigi Brembilla

Herg-ÖT recalls the iconic shape of the ladder and can be placed perpendicular

or slightly inclined. The parallel tubes give comfort and warmth to the bathroom and

work as a support for clothing, bathrobes and towels.

DIMENSIONS

Width: 42 / 50 / 58 cm
 Height: 184,7 / 212,4 cm
 Depth: 12 cm
 Depth from wall: 12 cm

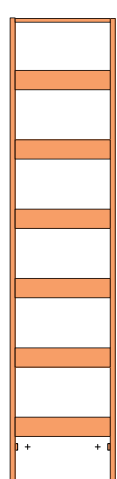
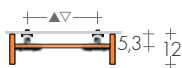

HERG-ÖT 185-..

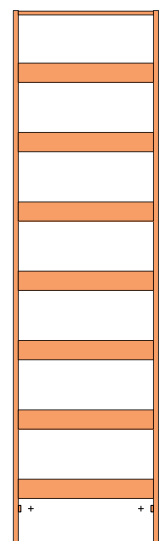
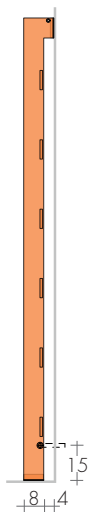

HERG-ÖT 212-..

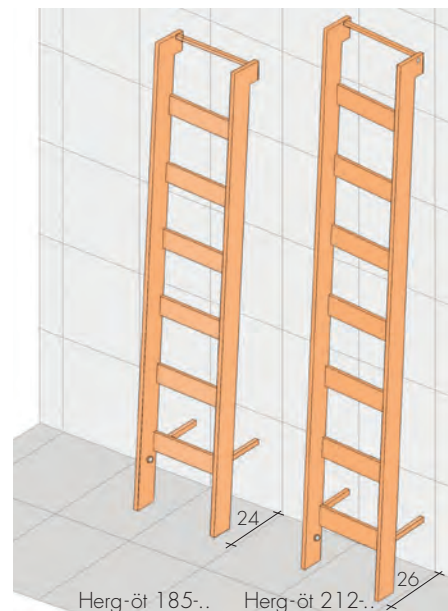
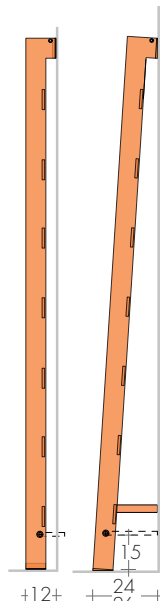

On request: Inclined version Art. HOI

MODEL	H/L cm	Standard white sablé SB 9016 €	EN 442			▲ ▽ t.c. cm	Height H (H _i) cm	Width L cm	Weight M Kg	Volume V dm ³	DUAL FUEL VERSION with E.H.E. and sleeve	
			Δt 50 K watt	Δt 40 K watt	Δt 30 K watt						Watt	€
HERG-ÖT	185-42	995,20	625	472	329	27	184	42	11,5	6,0	650	131,80
HERG-ÖT	185-50	1017,30	669	505	352	35	184	50	12,3	6,3	650	131,80
HERG-ÖT	185-58	1053,40	713	538	375	43	184	58	13,0	6,5	650	131,80
HERG-ÖT	212-42	1138,80	735	555	387	27	216	42	13,5	7,1	800	136,60
HERG-ÖT	212-50	1163,20	787	594	414	35	216	50	14,4	7,3	800	136,60
HERG-ÖT	212-58	1204,20	840	634	442	43	216	58	15,3	7,6	900	140,20

On request, HERG-ÖT INCLINED Art. HOI supplement 108,80€

Thermostats p.208-209

STANDARD PRODUCTION

White "sablé" paintwork SB9016
 Tolerance ± 3mm - Air vent ø 1/8"
 MAXIMUM OPERATING PRESSURE 4 BAR

PRODUCTION ON REQUEST

Paintwork to Brem color list
 (with colored brackets) +15/25%
 Electric version e.Herg-öt, p.234

STANDARD FITTING

REG ø 1/2"
 On request fittings ø3/8"
 Special fittings, page 279



TAPPING CENTRES

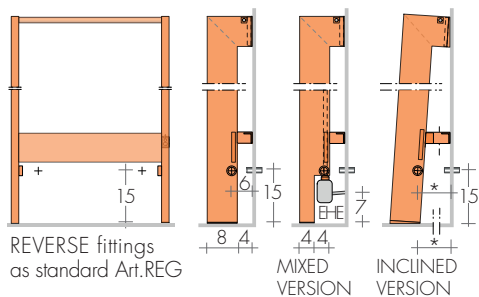

On request
ANGLED HERGÖT Herg-öt H 185:*17,5 cm
 Art. HOI 108,80€ Herg-öt H 212:*19,5 cm

E.H.E.
 Electric Heating
 Element

REMOTE FITTINGS

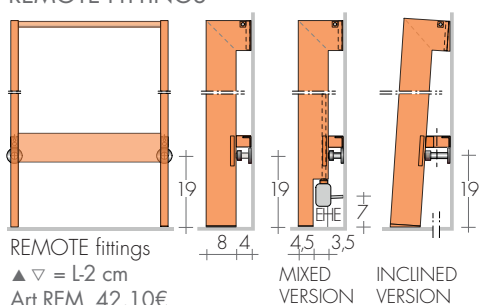

REMOTE fittings
 ▲ ▽ = L-2 cm
 Art REM 42,10€

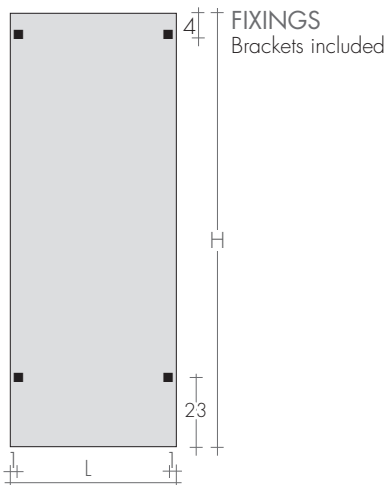

HERG-ÖT 212-42

RECOMMENDED VALVES

CHROME VALVES KIT with:
 - n°2 Valves with tailpieces
 - n°2 Fittings (multilayer ø16, copper ø12, 14)
 - n°2 Chrome wall plates ø 48, hole ø16

SPECIAL FINISHES page 267
 Finishes Gold, Bronze, Brushed Nickel for 2 valves
 Brushed Nickel FITTING KIT extra Art. RN 30,50€

REMOTE FITTINGS Art. REM 42,10€
 Tapping centres: at the rear of radiator ▲ ▽ L-2cm
 DISTANT Valves page 274

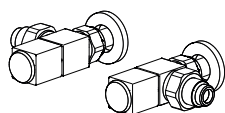
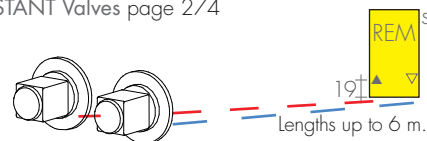

ANGLED QUADRA VALVES KIT
 page 271 Art. KQS 180,10€
 Extra for BREM color list 53,40€

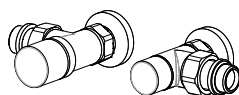

ANGLED CYL VALVES KIT with THERMOSTATIC
 option, page.273 Art. KCS 149,90€
 Extra for BREM color list 53,40€

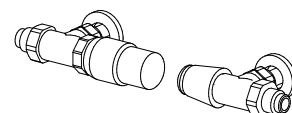

ANGLED TON VALVES KIT with THERMOSTATIC
 Head, page 269 Art. KTS 190,30€

HERG'S

design Luigi Brembilla

HERG's is a new towel rails that recalls the simple heated towel rails.

The protagonist is the large rectangular tube arranged in regular rhythms that gives

heat performance for the complete comfort of the bathroom.

DIMENSIONS

Width: 42 / 50 / 58 cm

Height: 64,4 / 92,1 / 119,8 / 147,5 / 175,2 / 202,9 cm

Depth: 12 cm

Depth from wall: 12 cm

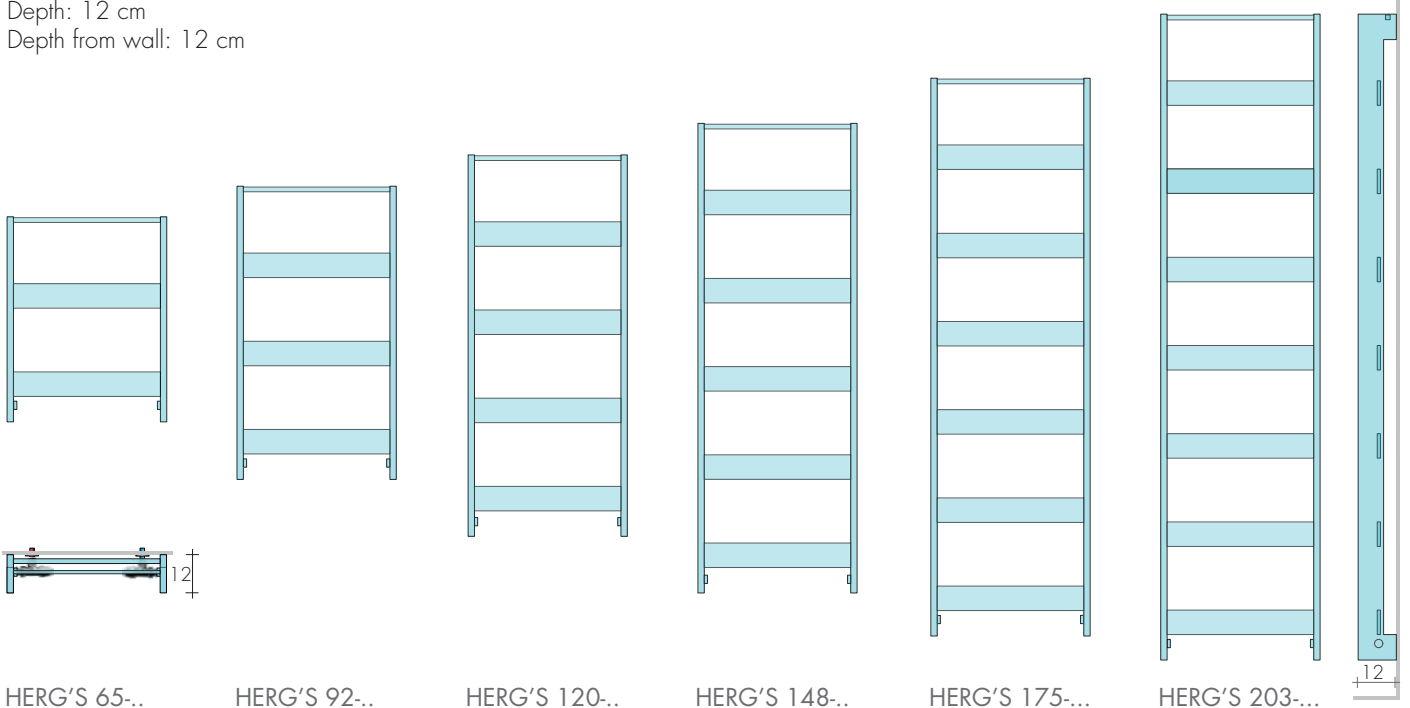

HERG'S 65-..

HERG'S 92-..

HERG'S 120-..

HERG'S 148-..

HERG'S 175-...

HERG'S 203-...

MODEL	H/L cm	Standard white sablé SB 9016 €	EN 442			▲ ▽ t.c. cm	Height H (H1) cm	Width L cm	Weight M Kg	Volume V dm ³	DUAL FUEL VERSION with E.H.E. and sleeve €	
			Δt 50 K watt	Δt 40 K watt	Δt 30 K watt						Watt	€
HERG'S	65-42	533,80	249	188	131	27	64,4	42	4,6	2,4	250	125,10
HERG'S	65-50	569,20	268	202	141	35	64,4	50	4,9	2,5	300	126,20
HERG'S	92-42	642,40	350	264	184	27	92,1	42	6,4	3,3	400	127,40
HERG'S	92-50	677,80	378	285	199	35	92,1	50	6,9	3,4	400	127,40
HERG'S	120-42	751,00	452	341	238	27	119,8	42	8,3	4,2	400	127,40
HERG'S	120-50	786,40	487	368	256	35	119,8	50	8,9	4,4	500	129,60
HERG'S	148-42	859,50	553	418	291	27	147,5	42	10,1	5,2	500	129,60
HERG'S	148-50	895,10	597	451	314	35	147,5	50	10,9	5,4	650	131,80
HERG'S	148-58	922,70	641	484	337	43	147,5	58	11,6	5,6	650	131,80
HERG'S	175-42	968,20	652	492	343	27	175,2	42	12	6,1	650	131,80
HERG'S	175-50	1003,60	705	532	371	35	175,2	50	12,9	6,4	650	131,80
HERG'S	175-58	1031,40	757	572	398	43	175,2	58	13,7	6,6	800	136,60
HERG'S	203-50	1066,80	813	614	428	35	202,9	50	14,9	7,3	800	136,60
HERG'S	203-58	1094,50	873	659	459	43	202,9	58	15,9	7,7	900	140,20

Available in Stock

Thermostats p.208-209

STANDARD PRODUCTION

White "sablé" paintwork SB9016

Tolerance ± 3mm - Air vent ø 1/8"

MAXIMUM OPERATING PRESSURE 4 BAR

PRODUCTION ON REQUEST

Paintwork to Brem color list
Electric version e.Herg's, p.235

+1,5/25%

STANDARD FITTING

REG ø 1/2"

On request fittings ø3/8"

Special fittings, page 279

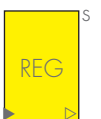

TAPPING CENTRES

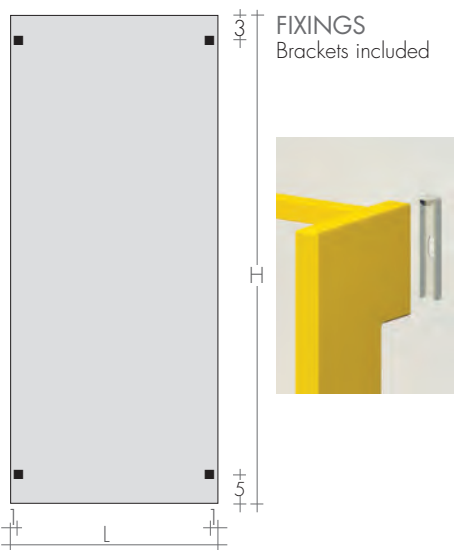
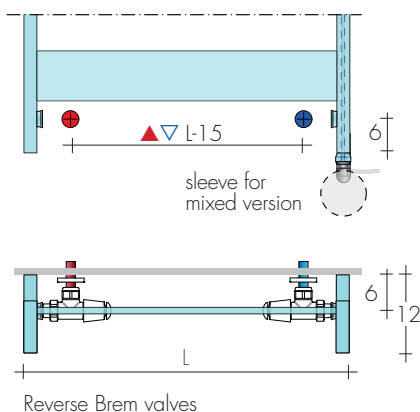

HERG'S 92.50

RECOMMENDED VALVES

- CHROME VALVES KIT with:
- n°2 Valves with tailpieces
 - n°2 Fittings (multilayer ø16, copper ø12, 14)
 - n°2 Chrome wall plates ø 48, hole ø16

SPECIAL FINISHES page 267
 Finishes Gold, Bronze, Brushed Nickel for 2 valves
 Brushed Nickel FITTING KIT extra Art. RN 30,50€

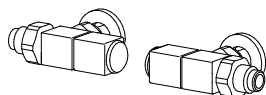

REVERSE VALVES QUADRA KIT
 page 271 Art. KQR 180,10€
 Extra for BREM color list 53,40€

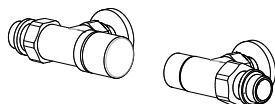

REVERSE VALVES CYL KIT with THERMOSTATIC
 option, page 273 Art. KCR 149,90€
 Extra for BREM color list 53,40€

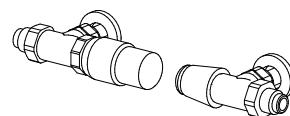

REVERSE VALVES TON KIT with THERMOSTATIC
 Head, page 269 Art. KTR 190,30€

HOOK

design Luigi Brembilla

In narrow rooms where every cm is important, HOOK perfectly fits the place;

it also gives you the opportunity to hang and to heat the clothes and the bathrobes.

HOOK can be used anywhere in the house and it can also heat the bathroom.

LAME

DIMENSIONS

Width: 9 / 19 / 29 cm
 Height: 180 / 210 cm
 Depth: 5,5/9 cm
 Depth from wall: 9,5/13 cm



KNOB mod.HK, standard included and welded to radiator:

STANDARD COLORS

- white sablé SB 9016
- quartz grey SB 7039
- jet black SB 9005
- same color of radiator

- in one color of Brem color list different from the radiator extra 52,90€

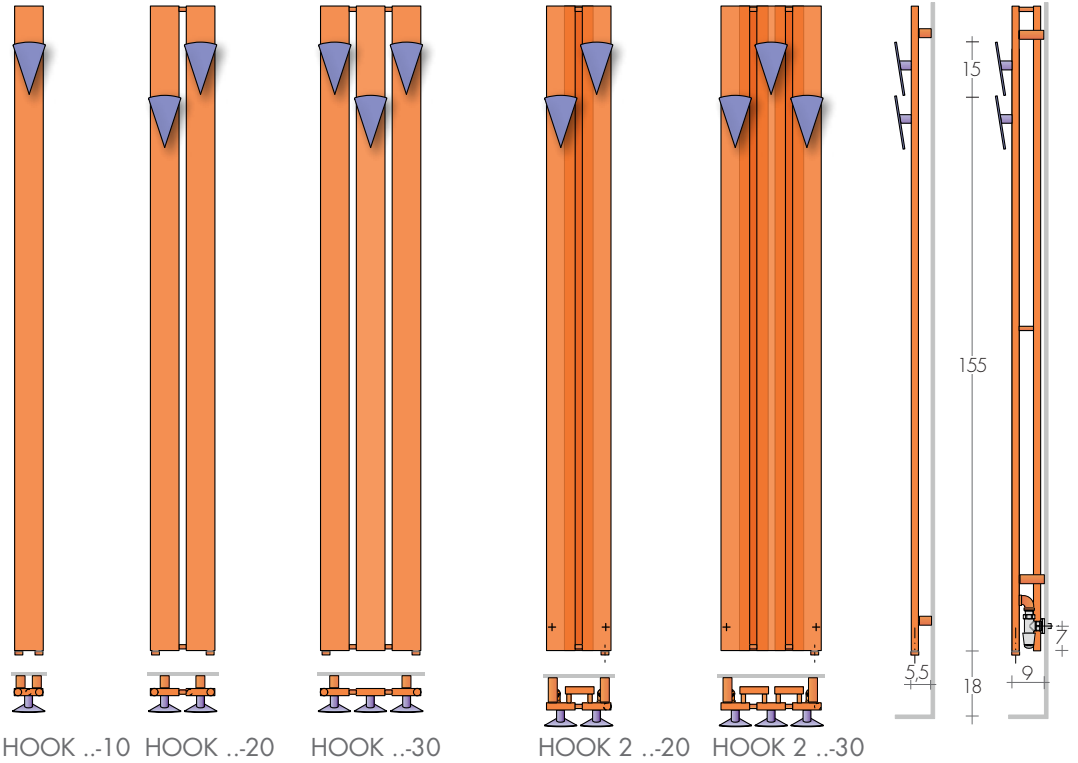

MODEL	HL cm	Standard white sablé SB 9016 €	EN 442			▲ ▽ t.c. cm	Height H cm	Width L cm	Depth p cm	Weight M Kg	Volume V dm³	DUAL FUEL VERSION with E.H.E. and sleeve	
			Δt 50 K watt	Δt 40 K watt	Δt 30 K watt							Watt	€
HOOK	180-10	562,40	197	148	102	5	180	9	6	4,1	2,4	250	125,10
HOOK	180-20	771,80	378	284	197	15	180	19	6	8,2	4,7	400	127,40
HOOK	180-30	981,70	543	408	282	25	180	29	6	12,3	7,1	500	129,60
HOOK	210-10	580,80	230	173	120	5	210	9	6	4,8	2,7	250	125,10
HOOK	210-20	790,60	441	331	229	15	210	19	6	9,5	5,5	400	127,40
HOOK	210-30	1000,20	632	475	329	25	210	29	6	14,3	8,2	650	131,80
HOOK-2	180-20	971,80	511	384	266	15	180	19	10	12,3	7,1	500	129,60
HOOK-2	180-30	996,80	650	447	338	25	180	29	10	20,4	11,8	650	131,80
HOOK-2	210-20	1156,50	595	488	309	15	210	19	10	14,3	8,2	650	131,80
HOOK-2	210-30	1181,20	850	638	442	25	210	29	10	23,8	13,7	900	129,00

Available in Stock

Mod. HOOK..-10 only with left mixed valve p.207
 Thermostats p.208-209

KNOB, on demand without extra



KNOB model PO



KNOB model ARO

STANDARD PRODUCTION

White "sablé" SB9016 paintwork
 Tolerance ± 3mm - Air vent ø 1/8"
 MAXIMUM OPERATING PRESSURE 4 BAR

PRODUCTION ON REQUEST

Paintwork to Brem color list +15/25%
 Knobs fixing at different heights without extra
 Electric version e.Hook, page 236

STANDARD FITTING

EG ø 1/2"
 On request fittings ø3/8"
 Special fittings, page 279



TAPPING CENTRES

HOOK ...-10

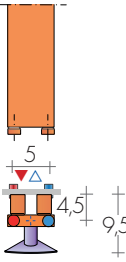

HOOK ...-20 - HOOK ...-30

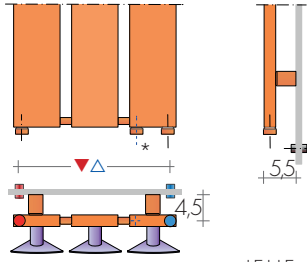

*E.H.E.
Electric Heating
Element

HOOK 2...-20 - HOOK 2...-30

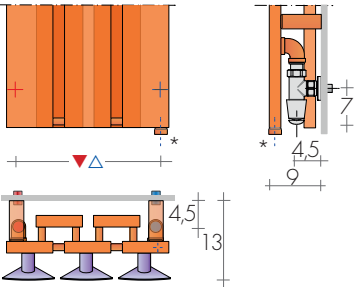

Fittings at the rear with reverse valves

VALVES for fittings at the rear
Mod. HOOK2..

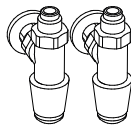

REVERSE TON VALVES KIT

page 269

Art. KVR 137,10€

REVERSE TON VALVES KIT with
THERMOSTATIC head

Art. KTR 190,30€

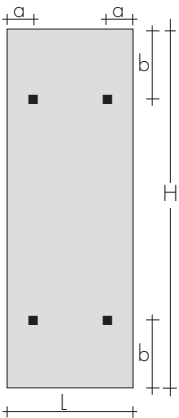

FIXINGS

Brackets included
HOOK Art. B35
HOOK-2 Art. B70

Model	a cm	b cm
HOOK ...-10	1,8	4
HOOK ...-20	4	4
HOOK ...-30	4	4
HOOK2...-20	2,2	20
HOOK2...-30	2,2	20



HOOK 180-20

RECOMMENDED VALVES

CHROME VALVES KIT with:

- n°2 Valves with tailpieces
- n°2 Fittings (multilayer ø16, copper ø12, 14)
- n°2 Chrome wall plates ø 48, hole ø16

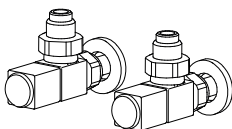

ANGLED QUADRA VALVES KIT

page 271

Art. KQS

180,10€

Extra for BREM color list

53,40€

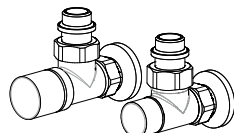

ANGLED CYL VALVES KIT with THERMOSTATIC

option, page.273

Art. KCS 149,90€

Extra for BREM color list

53,40€

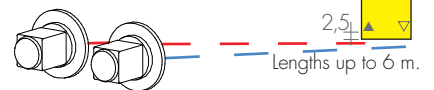

SPECIAL FINISHES

page 267

Finishes Gold, Bronze, Brushed Nickel for 2 valves

Brushed Nickel FITTING KIT extra Art. RN 30,50€

REMOTE FITTINGS

Art. REM

42,10€

Tapping centres: at the rear of radiator ▲▽ EG

DISTANT Valves page 274

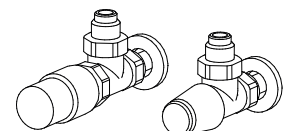

ANGLED TON VALVES KIT with THERMOSTATIC

Head, page 269

Art. KTS 190,30€

KUO is an original take on Japanese formalism and essential lines.

Its pure form is the result of using a flat plate with vertical elements laid down its

design Davide Brembilla
sides to limit the space and give a sense of slimness and vertical continuity.

DIMENSIONS

Width: 25/35/49 cm
Height: 110/140/180 cm
Depth: 8 cm
Depth from wall: 12 cm

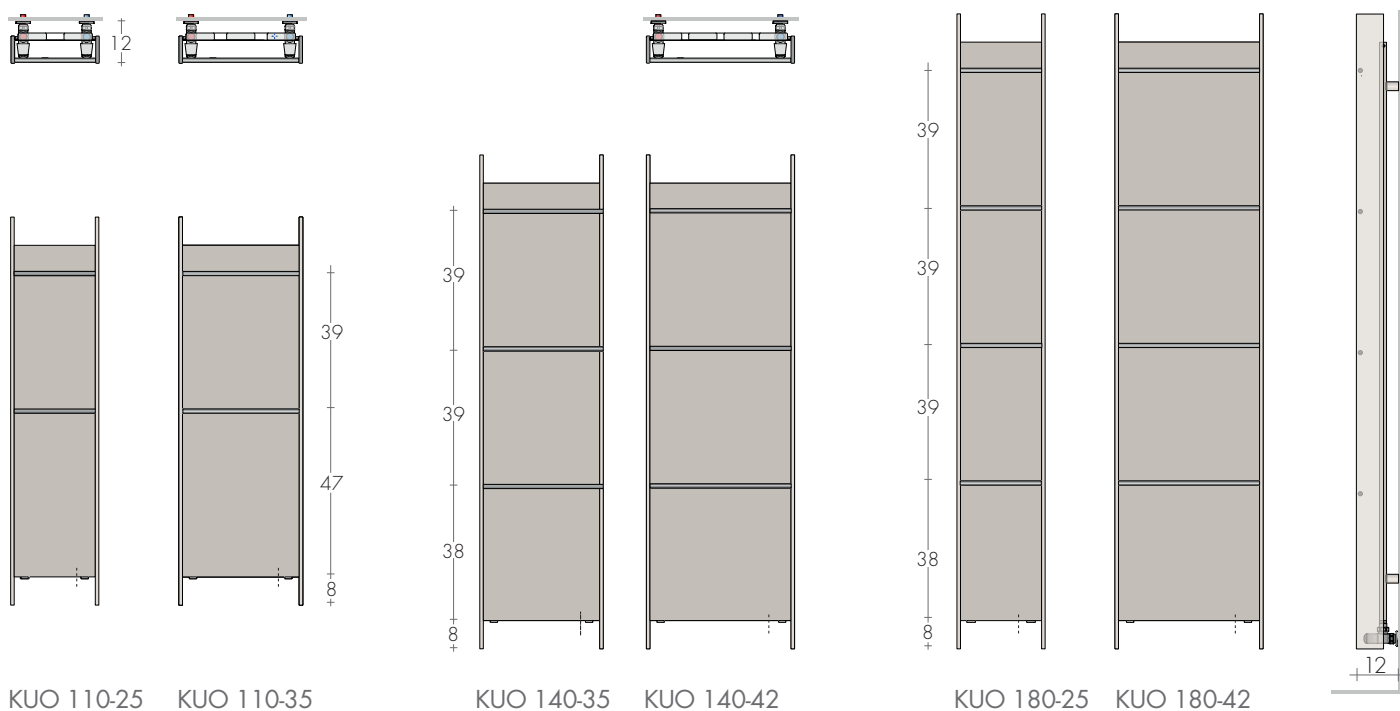

MODEL '25

	HL cm	Standard white sablé SB 9016 €	Δt 50 K watt	EN 442 Δt 40 K watt	Δt 30 K watt	▲▼ t.c. cm	Height H cm	Width L cm	Weight M Kg	Volume V dm ³	DUAL FUEL VERSION with E.H.E. and sleeve Watt €	
KUO	110-25	591,00	409	310	216	18	110	25	8,2	3,8	400	127,40
KUO	110-35	664,70	529	401	279	28	110	35	10,1	4,5	500	129,60
KUO	140-25	676,30	527	399	278	18	140	25	10,6	5,0	500	129,60
KUO	140-35	775,30	678	513	357	28	140	35	13,1	5,8	650	131,80
KUO	140-42	918,30	823	623	434	35	140	42	16,4	8,6	800	136,60
KUO	180-25	845,80	684	518	361	18	180	25	13,8	6,4	650	131,80
KUO	180-35	1013,40	877	664	462	28	180	35	17,0	7,5	900	140,20
KUO	180-42	1054,30	1064	806	561	35	180	42	21,2	11,1	1200	148,50

► Available in Stock

Thermostats p.208-209

STANDARD PRODUCTION

White sablé SB9016 paintwork - brackets B35
Tolerance ± 3mm - Air vent ø 1/8"
MAXIMUM OPERATING PRESSURE 4 BAR

PRODUCTION ON REQUEST

Paintwork to Brem color list with colored brackets B35 +15/25%
Electric version e.Kuo, p.239

STANDARD FITTING

EG ø 1/2"
On request fittings ø3/8"
Special fittings, p. 279



TAPPING CENTRES

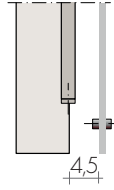
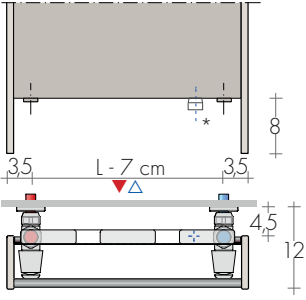

MIXED VERSIONS

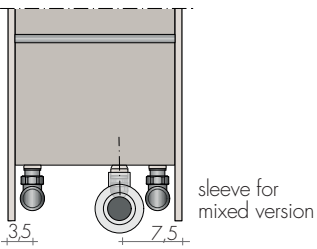

*E.H.E.
Electric Heating
Element

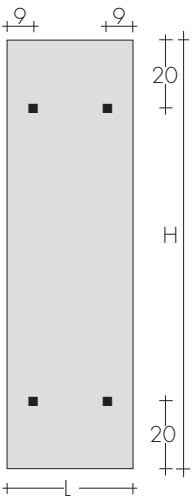

FIXINGS
B35 Brackets included



KUO 180-25

RECOMMENDED VALVES

CHROME VALVES KIT with:

- n°2 Valves with tailpieces
- n°2 Fittings (multilayer ø16, copper ø12, 14)
- n°2 Chrome wall plates ø 48, hole ø16

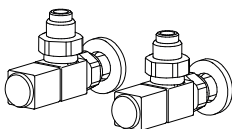

ANGLED QUADRA VALVES KIT
page 271 Art. KQS 180,10€
Extra for BREM color list 53,40€

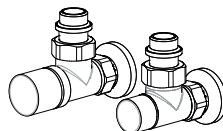

ANGLED CYL VALVES KIT with THERMOSTATIC
option, page.273 Art. KCS 149,90€
Extra for BREM color list 53,40€

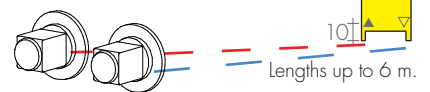

SPECIAL FINISHES page 267
Finishes Gold, Bronze, Brushed Nickel for 2 valves
Brushed Nickel FITTING KIT extra Art. RN 30,50€

REMOTE FITTINGS Art. REM 42,10€
Tapping centres: at the rear of radiator ▲▽ EG
DISTANT Valves page 274

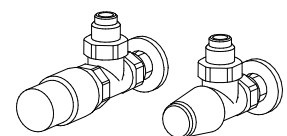

ANGLED TON VALVES KIT with THERMOSTATIC
Head, page 269 Art. KTS 190,30€

LAMATH

design Davide Brembilla

Straight, compact, and high thickness fins that cut the uniformity of the wall express a

new concept for heated towel rails that enliven and furnish bathroom walls.

The unusual and absolutely unexpected shape is as surprising as good sculpture can be.

DIMENSIONS

Width: 43,0 / 49,5 cm

Height: 190 / 210 cm

Depth: 8 cm

Depth from wall: 9,5 cm

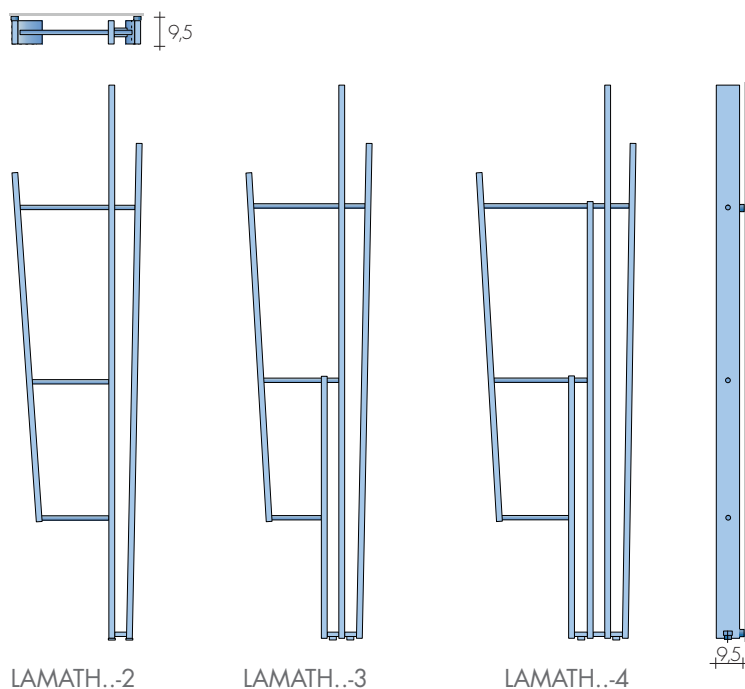

MODEL	H/L cm	Standard white sablé SB 9016 €	EN 442			▲ ▼ t.c. cm	Height H (H ₁) cm	Width L cm	Weight M Kg	Volume V dm ³	DUAL FUEL VERSION with E.H.E. and sleeve	
			Δt 50 K watt	Δt 40 K watt	Δt 30 K watt						Watt	€
LAMATH	190-2	723,40	467	345	243	6	190	43	14,4	6,3	400	127,40
LAMATH	190-3	857,40	555	410	289	6	190	43	17,2	7,5	500	129,60
LAMATH	190-4	991,90	700	517	364	12	190	49,5	21,7	9,4	650	131,80
LAMATH	210-2	774,60	525	387	273	6	210	43	16,3	7,1	500	129,60
LAMATH	210-3	927,10	642	474	334	6	210	43	19,9	8,6	650	131,80
LAMATH	210-4	1079,60	807	596	420	12	210	49,5	25,0	10,9	800	136,60

Available in Stock

Thermostats p.208-209

STANDARD PRODUCTION

White sablé SB9016 paintwork - Brackets B15
Tolerance ± 3mm - Air vent ø 1/8"

MAXIMUM OPERATING PRESSURE 4 BAR

PRODUCTION ON REQUEST

Paintwork to Brem color list (with colored brackets B15)

Electric version e.Lamath, page 240

STANDARD FITTING

EG ø 1/2"

On request fittings ø 3/8"

Special fittings, page 279



TAPPING CENTRES

LAMATH...2



LAMATH...3

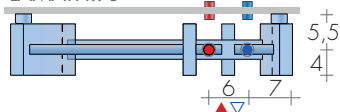

LAMATH...4

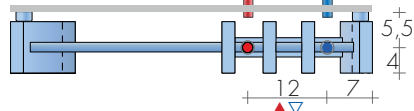

MIXED VERSIONS*

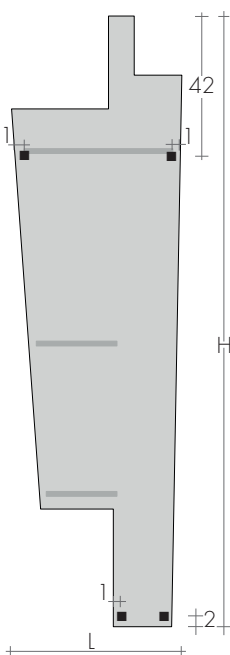
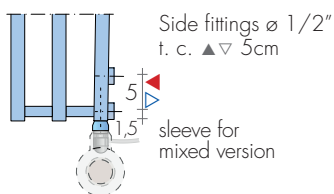

FIXINGS

B15 brackets included,
B27 with remote fittings
and B35 Lame ...2



LAMATH 190-3

RECOMMENDED VALVES

CHROME VALVES KIT with:

- n°2 Valves with tailpieces
- n°2 Fittings (multilayer \varnothing 16, copper \varnothing 12, 14)
- n°2 Chrome wall plates \varnothing 48, hole \varnothing 16

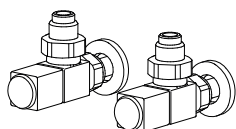

ANGLED QUADRA VALVES KIT
page 271 Art. KQS
Extra for BREM color list

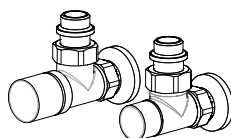

ANGLED CYL VALVES KIT with THERMOSTATIC
option, page.273 Art. KCS 149,90€
Extra for BREM color list 53,40€

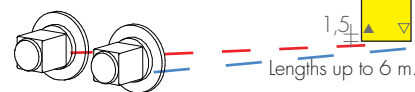

SPECIAL FINISHES page 267
Finishes Gold, Bronze, Brushed Nickel for 2 valves
Brushed Nickel FITTING KIT extra Art. RN 30,50€

REMOTE FITTINGS Art. REM 42,10€
Tapping centres: at the rear of radiator \blacktriangle \blacktriangledown EG
DISTANT Valves page 274

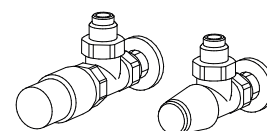

ANGLED TON VALVES KIT with THERMOSTATIC
Head, page 269 Art. KTS 190,30€

LAME SLIM

design Davide Brembilla

Straight, compact and high thickness fins that cut the uniformity of the wall express a

new concept for heated towel rails that enliven and furnish bathroom walls.

The unusual and absolutely unexpected shape is as surprising as good sculpture can be.

DIMENSIONS

Widths: 30 / 36 cm
 Heights: 190 / 210 cm
 Depths: 14,5 cm
 Depths from wall: 15,5 cm

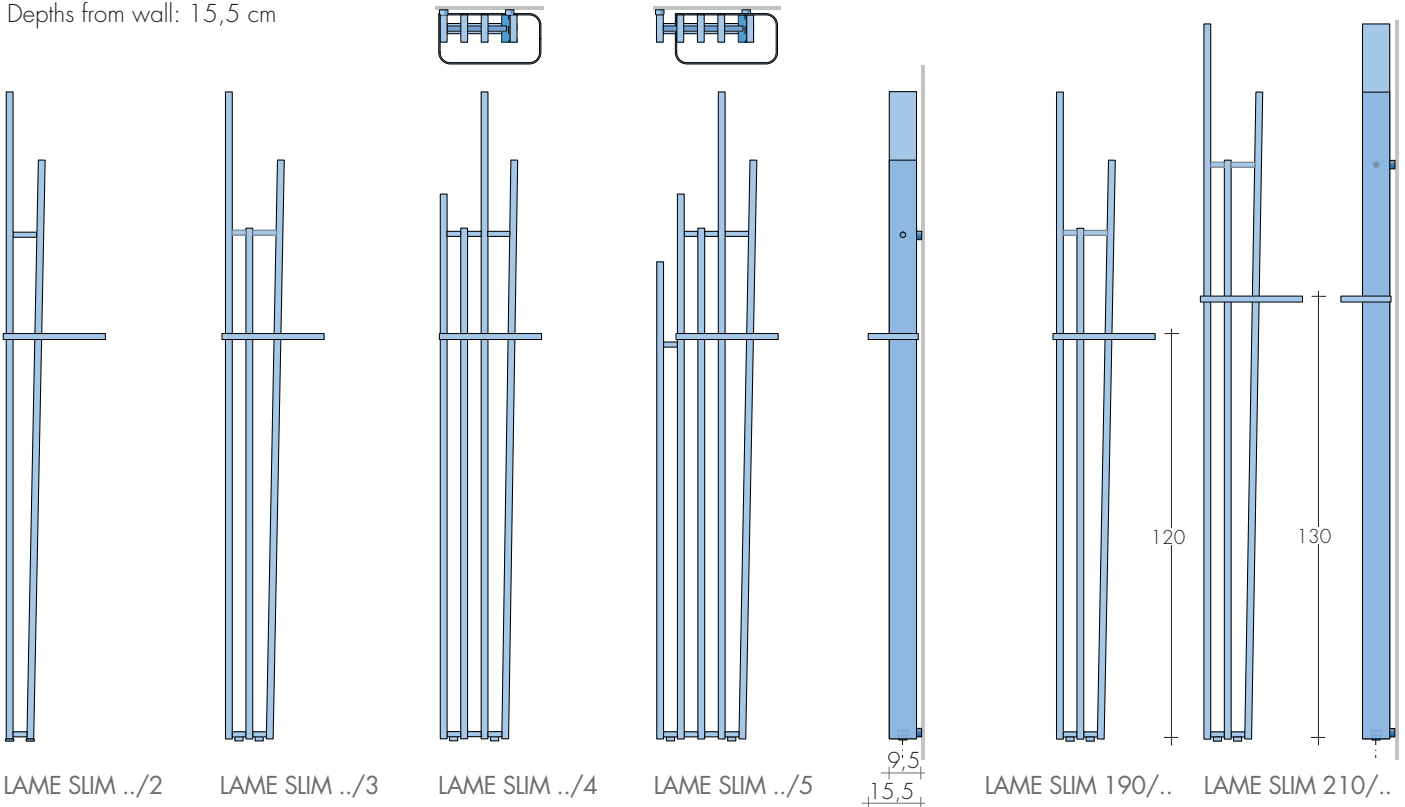

MODEL

MODEL	H-L cm	Standard white sablé SB 9016 €	EN 442			▲ ▽ t.c. cm	Height H cm	Width L cm	Weight M Kg	Volume V dm ³	DUAL FUEL VERSION with E.H.E. and sleeve	
			Δt 50 K watt	Δt 40 K watt	Δt 30 K watt						Watt	€
LAME Slim	190/2	713,10	350	258	182	6	190	30	10,8	4,7	400	127,40
LAME Slim	190/3	856,60	496	366	258	6	190	30	15,4	6,7	500	129,60
LAME Slim	190/4	999,80	652	481	339	12	190	30	20,2	8,8	650	131,80
LAME Slim	190/5	1157,10	788	582	410	18	190	36	24,4	10,6	800	136,60
LAME Slim	210/2	755,20	389	287	202	6	210	30	12,0	5,2	400	127,40
LAME Slim	210/3	918,70	554	409	288	6	210	30	17,2	7,5	500	129,60
LAME Slim	210/4	1081,70	730	539	380	12	210	30	22,6	9,9	800	136,60
LAME Slim	210/5	1259,30	885	653	460	18	210	36	27,4	11,9	900	140,20

► Available in Stock

Thermostats p.208-209

STANDARD PRODUCTION

White sablé SB9016 paintwork - brackets B15
 Tolerance ± 3mm - Air vent ø 1/8"
 MAXIMUM OPERATING PRESSURE 4 BAR

PRODUCTION ON REQUEST

Paintwork to Brem color list with
 colored brackets B15 +15%/25%
 Electric version e.Lame Slim, p.242

STANDARD FITTING

EG ø 1/2"
 On request fittings ø 3/8"
 Special fittings, page 279



TAPPING CENTRES

LAME SLIM ../2

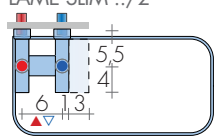

LAME SLIM ../3

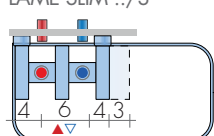

LAME SLIM ../4

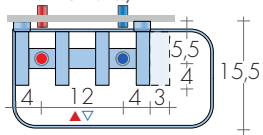

LAME SLIM ../5

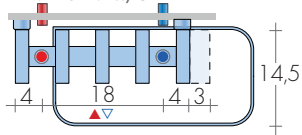

MIXED VERSIONS*

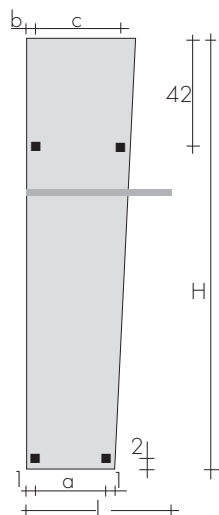
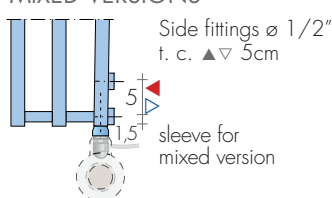

FIXINGS

B15 brackets included,
B27 with remote fittings
and B35 Lame ../2

Mod.	a	b	c
n° tubes	cm	cm	cm
2	6	1	9
3	12	1	15
4	18	1	21
5	24	7	21



LAME SLIM 190/3

RECOMMENDED VALVES

CHROME VALVES KIT with:

- n°2 Valves with tailpieces
- n°2 Fittings (multilayer \varnothing 16, copper \varnothing 12, 14)
- n°2 Chrome wall plates \varnothing 48, hole \varnothing 16

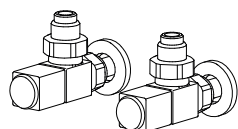

ANGLED QUADRA VALVES KIT
page 271 Art. KQS 180,10€
Extra for BREM color list 53,40€

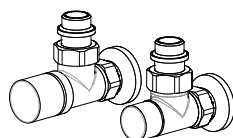

ANGLED CYL VALVES KIT with THERMOSTATIC
option, page 273 Art. KCS 149,90€
Extra for BREM color list 53,40€

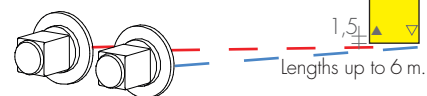

SPECIAL FINISHES page 267
Finishes Gold, Bronze, Brushed Nickel for 2 valves
Brushed Nickel FITTING KIT extra Art. RN 30,50€

REMOTE FITTINGS Art. REM 42,10€
Tapping centres: at the rear of radiator \blacktriangle \blacktriangledown EG
DISTANT Valves page 274

ANGLED TON VALVES KIT with THERMOSTATIC
Head, page 269 Art. KTS 190,30€



CrossFRAME INDEX

RADIATORS WITH FRAMES

RADIATORS COLLECTION

	page
CROSS-Q	44
CROSS-G	46
CROSS-V	50

TOWEL HEATERS COLLECTION

	page
ALIS-ONE	52
ASYMM-ASYMP	54
CROSS	56
CROSS-Q	60
CROSS-FO/BIC	62
CROSS-CROM	63
CROSS-R	66
CROSS-RV	68
ESSEN	70
FIT	72
FREE	74
KORE PLUS	76
PIT	78
QUAR	80
VISION	82



CROSS-Q WITH OVERLAPPING SQUARES

design Luigi Brembilla

Large, variously assembled, rectangular tubes are used to produce CROSS-Q.

Innovative radiators thanks to 90° corners and strong geometric shapes (squares and

rectangles) sitting on top of each other.

DIMENSIONS

Width: 48/56/64/100/116 cm

Height: 170/186/202/226/230 cm

Depth: 6 /7 cm

Depth from wall: 9,5 cm

TECHNICAL DRAWINGS on request

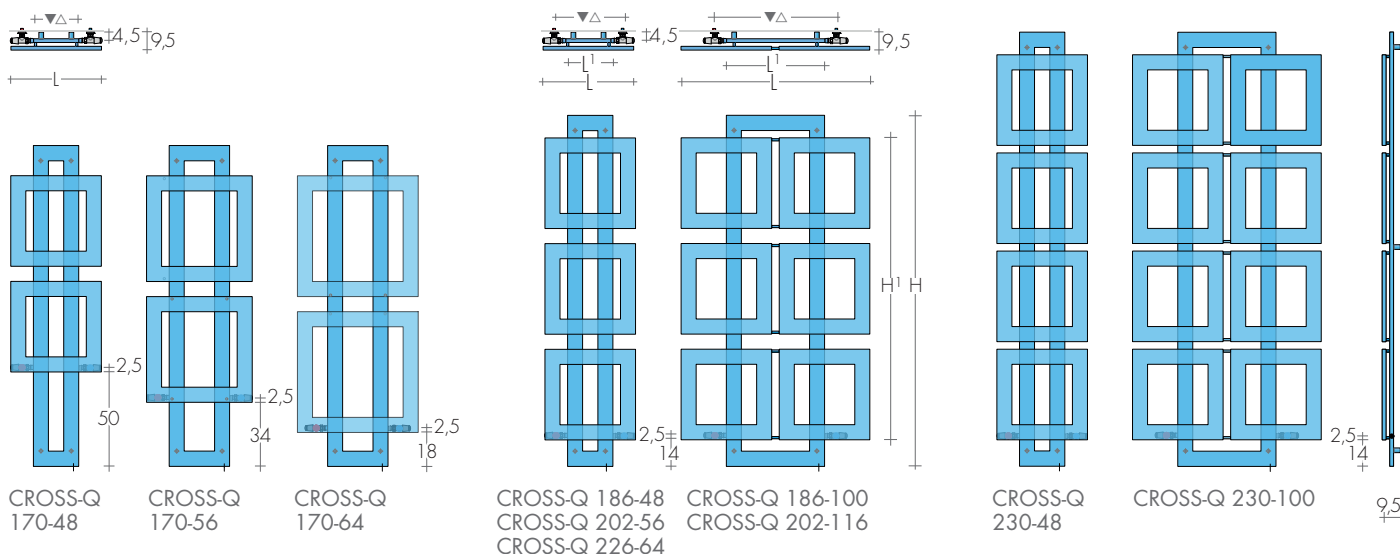

MODEL'25

MODEL'25	HxL cm	Standard white sablé SB9016 €	EN 442			▲▽ t.c. cm	Height H (H1) cm	Width L (L1) cm	Weight M Kg	Volume V dm³	DUAL FUEL VERSION with E.H.E. and sleeve	
			Δt 50K watt	Δt 40K watt	Δt 30K watt						Watt	€
CROSS-Q	170-48	1244,20	711	537	374	37	170 (104)	48 (24)	14,2	8,8	650	131,80
CROSS-Q	170-56	1290,40	795	600	418	45	170 (120)	56 (32)	15,9	9,9	800	136,60
CROSS-Q	170-64	1333,00	863	652	454	45	170 (136)	64 (32)	17,2	10,7	900	140,20
CROSS-Q	186-48	1310,20	894	675	470	37	186 (160)	48 (24)	18,7	11,3	900	140,20
CROSS-Q	186-100	2132,50	1446	1092	761	65	186 (160)	100 (52)	30,2	18,3	1500	159,40
CROSS-Q	202-56	1374,60	1026	775	557	45	202 (176)	56 (32)	22,1	13,4	1200	148,50
CROSS-Q	202-116	2245,60	1677	1266	892	65	202 (176)	116 (52)	35,4	21,5	1500	159,40
CROSS-Q	226-64	1440,00	1174	886	635	45	226 (200)	64 (32)	25,2	15,3	1200	148,50
CROSS-Q	230-48	1579,50	1138	859	593	37	230 (204)	48 (24)	24,0	14,6	1200	148,50
CROSS-Q	230-100	2667,20	1830	1382	964	65	230 (204)	100 (52)	39,1	23,7	-	-

Thermostats p.208-209

STANDARD PRODUCTION

White sablé SB9016 paintwork - B35 brackets
Tolerance ± 3mm - Air vent ø 1/8"

MAXIMUM OPERATING PRESSURE 4 BAR

PRODUCTION ON REQUEST

Paintwork to Brem color list with colored
brackets B35 +15/25%

Electric version e.Cross-Q, p.221

STANDARD FITTING

REG ø 1/2"

On request fitting ø3/8"

Special fittings, page 278



TAPPING CENTRES
CROSS-Q

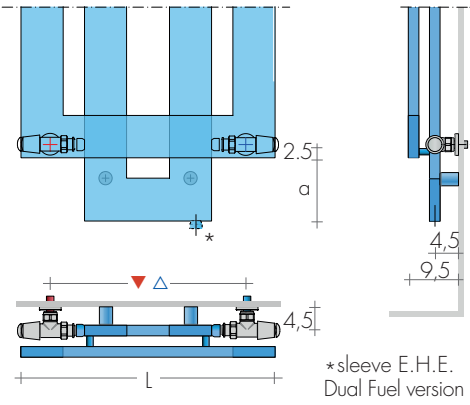

- CROSS 170-48 a=50
- CROSS 170-56 a=34
- CROSS 170-48 a=18
- CROSS from 186... a=14

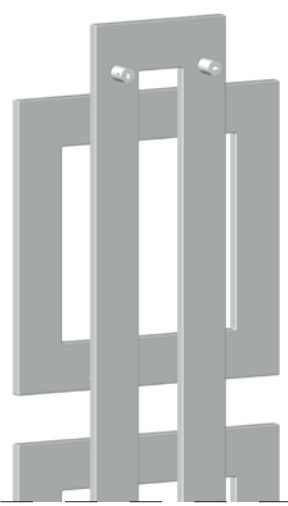

FIXINGS
Brackets B35
included



CROSS-Q 186-100

RECOMMENDED VALVES

- CHROME VALVES KIT with:
- n°2 Valves with tailpieces
 - n°2 Fittings (multilayer ø 16, copper ø 12, 14)
 - n°2 Chrome wall plates ø 48, hole ø 16

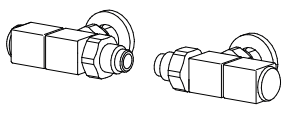

REVERSE VALVES QUADRA KIT
page 271 Art. KQR 180,10€
Extra for BREM color list 53,40€

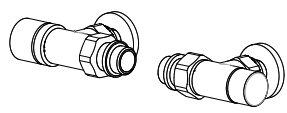

REVERSE CYL VALVES KIT with THERMOSTATIC
option, page 273 Art. KCR 149,90€
Extra for BREM color list 53,40€

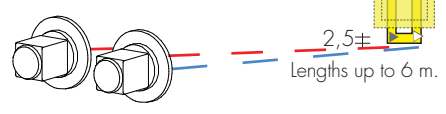

SPECIAL FINISHES page 267
Finishes Gold, Bronze, Brushed Nickel for 2 valves
Brushed Nickel FITTING KIT extra Art. RN 30,50€

REMOTE FITTINGS Art. REM 42,10€
Tapping centres at the rear: ▲▽ L¹ - 6cm
DISTANT Valves page 274

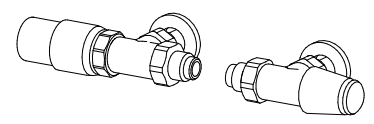

REVERSE VALVES TON KIT with THERMOSTATIC
Head, page 273 Art. KTR 190,30€

CROSS-G

design Luigi Brembilla

CROSS-G radiator, only 2 cm of depth, consists of a large rectangular frame,

elegant and protagonist, enriched by vertical tubes and thin steel strips, to obtain

high yields. Its particular design makes it suitable to be used in every room.

CGH MODEL with vertical radiating tubes

Heights: from 51 to 241 cm

Lengths: from 27 to 99 cm

Depth: 2 cm

Depth from wall: 5,5 cm

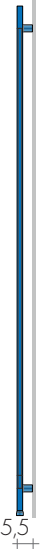
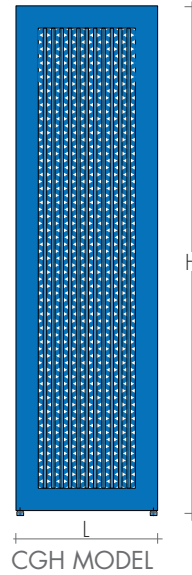

CGV MODEL with horizontal radiating tubes

Heights: from 27 to 99 cm

Lengths: from 51 to 221 cm

Depth: 2 cm

Depth from wall: 5,5 cm

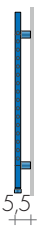
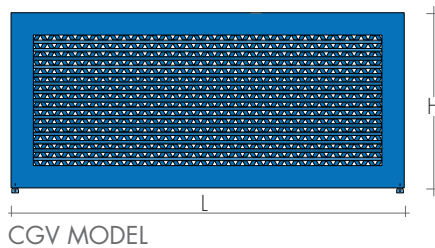

STANDARD PRODUCTION

White sablé SB9016 paintwork - Brackets B35

Tolerance ± 3 mm - Air vent $\varnothing 1/8"$

MAXIMUM OPERATING PRESSURE 4 BAR

PRODUCTION ON REQUEST

Paintwork to Brem color list with

colored B35 brackets

Electric version, p. 220

+15/25%

STANDARD FITTING

EG $\varnothing 1/2"$

On request fitting $\varnothing 3/8"$

Special fittings, page 278



TAPPING CENTRES

EG vertical fittings as standard
Side fittings on request without extra

CGH MODEL

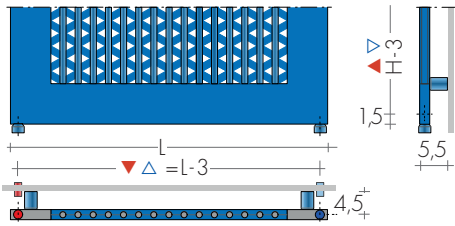

CGV MODEL

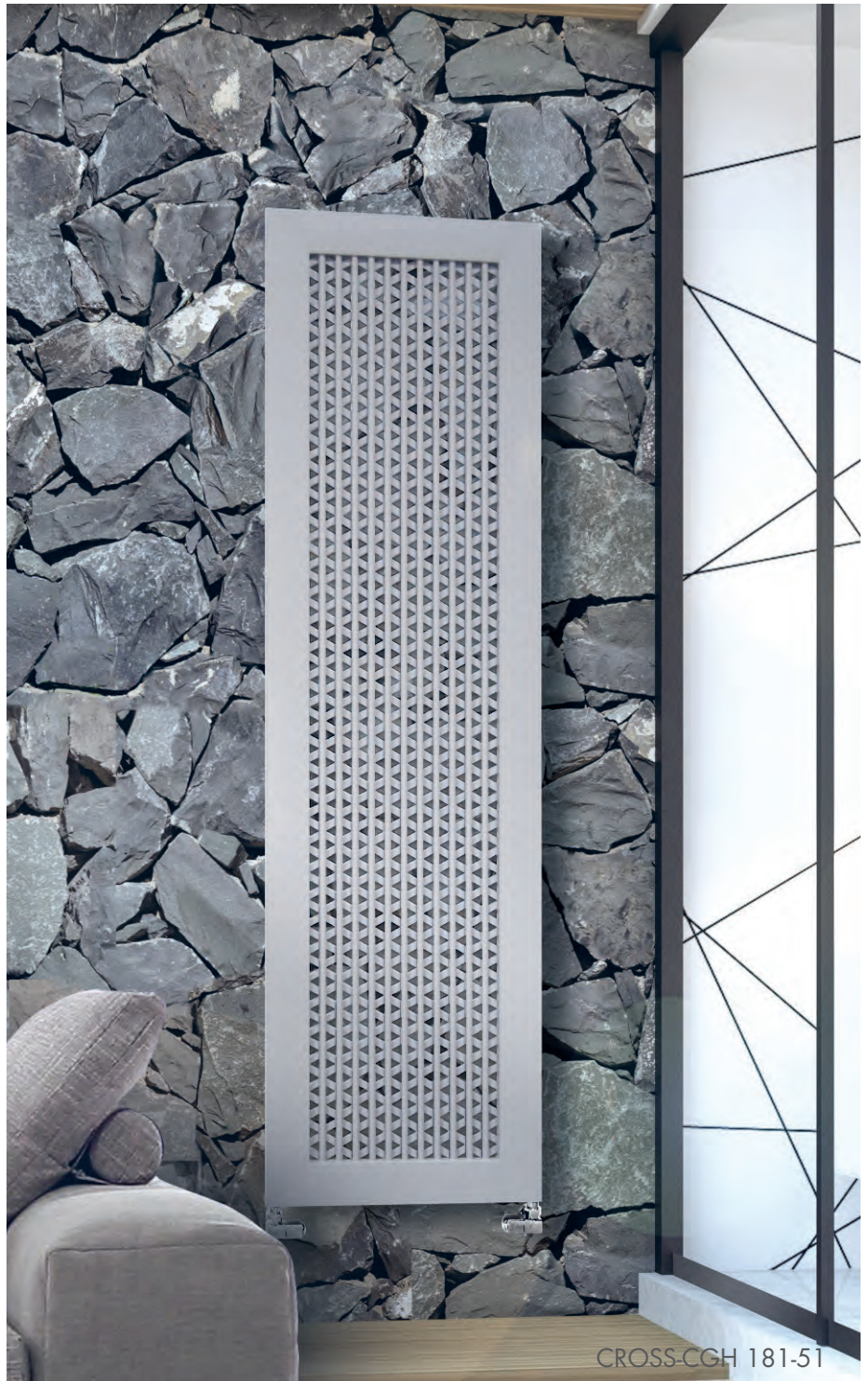
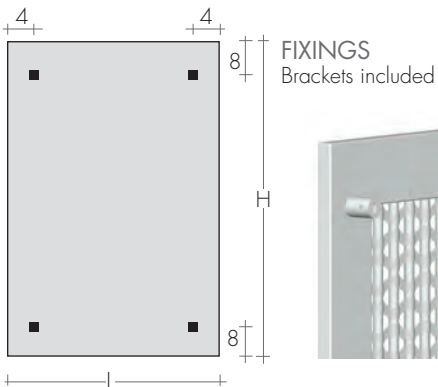
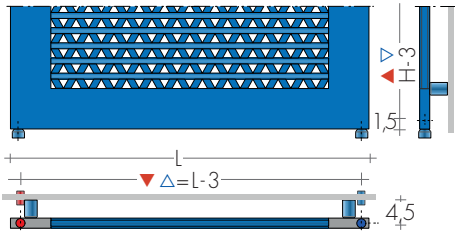

RECOMMENDED VALVES

CHROME VALVES KIT with:

- n°2 Valves with tailpieces
- n°2 Fittings (multilayer \varnothing 16, copper \varnothing 12, 14)
- n°2 Chrome wall plates \varnothing 48, hole \varnothing 16

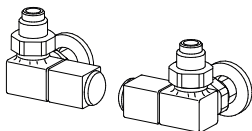

SIDE CONTROL QUADRA VALVES KIT
page 271 Art. KQL 191,20€
Extra for BREM color list 53,40€

SPECIAL FINISHES

page 267
Finishes Gold, Bronze, Brushed Nickel for 2 valves
Brushed Nickel FITTING KIT extra Art. RN 30,50€

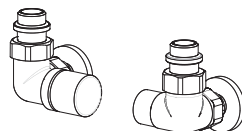

SIDE CONTROL CYL VALVES KIT with thermostatic
option, page 273 Art. KCL 162,50€
Extra for BREM color list 53,40€

REMOTE FITTINGS

Art. REM 42,10€
Tapping centres: at the rear of radiator $\blacktriangle \nabla$ L - 6cm
DISTANT Valves page 274

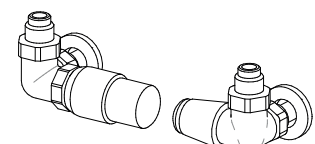
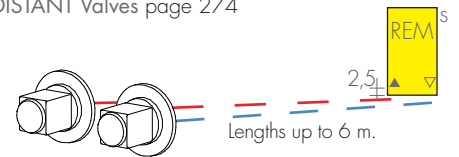

SIDE CONTROL TON VALVES KIT with THERMO-
STATIC Head, page 269 Art. KTL 203,70€

CROSS-CGH

EN 442 Watt Δt 50K (Δt 40K = Wx0,755) - (Δt 30K = Wx0,526)

MOD.	H cm	L cm	Lengths/Longueurs												
			27	33	39	45	51	57	63	69	75	81	87	93	99
	▲▼ cm		24	30	36	42	48	54	60	66	72	78	84	90	96
CGH 51	€	603,50 170w	660,70 205w	717,80 240w	775,20 275w	832,30 310w	889,50 345w	946,70 380w	1003,90 415w	1061,10 450w	1118,20 485w	1175,60 520w	1232,70 555w	1289,90 590w	
CGH 71	€	671,30 234w	728,60 281w	785,80 329w	842,90 376w	900,10 424w	957,40 471w	1014,50 518w	1071,80 566w	1129,00 613w	1186,20 661w	1243,40 708w	1300,70 755w	1357,80 803w	
CGH 91	€	739,20 297w	796,40 357w	853,70 417w	910,80 477w	968,10 537w	1025,20 597w	1082,50 656w	1139,70 716w	1196,90 776w	1254,10 836w	1311,30 896w	1368,50 956w	1425,60 1016w	
CGH 161	€	976,80 519w	1034,10 623w	1091,20 726w	1148,40 830w	1205,70 933w	1262,90 1036w	1320,00 1140w	1377,40 1243w	1434,50 1347w	1491,70 1450w	1549,00 1554w	1606,10 1657w	1663,30 1760w	
CGH 181	€	1044,70 583w	1102,00 699w	1159,20 814w	1216,30 930w	1273,70 1046w	1330,80 1162w	1387,90 1278w	1445,10 1394w	1502,40 1510w	1559,60 1626w	1616,70 1741w	1674,10 1857w	1731,20 1973w	
CGH 191	€	1078,70 614w	1135,90 736w	1193,00 859w	1250,40 981w	1307,50 1103w	1364,70 1225w	1422,00 1347w	1479,20 1469w	1536,30 1591w	1593,50 1713w	1650,80 1835w	1707,90 1957w	1765,20 2080w	
CGH 201	€	1112,60 646w	1169,80 774w	1227,10 903w	1284,20 1031w	1341,40 1159w	1398,70 1288w	1455,90 1416w	1513,00 1544w	1570,40 1673w	1627,50 1801w	1684,70 1929w	1741,90 2058w	1799,10 2186w	
CGH 211	€	1146,70 678w	1203,80 812w	1261,00 947w	1318,10 1081w	1375,50 1216w	1432,60 1351w	1489,70 1485w	1547,10 1620w	1604,20 1754w	1661,40 1889w	1718,60 2023w	1775,90 2158w	1833,00 2292w	
CGH 221	€	1180,50 710w	1237,70 850w	1294,90 991w	1352,20 1132w	1409,30 1273w	1466,60 1413w	1523,80 1554w	1581,00 1695w	1638,20 1836w	1695,30 1976w	1752,60 2117w	1809,70 2258w	1867,00 2399w	
CGH 231	€	1214,40 741w	1271,60 888w	1328,90 1035w	1386,00 1182w	1443,30 1329w	1500,50 1476w	1557,70 1623w	1614,90 1770w	1672,20 1917w	1729,30 2064w	1786,60 2211w	1843,70 2358w	1900,90 2505w	
CGH 241	€	1248,50 773w	1305,60 926w	1362,80 1079w	1420,00 1233w	1477,20 1386w	1534,40 1539w	1591,60 1692w	1648,90 1845w	1706,00 1999w	1763,30 2152w	1820,40 2305w	1877,70 2458w	1934,90 2611w	

Δt different from 50 K: consult Technical data Brem

HOW TO ORDER

State: model, height and width in cm; connection and color if different from standard.
eg.: CGH 181 - 39, EG \varnothing 1/2", SB 5002

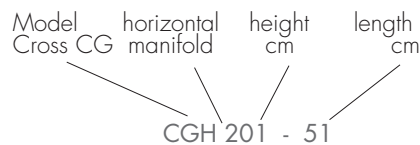

PRODUCTION ON REQUEST

Thermal output and prices can be obtained by interpolation:
- length of manifolds every 3 cm
- height of radiating tubes every 10 cm

Made-to-measure (± 3 mm)

Sizes over 3 m: price on request
Height every 5 cm: increased size +10%

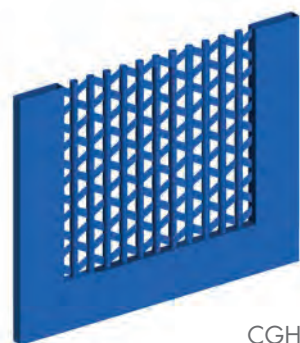

CGH

DOUBLE VERSION CGDH
by joining two CGH radiators

Standard EG fitting (delivery and return at front), B15 brackets.
Thermal output CGDH: single radiator x 1,65

PRICE CGDH

CGH x 2 + 140,00€

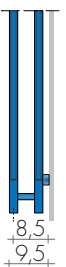

CROSS - CGV

EN 442 Watt Δt 50K (Δt 40K = Wx0,755) - (Δt 30K = Wx0,526)

MOD.	L cm ▲ ▼ cm	Lengths/Longueurs									
		51	71	91	101	121	141	161	181	201	221
CGV 27	€	603,50 176w	671,30 241w	739,20 306w	773,20 339w	841,10 404w	908,90 470w	976,80 535w	1044,70 600w	1112,60 666w	1180,50 731w
CGV 33	€	660,70 212w	728,60 290w	796,40 368w	830,40 407w	898,20 485w	966,20 563w	1034,10 641w	1102,00 720w	1169,80 798w	1237,70 876w
CGV 39	€	717,80 248w	785,80 339w	853,70 430w	887,50 475w	955,50 566w	1023,30 657w	1091,20 748w	1159,20 839w	1227,10 930w	1294,90 1021w
CGV 45	€	775,20 284w	842,90 387w	910,80 491w	944,80 543w	1012,70 647w	1080,60 751w	1148,40 854w	1216,30 958w	1284,20 1062w	1352,20 1166w
CGV 51	€	832,30 320w	900,10 436w	968,10 553w	1002,00 611w	1069,90 728w	1137,80 844w	1205,70 961w	1273,70 1078w	1341,40 1194w	1409,30 1311w
CGV 57	€	889,50 356w	957,40 485w	1025,20 615w	1059,20 679w	1127,10 809w	1194,90 938w	1262,90 1067w	1330,80 1197w	1398,70 1326w	1466,60 1456w
CGV 63	€	946,70 392w	1014,50 534w	1082,50 676w	1116,40 747w	1184,40 890w	1252,20 1032w	1320,00 1174w	1387,90 1316w	1455,90 1458w	1523,80 1601w
CGV 69	€	1003,90 428w	1071,80 583w	1139,70 738w	1173,60 815w	1241,50 970w	1309,40 1125w	1377,40 1281w	1445,10 1436w	1513,00 1591w	1581,00 1746w
CGV 75	€	1061,10 464w	1129,00 632w	1196,90 799w	1230,80 883w	1298,60 1051w	1366,60 1219w	1434,50 1387w	1502,40 1555w	1570,40 1723w	1638,20 1891w
CGV 81	€	1118,20 500w	1186,20 680w	1254,10 861w	1288,10 952w	1356,00 1132w	1423,70 1313w	1491,70 1494w	1559,60 1674w	1627,50 1855w	1695,30 2036w
CGV 87	€	1175,60 536w	1243,40 729w	1311,30 923w	1345,20 1020w	1413,10 1213w	1481,10 1407w	1549,00 1600w	1616,70 1794w	1684,70 1987w	1752,60 2181w
CGV 93	€	1232,70 572w	1300,70 778w	1368,50 984w	1402,50 1088w	1470,30 1294w	1538,20 1500w	1606,10 1707w	1674,10 1913w	1741,90 2119w	1809,70 2326w
CGV 99	€	1289,90 608w	1357,80 827w	1425,60 1046w	1459,70 1156w	1527,50 1375w	1595,40 1594w	1663,30 1813w	1731,20 2032w	1799,10 2251w	1867,00 2471w

Δt different from 50 K: consult Technical data Brem

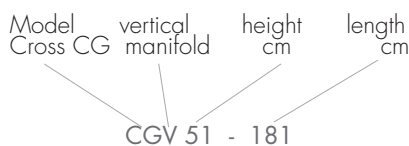

PRODUCTION ON REQUEST

Thermal output and prices can be obtained by interpolation:

- height of manifolds every 3 cm
- length of radiating tubes every 10 cm

Made-to-measure (± 3 mm)

Sizes over 3 m: price on request
Height every 5 cm: increased size +10%



DOUBLE VERSION CGDV
by joining two Cross-CGV radiators

Standard EG fitting (delivery and return at front),
B15 brackets
Thermal output CGDV: single radiator x1,65

PRICE CGDV CGV x 2 + 140,00€

CROSS-V

design Luigi Brembilla

Large, variously assembled, rectangular tubes are used to produce an innovative

radiator. CROSS-V represents absolute linearity: a simple or a double rectangle to

complete and add the variegated CROSS-Q solutions.

DIMENSIONS

Width 24/52/80/104/144 cm

Height 24/52/184/208/224 cm

Depth 2/8 cm

Depth from wall 5,5/11,5 cm

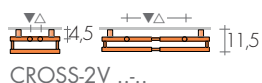
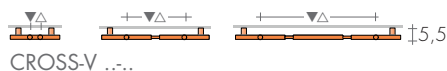
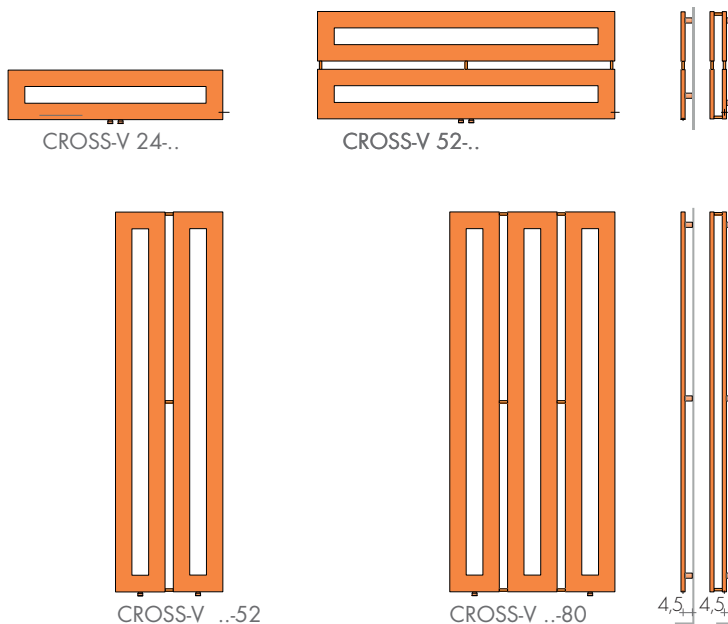

MODEL	HL cm	Standard white sablé SB 9016 €	Δt 50K watt	EN 442 Δt 40K watt	Δt 30K watt	▲ ▼ t.c. cm	Height H cm	Width L cm	Depth p cm	Weight M Kg	Volume V dm³	DUAL FUEL VERSION with E.H.E. and sleeve	
												Watt	€
CROSS-V	24-104	479,50	246	191	130	5	24	104	2	6,6	2,9	250	125,10
CROSS-V	24-144	605,50	334	259	176	5	24	144	2	9,6	4,0	300	126,20
CROSS-V	52-104	600,40	493	239	260	5	52	104	2	13,2	5,8	500	129,60
CROSS-V	52-144	772,20	669	307	353	5	52	144	2	9,7	8,0	650	131,80
CROSS-2V	24-104	912,90	429	362	226	5	24	104	8	13,1	5,9	400	127,40
CROSS-2V	24-144	1169,40	582	492	307	5	24	144	8	19,2	8,0	650	131,80
CROSS-2V	52-104	1140,80	857	430	452	5	52	104	8	26,4	11,6	900	140,20
CROSS-2V	52-144	1467,00	1164	552	614	5	52	144	8	8,3	16,0	1200	148,50
CROSS-V	184-24	581,30	422	311	223	5	184	24	2	16,6	5,0	400	127,40
CROSS-V	184-52	1059,20	845	621	446	28	184	52	2	24,9	10,1	800	136,60
CROSS-V	184-80	1465,30	1267	932	669	56	184	80	2	9,3	15,1	1200	148,50
CROSS-V	208-24	606,30	475	350	251	5	208	24	2	18,7	5,7	500	129,60
CROSS-V	208-52	1092,60	950	699	501	28	208	52	2	28,0	11,3	900	140,20
CROSS-V	208-80	1512,60	1426	1049	752	56	208	80	2	10,0	17,0	1500	159,40
CROSS-V	224-24	627,90	510	382	269	5	224	24	2	20,0	6,1	500	129,60
CROSS-V	224-52	1119,10	1021	764	539	28	224	52	2	30,0	12,1	900	140,20
CROSS-V	224-80	1570,20	1531	1146	808	56	224	80	2	16,6	18,3	1500	159,40
CROSS-2V	184-24	1104,70	735	560	388	5	184	24	8	33,2	10,0	650	131,80
CROSS-2V	184-52	2012,80	1470	1118	776	28	184	52	8	18,6	20,2	1500	159,40
CROSS-2V	208-24	1152,10	827	629	436	5	208	24	8	37,4	11,4	800	136,60
CROSS-2V	208-52	2075,70	1654	1259	873	28	208	52	8	20,0	22,6	1500	159,40

Thermostats p.208-209

MIXED VERSIONS Vertical models with thermostat

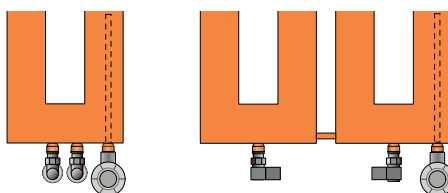

STANDARD PRODUCTION

White sablé SB9016 paintwork - B35 brackets
Tolerance ± 3mm - Air vent ø 1/8"

MAXIMUM OPERATING PRESSURE 4 BAR

PRODUCTION ON REQUEST

Paintwork to Brem color list with
colored B35 brackets

Electric version e.Cross-V, p.220

+15/25%

STANDARD FITTING

EG ø 1/2"

On request fitting ø 3/8"

Special fittings, page 278



TAPPING CENTRES

Horizontal models

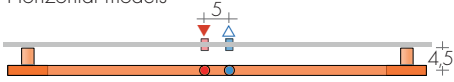

Vertical models

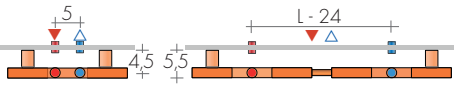

- Mod. L=24 ▼▲ 5 cm
- Mod. L=52 ▼▲ 28 cm
- Mod. L=80 ▼▲ 56 cm
- Mod. L=104 ▼▲ 5 cm
- Mod. L=144 ▼▲ 5 cm

FITTINGS AT THE REAR $\varnothing 1/2''$ on request

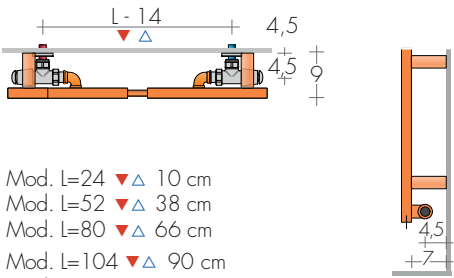

- Mod. L=24 ▼▲ 10 cm
- Mod. L=52 ▼▲ 38 cm
- Mod. L=80 ▼▲ 66 cm
- Mod. L=104 ▼▲ 90 cm
- Mod. L=144 ▼▲ 130 cm

On request, fittings at the rear with reverse valves:
▲▼ L-14cm extra Art. REG 91,20€

FIXINGS
B35 brackets included

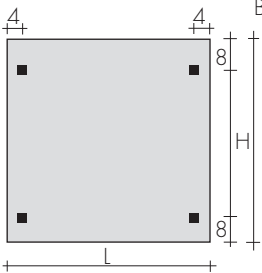

CROSS-2V 184-52

RECOMMENDED VALVES

CHROME VALVES KIT with:

- n°2 Valves with tailpieces
- n°2 Fittings (multilayer $\varnothing 16$, copper $\varnothing 12, 14$)
- n°2 Chrome wall plates $\varnothing 48$, hole $\varnothing 16$

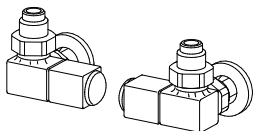

SIDE CONTROL QUADRA VALVES KIT
page 271 Art. KQL 191,20€
Extra for BREM color list 53,40€

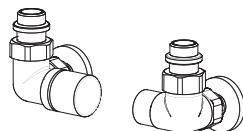

SIDE CONTROL CYL VALVES KIT with THERMO-
STATIC option, page 273 Art. KCL 162,50€
Extra for BREM color list 53,40€

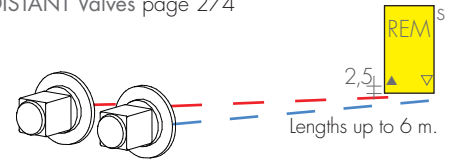

SPECIAL FINISHES page 267
Finishes Gold, Bronze, Brushed Nickel for 2 valves
Brushed Nickel FITTING KIT extra Art. RN 30,50€

REMOTE FITTINGS Art. REM 42,10€
Tapping centres: at the rear of radiator ▲▼ L-6cm
DISTANT Valves page 274

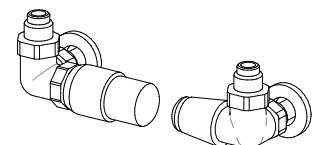

SIDE CONTROL TON VALVES KIT with THERMO-
STATIC Head, page 269 Art. KTL 203,70€

ALIS-ONE

design Luigi Brembilla

Its elegant, essential rectangular frame is enriched with horizontal tubes that act

as heated towel heaters. Reminiscent of the louvres found in sun blinds, the towel

heaters are slightly curved and slant downwards for easier, quicker drying.

DIMENSIONS:

Width: 51/91/121 cm

Height: 56/70/98/126/154/182 cm

Depth: 6 cm

Depth from wall: 9,5 cm



ALIS-ONE 56-51



ALIS-ONE 56-91



ALIS-ONE 56-121

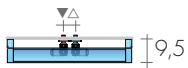

ALIS-ONE 70-51

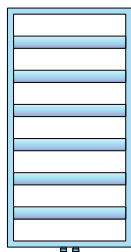

ALIS-ONE 98-51



ALIS-ONE 126-51



ALIS-ONE 154-51

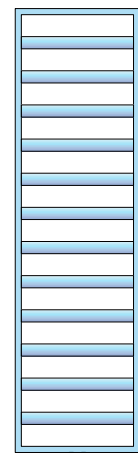

ALIS-ONE 182-51



MODEL	HxL cm	Standard white sablé SB9016 €	Δt 50 K watt	EN 442 Δt 40 K watt	Δt 30 K watt	▲▼ i.c. cm	Height H cm	Width L cm	Weight M kg	Volume V dm ³	DUAL FUEL VERSION with E.H.E. and sleeve Watt €	
ALIS-ONE 56-51	56-51	546,60	311	237	166	5	56	51	6,4	3,3	300	126,20
ALIS-ONE 56-91	56-91	640,00	491	373	262	5	56	91	9,8	4,9	500	129,60
ALIS-ONE 56-121	56-121	710,10	626	476	334	5	56	121	12,3	6,1	650	131,80
ALIS-ONE 70-51	70-51	586,00	379	288	202	5	70	51	7,6	3,9	400	127,40
ALIS-ONE 98-51	98-51	664,80	513	390	273	5	98	51	10,2	5,1	500	129,60
ALIS-ONE 126-51	126-51	743,70	648	493	345	5	126	51	12,7	6,2	650	131,80
ALIS-ONE 154-51	154-51	822,50	783	595	417	5	154	51	15,2	7,4	800	136,60
ALIS-ONE 182-51	182-51	901,40	918	698	489	5	182	51	17,7	8,5	900	140,20

Customized dimensions on request

Thermostats p.208-209

STANDARD PRODUCTION

White sablé SB9016 paintwork - B35 brackets

Tolerance ± 3mm - Air vent ø 1/8"

MAXIMUM OPERATING PRESSURE 4 BAR

PRODUCTION ON REQUEST

Paintwork to Brem color list with

colored B35 brackets

Electric version, e. Alis-One pag. 210

+15/25%

STANDARD FITTING

EG ø 1/2"

On request fitting ø 3/8"

Special fittings page 279



TAPPING CENTRES

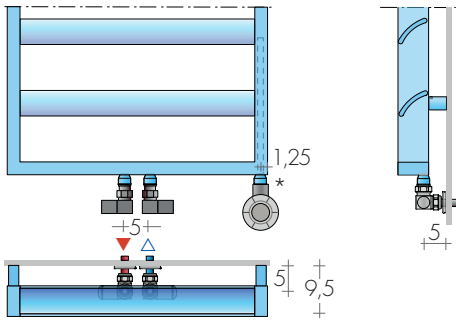

*sleeve E.H.E.
Dual Fuel version

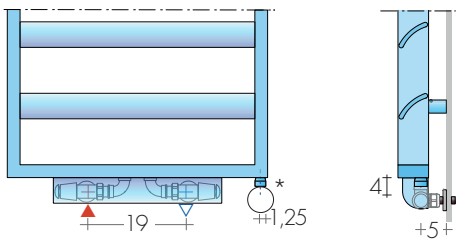

On request: VALVES COVER (32x6x6 cm)
with reverse valves ▲▽ 19cm Art. CR 101,40€

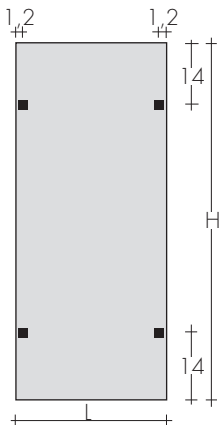
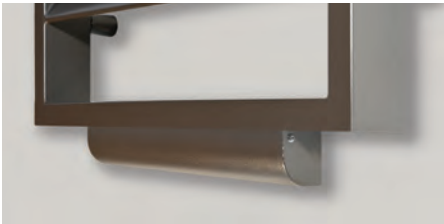

FIXINGS
B35 Brackets included



CrossFRAME

RECOMMENDED VALVES

CHROME VALVES KIT with:

- n°2 Valves with tailpieces
- n°2 Fittings (multilayer ø 16, copper ø 12, 14)
- n°2 Chrome wall plates ø 48, hole ø 16

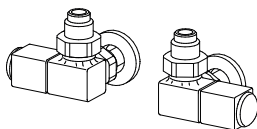

SIDE CONTROL QUADRA VALVES KIT
page 271 Art. KQL 191,20€
Extra for BREM color list 53,40€

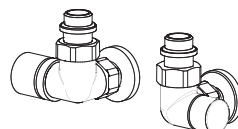

SIDE CONTROL CYL VALVES KIT with THERMO-
STATIC option, page 273 Art. KCLD 162,50€
Extra for BREM color list 53,40€

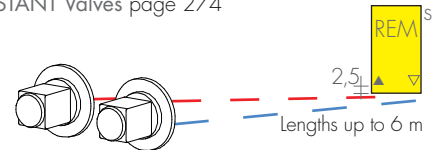

SPECIAL FINISHES page 267
Finishes Gold, Bronze, Brushed Nickel for 2 valves
Brushed Nickel FITTING KIT extra Art. RN 30,50€

REMOTE FITTINGS Art. REM 42,10€
Tapping centres: at the rear of radiator ▲▽ L - 6cm
DISTANT Valves page 274

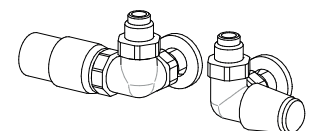

SIDE CONTROL TON VALVES KIT with THERMO-
STATIC Head, page 269 Art. KTLD 203,70€

ASYMM ASYMP

design Luigi Brebilla

ASYM: the heated towel heater with a simple design using a single tubular

section only 10 mm thick for a light and functional look.

A series of rectangular frames can be either empty or solid, and installed on either side.

DIMENSIONS

Width: 48 / 56 / 64 cm
 Height: 105 / 145 / 180 cm
 Depth: 4,8 cm
 Depth from wall: 7,6 cm

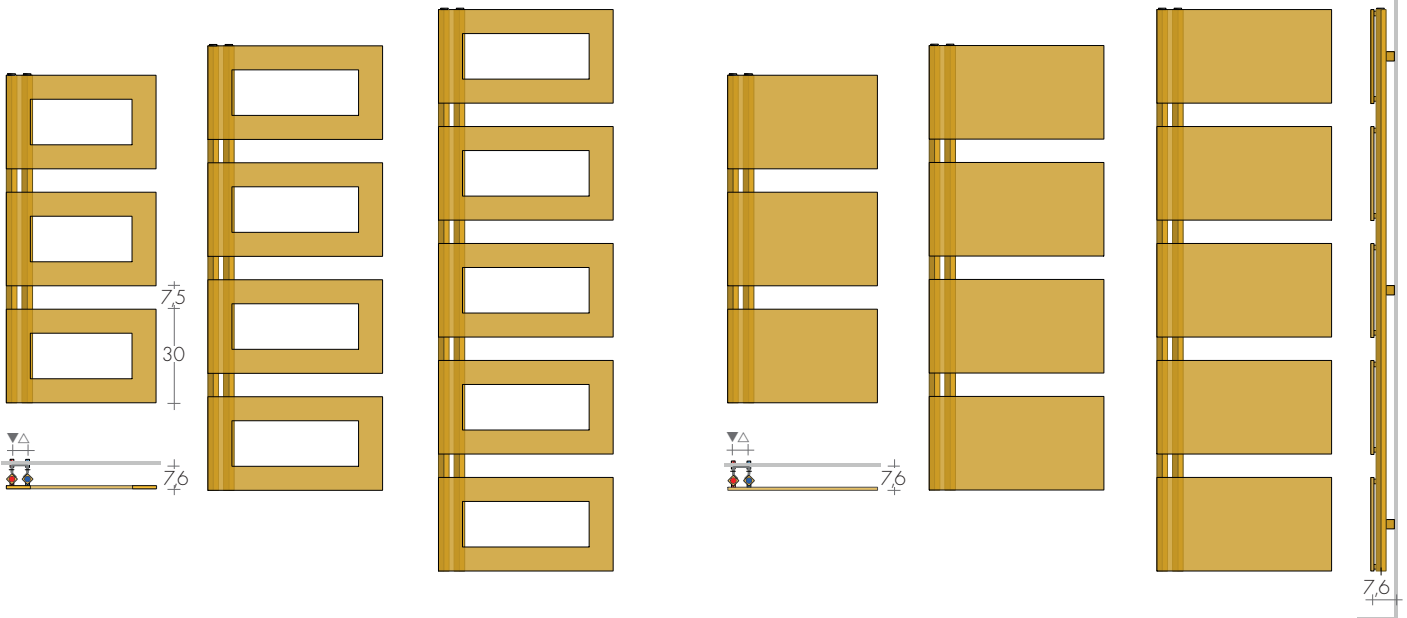

ASYMM 105-...

ASYMM 145-...

ASYMM 180-...

ASYMP 105-...

ASYMP 145-...

ASYMP 180-...

MODEL	Hl cm	Standard white sablé SB9016 €	Δt50K watt	EN 442 Δt40K watt	Δt30K watt	▲▼ t.c. cm	Height H cm	Width L cm	Weight M Kg	Volume V dm³	DUAL FUEL VERSION with E.H.E. *	
											Watt	€
ASYMM	105-48	695,30	506	382	266	5	105	48	9,2	3,5	500	129,60
ASYMM	105-56	736,30	556	420	292	5	105	56	10,1	3,8	500	129,60
ASYMM	145-48	841,60	677	511	356	5	142	48	12,3	4,8	650	131,80
ASYMM	145-56	882,60	744	562	391	5	142	56	13,5	5,1	800	136,60
ASYMM	145-64	923,60	811	612	427	5	142	64	14,6	5,5	800	136,60
ASYMM	180-48	963,30	849	641	447	5	180	48	15,5	6,0	900	140,20
ASYMM	180-56	1010,40	933	704	491	5	180	56	16,9	6,4	900	140,20
ASYMM	180-64	1057,30	1016	767	534	5	180	64	18,3	6,9	900	140,20
ASYMP	105-48	831,00	606	458	319	5	105	48	15,1	4,1	650	131,80
ASYMP	105-56	872,00	682	515	359	5	105	56	17,1	4,5	650	131,80
ASYMP	145-48	1018,00	811	612	427	5	142	48	20,2	5,5	800	136,60
ASYMP	145-56	1059,00	911	688	479	5	142	56	22,8	6,0	900	140,20
ASYMP	180-48	1139,70	1016	767	534	5	180	48	25,3	6,9	900	140,20
ASYMP	180-56	1180,70	1142	862	601	5	180	56	28,6	7,5	1200	148,50

▶ Ready in stock

*Dual fuel valve or T to be added p.207
 Thermostats p.208-209

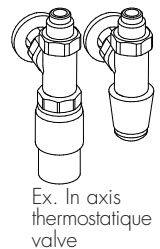
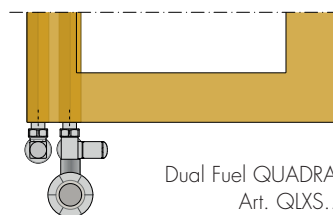

STANDARD PRODUCTION

White sablé SB9016 paintwork - B35 brackets
 Tolerance ± 3mm - Air vent ø 1/2"
 MAXIMUM OPERATING PRESSURE 4 BAR

PRODUCTION ON REQUEST

Paintwork to Brem color list with colored brackets +15/25%
 Electric version e.Asym, page 249

STANDARD FITTING

E ø 1/2",
 on request G
 Fittings on request, page 279

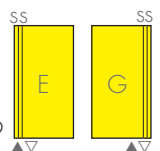

TAPPING CENTRES

ASYM with manifold on the left - E fittings

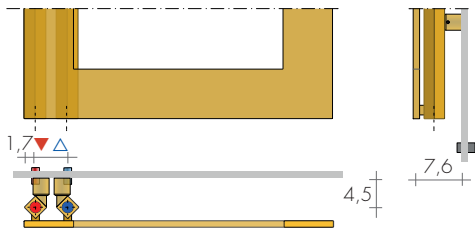

On request manifold on the right - G fittings

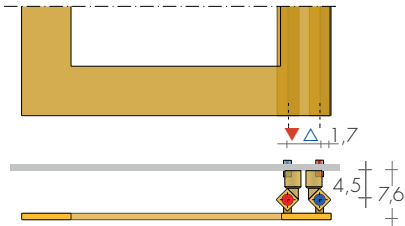

FIXINGS

Brackets included

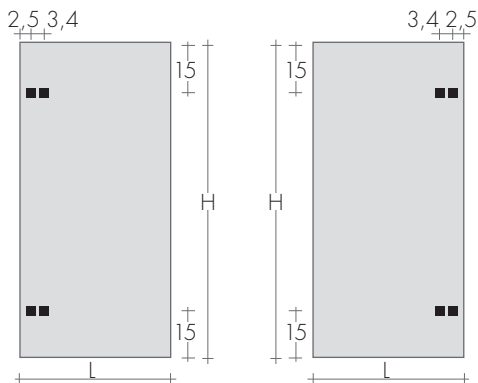

RECOMMENDED VALVES

CHROME VALVES KIT WITH:

- n°2 Valves with tailpieces
- n°2 Fittings (multilayer $\varnothing 16$, copper $\varnothing 12$, 14)
- n°2 Chrome wall plates $\varnothing 48$, hole $\varnothing 16$

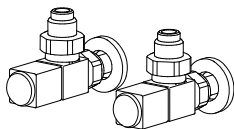

ANGLED QUADRA VALVES KIT

pag.271

Art. KQS 180,10€

Extra for BREM color list

53,40€

KIT Fitting Brushed NICKEL

Art. RN 30,50€

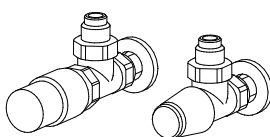

ANGLED TON VALVES KIT with THERMOSTATIC
Head chrome, p.269 Art. KTS 190,30€

ANGLED CYL VALVES convertible to thermostatic
chrome, p.273 Art. KCS 149,90€

Extra for BREM color list

53,40€

KIT Fitting brushed NICKEL

Art. RN 30,50€



ASYMM 145-56



ASYMP 105-48

CROSS WITH CROSSED SQUARES

design Luigi Brembilla

Interwoven squares and rectangles to create a radiator with an unusual look.

Can be used as a towelheater, or simply as decorative feature in any room.

The geometric shapes can be multiplied at will, always resulting in a harmonious whole.

DIMENSIONS

Width: 48/56/64/88/96/120/128/152/168 cm

Height: 48/56/64/88/128/152/168/184 cm

Depth: 11 cm

Depth from wall: 13,5 cm

TECHNICAL DRAWINGS p.59

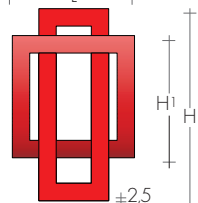
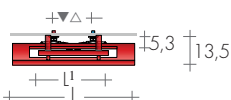

CROSS 88 -...

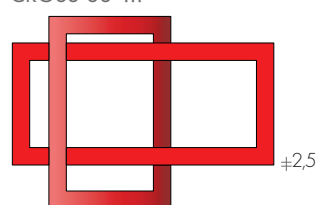

CROSS 88-120

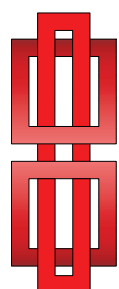

CROSS 128-48

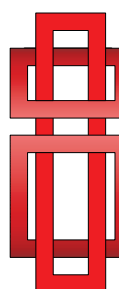

CROSS 128-56

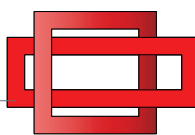

4,5 ±

CROSS 48-88
CROSS 56-88
CROSS 64-96

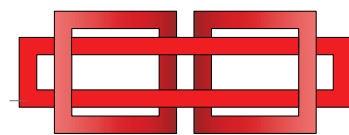

4,5 ±

CROSS 48-128 / 56-152 / 64-168

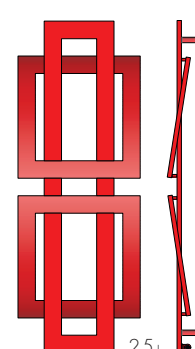

CROSS 152/168..

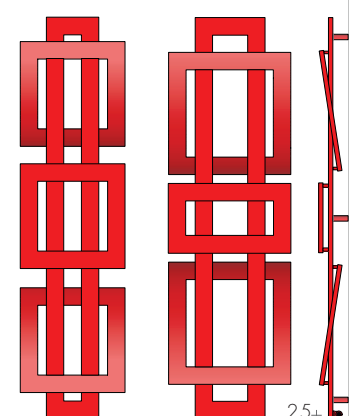

CROSS 184-48 CROSS 184-..

MODEL	H-L cm	Standard white sablé SB9016 €	EN 442			▲ ▼ t.c. cm	Height H (H1) cm	Width L (Li) cm	Weight M Kg	Volume V dm ³	DUAL FUEL VERSION with E.H.E. and sleeve Watt €	
			Δt 50K watt	Δt 40K watt	Δt 30K watt							
CROSS	48-88	768,20	394	297	208	74	48 (24)	88	7,9	4,8	400	127,40
CROSS	48-128	1066,50	635	479	335	114	48 (24)	128	12,8	7,7	650	131,80
CROSS	56-88	799,80	429	324	227	74	56 (32)	88	8,6	5,2	400	127,40
CROSS	56-152	1156,10	772	583	408	138	56 (32)	152	15,6	9,4	800	136,60
CROSS	64-96	867,60	480	362	253	82	64 (32)	96	9,7	5,9	500	129,60
CROSS	64-168	1209,30	892	673	471	154	64 (32)	168	17,6	10,7	900	140,20
CROSS	88-48	754,00	394	297	208	19	88	48 (24)	7,9	4,8	400	127,40
CROSS	88-56	784,80	429	324	227	19	88	56 (32)	8,6	5,2	400	127,40
CROSS	88-120	939,50	617	466	327	106	88	120 (56)	12,4	7,5	650	131,80
CROSS	128-48	1058,30	623	470	329	19	128	48 (24)	12,8	7,7	650	131,80
CROSS	128-56	1104,70	656	495	346	19	128	56 (32)	13,5	8,2	650	131,80
CROSS	152-48	1112,70	673	508	355	19	152	48 (24)	13,8	8,4	650	131,80
CROSS	152-56	1146,10	757	572	400	19	152	56 (32)	15,6	9,4	800	136,60
CROSS	168-64	1224,90	875	661	462	19	168	64 (32)	18,7	11,3	900	140,20
CROSS	184-48	1375,70	890	672	470	19	184	48 (24)	18,7	11,3	900	140,20
CROSS	184-56	1434,70	956	722	505	19	184	56 (32)	20,0	12,1	900	140,20
CROSS	184-64	1495,50	1038	784	548	19	184	64 (32)	21,8	13,2	1200	148,50
C-DIVIS*	196-48	1620,30	890	672	470	5	196	48+4	19,1	11,3	900	140,20

Ready Stock

Thermostats p.208-209

*Cross-Dividing to be used as a partition element with lateral fixings and foot (adjustable h=12/18 cm) welded, fixing B35 page 58

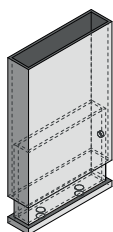

STANDARD PRODUCTION

White sablé SB9016 paintwork - B70 brackets

Tolerance ± 3mm - Air vent ø 1/8"

MAXIMUM OPERATING PRESSURE 4 BAR

PRODUCTION ON REQUEST

Paintwork to Brem color list with

colored B70 brackets

Electric versions e.Cross, p.218

+15/25%

STANDARD FITTING

REG ø 1/2"

On request fitting ø 3/8"

Special fittings, page 279

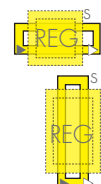

TAPPING CENTRES

Horizontal models

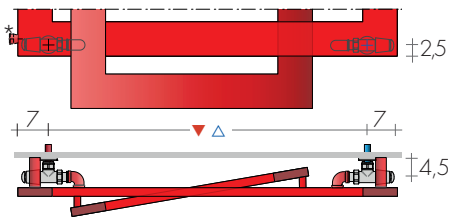

*sleeve E.H.E.
Dual Fuel version

Vertical models

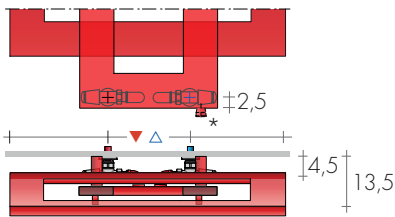

FIXINGS
Brackets included
position page 59



CROSS 184-56

RECOMMENDED VALVES

CHROME VALVES KIT with:

- n°2 Valves with tailpieces
- n°2 Fittings (multilayer ø 16, copper ø 12, 14)
- n°2 Chrome wall plates ø 48, hole ø 16

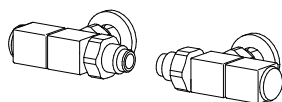

REVERSE QUADRA VALVES KIT
page 271 Art. KQR 180,10€
Extra for BREM color list 53,40€

SPECIAL FINISHES: Gold, Bronze, brushed Nickel,
gilden/silver Leaf for 2 valves page 267

Brushed Nickel FITTING KIT extra Art. RN 30,50€

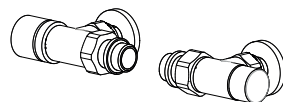

REVERSE CYL VALVES KIT with thermostatic option,
page 273 Art. KCR 149,90€
Extra for BREM color list 53,40€

REMOTE FITTINGS Art. REM 42,10€

Tapping centres: at the rear ▲▽ L¹ - 6cm

DISTANT Valves page 274

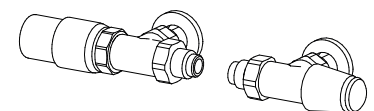
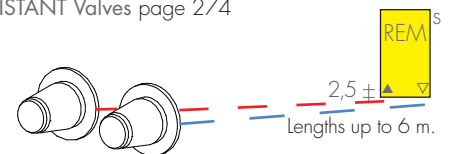

REVERSE VALVES TON KIT with THERMOSTATIC
Head, page 273 Art. KTR 190,30€



CROSS 48-128



CROSS 152-56



CROSS 184-56



C-DIVIS 196 - 48

CROSS DIVIS DIVIDING CROSS

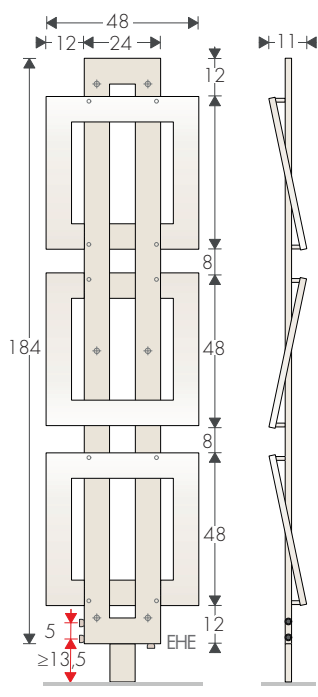

STANDARD FITTING
AC \varnothing 1/2"
BD on request

RECOMMENDED VALVES
STRAIGHT valves QUADRA KIT
p. 271 Art. KQD 190,00€

CROSS TECHNICAL DRAWINGS (CROSSED SQUARES)

TAPPING CENTRES AND FITTINGS

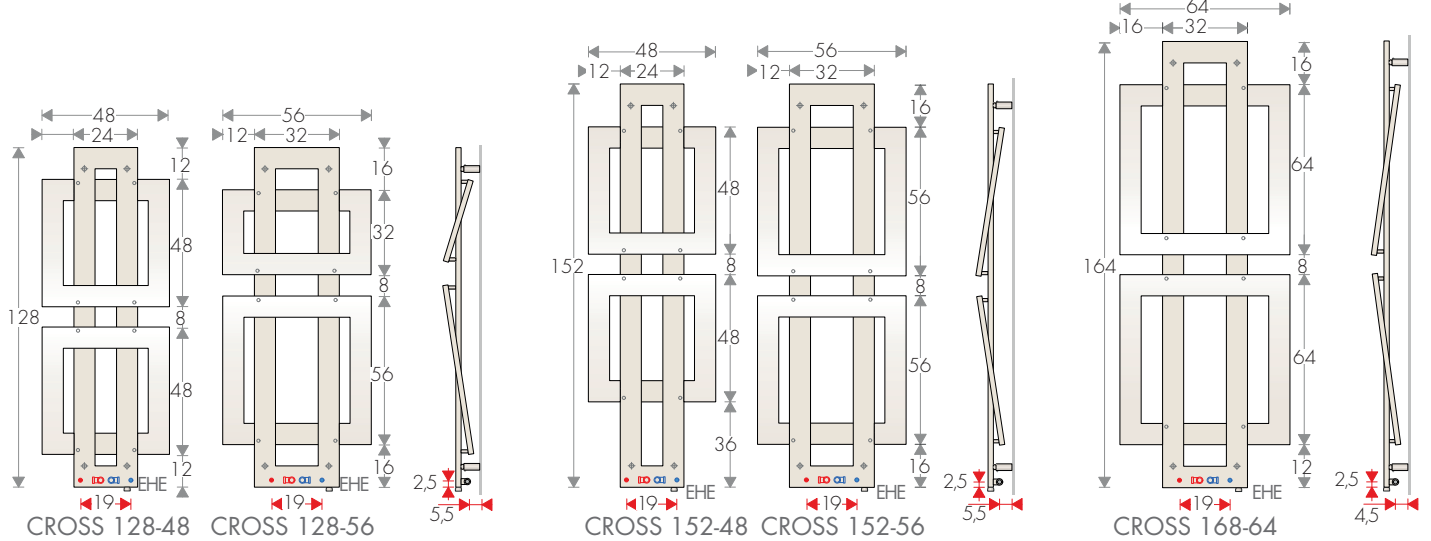
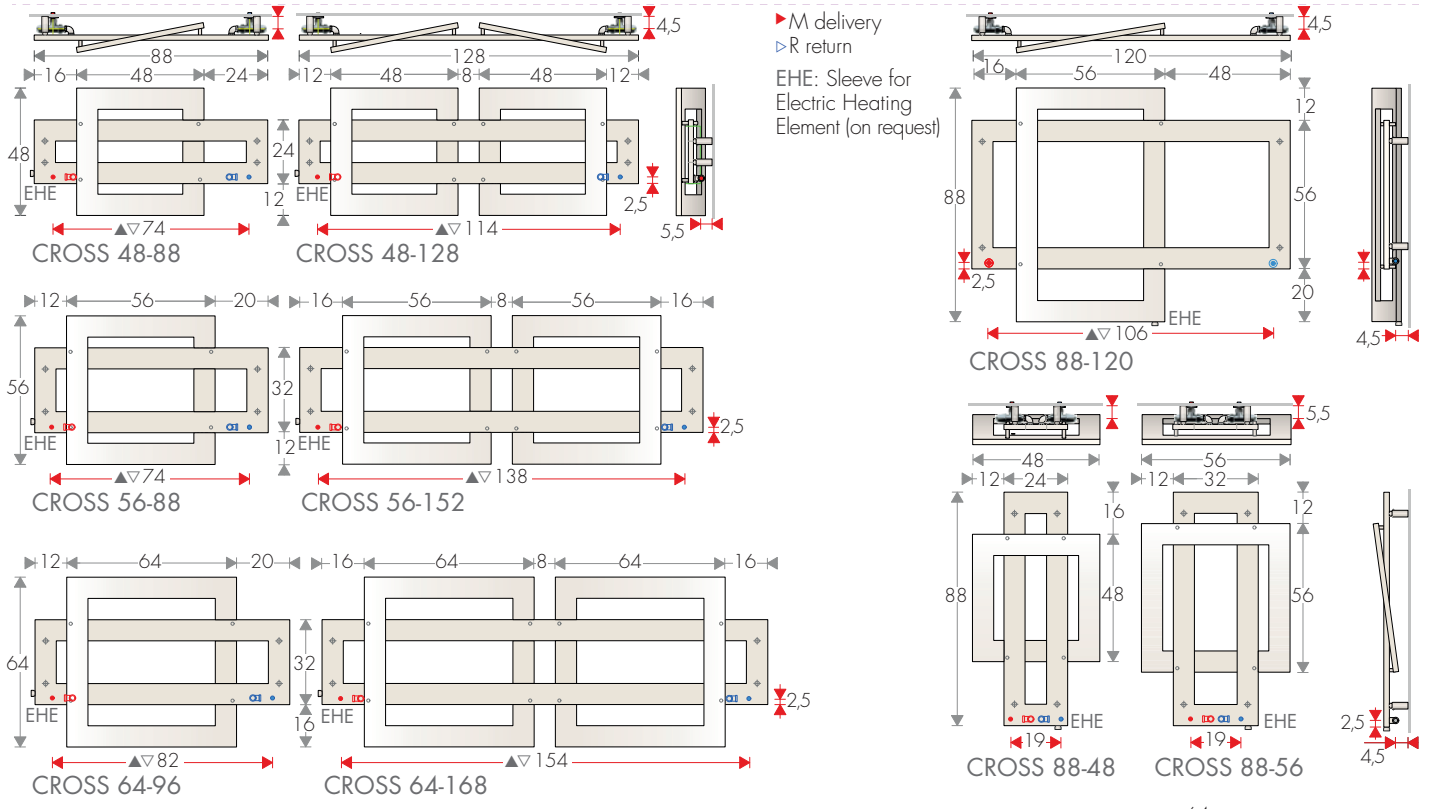

BRACKETS POSITION

HORIZONTAL models

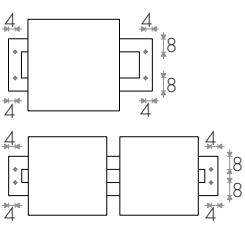

VERTICAL models

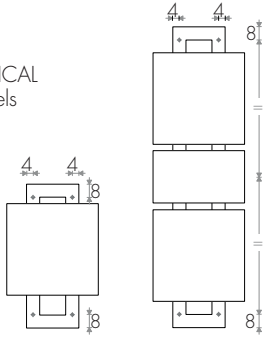

TAPPING CENTRES with REVERSE VALVES

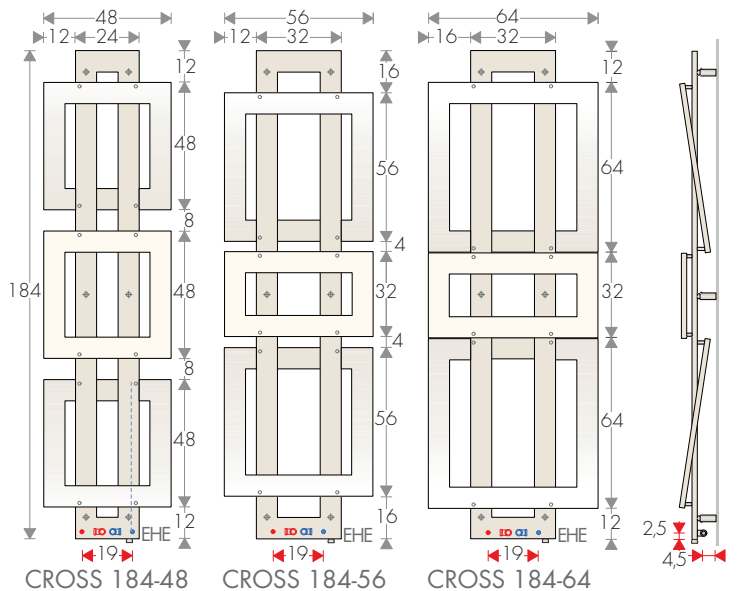
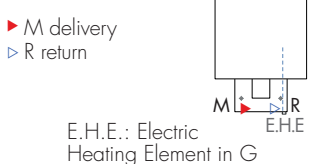
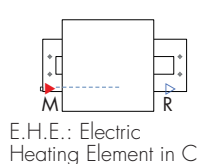

CROSS-Q

TOWEL HEATERS WITH OVERLAPPING SQUARES

design Luia Brembilla

Cross towel heaters can be provided in CROSS-Q version, with overlapping squares, to obtain a towel heaters 10 cm in depth only. Innovative element thanks to 90° corners and strong geometric shapes. Finishes can be chosen from the rich Brem color list

DIMENSIONS

Width: 48/56/64/88/96/120/128/152/168 cm

Height: 48/56/64/88/128/152/168/184 cm

Depth: 6 cm

Depth from wall: 9,5 / 13 cm

TECHNICAL DRAWINGS p.64

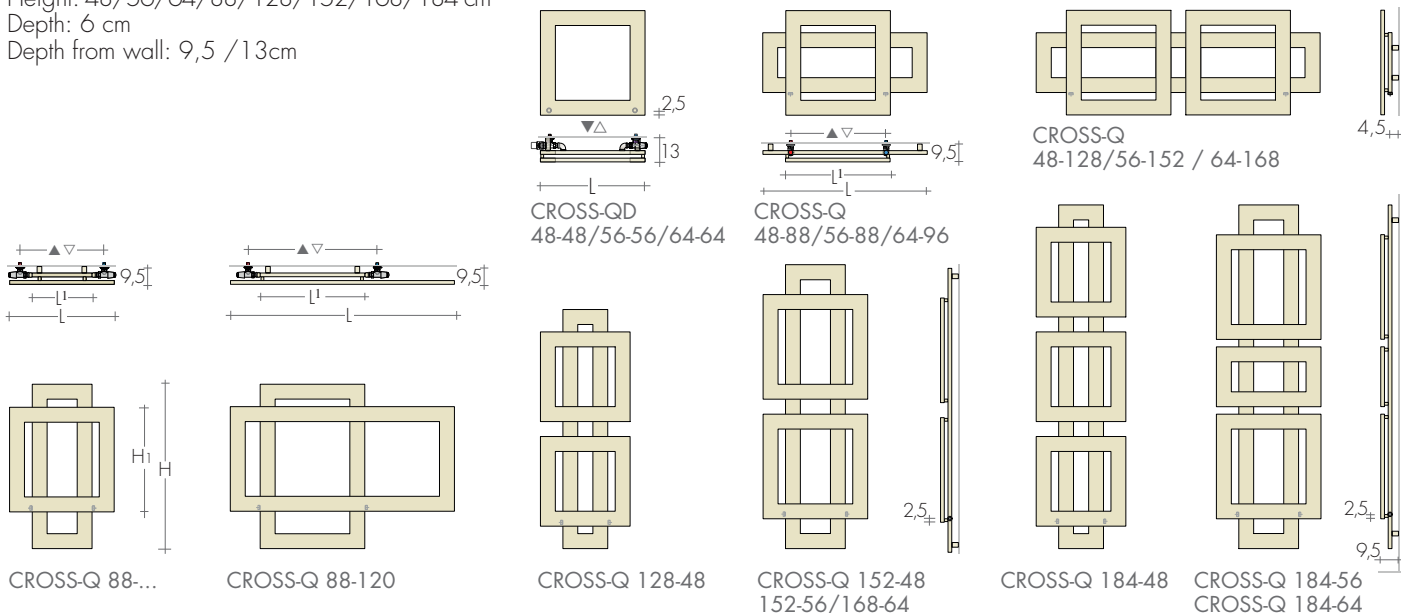

MODEL'25

	HL cm	Standard white sablé SB9016 €	Δt 50K watt	EN 442 Δt 40K watt	Δt 30K watt	▲ ▽ t.c. cm	Height H (Hi) cm	Width L (Li) cm	Weight M Kg	Volume V dm ³	DUAL FUEL VERSION with E.H.E. and sleeve Watt €	
CROSS-QD	48-48	465,40	244	184	128	38	48	48	6,5	5,2	250	125,10
CROSS-QD	56-56	506,70	292	220	154	46	56	56	7,7	6,2	300	126,20
CROSS-QD	64-64	531,80	339	256	178	54	64	64	9,0	7,1	400	127,40
CROSS-Q	48-88	731,70	394	297	208	43	48 (24)	88 (48)	7,9	4,8	400	127,40
CROSS-Q	48-128	1015,70	635	479	335	99	48 (24)	128 (104)	12,8	7,7	650	131,80
CROSS-Q	56-88	761,80	429	324	227	51	56 (32)	88 (56)	8,6	5,2	400	127,40
CROSS-Q	56-152	1101,00	772	583	408	115	56 (32)	152 (120)	15,6	9,4	800	136,60
CROSS-Q	64-96	826,10	480	362	253	59	64 (32)	96 (64)	9,7	5,9	500	129,60
CROSS-Q	64-168	1151,90	892	673	471	131	64 (32)	168 (136)	17,6	10,7	900	140,20
CROSS-Q	88-48	718,10	394	297	208	37	88	48 (24)	7,9	4,8	400	127,40
CROSS-Q	88-56	747,50	429	324	227	45	88	56 (32)	8,6	5,2	400	127,40
CROSS-Q	88-120	894,50	617	466	326	69	88	120 (56)	12,4	7,5	650	131,80
CROSS-Q	128-48	1008,00	623	470	329	37	128	48 (24)	12,8	7,7	650	131,80
CROSS-Q	128-56	1052,00	656	495	346	45	128	56 (32)	13,5	8,2	650	131,80
CROSS-Q	152-48	1059,70	673	508	355	37	152	48 (24)	13,8	8,4	650	131,80
CROSS-Q	152-56	1091,60	757	572	400	45	152	56 (32)	15,6	9,4	800	136,60
CROSS-Q	168-64	1166,60	875	661	462	45	168	64 (32)	18,7	11,3	900	140,20
CROSS-Q	184-48	1310,20	890	672	470	37	184	48 (24)	18,7	11,3	900	140,20
CROSS-Q	184-56	1366,50	956	722	505	45	184	56 (32)	20,0	12,1	900	140,20
CROSS-Q	184-64	1424,30	1038	784	548	45	184	64 (32)	21,8	13,2	900	140,20

► Ready Stock

Thermostats p.208-209



MIXED VERSION
with E.H.E. cable cover

STANDARD PRODUCTION

White sablé SB9016 paintwork - B35 brackets

Tolerance ± 3 mm - Air vent ø 1/8"

MAXIMUM OPERATING PRESSURE 4 BAR

PRODUCTION ON REQUEST

Paintwork to Brem color list with colored B35 brackets

Electric version e.Cross-Q, page 221

STANDARD FITTING

REG ø 1/2"

On request fitting ø 3/8"

Special fittings, page 279

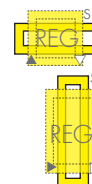

TAPPING CENTRES

Horizontal Models

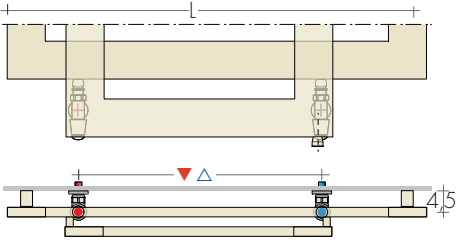

Vertical Models

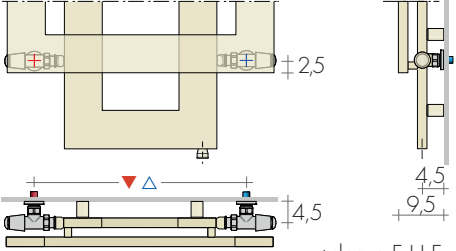

*sleeve E.H.E.
Dual Fuel version

CROSS-QD

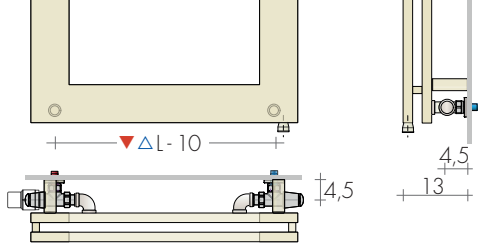

On request fittings EG ▲▽ L-10 cm without extra.
Visible valves with lateral control and depth 9.5 cm

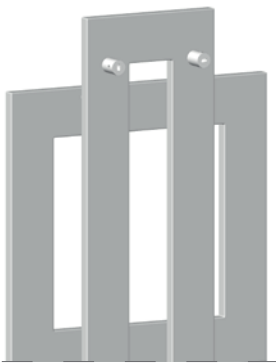

B35 FIXINGS
Brackets included
position page 64



RECOMMENDED VALVES

CHROME VALVES KIT with:

- n°2 Valves with tailpieces
- n°2 Fittings (multilayer ø 16, copper ø 12, 14)
- n°2 Chrome wall plates ø 48, hole ø 16

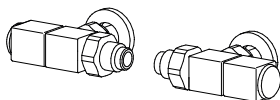

REVERSE QUADRA VALVES KIT
page 271 Art. KQR 180,10€
Extra for BREM color list 53,40€



REVERSE CYL VALVES KIT with thermostatic option,
page 273 Art. KCR 149,90€
Extra for BREM color list 53,40€

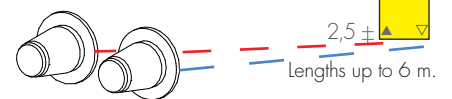

REMOTE FITTINGS Art. REM 42,10€
horizontal models tapping centres ▲▽ L- 6cm
vertical models L¹ - 6cm
DISTANT Valves page 274

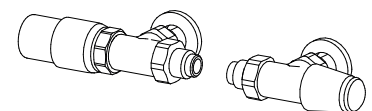

REVERSE TON VALVES KIT with THERMOSTATIC
Head page 273 Art. KTR 190,30€

CROSS GILDED/SILVER LEAF WITH OVERLAPPING SQUARES

design Luigi Brembilla

CROSS also comes in a prestigious version with a gilded-leaf or silver-leaf finish for special effects.

No more than three overlapping elements. Can be used as a towel-heater, or simply a decorative feature in any room.



CROSS FO 128-48

CROSS-FO Gilded leaf
CROSS-FA Silver leaf
Technical data and drawings
page 60 and 64

MODEL	HL cm	Gilded/Silver leaf €	EN 442 Δt 50 K watt
CROSS-F...	48-88	2151,20	394
CROSS-F...	48-128	2986,00	635
CROSS-F...	56-88	2239,40	429
CROSS-F...	56-152	3236,90	772
CROSS-F...	64-96	2429,10	480
CROSS-F...	64-168	3385,90	892
CROSS-F...	88-48	2111,00	394
CROSS-F...	88-56	2197,70	429
CROSS-F...	88-120	2284,70	617
CROSS-F...	128-48	2630,20	623
CROSS-F...	128-56	2962,80	656
CROSS-F...	152-56	3093,10	757
CROSS-F...	168-64	3209,40	875
CROSS-F...	184-48	3348,70	890
CROSS-F...	184-56	3492,50	956

Silver leaf



CROSS TRIC 152-56

CROSS BICOLOR/TRICOLOR WITH OVERLAPPING SQUARES

CROSS can be supplied in a fascinating color combination version.

No more than four overlapping elements. Painted in glossy, metallic, satin or sablé finishes, it can be used as a towel warmer or simply as a decorative element in any room.

CHOICE OF COLORS
(see Brem color list)
1 - Rear rectangle (color ...)
2 - Top or left square
3 - Bottom or right square
4 - Central square

MODEL	HL cm	BREM Colours as you like €	EN 442 Δt 50 K watt
CROSS BIC	48-88	1114,10	394
CROSS BIC	48-128	1546,20	635
CROSS BIC	56-88	1159,60	429
CROSS BIC	56-152	1676,40	772
CROSS BIC	64-96	1258,10	480
CROSS BIC	64-168	1753,50	892
CROSS BIC	88-48	1093,10	394
CROSS BIC	88-56	1138,10	429
CROSS BIC	88-120	1362,00	617
CROSS BIC	128-48	1534,30	623
CROSS BIC	128-56	1601,90	656
CROSS BIC	152-56	1661,90	757
CROSS BIC	168-64	1874,30	875
CROSS BIC	184-48	2038,40	890
CROSS BIC	184-56	2114,30	956
CROSS TRIC	48-128	1652,90	635
CROSS TRIC	56-152	1792,00	772
CROSS TRIC	64-168	1889,10	892
CROSS TRIC	128-48	1640,10	623
CROSS TRIC	128-56	1712,30	656
CROSS TRIC	152-56	1776,40	757
CROSS TRIC	168-64	2005,50	875
CROSS TRIC	184-48	2181,00	890
CROSS TRIC	184-56	2262,40	956

Technical data and drawings
page 60 and 64

CROSS CROM WITH OVERLAPPING SQUARES

design Luigi Brembilla

CROSS CROM is a chrome-plated version, for attractive compositions of no more than three overlapping elements.
Can be used as a towel-heater, or simply a decorative feature in any room.



CROSS CROM 88-120

MODEL	HL cm	Chrome-plated standard €	EN 442			▲ ▽ t.c. cm	Height H (H1) cm	Width L (L1) cm	Weight M Kg	Volume V dm ³	DUAL FUEL VERSION with E.H.E. and sleeve	
			Δt 50 K watt	Δt 40 K watt	Δt 30 K watt						Watt	€
CROSS CROM	48-88	1790,00	339	256	179	43	48 (24)	88 (48)	7,9	4,8	300	126,20
CROSS CROM	48-128	2484,90	533	402	281	99	48 (24)	128 (104)	12,8	7,7	500	129,60
CROSS CROM	56-88	1863,60	369	279	195	51	56 (32)	88 (56)	8,6	5,2	400	127,40
CROSS CROM	56-152	2693,70	648	489	342	115	56 (32)	152 (120)	15,6	9,4	650	131,80
CROSS CROM	64-96	2021,70	413	312	218	59	64 (32)	96 (64)	9,7	5,9	400	127,40
CROSS CROM	64-168	2817,40	758	572	400	131	64 (32)	168 (136)	17,6	10,7	800	136,60
CROSS CROM	88-48	1756,80	339	256	179	37	88	48 (24)	7,9	4,8	400	127,40
CROSS CROM	88-56	1828,50	369	279	195	45	88	56 (32)	8,6	5,2	400	127,40
CROSS CROM	88-120	2188,40	531	401	280	69	88	120 (56)	12,4	7,5	500	129,60
CROSS CROM	128-48	2465,20	511	386	270	37	128	48 (24)	12,8	7,7	500	129,60
CROSS CROM	128-56	2573,90	538	406	284	45	128	56 (32)	13,5	8,2	500	129,60
CROSS CROM	152-56	2670,40	621	469	328	45	152	56 (32)	15,6	9,4	650	131,80
CROSS CROM	168-64	2786,80	733	553	387	45	168	64 (32)	18,7	11,3	650	131,80
CROSS CROM	184-48	3543,90	712	538	376	37	184	48 (24)	18,7	11,3	650	121,30
CROSS CROM	184-56	3695,80	880	664	465	45	184	56 (32)	20,0	12,1	800	125,70

Drawings page 64

Thermostats p.208-209

STANDARD PRODUCTION

Chrome-plated B35 brackets and finishing
Tolerance ± 3mm - Air vent ø 1/8"
MAXIMUM OPERATING PRESSURE 4 BAR

PRODUCTION ON REQUEST

Made-to-measure dimensions
B70 brackets for 13 cm depth from wall
Electric version e.Cross Crom, page 243

STANDARD FITTING

REG ø 1/2"
On request fitting ø 3/8"
Special fittings, page 287

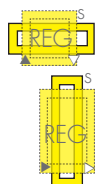

CROSS-Q TECHNICAL DRAWINGS

(for overlapping squares) TAPPING CENTRES AND FIXINGS

CrossFRAME

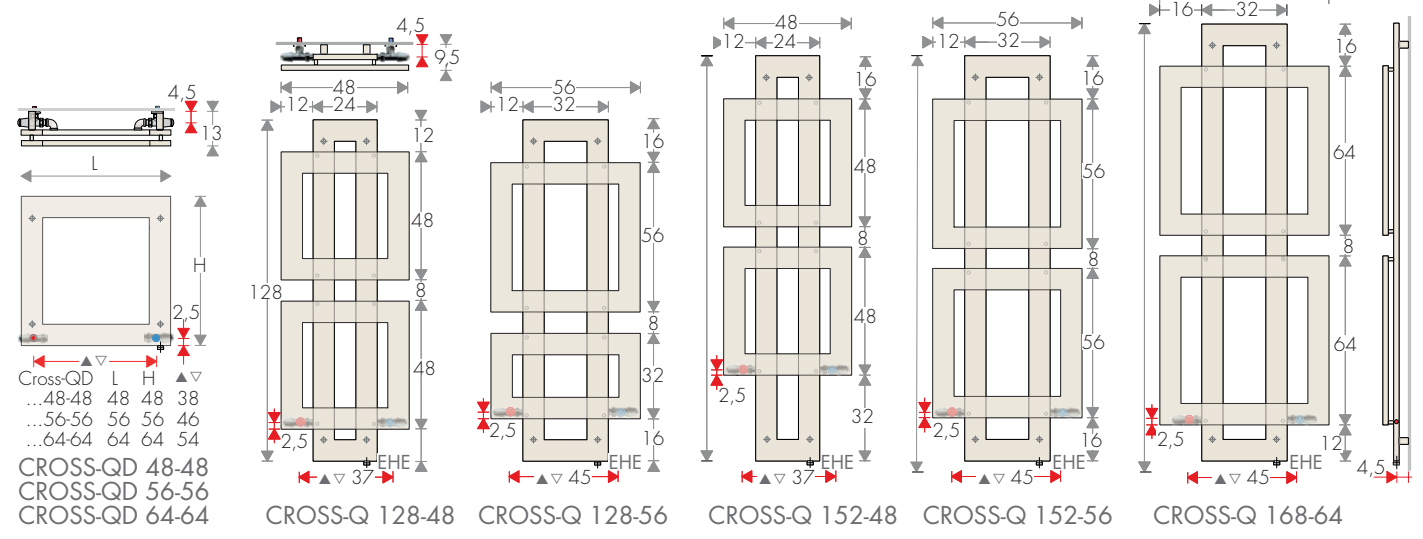
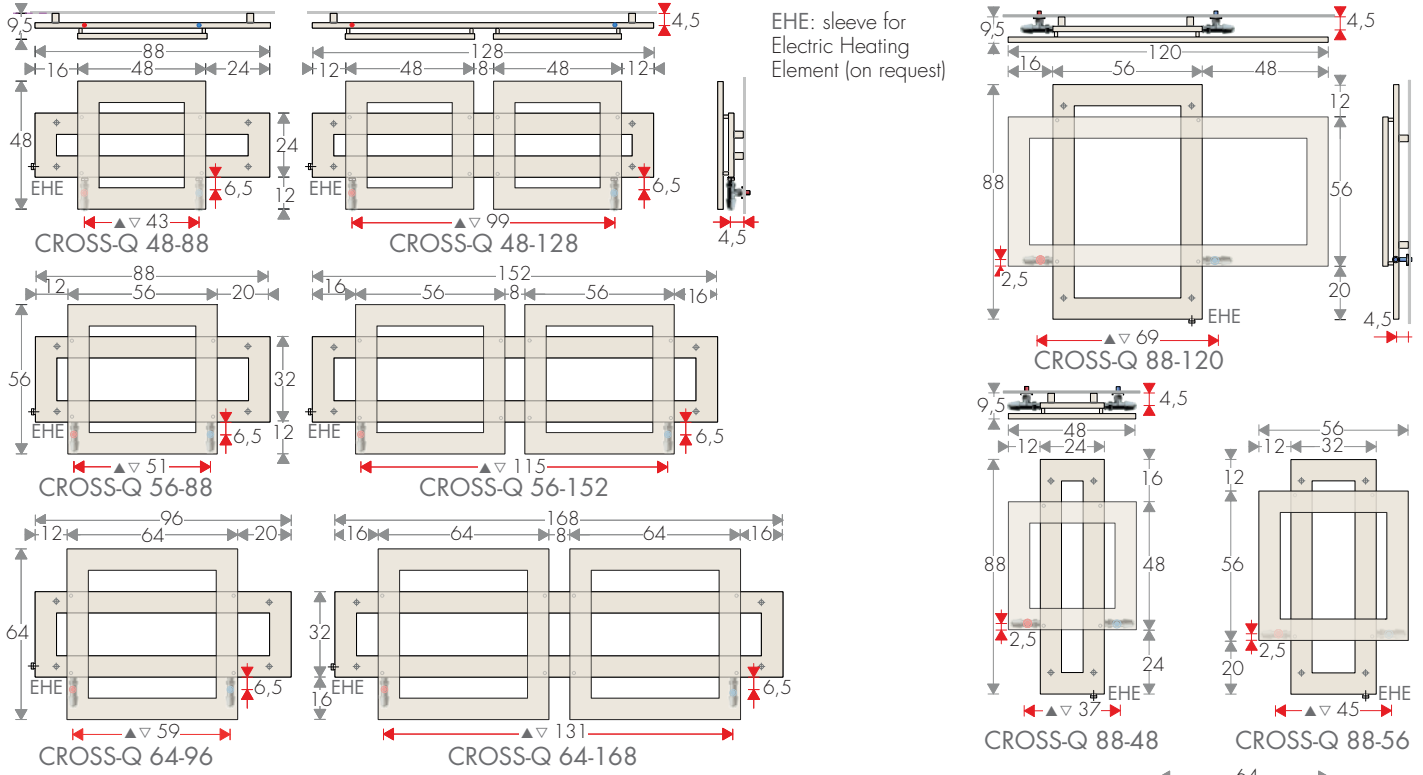

BRACKETS POSITION

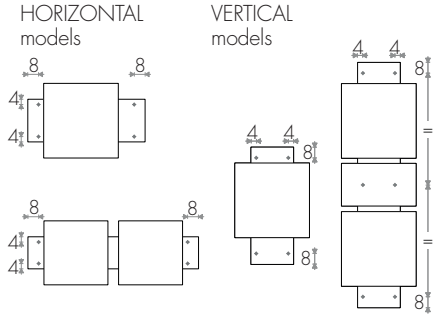

TAPPING CENTRES with REVERSE VALVES

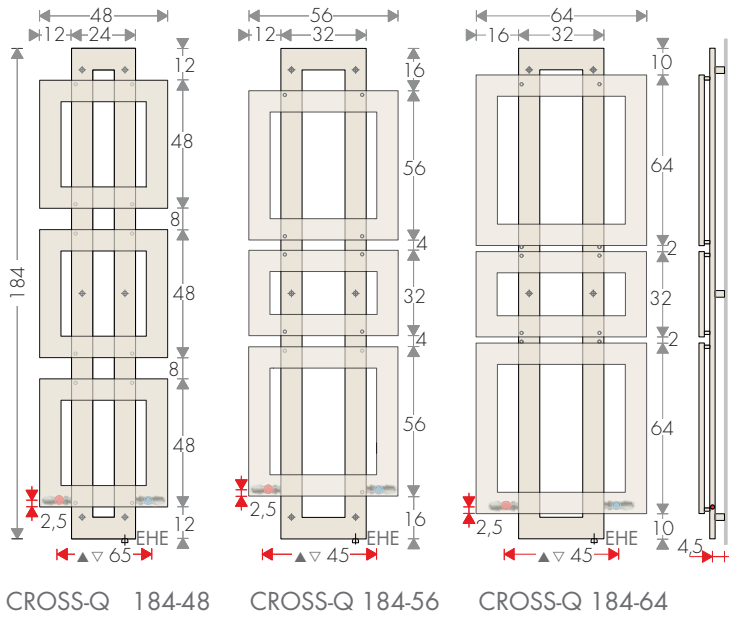

CROSS-R/RV TECHNICAL DRAWINGS

TAPPING CENTRES AND FIXINGS

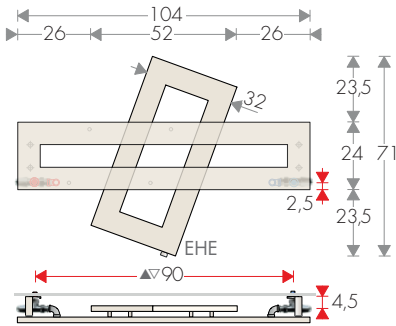

CROSS-R 70-104

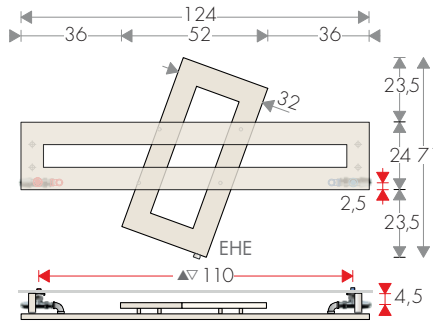

CROSS-R 70-124

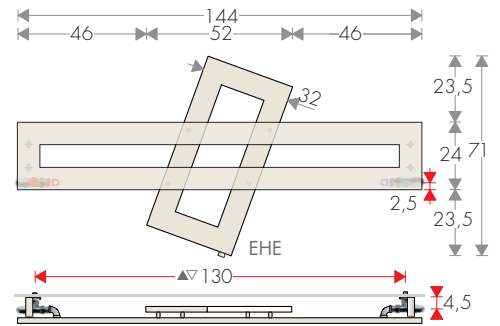

CROSS-R 70-144

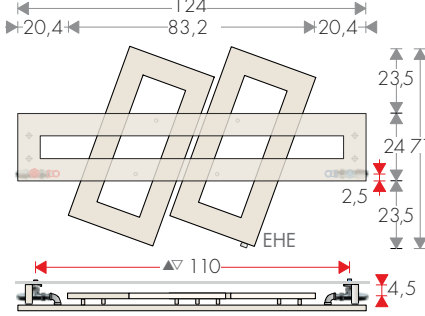

CROSS-R2 70-124

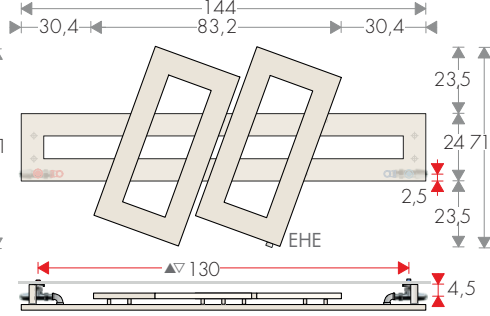

CROSS-R2 70-144

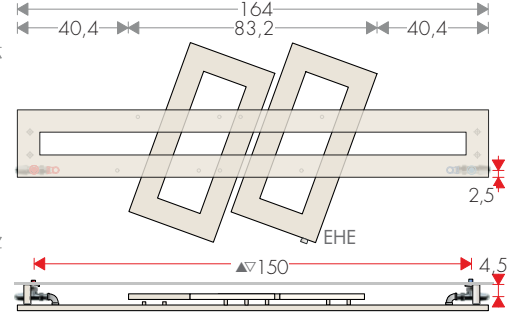

CROSS-R2 70-164

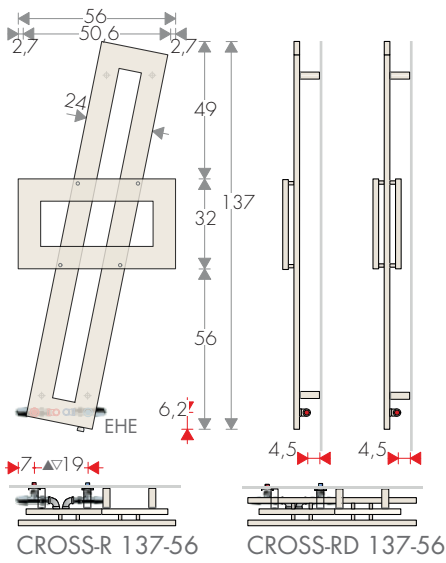

CROSS-R 137-56

CROSS-RD 137-56

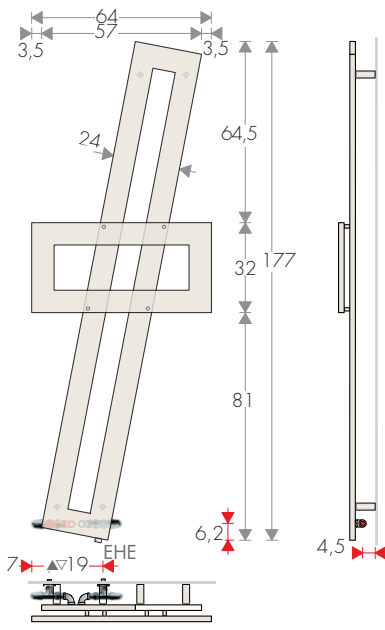

CROSS-R 177-64

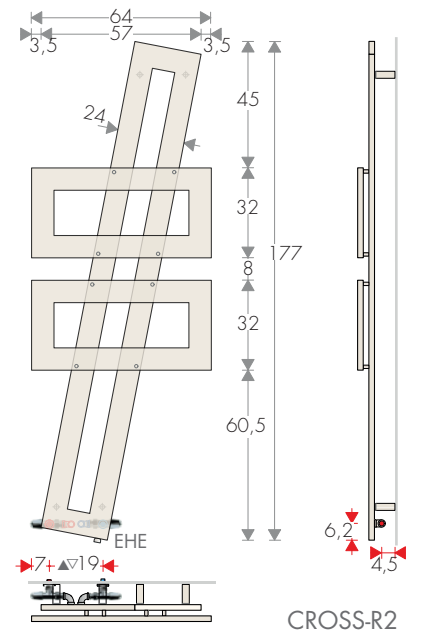

CROSS-R2 177-64

CROSS-R2 177-64

EHE: sleeve for Electric Heating Element (on request)

BRACKETS POSITION

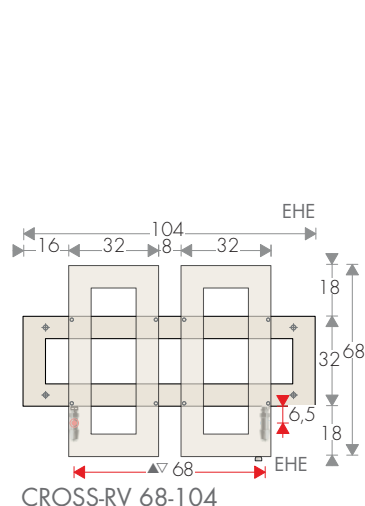
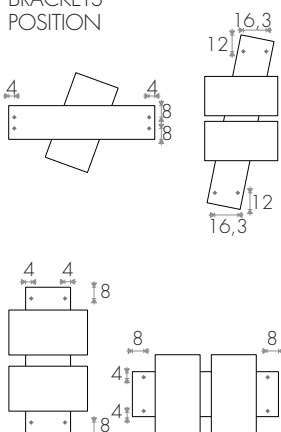

CROSS-RV 68-104

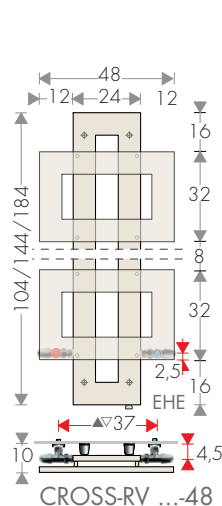

CROSS-RV ...-48

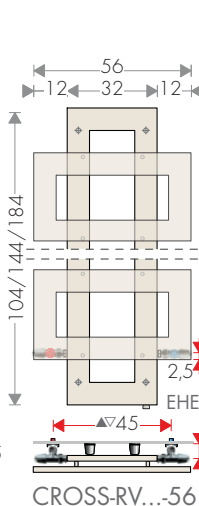

CROSS-RV ...-56

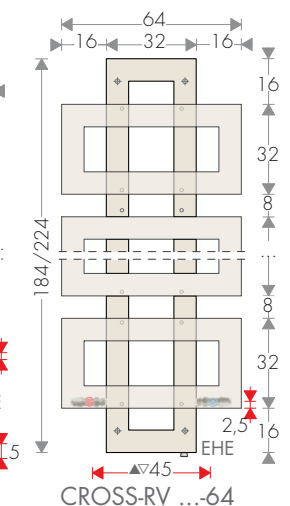

CROSS-RV ...-64

CROSS-R WITH OVERLAPPING RECTANGLES

design Luigi Brembilla

Rectangles sitting one on top of another to create a truly special radiator. CROSS-R is with side fittings on the rear rectangle, thus hiding the valves and minimizing its projection from the wall. Can be used as a towelheater, or simply a decorative feature in any room.

DIMENSIONS

Widths: 56/64/104/124/144/164 cm

Heights: 70/137/177 cm

Depths: 6 / 10 cm

Depths from wall: 14 cm

TECHNICAL DATA page 65

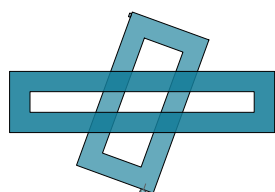
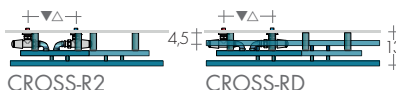

CROSS-R 70-104/124/144

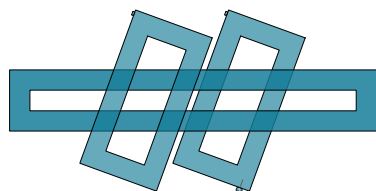

CROSS-R2 70-124/144 /164

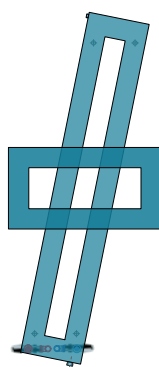

CROSS-R 137-56
CROSS-R 177-64

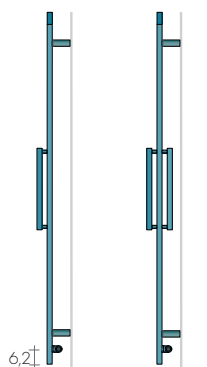

CROSS-RD
137-56

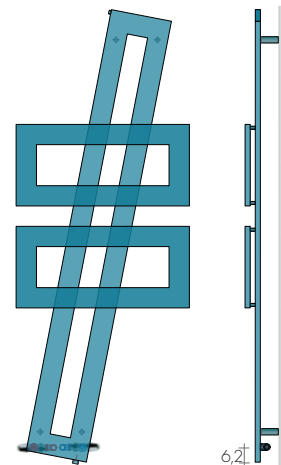

CROSS-R2 177-64

MODEL	HL cm	Standard white sablé SB9016 €	▶	Δt 50K watt	EN 442		▲ ▼ t.c. cm	Height H cm	Width L cm	Weight M Kg	Volume V dm ³	DUAL FUEL VERSION with E.H.E. and sleeve €	
					Δt 40K watt	Δt 30K watt						Watt	€
CROSS-R	70-104	829,80	▶	433	327	229	90	71	104	8,3	5	400	127,40
CROSS-R	70-124	908,10	▶	478	361	253	110	71	124	9,2	5,6	500	129,60
CROSS-R	70-144	986,40	▶	523	395	275	130	71	144	10	6,1	500	129,60
CROSS-R2	70-124	1173,20	▶	655	494	346	110	71	124	12,6	7,6	650	131,80
CROSS-R2	70-144	1259,80	▶	703	531	370	130	71	144	13,5	8,2	650	131,80
CROSS-R2	70-164	1443,70	▶	758	572	400	150	71	164	14,5	8,8	800	136,60
CROSS-R	137-56	919,30	▶	479	365	256	19	137,4	56	9,5	5,8	500	129,60
CROSS-RD	137-56	1244,00	▶	625	479	335	19	137,4	56	12,8	7,7	650	131,80
CROSS-R	177-64	1187,20	▶	585	445	312	19	177,4	64	11,6	7	650	131,80
CROSS-R2	177-64	1390,90	▶	750	574	401	19	177,4	64	15,2	9,2	800	136,60
CHROME-PLATED FINISH													
R-CROM	70-124	2179,50	▶	402	303	212	110	71	124	12,6	7,6	400	127,40
R-CROM	137-56	2262,00	▶	383	293	205	19	137,4	56	9,5	5,8	400	127,40

▶ Ready Stock

Thermostats p.208-209

STANDARD PRODUCTION

White sablé SB9016 paintwork - B70 brackets

Tolerance ± 3mm - Air vent ø 1/8"

MAXIMUM OPERATING PRESSURE 4 BAR

PRODUCTION ON REQUEST

Paintwork to Brem color list with

colored B70 brackets

Electric version e.Cross-R, page 222

+15/25%

STANDARD FITTING

REG ø 1/2"

On request fitting ø 3/8"

Special fittings page 279

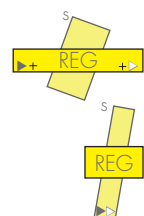

TAPPING CENTRES

Horizontal Models

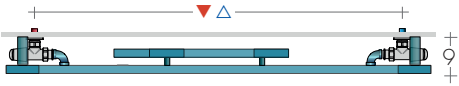
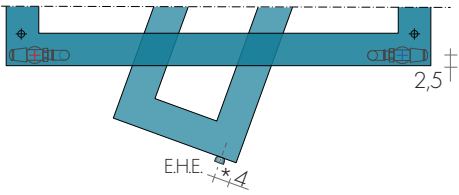

*sleeve E.H.E.
Dual Fuel version

Vertical Models

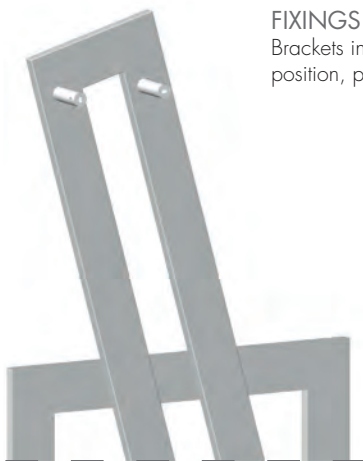
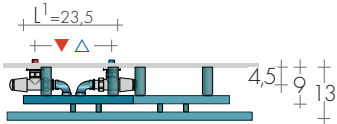
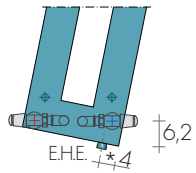

FIXINGS
Brackets included
position, page 65



R-CROM 137-56

RECOMMENDED VALVES

CHROME VALVES KIT with:

- n°2 Valves with tailpieces
- n°2 Fittings (multilayer ø 16, copper ø 12, 14)
- n°2 Chrome wall plates ø 48, hole ø 16

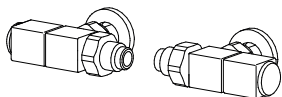

REVERSE QUADRA VALVES KIT
page 271 Art. KQR 180,10€
Extra for BREM color list 53,40€

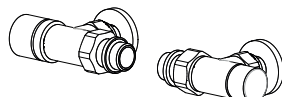

REVERSE CYL VALVES KIT with thermostatic option,
page 273 Art. KCR 149,90€
Extra for BREM color list 53,40€

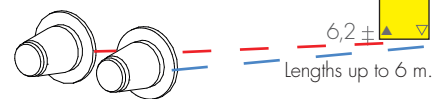

REMOTE FITTINGS Art. REM 42,10€
horizontal models tapping centres ▲▽ L- 6cm
vertical models tapping centres ▲▽ L'- 6cm
DISTANT Valves page 274

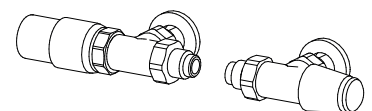

REVERSE TON VALVES KIT with THERMOSTATIC
Head page 273 Art. KTR 190,30€

CROSS-RV WITH OVERLAPPING RECTANGLES

design Luigi Brembilla

A regular pattern of rectangles sitting one on top of another to create a most linear

heating element. It can be used as a heated towel rail or a

purely decorative radiator to suit different locations of the house.

DIMENSIONS

Widths: 48/56/64/104 cm
 Heights: 68/104/144/184/208/224 cm
 Depths: 6 cm
 Depth from wall: 9,5 cm

TECHNICAL DATA page 65

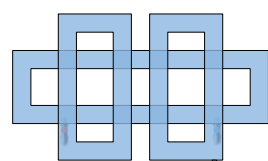

CROSS-RV 68-104

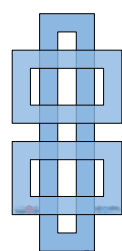
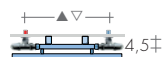

CROSS-RV 104-..

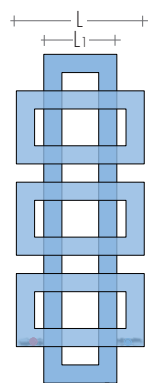

CROSS-RV 144-..

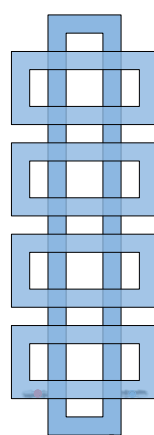

CROSS-RV 184-..

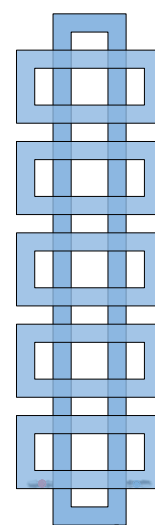

CROSS-RV 224-64
 CROSS-RV* 208-64

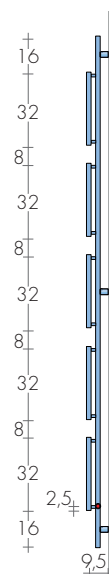

MODEL	H-L cm	Standard white sablé SB 9016 €	EN 442			▲ ▼ t.c. cm	Height H cm	Width L (L1) cm	Weight M Kg	Volume V dm ³	DUAL FUEL VERSION with E.H.E. and sleeve €	
			Δt 50K watt	Δt 40K watt	Δt 30K watt						Watt	€
CROSS-RV	68-104	1085,20	611	461	321	68	68	104 (72)	12,1	7,3	650	131,80
CROSS-RV	104-48	977,60	509	384	267	37	104	48 (24)	10,4	6,3	500	129,60
CROSS-RV	104-56	1009,20	560	422	294	45	104	56 (32)	11,4	6,9	650	121,30
CROSS-RV	144-48	1249,70	729	550	383	37	144	48 (24)	14,5	8,8	800	125,70
CROSS-RV	144-56	1289,30	797	601	419	45	144	56 (32)	15,9	9,6	800	125,70
CROSS-RV	184-48	1523,40	923	696	485	37	184	48 (24)	19,4	11,7	900	129,00
CROSS-RV	184-56	1570,90	1005	758	528	45	184	56 (32)	21,1	12,8	900	129,00
CROSS-RV	184-64	1612,00	1071	808	563	45	184	64 (32)	22,5	13,6	1200	136,70
CROSS-RV	224-64	1700,40	1293	975	679	45	224	64 (32)	28,1	16,9	1200	136,70
CROSS-RV*	208-64	1652,40	1261	951	662	45	208	64 (32)	28,1	16,9	1200	136,70

*Distance between rectangles 4 cm

OTHER DIMENSIONS on request

Thermostats p.208-209

STANDARD PRODUCTION

White sablé SB9016 paintwork - B35 brackets
 Tolerance ± 3mm - Air vent ø 1/8"
 MAXIMUM OPERATING PRESSURE 4 BAR

PRODUCTION ON REQUEST

Paintwork to Brem color list with
 colored B35 brackets
 Electric version, on request

+15/25%

STANDARD FITTING

REG ø 1/2"
 Fittings ø 3/8", on request
 Special fittings, page 279

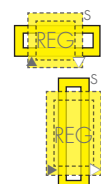

TAPPING CENTRES

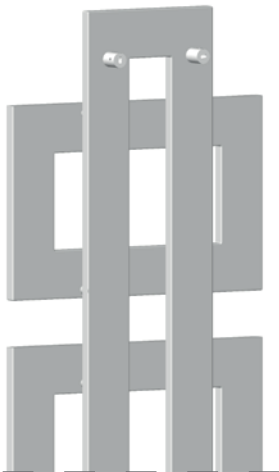
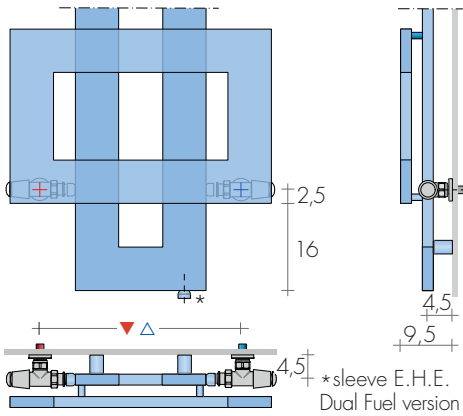

FIXINGS
Brackets included
position page 65

CROSS-RV 184-56

RECOMMENDED VALVES

CHROME VALVES KIT with:

- n°2 Valves with tailpieces
- n°2 Fittings (multilayer ø 16, copper ø 12, 14)
- n°2 Chrome wall plates ø 48, hole ø 16

SPECIAL FINISHES: Gold, Bronze, brushed Nickel, gilden/silver leaf for 2 valves page 267
Brushed Nickel FITTING KIT extra Art. RN 30,50€

REMOTE FITTINGS Art. REM 42,10€
horizontal models tapping centres ▲▼ L- 6cm
vertical models ▲▼ L¹ - 6cm
DISTANT Valves page 274

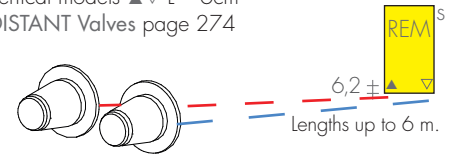

REVERSE QUADRA VALVES KIT
page 271 Art. KQR 180,10€
Extra for BREM color list 53,40€

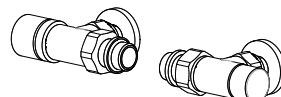

REVERSE CYL VALVES KIT with thermostatic option,
page 273 Art. KCR 149,90€
Extra for BREM color list 53,40€

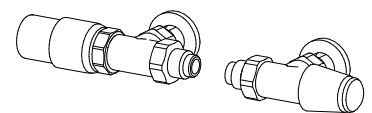

REVERSE TON VALVES KIT with THERMOSTATIC
Head page 273 Art. KTR 190,30€

ESSEN

design Luigi Brembilla

ESSEN: a simple geometry forms a towel heater composed by one single kind of

tube, to give an intriguing aesthetics and high performances. A big frame which has

a rectangular section takes place of usual manifolds and avoids high heating outputs.

DIMENSIONS

Widths: 40 / 52 / 64 / 126 cm

Heights: 72 / 104 / 136 / 168 / 200 cm

Depths: 2 cm. Essen Plus 8,5 cm

Depths from wall: 9 cm. Essen Plus 10 cm

ESSEN PLUS with radiating tubes at the rear

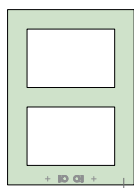

ESSEN 72-..

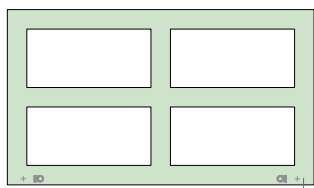

ESSEN 72-126

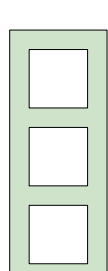

ESSEN 104-..

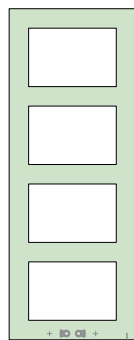

ESSEN 136-..

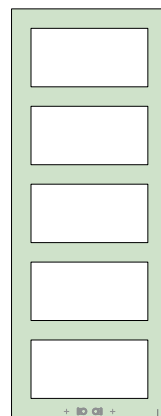

ESSEN 168-..

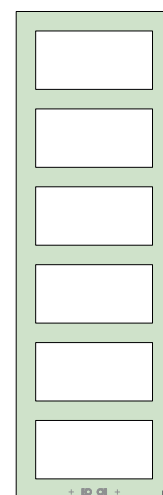

ESSEN 200-..

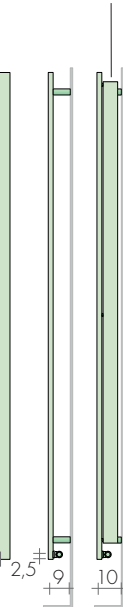

MODEL	H-L cm	Standard white sablé SB9016 €	EN442			▲ ▽ t.c. cm	Height H cm	Width L cm	Weight M Kg	Volume V dm ³	DUAL FUEL VERSION with E.H.E. and sleeve	
			Δt 50 K watt	Δt 40 K watt	Δt 30 K watt						Watt	€
ESSEN	72-40	632,10	238	180	125	19	72	40	4,7	2,8	250	125,10
ESSEN	72-52	657,70	277	209	146	19	72	52	5,4	3,3	300	126,20
ESSEN PLUS	72-52	822,10	420	319	221	19	72	52	8,9	5,5	400	127,40
ESSEN	72-126	943,30	575	439	303	112	72	126	11,3	6,8	650	131,80
ESSEN	104-52	730,50	387	292	204	19	104	52	7,6	4,6	400	127,40
ESSEN PLUS	104-40	828,00	519	332	274	19	104	40	11,1	6,8	500	129,60
ESSEN	136-40	787,90	431	325	227	19	136	40	8,5	5,1	400	127,40
ESSEN	136-52	822,50	497	375	262	19	136	52	9,8	5,9	500	129,60
ESSEN PLUS	136-40	1069,20	668	504	352	19	136	40	14,2	8,8	650	131,80
ESSEN PLUS	136-52	1183,50	743	571	392	19	136	52	15,8	9,7	800	136,60
ESSEN PLUS	136-64	1202,40	819	625	432	19	136	64	17,3	10,7	800	136,60
ESSEN	168-40	930,30	528	399	278	19	168	40	10,4	6,3	500	129,60
ESSEN	168-52	972,40	607	458	320	19	168	52	11,9	7,2	650	131,80
ESSEN	168-64	992,90	686	518	362	19	168	64	13,5	8,2	650	131,80
ESSEN PLUS	168-40	1202,70	816	518	430	19	168	40	17,4	10,7	800	136,60
ESSEN PLUS	168-52	1312,50	905	616	477	19	168	52	19,2	11,8	900	140,20
ESSEN	200-40	1082,50	625	701	329	19	200	40	12,3	7,4	650	131,80
ESSEN	200-64	1127,50	810	472	427	19	200	64	15,9	9,6	800	136,60
CHROME-PLATED FINISH												
ESSEN CROM	104-52	1606,40	333	251	175	19	104	52	7,6	4,6	300	126,20
ESSEN CROM	136-52	1928,80	427	322	225	19	136	52	9,8	5,9	400	127,40
ESSEN CROM	168-52	2138,60	522	394	275	19	168	52	11,9	7,2	500	129,60
ESSEN CROM	168-64	2184,30	590	445	311	19	168	64	13,5	8,2	650	131,80

GILDEN/SILVER LEAF FINISHES

Extra: the standard price x 1,05

▶ Ready Stock

Thermostats p.208-209

STANDARD PRODUCTION

White sablé SB9016 paintwork - Brackets B..

Tolerance ± 3mm - Air vent ø 1/8"

MAXIMUM OPERATING PRESSURE 4 BAR

PRODUCTION ON REQUEST

Paintwork to Brem color list with colored

brackets

Electric version e.Essen, page 225

STANDARD FITTING REG ø 1/2"

On request: ESSEN with depth 5,5

cm and fitting EG ø3/8"

Special fittings page 279



TAPPING CENTRES

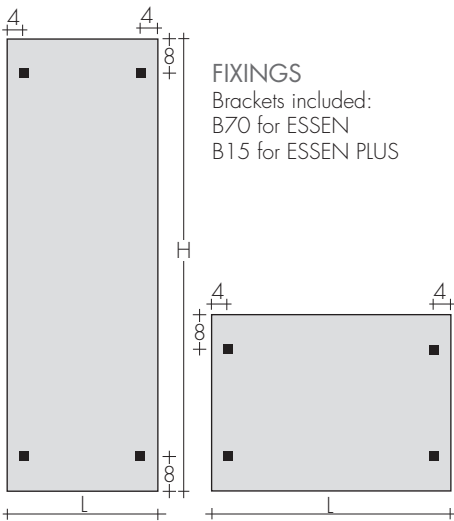
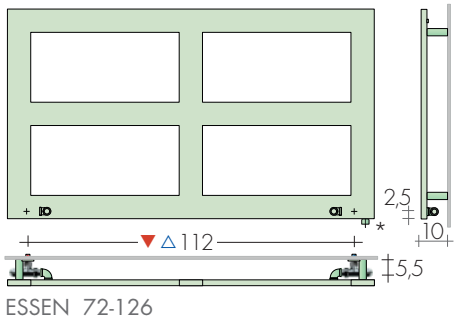
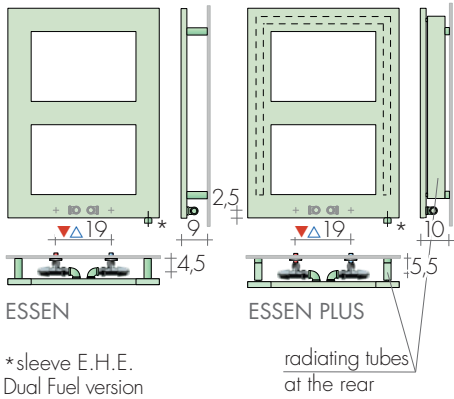

CrossFRAME

RECOMMENDED VALVES

- CHROME VALVES KIT with:
- n°2 Valves with tailpieces
 - n°2 Fittings (multilayer ø 16, copper ø 12, 14)
 - n°2 Chrome wall plates ø 48, hole ø 16

SPECIAL FINISHES: Gold, Bronze, brushed Nickel, gilden/silver Leaf for 2 valves page 267
Brushed Nickel FITTING KIT extra Art. RN 30,50€

REMOTE FITTINGS Art. REM 42,10€
Tapping centres: at the rear of radiator ▲▽ L - 6 cm
DISTANT Valves page 274

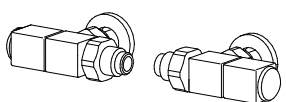
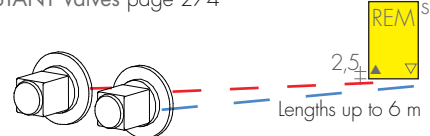

REVERSE QUADRA VALVES KIT
page 271 Art. KQR 180,10€
Extra for BREM color list 53,40€

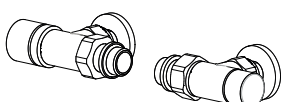

REVERSE CYL VALVES KIT with thermostatic option,
page 273 Art. KCR 149,90€
Extra for BREM color list 53,40€

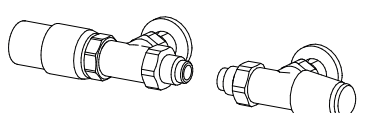

REVERSE TON VALVES KIT with THERMOSTATIC
Head page 273 Art. KTR 190,30€

FIT

FIT: a simple geometry forms a towel heater composed by one single kind of tube, to

give an intriguing aesthetics and high performances. A big frame which has a

design Luigi Brembilla rectangular section takes place of usual manifolds and defines an alternative design.

DIMENSIONS

Widths: 28 / 40 / 48 / 56 / 64 cm

Heights: 88 / 108 / 128 / 148 / 168 / 188 cm

Depths: 2 cm

Depths from wall: 9 cm

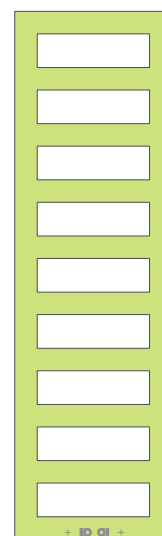
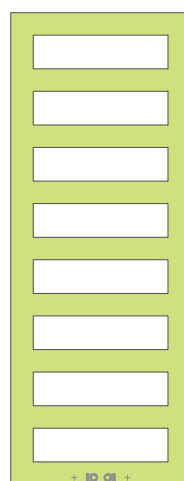
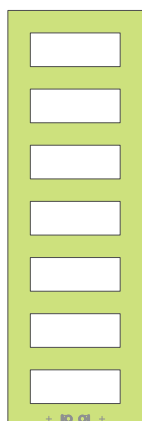
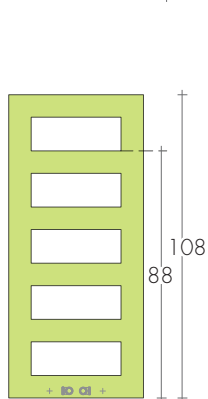
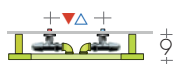

FIT 88-48
FIT 108-48

FIT 128-..

FIT 148-48

FIT 168-28

FIT 168-..

FIT 188-56

MODEL	H/L cm	Blanc standard sablé SB9016 €	EN442			▲▼ t.c. cm	Height H cm	Width L cm	Weight M Kg	Volume V dm ³	DUAL FUEL VERSION with E.H.E. and sleeve	
			Δt 50K watt	Δt 40K watt	Δt 30K watt						Watt	€
FIT	88-48	704,30	393	296	206	19	88	48	7,3	4,4	400	127,40
FIT	108-48	747,90	477	359	249	19	108	48	8,8	5,3	500	129,60
FIT	128-40	777,70	496	373	259	19	128	40	9,2	5,6	500	129,60
FIT	128-56	877,90	627	472	328	19	128	56	11,6	7,0	650	131,80
FIT	148-48	904,40	646	486	338	19	148	48	11,9	7,2	650	131,80
FIT	168-28	909,40	519	391	271	19	168	28	9,6	5,8	500	129,60
FIT	168-40	940,60	646	486	338	19	168	40	11,9	7,2	650	131,80
FIT	168-56	1002,80	814	613	426	19	168	56	15,0	9,1	800	136,60
FIT	168-64	1017,00	899	677	470	19	168	64	16,6	10,1	900	140,20
FIT	188-56	1067,80	908	684	475	19	188	56	16,8	10,2	900	140,20

GILDEN/SILVER LEAF FINISHES

Extra: the standard price x 1,05

Thermostats p.208-209

STANDARD PRODUCTION

White sablé SB9016 paintwork, brackets B70
Tolerance ± 3mm - Air vent ø 1/8"

MAXIMUM OPERATING PRESSURE 4 BAR

PRODUCTION ON REQUEST

Paintwork to Brem color list with
colored B70 brackets

Electric version e.Fit, page 226

+15/25%

STANDARD FITTING REG ø 1/2"

On request: FIT with depth 5,5 cm
and fitting EG ø3/8"

Special fittings page 279



TAPPING CENTRES

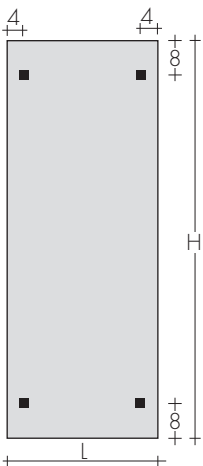
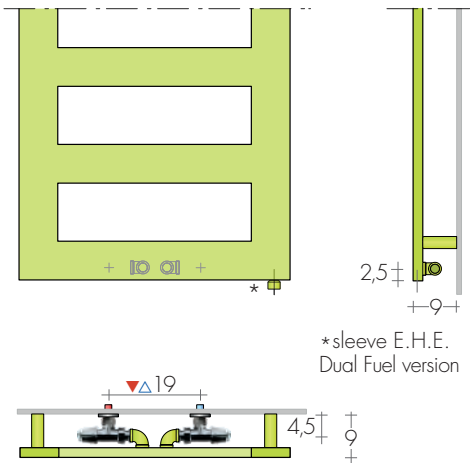

FIXINGS
B70 brackets included.



CrossFRAME

RECOMMENDED VALVES

CHROME VALVES KIT with:

- n°2 Valves with tailpieces
- n°2 Fittings (multilayer ø 16, copper ø 12, 14)
- n°2 Chrome wall plates ø 48, hole ø 16

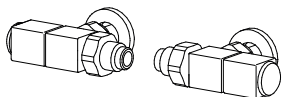

REVERSE QUADRA VALVES KIT
page 271 Art. KQR 180,10€
Extra for BREM color list 53,40€

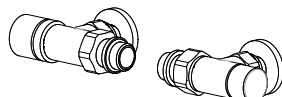

REVERSE CYL VALVES KIT with thermostatic option,
page 273 Art. KCR 149,90€
Extra for BREM color list 53,40€

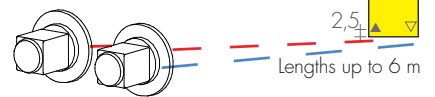

REMOTE FITTINGS Art. REM 42,10€
Tapping centres: at the rear of radiator ▲▼ L - 6 cm
DISTANT Valves page 274

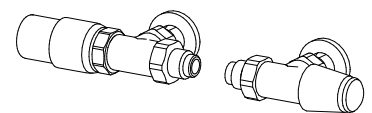

REVERSE TON VALVES KIT with THERMOSTATIC
Head page 273 Art. KTR 190,30€

FREE

design Luigi Brembilla

FREE is a rectangular tube heating towel bar that can be fixed at will to the wall.

Free towel heater can be used on its own or combined with models protruding max 6 cm

from wall (E.g. Clak, Egon, Form, Cross-V, Cross-G).

DIMENSIONS

Widths: 54/64/84/104/124/144/164 cm

Heights: 24 cm

Depths: 12cm



CrossFRAME

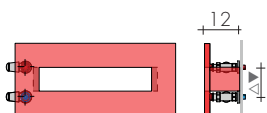

FREE 24-54

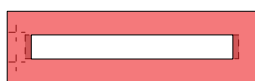

FREE 24-84



FREE 24-124



FREE 24-64



FREE 24-104



FREE 24-144 / 24-164

MODEL	H/L cm	Standard white sablé SB9016 €	EN 442			▲▼ t.c. cm	Height H cm	Width L cm	Weight M Kg	Volume V dm ³	DUAL FUEL VERSION with E.H.E. and sleeve	
			Δt 50K watt	Δt 40K watt	Δt 30K watt						Watt	€
FREE	24-54	333,00	130	95	68	10	24	54	2,6	1,7	-	-
FREE	24-64	351,70	158	119	83	10	24	64	3,0	1,9	-	-
FREE	24-84	392,20	202	153	106	10	24	84	3,9	2,4	250	125,10
FREE	24-104	432,80	246	186	129	10	24	104	4,7	2,9	250	125,10
FREE	24-124	473,30	290	219	153	10	24	124	5,5	3,5	300	126,20
FREE	24-144	514,00	334	252	176	10	24	144	6,4	4,0	300	126,20
FREE	24-164	554,70	378	285	199	10	24	164	7,3	4,5	400	127,40

Custom lengths available on request ▶ Ready Stock

Thermostats p.208-209

ELECTRIC/MIXED Version
HEATING ELEMENT POSITION
Horizontal Heating Element in (D)
E.H.E. left side on request



STANDARD PRODUCTION

White sablé SB9016 paintwork with brackets
Tolerance ± 3mm - Air vent ø 1/8"

MAXIMUM OPERATING PRESSURE 4 BAR

PRODUCTION ON REQUEST

Brem paintwork - colored brackets +15/25%

Other dimensions on request

Electric version e.Free, page 229

STANDARD FITTING

AC ø 1/2"

On request fitting ø 3/8"

Special fittings, page 279



TAPPING CENTRES

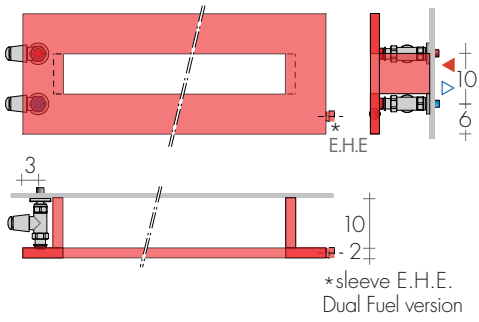

On request, connections on the right or customized.

FIXINGS

Brackets included

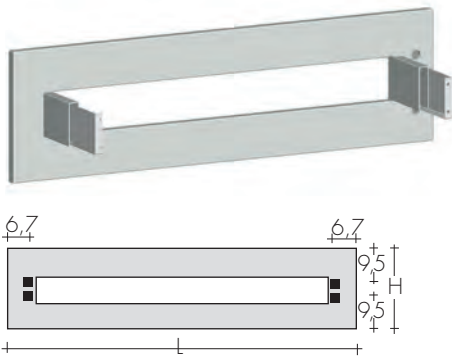

RECOMMENDED VALVES

CHROME VALVES KIT with:

- n°2 Valves with tailpieces
- n°2 Fittings (multilayer $\phi 16$, copper $\phi 12, 14$)
- n°2 Chrome wall plates $\phi 48$, hole $\phi 16$

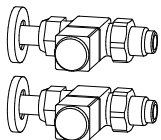

KIT STRAIGHT VALVES QUADRA
page 271 Art. KQD 190,00€
Extra for BREM color list 53,40€

SPECIAL FINISHES: Gold, Bronze, brushed Nickel,
gilden/silver Leaf for 2 valves page 267
Brushed Nickel FITTING KIT extra Art. RN 30,50€

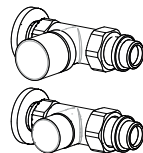

KIT STRAIGHT VALVES CYL with thermostatic
option, pag.273 Art. KCD 158,80€
Extra for BREM color list 53,40€

REMOTE FITTINGS Art. REM 42,10€
Tapping centres: at the rear AC $\triangle \nabla 10\text{cm}$
DISTANT Valves page 274

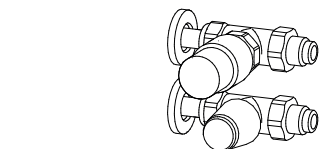
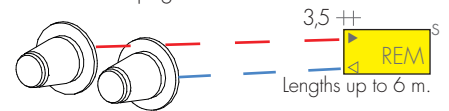

KIT STRAIGHT VALVES TON with THERMOSTATIC
Head, p. 269 Art. KTD 202,40€



KORE PLUS

design Luigi Brembilla

KORE PLUS an elegant and essential frame, added by a profile on the back to enhance

the thermal yields. Standard vertical models are further embellished with radiant tubes to

house the wipes. An impressive and unusual interior décor effect.

DIMENSIONS

Width 54 / 124 cm
 Height 55 / 98 / 140 / 180 cm
 Depth 8 cm
 Depth from wall 9,5 cm

CrossFRAME

KORE-P with radiating tubes at the rear

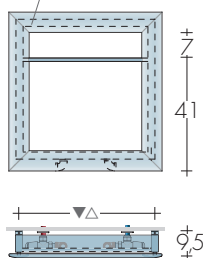

KORE-P 55 - 54

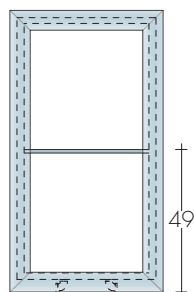

KORE-P 98 - 54

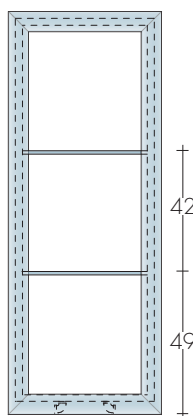

KORE-P 140 - 54

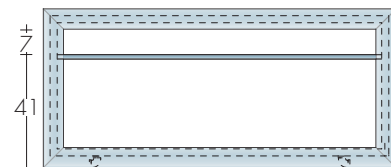

KORE-P 55 - 124

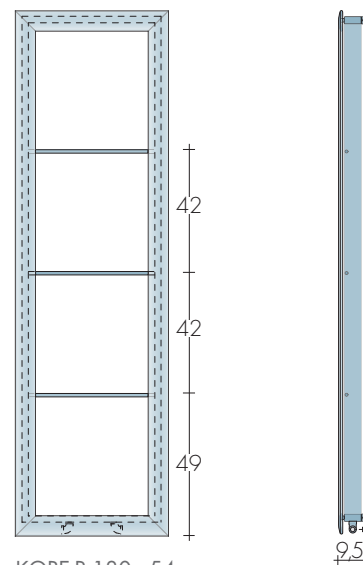

KORE-P 180 - 54

MODELE	H/L cm	Standard white sablé SB 9016 €	Δt 50K watt	EN 442 Δt 40K watt	Δt 30K watt	▲ ▼ t.c. cm	Height H cm	Width L cm	Weight M Kg	Volume V dm ³	DUAL FUEL VERSION with E.H.E. and sleeve VV €	
KORE-P	55-124	658,80	464	349	243	100	55	124	11,7	5,6	500	129,60
KORE-P	55-54	493,20	266	200	139	30	55	54	6,7	3,2	300	126,20
KORE-P	98-54	567,70	388	292	203	30	98	54	9,8	4,6	400	127,40
KORE-P	140-54	687,10	507	382	265	30	140	54	12,8	6,1	500	129,60
KORE-P	180-54	738,90	621	468	325	30	180	54	15,7	7,4	650	131,80

*Dual fuel valve or T to be added p.207
 Thermostats p.208-209

MINIMUM OPERATING PRESSURE 1,5 BAR

STANDARD PRODUCTION

White sablé SB9016 paintwork, white brackets
 B15 - Tolerance ± 3 mm - Air vent ø 1/8"
 MAXIMUM OPERATING PRESSURE 3 BAR

PRODUCTION ON REQUEST

Paint to Brem color list with colored B15
 brackets +15/25%
 Electric version e.Kore Plus, p. 237

STANDARD FITTING

REG ø 1/2"
 On request fitting ø 3/8"
 Special fittings page 279



TAPPING CENTRES

KORE PLUS: fittings with reverse valves $\varnothing 1/2"$

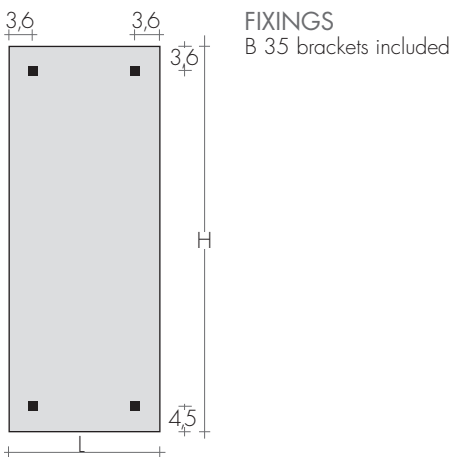
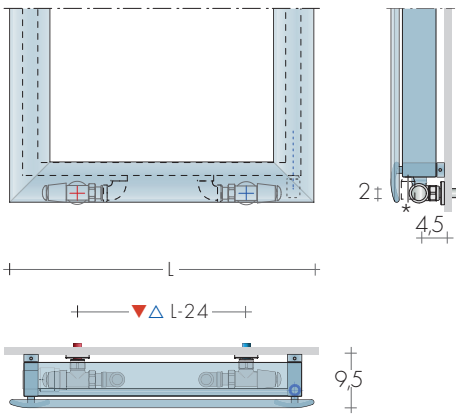

KORE-P 140-54

RECOMMENDED VALVES

CHROME VALVES KIT with:

- n°2 Valves with tailpieces
- n°2 Fittings (multilayer $\varnothing 16$, copper $\varnothing 12, 14$)
- n°2 Chrome wall plates $\varnothing 48$, hole $\varnothing 16$

SPECIAL FINISHES

page 267

Finishes Gold, Bronze, Brushed Nickel for 2 valves

Brushed Nickel FITTING KIT extra Art. RN 30,50€

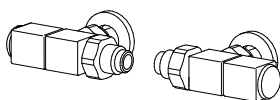

REVERSE QUADRA VALVES KIT
page 271 Art. KQR

180,10€
53,40€

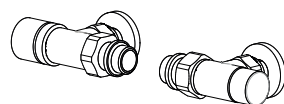

REVERSE CYL VALVES KIT with thermostatic option,
page 273 Art. KCR 149,90€

Extra for BREM color list

53,40€

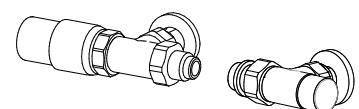

REVERSE CYL VALVES KIT with THERMOSTATIC
Head page 273, 266 Art. KTR 183,40€

Extra for BREM color list

53,40€

PIT

design Pietro Facheris

PIT towel heater has an elegant minimalist design, with two or three radiant rectangles,

overlapping each other. Space is optimized by multiplying the heat

output and rectangular sections create three different points of support for towels.

DIMENSIONS:

Width: 32/40/48/56/126 cm
 Height: 60/72/99/132/176 cm
 Depth: 4,5 / 8 cm
 Depths from wall: 11,5 cm

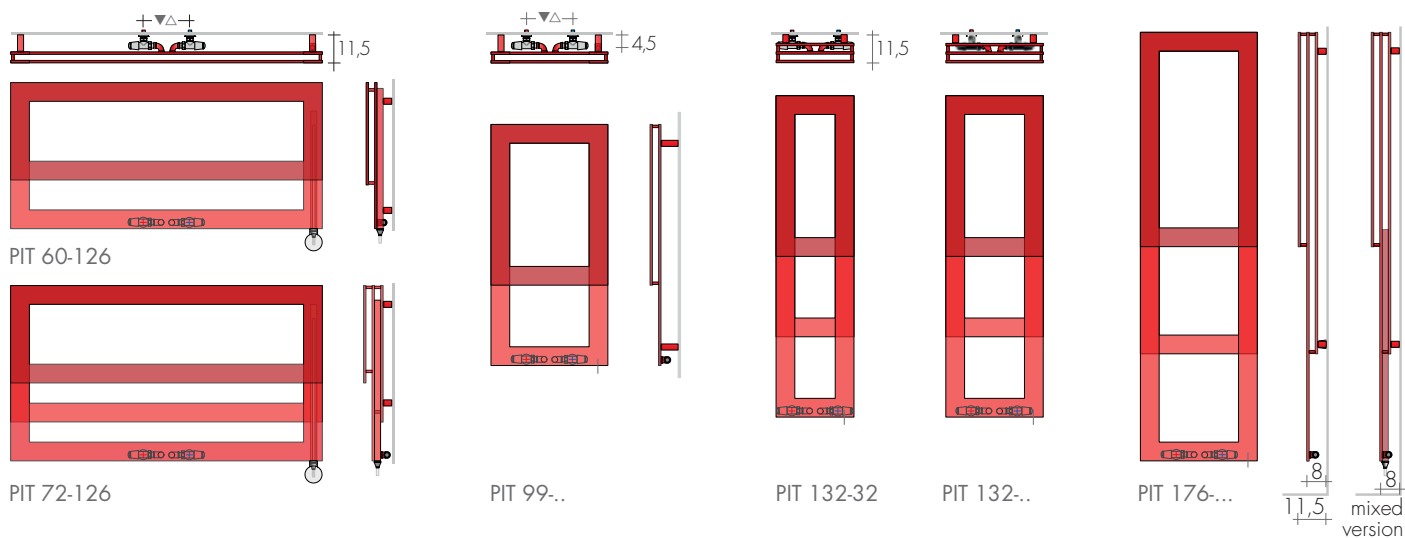

MODEL	HxL cm	Standard white sablé SB9016 €	Δt 50K watt	EN442 Δt 40K watt	Δt 30K watt	▲▼ t.c. cm	Height H cm	Width L cm	Weight M Kg	Volume V dm ³	DUAL FUEL VERSION with E.H.E. and sleeve	
											Watt	€
PIT	60-126	989,30	588	444	310	19	60	126	11,7	3,5	650	213,10
PIT	72-126	1209,80	900	680	474	19	72	126	17,8	5,5	900	221,50
PIT	99-40	688,80	369	279	194	19	99	40	7,7	2,3	400	208,70
PIT	99-48	745,40	403	304	212	19	99	48	8,3	2,5	400	208,70
PIT	132-32	981,10	567	428	298	19	132	32	12,3	3,7	500	210,90
PIT	132-40	1015,40	613	463	323	19	132	40	13,2	4,0	650	213,10
PIT	132-48	1049,40	660	498	347	19	132	48	14,0	4,2	650	213,10
PIT	176-32	1133,30	750	566	395	19	176	32	16,0	4,8	800	217,90
PIT	176-40	1167,50	796	601	419	19	176	40	16,9	5,1	800	217,90
PIT	176-48	1201,80	843	636	444	19	176	48	17,8	5,3	900	221,50
PIT	176-56	1239,80	889	671	468	19	176	56	18,6	5,6	900	221,50

► Ready in stock

Thermostats p.208-209

STANDARD PRODUCTION

White sablé SB 9016 paintwork - Brackets B..
 Tolerance ± 3mm - Air vent ø 1/8"
 MAXIMUM OPERATING PRESSURE 4 BAR

PRODUCTION ON REQUEST

Paintwork to Brem color list with
 colored B.. brackets
 Electric version e.Pit, page 248

+15/25%

STANDARD FITTING

REG ø 1/2"

Special fittings, page 279



TAPPING CENTRES

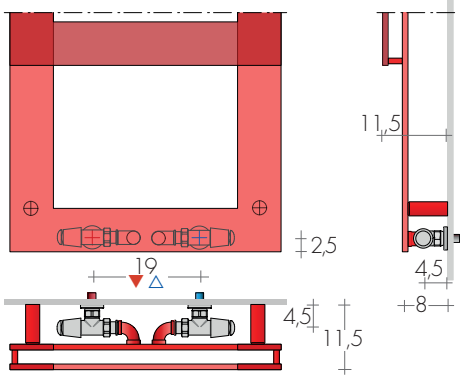

*MIXED VERSIONS vertical models only with EG ▲▽ 5cm fittings and angled valves

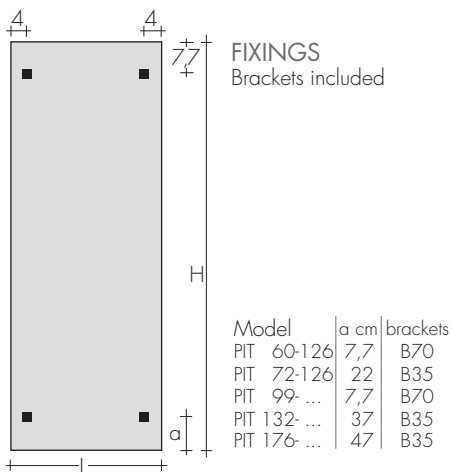
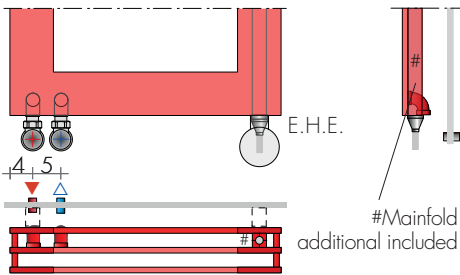

RECOMMENDED VALVES

CHROME VALVES KIT with:

- n°2 Valves with tailpieces
- n°2 Fittings (multilayer ø 16, copper ø 12, 14)
- n°2 Chrome wall plates ø 48, hole ø 16

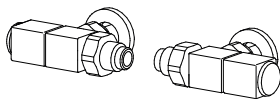

REVERSE QUADRA VALVES KIT
page 271 Art. KQR
Extra for BREM color list

180,10€
53,40€



REVERSE CYL VALVES KIT with thermostatic option,
page 273 Art. KCR 149,90€
Extra for BREM color list

149,90€
53,40€

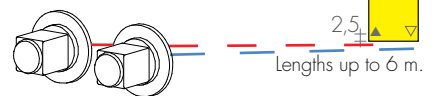

SPECIAL FINISHES page 267
Finishes Gold, Bronze, Brushed Nickel for 2 valves
Brushed Nickel FITTING KIT extra Art. RN 30,50€

REMOTE FITTINGS Art. REM 42,10€
Tapping centres: at the rear of radiator ▲▽ L - 6cm
DISTANT Valves page 274

REVERSE TON VALVES KIT with THERMOSTATIC
Head page 273 Art. KTR 190,30€

QUAR

design Luigi Brembilla

QUAR: an original heated towel rail with a pure geometrical expression.

In QUAR, the tube is square, not round. A large rectangular section frame replaces

the usual manifolds while increasing heat output at the same time.

DIMENSIONS

Width: 30,5 / 38,5 / 46,5 / 54,5 / 62,5 cm

Height: 97,5 / 127,5 / 157,5 / 180 cm

Depth: 2 cm / Quar-P 8,5 cm

Depth from wall : 9 cm / Quar-P 10 cm

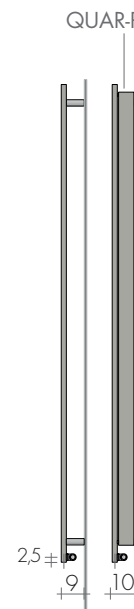
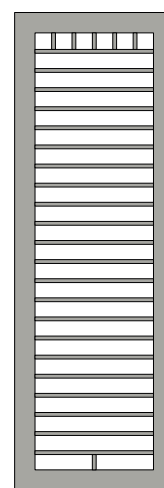
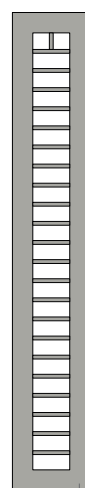
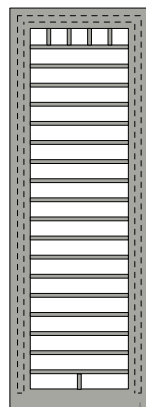
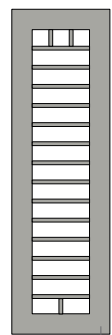
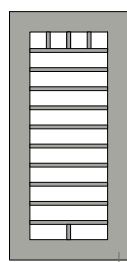
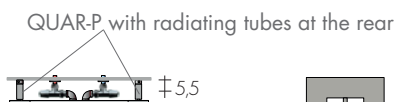
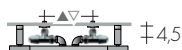

QUAR 97-..

QUAR 127-..

QUAR.. 157-..

QUAR.. 180-30

QUAR.. 180-..

MODEL	H-L cm	Standard white sablé SB9016 €	EN442			▲ ▽ t.c. cm	Height H cm	Width L cm	Weight M Kg	Volume V dm ³	DUAL FUEL VERSION with E.H.E. and sleeve	
			Δt 50 K watt	Δt 40 K watt	Δt 30 K watt						Watt	€
QUAR	97-46	868,10	364	276	193	19	97,5	46,5	6,7	3,9	400	127,40
QUAR	97-54	884,70	403	306	214	19	97,5	54,5	7,4	4,2	400	127,40
QUAR	127-38	917,50	415	315	220	19	127,5	38,5	7,7	4,5	400	127,40
QUAR	127-46	936,50	463	351	245	19	127,5	46,5	8,5	4,9	500	129,60
QUAR	127-54	954,90	510	387	270	19	127,5	54,5	9,4	5,3	500	129,60
QUAR	157-38	1018,00	506	384	268	19	157,5	38,5	9,4	5,4	500	129,60
QUAR	157-54	1060,90	617	468	327	19	157,5	54,5	11,3	6,3	650	131,80
QUAR	157-62	1082,90	673	511	357	19	157,5	62,5	12,3	6,8	650	131,80
QUAR-P	157-46	1296,00	832	631	441	19	157,5	46,5	17,0	10,1	800	136,60
QUAR-P	157-54	1318,00	895	679	474	19	157,5	54,5	18,1	10,6	900	140,20
QUAR	180-30	1109,40	512	389	271	19	180	30,5	9,6	5,6	500	129,60
QUAR	180-46	1156,50	637	483	338	19	180	46,5	11,7	6,6	650	131,80
QUAR	180-54	1180,50	699	531	370	19	180	54,5	12,8	7,1	650	131,80
QUAR	180-62	1204,60	761	578	403	19	180	62,5	13,9	7,6	800	136,60
QUAR-P	180-30	1366,60	808	613	428	19	180	30,5	16,8	10,2	800	125,70
QUAR-P	180-38	1388,70	877	666	465	19	180	38,5	18,1	10,8	900	129,00
QUAR-P	180-62	1461,80	1091	828	578	19	180	62,5	22,0	12,7	1200	136,70

Thermostats p.208-209

STANDARD PRODUCTION

White sablé SB9016 paintwork white brackets
Tolerance ± 3mm - Air vent ø 1/8"

MAXIMUM OPERATING PRESSURE 4 BAR

PRODUCTION ON REQUEST

Paintwork to Brem color list with colored brackets
+15/25%

Electric version e.Quar, page 253

STANDARD FITTING REG ø 1/2"

On request: QUAR with depth 5,5 cm and fitting EG ø3/8"

Special fittings page 279



TAPPING CENTRES

MOD. QUAR

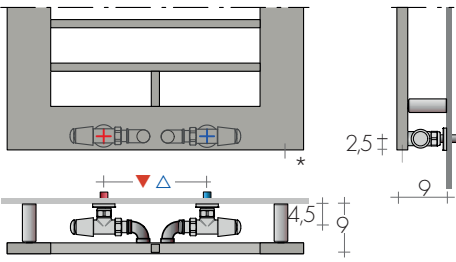

*sleeve E.H.E.
Dual Fuel version

MOD. QUAR-P

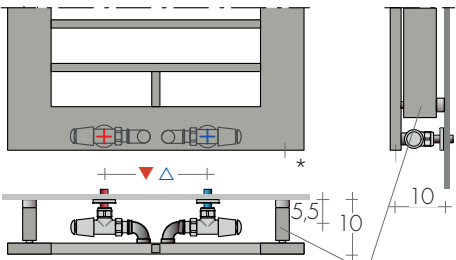

QUAR-P
with radiating tubes at the rear

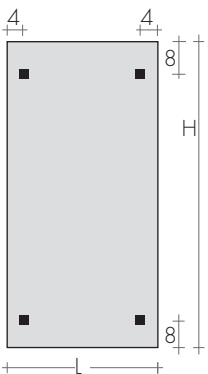

FIXINGS
Brackets included:
B70 for QUAR
B15 for QUAR-P



QUAR 127-46

RECOMMENDED VALVES

CHROME VALVES KIT with:

- n°2 Valves with tailpieces
- n°2 Fittings (multilayer \varnothing 16, copper \varnothing 12, 14)
- n°2 Chrome wall plates \varnothing 48, hole \varnothing 16

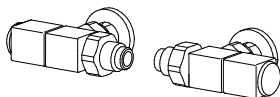

REVERSE QUADRA VALVES KIT
page 271 Art. KQR 180,10€
Extra for BREM color list 53,40€

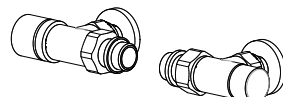

REVERSE CYL VALVES KIT with thermostatic option,
page 273 Art. KCR 149,90€
Extra for BREM color list 53,40€

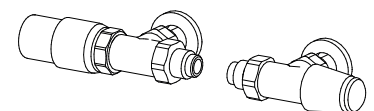

REVERSE TON VALVES KIT with THERMOSTATIC
Head page 273 Art. KTR 190,30€

SPECIAL FINISHES

Finishes Gold, Bronze, Brushed Nickel for 2 valves
Brushed Nickel FITTING KIT extra Art. RN 30,50€

page 267

REMOTE FITTINGS

Art. REM 42,10€
Tapping centres: at the rear of radiator \blacktriangle \blacktriangledown L - 6cm
DISTANT Valves page 274

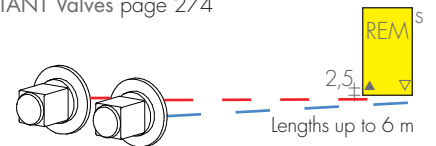

REM

2.5

Lengths up to 6 m

VISION VISION-ST

design Luigi Brembilla

Like looking out of a window or down a stairwell. Spaces that get smaller and smaller,

forming a 3D frame that both heats and decorates. Spaces that create an absolutely

novel radiator that will never go unobserved: only later is it discovered and remarked upon.

DIMENSIONS

Width: 48/56/64/80/96/112 cm

Height: 48/56/64/80/96/128 cm

Depth: 12/14/22/24 cm

Depth from wall: 15,5/17,5/25,5/27,5 cm

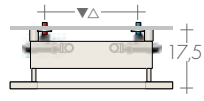

VISION-1

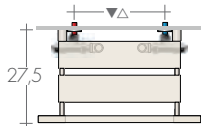

VISION-2

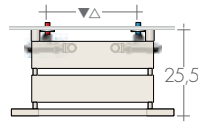

VISION-2ST

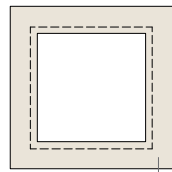

VISION.. 48-48
VISION.. 56-56
VISION.. 64-64

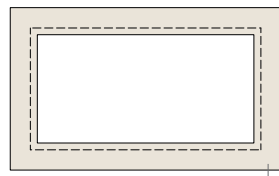

VISION.. 48-80
VISION.. 48-96
VISION.. 56-96
VISION.. 56-112
VISION.. 64-112

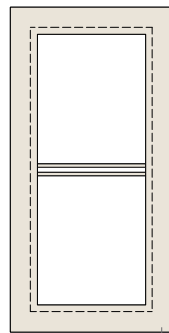

VISION..ST 80-48

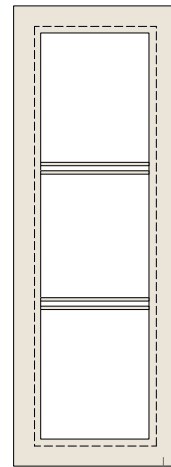

VISION..ST 128-..

VISION-1ST VISION-2ST

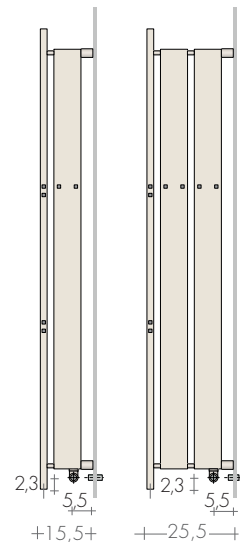

MODEL	H-L cm	Standard white sablé SB9016 €	EN 442			▲ ▽ t.c. cm	Height H cm	Width L cm	Depth P cm	Weight M Kg	Volume V dm ³	DUAL FUEL VERSION with E.H.E. and sleeve	
			Δt 50K watt	Δt 40K watt	Δt 30K watt							Watt	€
VISION-1	48-48	717,90	322	245	172	27	48	48	14	6,4	3,9	300	126,20
VISION-1	56-56	747,60	391	297	208	35	56	56	14	7,8	4,7	400	127,40
VISION-1	64-64	810,70	461	351	246	43	64	64	14	9,2	5,6	500	129,60
VISION-2	48-48	988,60	462	351	246	27	48	48	24	9,3	5,7	500	129,60
VISION-2	56-56	1068,60	565	430	301	35	56	56	24	11,4	6,9	500	129,60
VISION-2	64-64	1116,50	667	507	356	43	64	64	24	13,5	8,2	650	131,80
VISION-1	48-80	822,50	461	351	246	59	48	80	14	9,2	5,6	500	129,60
VISION-1	48-96	872,30	530	403	282	75	48	96	14	10,2	6,4	500	129,60
VISION-1	48-112	963,40	600	456	320	91	48	112	14	11,6	7,2	650	131,80
VISION-1	56-96	876,50	565	430	301	75	56	96	14	17,1	10,4	500	129,60
VISION-1	56-112	895,20	635	483	338	91	56	112	14	12,3	7,6	650	131,80
VISION-1	64-112	946,00	669	509	357	91	64	112	14	20,2	12,3	650	131,80
VISION-2	48-80	1138,90	667	507	356	59	48	80	24	13,5	8,2	650	131,80
VISION-2	56-96	1226,10	821	624	438	75	56	96	24	28,3	17,2	800	136,60
VISION-2	64-112	1310,00	975	741	520	91	64	112	24	33,5	20,3	900	140,20
VISION-1ST	80-48	936,00	475	361	251	27	80	48	12	9,2	5,6	500	129,60
VISION-1ST	128-48	1109,70	709	539	378	27	128	48	12	13,5	8,3	650	131,80
VISION-1ST	128-56	1178,20	745	567	393	35	128	56	12	15,4	9,2	800	136,60
VISION-2ST	80-48	1312,20	681	518	360	27	80	48	22	13,5	8,2	650	131,80
VISION-2ST	128-48	1506,10	1015	772	541	27	128	48	22	19,7	12,2	900	140,20
VISION-2ST	128-56	1590,30	1067	811	563	35	128	56	22	22,4	13,5	1200	148,50

Thermostats p.208-209

STANDARD PRODUCTION

White sablé SB9016 paintwork - B35 brackets
Tolerance ± 3 mm - Air vent ø 1/8"

MAXIMUM OPERATING PRESSURE 4 BAR

PRODUCTION ON REQUEST

Paintwork to Brem color list with
colored B35 brackets

Electric version e.Vision, page 262

+15/25%

STANDARD FITTING

REG ø 1/2"

On request fitting ø3/8"

Special fittings page 279



TAPPING CENTRES

MOD. VISION

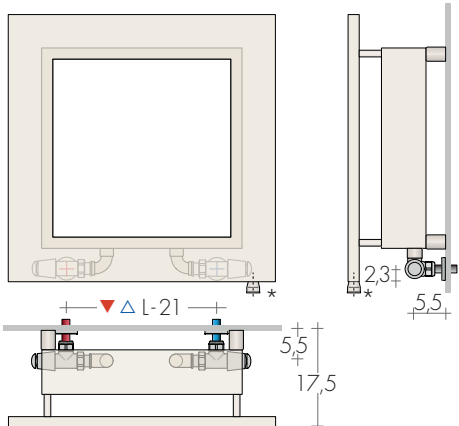

*sleeve E.H.E.
Dual Fuel version

MOD. VISION-ST

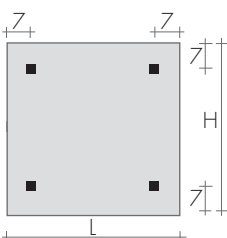
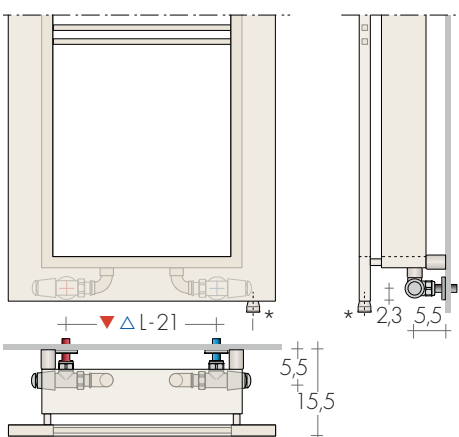

FIXINGS
Brackets included

RECOMMENDED VALVES

CHROME VALVES KIT with:

- n°2 Valves with chrome tailpieces
- n°2 Fittings (multilayer ø16, copper ø12, 14)
- n°2 Chrome wall plates ø 48, hole ø16



REVERSE CYL VALVES KIT with thermostatic option,
page 273 Art. KCR 149,90€

Extra for BREM color list 53,40€

KIT Fitting brushed NICKEL Art. RN 30,50€

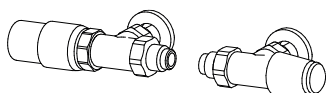

REVERSE TON VALVES KIT with THERMOSTATIC
Head page 273 Art. KTR 190,30€



VISION-1 48-48



VISION-2 ST 128-56



PANELS INDEX

RADIATORS WITH PANEL AND FLAT TUBES

RADIATORS COLLECTION

	page
CLAK	86
C-ProLux®	90
EGON	94
LAMINA	98
OPEN	102
PHUL	106
SO-FLEX	108
S-PLATT	110
SUIT	114

TOWEL HEATERS COLLECTION

	page
CAMEO	120
CLARK	122
CUBICO	124
DUO	126
FLAG	128
GEOMETRICA	130-132
HOT	134
LOGGIA D/T	136
MANT	138
PLATT COLOR	140
PLATT INOX	142
PLATT FO/FA	143
UNI-PLATT	144
VELETTA	146



LAMINA

CLAK

S-PLATT



CLAK-CKH

CLAK is an ultra thin panel with a refined minimalist look, just 2,3 cm thick: the

version with tubes at the rear is just 4,3 cm thick. This solution projects no more than

5,8 cm, it can be reduced with straight valves only.

DIMENSIONS - VERTICAL PANEL

Lengths: from 27 to 90 cm (every 9 cm)
 Heights: from 140 to 240 cm (every 20 cm)
 Depth: 2,3 cm and 4,3 cm
 Depth from wall: from 5,8 cm

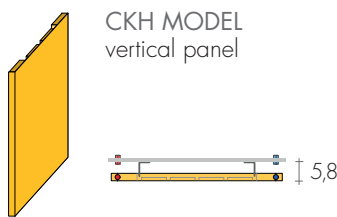

CKH

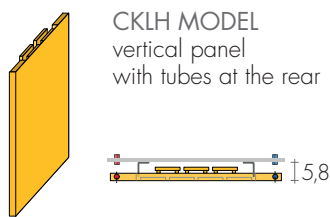

CKLH

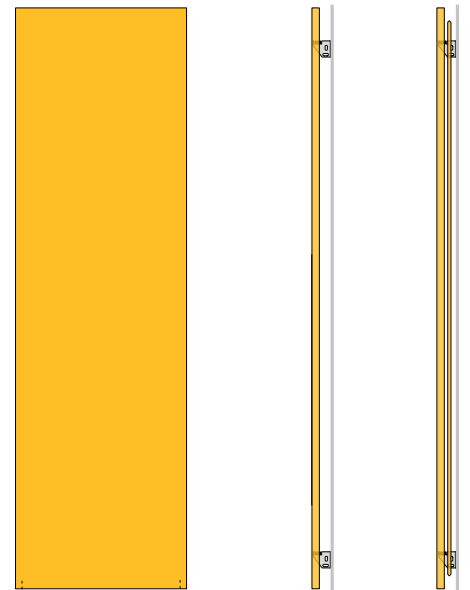

CKH ... CKLH ...

CKH

CKLH

Mod. CLAK H cm	L cm	27		36		45		54		63		72		81		90	
		▲	▼	cm	cm	cm	cm	cm	cm	cm	cm	cm	cm	cm	cm	cm	cm
CKH 140	€	813,50	893,60	983,50	1072,20	1155,70	1239,80	1327,90	1413,40	422w	556w	692w	828w	962w	1098w	1234w	1370w
CKLH 140	€	1076,00	1189,80	1315,20	1418,00	1536,40	1650,20	1767,80	1879,90	497w	707w	918w	1129w	1338w	1550w	1761w	1972w
CKH 160	€	868,20	956,40	1048,80	1143,10	1234,00	1323,50	1417,20	1508,20	482w	635w	790w	945w	1098w	1253w	1408w	1563w
CKLH 160	€	1136,40	1254,50	1373,00	1492,30	1613,20	1731,70	1852,30	1970,40	568w	808w	1050w	1291w	1531w	1773w	2014w	2256w
CKH 180	€	922,70	1018,90	1114,40	1213,70	1312,00	1407,10	1506,80	1603,20	541w	713w	887w	1061w	1233w	1407w	1581w	1755w
CKLH 180	€	1196,80	1319,40	1430,50	1566,70	1690,20	1813,00	1936,80	2060,60	639w	909w	1181w	1453w	1723w	1996w	2268w	2540w
CKH 200	€	972,80	1074,10	1177,50	1274,10	1376,40	1477,20	1578,10	1681,60	601w	792w	985w	1178w	1369w	1562w	1755w	1948w
CKLH 200	€	1284,60	1418,90	1551,00	1694,40	1817,60	1950,10	2082,80	2213,60	710w	1011w	1313w	1616w	1916w	2219w	2521w	2824w
CKH 220	€	1031,60	1138,40	1246,00	1367,50	1464,70	1572,50	1677,60	1788,10	660w	870w	1082w	1294w	1504w	1716w	1928w	2141w
CKLH 220	€	1335,70	1475,70	1613,00	1762,30	1890,60	2027,90	2166,00	2302,10	781w	1112w	1445w	1778w	2109w	2441w	2774w	3107w
CKH 240	€	1106,10	1222,50	1338,50	1454,50	1570,70	1687,10	1803,10	1922,30	720w	949w	1180w	1411w	1640w	1871w	2102w	2333w
CKLH 240	€	1387,10	1532,20	1675,00	1830,30	1963,60	2106,00	2249,20	2390,40	852w	1213w	1577w	1940w	2301w	2664w	3028w	3391w

Other sizes on request

Δt different from 50 K: consult technical data Brem

MAGNETIC ACCESSORIES p. 277

HOW TO ORDER

State: model (simple model or with tubes),
 height, width, fitting and color
 e.g.: CKH 180 - 35, EG ø 3/8", SB7035

STANDARD PRODUCTION

White sablé SB9016 paintwork, EOS brackets
 Tolerance ± 3mm - Air vent ø 1/8"
 MAXIMUM OPERATING PRESSURE 4 BAR

PRODUCTION ON REQUEST

Paintwork to BREM color list +15/25%
 Stainless steel finish, by estimate
 Electric version e.Clak, pag. 216

STANDARD FITTING

EG ø 3/8"
 ø 1/2" with sleeve on request
 Special fittings, page 278

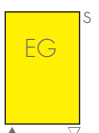

TAPPING CENTRES 3/8" vertical fittings

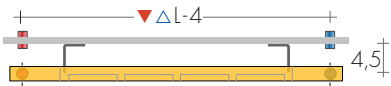
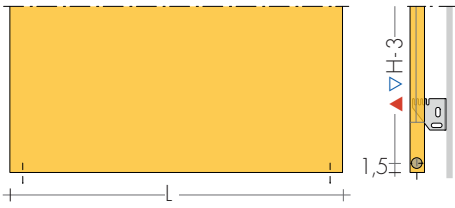

CKH MODEL

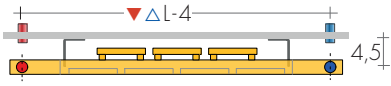

CKLH MODEL

Side fittings on request ▲▼ H - 3 cm
Extra Art. AS 91,20€



Fitting \varnothing 3/8"
STANDARD
(without sleeves)



Fitting \varnothing 1/2"
ON REQUEST
(with sleeves)

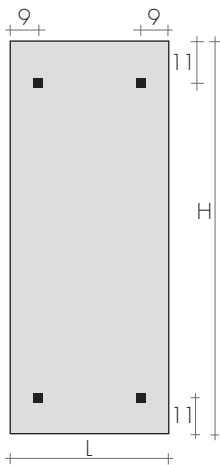

FIXINGS
Brackets included



EOS bracket



CLAK CKH 160-45

RECOMMENDED VALVES

CHROME VALVES KIT with:

- n°2 Valves with tailpieces
- n°2 Fittings (multilayer \varnothing 16, copper \varnothing 12, 14)
- n°2 Chrome wall plates \varnothing 48, hole \varnothing 16

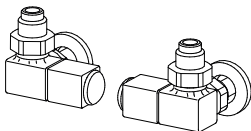

SIDE CONTROL QUADRA VALVES KIT
page 271 Art. KQL 191,20€
Extra for BREM color list 53,40€

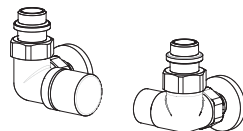

SIDE CONTROL CYL VALVES KIT with THERMO-
STATIC option, page 273 Art. KCL 162,50€
Extra for BREM color list 53,40€

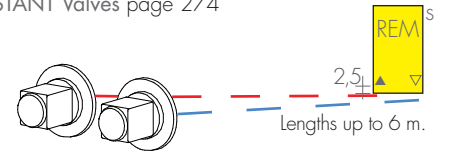

REMOTE FITTINGS Art. REM 42,10€
Tapping centres: at the rear of radiator ▲▼ L - 5 cm
DISTANT Valves page 274

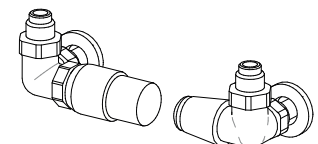

SIDE CONTROL TON VALVES KIT with Thermo-
static Head, page 269 Art. KTL 203,70€

CLAK-CKV

CLAK is an ultra thin panel with a refined minimalist look, only 2,3 cm thick: the version

with tubes at the rear is just 4,3 cm thick. This solution projects no more than 5,8 cm

from the wall thanks to BREM $\varnothing 3/8''$ valves and can be laid vertically or horizontally.

DIMENSIONS - HORIZONTAL PANEL

Length: from 50 to 220 cm

Heights: from 45 to 90 cm (every 9 cm)

Depth: 2,3 cm and 4,3 cm

Depth from wall: from 5,8 cm

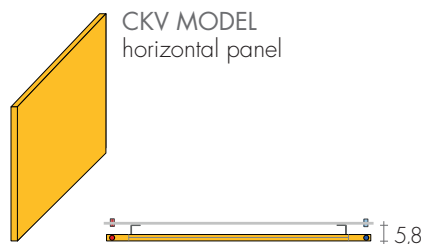

CKV

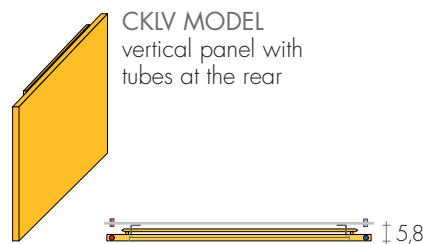

CKLV

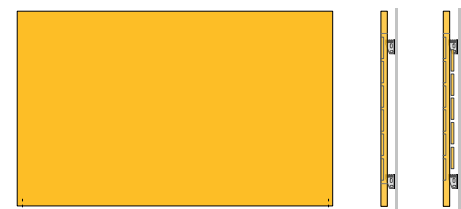

CKV ... CKLV ...

CKV CKLV

Mod. CLAK	L	EN 442 Watt Δt 50K (Δt 40K = $W \times 0,755$) - (Δt 30K = $W \times 0,526$)											
		50	60	70	80	90	100	120	140	160	180	200	220
	$\blacktriangle \blacktriangledown$	47	57	67	77	87	97	117	137	157	177	197	217
CKV 45	€	852,10	886,60	913,40	944,40	977,10	1009,60	1072,60	1134,10	1205,80	1239,70	1274,00	1311,90
H 45		253w	302w	351w	399w	448w	497w	595w	692w	790w	887w	985w	1082w
CKLV 45	€	1111,40	1164,00	1210,10	1256,10	1306,70	1351,60	1451,00	1542,10	1646,40	1698,20	1749,40	1803,10
		325w	391w	457w	523w	588w	654w	786w	918w	1050w	1181w	1313w	1445w
CKV 54	€	896,70	932,00	967,30	1003,30	1038,50	1074,00	1146,20	1217,60	1300,80	1340,80	1381,00	1420,60
H 54		304w	362w	420w	478w	537w	595w	712w	828w	945w	1061w	1178w	1294w
CKLV 54	€	1148,40	1200,60	1250,90	1303,40	1355,70	1407,00	1510,80	1610,70	1715,70	1771,20	1826,90	1883,20
		399w	480w	562w	643w	724w	805w	967w	1129w	1291w	1453w	1616w	1778w
CKV 63	€	950,50	990,90	1028,70	1068,50	1110,50	1150,70	1231,60	1309,70	1396,80	1440,10	1483,40	1525,70
H 63		352w	420w	488w	555w	623w	691w	827w	962w	1098w	1233w	1369w	1504w
CKLV 63	€	1248,90	1313,30	1371,90	1432,00	1496,00	1553,40	1677,70	1797,00	1926,50	1990,30	2053,70	2117,50
		472w	568w	664w	761w	857w	953w	1146w	1338w	1531w	1723w	1916w	2109w
CKV 72	€	1001,50	1049,10	1094,9	1140,60	1187,40	1231,90	1324,50	1409,90	1502,00	1548,50	1594,90	1639,50
H 72		403w	480w	557w	635w	712w	789w	944w	1098w	1253w	1407w	1562w	1716w
CKLV 72	€	1305,40	1374,70	#N/D	1505,60	1571,10	1640,40	1774,10	1901,90	2035,10	2102,40	2169,70	2236,10
		546w	658w	769w	881w	992w	1104w	1327w	1550w	1773w	1996w	2219w	2441w
CKV 81	€	1092,00	1140,70	1192,60	1240,00	1292,90	1339,20	1442,40	1533,70	1636,70	1686,70	1736,80	1786,80
H 81		453w	540w	627w	714w	800w	887w	1061w	1234w	1408w	1581w	1755w	1928w
CKLV 81	€	1395,90	1466,30	1536,80	1607,30	1679,20	1749,70	1892,30	2026,70	2173,70	2244,80	2316,30	2386,00
		621w	747w	874w	1001w	1128w	1254w	1508w	1761w	2014w	2268w	2521w	2774w
CKV 90	€	1166,40	1219,60	1269,60	1322,40	1375,10	1425,30	1529,40	1627,50	1737,90	1790,40	1843,50	1896,30
H 90		504w	600w	696w	793w	889w	985w	1178w	1370w	1563w	1755w	1948w	2141w
CKLV 90	€	1474,10	1550,10	1623,50	1696,60	1769,80	1844,60	1990,70	2131,70	2283,20	2356,30	2430,10	2504,60
		695w	837w	979w	1121w	1263w	1405w	1688w	1972w	2256w	2540w	2824w	3107w

Δt different from 50 K: consult technical data Brem

HOW TO ORDER

State: model (simple model or with tubes), height, width, fitting and color
e.g.: CKLV 72-180, EG $\varnothing 3/8''$, SB 7035

STANDARD PRODUCTION

White sablé SB9016 paintwork, EOS brackets
Tolerance ± 3 mm - Air vent $\varnothing 1/8''$
MAXIMUM OPERATING PRESSURE 4 BAR

PRODUCTION ON REQUEST

Paintwork to BREM color list +15/25%
Stainless steel finish, on request
Electric version e.Clak, pag. 216

STANDARD FITTING

EG $\varnothing 3/8''$
 $\varnothing 1/2''$ with sleeve on request
Special fittings, page 278



TAPPING CENTRES EG 3/8" vertical fittings

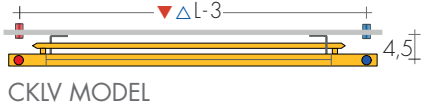
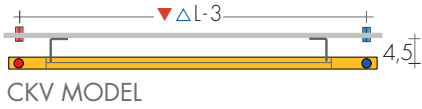

Side fittings on request ▲▼ H - 4cm
Extra Art. AS 91,20€



Fitting ø 3/8" STANDARD (without sleeves)



Fitting ø 1/2" ON REQUEST (with sleeves)

FIXINGS
Brackets included



EOS bracket

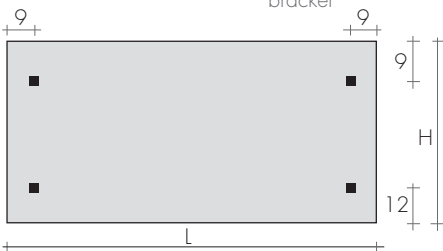

RECOMMENDED VALVES

CHROME VALVES KIT with:

- n°2 Valves with tailpieces
- n°2 Fittings (multilayer ø 16, copper ø 12, 14)
- n°2 Chrome wall plates ø 48, hole ø 16

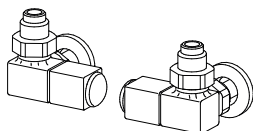

SIDE CONTROL QUADRA VALVES KIT
page 271 Art. KQL 191,20€
Extra for BREM color list 53,40€

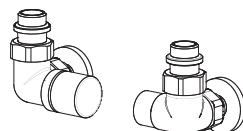

SIDE CONTROL CYL VALVES KIT with THERMO-
STATIC option, page 273 Art. KCL 162,50€
Extra for BREM color list 53,40€

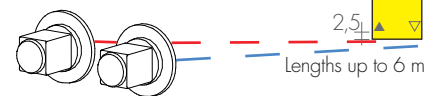

REMOTE FITTINGS Art. REM 42,10€
Tapping centres: at the rear of radiator ▲▼ L - 5 cm
DISTANT Valves page 274

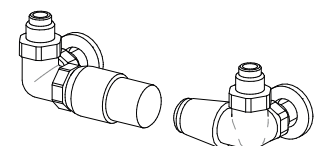

SIDE CONTROL TON VALVES KIT with Thermo-
static Head, page 269 Art. KTL 203,70€



CLAK CKV 45-160

C-Prolux®

STANDARD WHITE RAL 9016 PAINTWORK

Low, very low, attractive, with a flat front with a minimal presence, practical for the

most various usages. The high convective heating power of this

model is obtained through the application of fins that increase heat output considerably.

MODEL C... ..

H = 7 - 14 - 21 - 28 cm
L = 50 to 600 cm

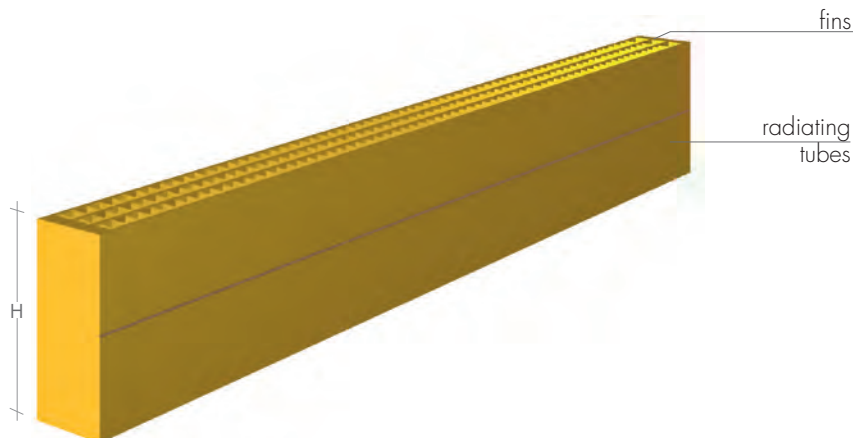

MODEL C...
front and rear in radiating tubes

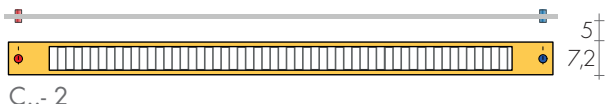

C..- 2

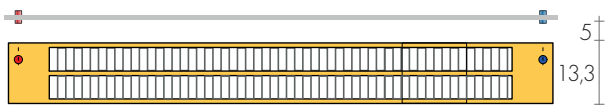

C..- 3

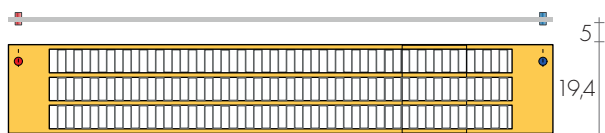

C..- 4

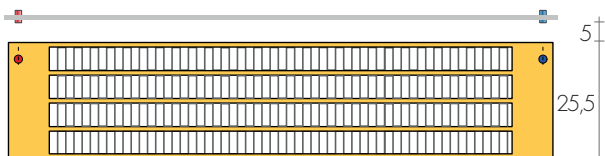

C..- 5

MODEL C... /L
with fins at rear

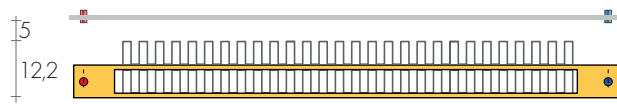

C..- 2/L

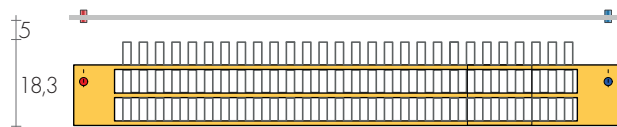

C..- 3/L



C..- 4/L

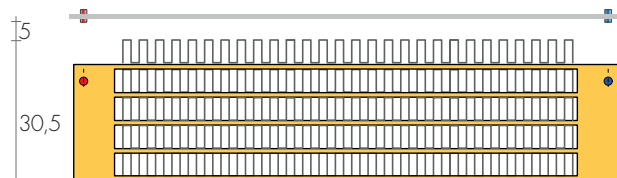

C..- 5/L

HOW TO ORDER

State: model (L indicates fins at the rear), height in cm, n. of radiating tubes and length in cm; fittings and color if different from standard.
eg.: C14-3L 360 AC ø 1/2" RAL 7015

STANDARD PRODUCTION

White glossy paintwork RAL 9016
Brackets and feet not included; Air vent ø1/2"
Maximum operating pressure 6 bar

PRODUCTION ON REQUEST

Painting Brem colors list up to 3m or 100 kg (besides that, feasibility to be required), RAL CLASSIC and NCS range +30%

STANDARD FITTINGS

EG ø 1/2"
AC or BD fittings on request
Special fittings, page 278



TAPPING CENTRES

EG vertical fittings as standard
Side fittings on request without extra

Models with tubes at the rear

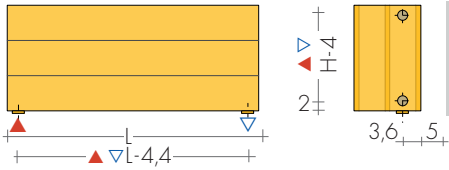

Models with fins at the rear

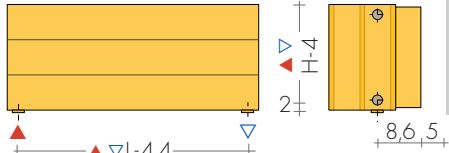

Mod. C7 (h 7 cm)

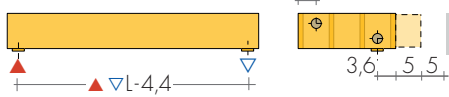

Offset fittings on the same side only for:
C7-3, C7-3/L, C7-4, C7-4/L, C7-5, C7-5/L

Coupling protrusions: 3 mm for $\varnothing 1/2"$
17mm for $\varnothing 3/4"$



C-PROLUX FIXINGS

In C-Prolux radiators, the brackets and feet in soundproofed plastic are not included in the packaging.
The number of brackets and feet varies according to the diagrams provided.

Diagrams for the positions of the feet or brackets for the C-Prolux assembly

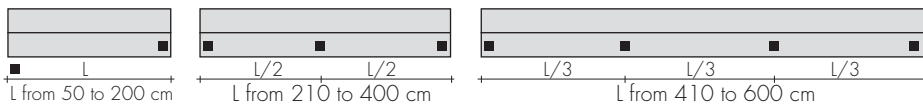

FIXINGS ON WALL

Brackets for convectors are provided on request:

galvanised Art.142 50,30€
white Art.142W 67,50€

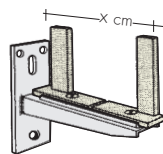

FEET

Adjustable zinc-plated feet and sound-proofed supports:

galvanised Art.150 60,30€
with Art.150W 85,20€

H = 9/12 cm (standard)
On request
H = 6,5/9 cm
H = 12/18 cm
H = 18/27 cm
H = 27/37 cm

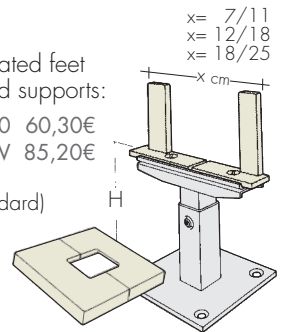

Plastic foot covers (80x80x4mm) are available in white colour only. Art. 156 16,20€

RECOMMENDED VALVES

CHROME VALVES KIT with:

- n°2 Valves with chrome tailpieces
- n°2 Fittings (multilayer $\varnothing 16$, copper $\varnothing 12, 14$)
- n°2 Chrome wall plates $\varnothing 48$, hole $\varnothing 16$

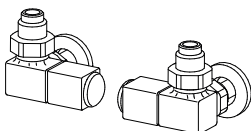

SIDE CONTROL QUADRA VALVES KIT
page 271 Art. KQL 191,20€
Extra for BREM color list 53,40€

SPECIAL FINISHES

page 267
Finishes Gold, Bronze, Brushed Nickel for 2 valves
Brushed Nickel FITTING KIT extra Art. RN 30,50€

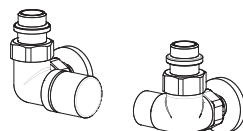

SIDE CONTROL CYL VALVES KIT with THERMO-
STATIC option, page 273 Art. KCL 162,50€
Extra for BREM color list 53,40€

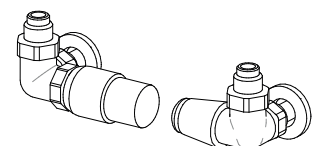

SIDE CONTROL TON VALVES KIT with Thermo-
static Head, page 269 Art. KTL 203,70€

C-Prolux®

STANDARD WHITE RAL 9016 PAINTWORK

MOD	L cm	50	60	70	80	90	100	110	120	130	140	150	160	170	180	190	200
C7-2	€	359,00	373,00	386,60	400,50	414,40	428,30	442,00	456,00	469,60	483,40	497,10	511,10	524,90	538,80	552,60	566,30
		174w	209w	244w	279w	314w	349w	384w	419w	454w	489w	524w	558w	593w	628w	663w	698w
C7-2/L	€	432,90	452,30	471,30	490,40	509,30	528,40	547,60	566,70	585,90	604,90	624,00	643,00	662,40	681,50	700,60	719,70
		202w	243w	284w	324w	365w	405w	446w	486w	527w	567w	608w	648w	689w	729w	770w	810w
C7-3	€	489,00	511,20	533,60	556,00	578,30	600,50	623,10	645,50	667,90	689,90	712,40	734,70	757,10	779,30	801,80	824,10
		296w	356w	415w	474w	534w	593w	652w	712w	771w	830w	890w	949w	1008w	1067w	1127w	1186w
C7-3/L	€	561,00	586,50	612,20	637,70	663,40	689,10	714,70	740,10	765,90	791,50	816,90	842,60	868,20	893,80	919,30	945,20
		321w	385w	449w	514w	578w	642w	706w	770w	835w	899w	963w	1027w	1091w	1156w	1220w	1284w
C7-4	€	620,30	653,90	687,20	721,10	754,40	787,90	821,40	855,00	888,60	922,10	955,60	989,20	1022,7	1056,3	1089,8	1123,2
		406w	488w	569w	650w	732w	813w	894w	976w	1057w	1138w	1220w	1301w	1382w	1463w	1545w	1626w
C7-4/L	€	679,30	715,90	752,60	788,90	825,80	862,30	898,80	935,60	971,90	1008,8	1045,1	1081,9	1118,5	1154,9	1191,7	1228,0
		468w	562w	656w	750w	843w	937w	1031w	1124w	1218w	1312w	1406w	1499w	1593w	1687w	1780w	1874w
C7-5	€	751,30	793,40	835,90	878,20	920,50	962,50	1005,0	1047,3	1089,6	1131,6	1174,1	1216,4	1258,8	1300,9	1343,3	1385,6
		512w	615w	718w	820w	922w	1025w	1128w	1230w	1332w	1435w	1538w	1640w	1743w	1845w	1948w	2050w
C7-5/L	€	908,40	961,30	1014,3	1067,4	1120,3	1173,2	1226,2	1279,0	1332,1	1385,0	1438,0	1490,9	1543,7	1596,8	1649,6	1702,7
		582w	698w	814w	930w	1047w	1163w	1279w	1396w	1512w	1628w	1745w	1861w	1977w	2093w	2210w	2326w
C14-2	€	491,20	515,50	540,00	564,50	588,70	613,10	637,50	661,80	686,30	710,50	735,10	759,50	783,70	808,20	832,70	857,00
		272w	326w	380w	434w	489w	543w	597w	652w	706w	760w	814w	869w	923w	977w	1032w	1086w
C14-2/L	€	604,40	644,10	684,20	724,00	763,70	803,60	843,40	883,30	922,90	962,90	1002,7	1042,4	1082,5	1122,1	1162,2	1201,9
		364w	436w	509w	582w	654w	727w	800w	872w	945w	1018w	1091w	1163w	1236w	1309w	1381w	1454w
C14-3	€	672,60	719,80	767,00	814,20	861,20	908,20	955,50	1002,6	1049,7	1096,9	1144,0	1191,3	1238,2	1285,5	1332,6	1379,7
		439w	527w	615w	702w	790w	878w	966w	1054w	1141w	1229w	1317w	1405w	1493w	1580w	1668w	1756w
C14-3/L	€	748,40	799,60	850,90	902,30	953,00	1004,4	1055,6	1107,0	1158,0	1209,3	1260,4	1311,7	1363,0	1414,0	1465,3	1516,6
		538w	646w	754w	862w	969w	1077w	1185w	1292w	1400w	1508w	1616w	1723w	1831w	1939w	2046w	2154w
C14-4	€	865,20	931,30	997,00	1062,8	1128,7	1194,6	1260,3	1326,3	1392,2	1457,9	1523,9	1589,7	1655,5	1721,4	1787,3	1853,2
		592w	711w	830w	948w	1067w	1185w	1304w	1422w	1541w	1659w	1778w	1896w	2015w	2133w	2252w	2370w
C14-4/L	€	922,90	990,90	1058,6	1126,6	1194,6	1262,4	1330,1	1398,4	1466,1	1533,8	1601,9	1669,8	1737,6	1805,3	1873,4	1941,2
		701w	841w	981w	1122w	1262w	1402w	1542w	1682w	1823w	1963w	2103w	2243w	2383w	2524w	2664w	2804w
C14-5	€	1082,3	1171,0	1259,6	1347,9	1436,8	1525,4	1613,9	1702,5	1791,2	1879,7	1968,3	2056,9	2145,5	2234,1	2322,7	2411,4
		743w	892w	1040w	1189w	1337w	1486w	1635w	1783w	1932w	2080w	2229w	2378w	2526w	2675w	2823w	2972w
C14-5/L	€	1346,2	1462,3	1577,9	1693,6	1809,2	1924,8	2040,6	2156,3	2271,8	2387,5	2503,3	2619,0	2734,7	2850,4	2966,1	3081,7
		847w	1016w	1185w	1354w	1524w	1693w	1862w	2032w	2201w	2370w	2540w	2709w	2878w	3047w	3217w	3386w
C21-2	€	607,30	639,00	670,50	702,40	733,90	765,90	797,30	829,40	860,70	892,40	924,20	955,80	987,80	1019,3	1051,2	1082,7
		346w	415w	484w	553w	622w	691w	760w	829w	898w	967w	1036w	1106w	1175w	1244w	1313w	1382w
C21-2/L	€	698,40	743,10	788,30	833,40	878,80	923,80	968,60	1013,7	1059,0	1104,3	1149,3	1194,5	1239,4	1284,4	1329,6	1374,8
		488w	586w	684w	782w	879w	977w	1075w	1172w	1270w	1368w	1466w	1563w	1661w	1759w	1856w	1954w
C21-3	€	766,60	820,70	874,80	928,80	983,00	1037,1	1091,1	1145,0	1199,1	1253,2	1307,4	1361,2	1415,5	1469,4	1523,4	1577,7
		564w	676w	789w	902w	1014w	1127w	1240w	1352w	1465w	1578w	1690w	1803w	1916w	2029w	2141w	2254w
C21-3/L	€	855,00	915,60	976,20	1036,8	1097,4	1157,7	1218,1	1278,8	1339,5	1400,0	1460,5	1521,2	1582,0	1642,4	1703,0	1763,6
		708w	849w	991w	1132w	1274w	1415w	1557w	1698w	1840w	1981w	2122w	2264w	2406w	2547w	2688w	2830w
C21-4	€	1012,7	1091,2	1170,0	1248,6	1327,2	1405,8	1484,6	1563,3	1641,8	1720,5	1799,1	1877,8	1956,3	2035,0	2113,9	2192,5
		820w	984w	1148w	1312w	1476w	1640w	1804w	1968w	2132w	2296w	2460w	2624w	2788w	2952w	3116w	3280w
C21-4/L	€	1093,8	1178,4	1262,9	1347,4	1431,9	1516,4	1601,0	1685,5	1770,0	1854,6	1939,9	2025,7	2111,2	2196,6	2281,5	2366,5
		904w	1085w	1266w	1446w	1627w	1808w	1989w	2170w	2350w	2531w	2712w	2893w	3074w	3254w	3435w	3616w
C21-5	€	1262,6	1367,5	1472,5	1577,3	1682,1	1787,0	1891,8	1996,7	2101,7	2206,5	2311,6	2416,1	2521,1	2626,1	2731,0	2835,7
		1046w	1255w	1464w	1674w	1883w	2092w	2301w	2510w	2720w	2929w	3138w	3347w	3556w	3766w	3975w	4184w
C21-5/L	€	1678,4	1807,9	1937,6	2067,3	2196,9	2326,5	2456,2	2585,5	2715,4	2844,9	2974,6	3104,2	3233,9	3363,7	3492,9	3622,6
		1102w	1322w	1542w	1762w	1983w	2203w	2423w	2644w	2864w	3084w	3305w	3525w	3745w	3965w	4186w	4406w
C28-2	€	731,40	772,20	812,70	853,70	894,10	935,00	975,40	1016,1	1056,7	1097,5	1138,0	1178,6	1219,7	1259,9	1300,8	1341,3
		404w	485w	566w	647w	728w	809w	890w	971w	1052w	1133w	1214w	1294w	1375w	1456w	1537w	1618w
C28-2/L	€	830,40	888,60	946,50	1004,9	1062,9	1121,2	1179,0	1237,2	1295,4	1353,4	1411,5	1469,7	1527,7	1585,9	1643,9	1702,3
		577w	692w	808w	923w	1039w	1154w	1269w	1385w	1500w	1616w	1731w	1846w	1962w	2077w	2193w	2308w
C28-3	€	905,50	975,40	1045,2	1115,2	1185,1	1255,2	1325,1	1395,0	1465,0	1534,5	1604,5	1674,4	1744,4	1814,3	1884,3	1954,3
		682w	818w	954w	1090w	1227w	1363w	1499w	1636w	1772w	1908w	2044w	2181w	2317w	2453w	2590w	2726w
C28-3/L	€	1001,6	1079,8	1157,6	1235,7	1313,8	1391,9	1469,8	1548,0	1625,8	1703,9	1782,1	1859,9	1938,0	2016,1	2094,2	2172,2
		840w	1008w	1176w	1344w	1512w	1680w	1848w	2016w	2184w	2352w	2520w	2688w	2856w	3024w	3192w	3360w
C28-4	€	1208,7	1310,1	1411,1	1512,2	1613,6	1714,8	1816,0	1917,1	2018,4	2119,7	2220,8	2321,9	2423,3	2524,5	2625,6	2727,0
		942w	1130w	1319w	1507w	1696w	1884w	2072w	2261w	2449w	2638w	2826w	3014w	3203w	3391w	3580w	3768w
C28-4/L	€	1301,0	1409,5	1518,0	1626,8	1735,2	1843,7	1952,3	2060,8	2169,3	2278,2	2386,5	2495,2	2603,6	2712,2	2820,7	2929,2
		1097w	1316w	1536w	1755w	1975w	2194w	2413w	2633w	2852w	3072w	3291w	3510w	3730w	3949w	4169w	4388

EN 442 Watt Δt 50K (Δt 40K = Wx0,755) - (Δt 30K = Wx0,526)

220	240	260	280	300	*320	*340	*360	*380	*400	*420	*440	*460	*480	*500	*600
594,00 768w	621,70 838w	649,30 907w	677,20 977w	704,80 1047w	732,30 1117w	759,90 1187w	787,70 1256w	815,20 1326w	842,90 1396w	870,60 1466w	898,10 1536w	925,90 1605w	953,50 1675w	981,10 1745w	1119,2 2094w
758,00 891w	796,20 972w	834,50 1053w	872,70 1134w	910,90 1215w	949,30 1296w	987,40 1377w	1025,7 1458w	1063,9 1539w	1102,1 1620w	1140,4 1701w	1178,6 1782w	1216,9 1863w	1255,3 1944w	1293,5 2025w	1484,6 2430w
868,80 1305w	913,40 1423w	958,0 1542w	1002,8 1660w	1047,4 1779w	1092,1 1898w	1136,8 2016w	1181,4 2135w	1226,2 2253w	1270,9 2372w	1315,4 2491w	1360,2 2609w	1404,9 2728w	1449,6 2846w	1494,2 2965w	1717,7 3558w
996,10 1412w	1047,4 1541w	1098,4 1669w	1149,8 1798w	1201,1 1926w	1252,2 2054w	1303,5 2183w	1354,5 2311w	1405,8 2440w	1456,9 2568w	1508,2 2696w	1559,4 2825w	1610,6 2953w	1661,9 3082w	1712,9 3210w	1969,0 3852w
1190,1 1789w	1257,4 1951w	1324,4 2114w	1391,5 2276w	1458,6 2439w	1525,6 2602w	1592,8 2764w	1659,8 2927w	1726,8 3089w	1793,9 3252w	1860,8 3415w	1927,9 3577w	1994,9 3740w	2062,0 3902w	2129,2 4065w	2464,2 4878w
1301,1 2061w	1374,4 2249w	1447,7 2436w	1521,0 2624w	1594,0 2811w	1667,1 2998w	1740,3 3186w	1813,6 3373w	1886,8 3561w	1959,8 3748w	2032,8 3935w	2105,9 4123w	2179,2 4310w	2252,3 4498w	2325,6 4685w	2691,4 5622w
1470,1 2255w	1554,7 2460w	1639,2 2665w	1723,9 2870w	1808,4 3075w	1893,0 3280w	1977,6 3485w	2062,1 3690w	2146,9 3895w	2231,4 4100w	2316,0 4305w	2400,4 4510w	2485,2 4715w	2569,6 4920w	2654,3 5125w	3077,0 6150w
1808,4 2559w	1914,2 2791w	2020,3 3024w	2126,2 3256w	2232,2 3489w	2338,0 3722w	2443,8 3954w	2549,7 4187w	2655,5 4419w	2761,6 4652w	2867,6 4885w	2973,4 5117w	3079,2 5350w	3185,2 5582w	3291,0 5815w	3820,5 6978w
906,00 1195w	954,60 1303w	1003,4 1412w	1052,0 1520w	1101,0 1629w	1149,7 1738w	1198,4 1846w	1247,1 1955w	1296,0 2063w	1344,7 2172w	1393,6 2281w	1442,4 2389w	1491,2 2498w	1539,9 2606w	1588,6 2715w	1832,7 3258w
1281,4 1599w	1361,2 1745w	1440,9 1890w	1520,4 2036w	1600,1 2181w	1679,9 2326w	1759,5 2472w	1839,3 2617w	1918,9 2763w	1998,6 2908w	2078,3 3053w	2158,1 3199w	2237,2 3344w	2317,2 3490w	2396,8 3635w	2795,2 4362w
1474,0 1932w	1568,4 2107w	1662,4 2283w	1756,8 2458w	1851,1 2634w	1945,3 2810w	2039,5 2985w	2133,8 3161w	2228,1 3336w	2322,3 3512w	2416,5 3688w	2510,9 3863w	2605,5 4039w	2699,5 4214w	2794,0 4390w	3265,0 5268w
1618,8 2369w	1721,3 2585w	1823,7 2800w	1926,1 3016w	2028,7 3231w	2130,8 3446w	2233,3 3662w	2335,8 3877w	2438,0 4093w	2540,4 4308w	2643,0 4523w	2745,3 4739w	2847,9 4954w	2950,2 5170w	3052,6 5385w	3564,7 6462w
1984,6 2607w	2116,7 2844w	2248,4 3081w	2380,0 3318w	2511,7 3555w	2643,5 3792w	2775,2 4029w	2907,0 4266w	3038,6 4503w	3170,6 4740w	3302,0 4977w	3433,9 5214w	3565,5 5451w	3697,2 5688w	3829,1 5925w	4487,5 7110w
2077,0 3084w	2212,7 3365w	2348,5 3645w	2484,4 3926w	2620,0 4206w	2756,0 4486w	2891,4 4767w	3027,4 5047w	3163,1 5328w	3298,8 5608w	3434,5 5888w	3570,3 6169w	3706,0 6449w	3842,0 6730w	3977,6 7010w	4656,5 8412w
2588,4 3269w	2765,8 3566w	2942,7 3864w	3120,2 4161w	3297,3 4458w	3474,6 4755w	3651,5 5052w	3828,9 5350w	4006,0 5647w	4183,3 5944w	4360,4 6241w	4537,8 6538w	4714,9 6836w	4891,9 7133w	5069,1 7430w	5955,3 8916w
3313,1 3725w	3544,5 4063w	3775,9 4402w	4007,2 4740w	4238,5 5079w	4470,0 5418w	4701,3 5756w	4932,6 6095w	5164,3 6433w	5395,4 6772w	5626,9 7111w	5858,4 7449w	6089,6 7788w	6321,2 8126w	6552,4 8465w	
1146,1 1520w	1209,8 1658w	1273,2 1797w	1336,4 1935w	1399,9 2073w	1463,3 2211w	1526,7 2349w	1590,2 2488w	1653,6 2626w	1717,0 2764w	1780,5 2902w	1843,9 3040w	1907,2 3179w	1970,8 3317w	2034,3 3455w	2351,4 4146w
1465,1 2149w	1555,1 2345w	1645,5 2540w	1735,7 2736w	1825,8 2931w	1916,2 3126w	2006,1 3322w	2096,3 3517w	2186,9 3713w	2277,1 3908w	2367,0 4103w	2457,5 4299w	2547,8 4494w	2637,9 4690w	2728,1 4885w	3179,1 5862w
1685,7 2479w	1793,9 2705w	1901,8 2930w	2010,0 3156w	2118,0 3381w	2226,2 3606w	2334,2 3832w	2442,6 4057w	2550,4 4283w	2658,5 4508w	2766,6 4733w	2874,8 4959w	2983,0 5184w	3091,0 5410w	3199,4 5635w	3739,7 6762w
1884,6 3113w	2005,7 3396w	2126,9 3679w	2248,1 3962w	2369,4 4245w	2490,5 4528w	2611,6 4811w	2732,8 5094w	2853,8 5377w	2975,1 5660w	3096,1 5943w	3217,4 6226w	3338,3 6509w	3459,6 6792w	3580,8 7075w	4186,7 8490w
2349,8 3608w	2507,1 3936w	2664,4 4264w	2821,4 4592w	2979,0 4920w	3136,2 5248w	3293,6 5576w	3450,7 5904w	3608,2 6232w	3765,7 6560w	3922,8 6888w	4080,0 7216w	4237,6 7544w	4395,0 7872w	4552,1 8200w	
2530,8 3978w	2699,6 4339w	2868,9 4701w	3037,9 5062w	3206,8 5424w	3375,9 5786w	3544,9 6147w	3714,0 6509w	3883,0 6870w	4052,0 7232w	4221,2 7594w	4390,2 7955w	4559,4 8317w			
3045,5 4602w	3255,3 5021w	3464,9 5439w	3674,6 5858w	3884,4 6276w	4094,3 6694w	4303,9 7113w	4513,7 7531w	4723,4 7950w	4933,2 8368w	5143,0 8786w	5352,6 9205w				
3882,0 4847w	4141,2 5287w	4400,4 5728w	4659,6 6168w	4918,9 6609w	5178,2 7050w	5437,4 7490w									
1422,7 1780w	1503,9 1942w	1585,2 2103w	1666,8 2265w	1748,0 2427w	1829,3 2589w	1910,5 2751w	1992,1 2912w	2073,0 3074w	2154,4 3236w	2236,0 3398w	2317,2 3560w	2398,5 3721w	2479,7 3883w	2561,1 4045w	2967,9 4854w
1818,4 2539w	1934,8 2770w	2050,9 3000w	2166,9 3231w	2283,5 3462w	2399,5 3693w	2516,1 3924w	2632,0 4154w	2748,1 4385w	2864,6 4616w	2980,8 4847w	3097,1 5078w	3213,2 5308w	3329,4 5539w	3445,9 5770w	4027,1 6924w
2094,2 2999w	2233,8 3271w	2373,7 3544w	2513,6 3816w	2653,4 4089w	2793,1 4362w	2932,9 4634w	3072,7 4907w	3212,7 5179w	3352,4 5452w	3492,3 5725w	3632,2 5997w	3772,2 6270w	3911,9 6542w	4051,7 6815w	4750,8 8178w
2328,1 3696w	2484,4 4032w	2640,5 4368w	2796,2 4704w	2952,3 5040w	3108,7 5376w	3264,6 5712w	3420,6 6048w	3576,8 6384w	3732,8 6720w	3888,6 7056w	4044,9 7392w	4201,1 7728w	4357,1 8064w		
2929,2 4145w	3131,9 4522w	3334,1 4898w	3536,4 5275w	3739,0 5652w	3941,5 6029w	4143,7 6406w	4346,4 6782w	4548,7 7159w	4751,0 7536w	4953,5 7913w					
3146,5 4827w	3363,7 5266w	3580,4 5704w	3797,6 6143w	4014,8 6582w	4231,9 7021w	4448,9 7460w									
3833,3 5269w	4105,7 5748w	4378,0 6227w	4650,4 6706w	4922,5 7185w	5195,0 7664w										

*Lengths over 3 meters,
TRANSPORT ON DEMAND
or ex work.

Lengths every 20cm between 5 and 6 m: interpolate heat outputs and prices

Δt different from 50 K: consult Technical data Brem

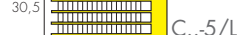
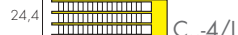
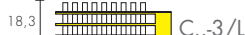

EGON

The EGON radiator is produced using flattened tubes, curved horizontally or vertically:

the imperceptible curvature of the tube, which determines the shape of the EGON radiator

is slightly larger than the traditional flattened tube and increases the emission of heat.

EH MODEL

with flat vertical tubes

L = from 1 to 15 el. (every 7,7 cm)

H = from 60 to 300 cm

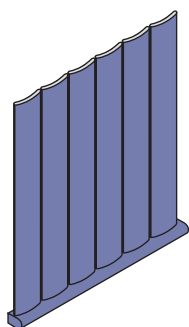

EH

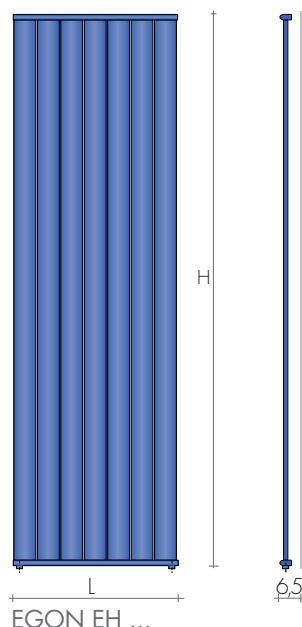

EGON EH ...

EV MODEL

with flat horizontal tubes

L = from 60 to 300 cm

H = from 1 to 15 elements
(every 7,65 cm)

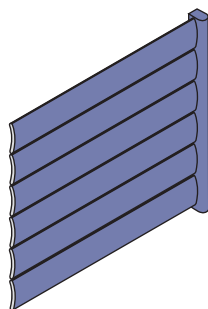

EV

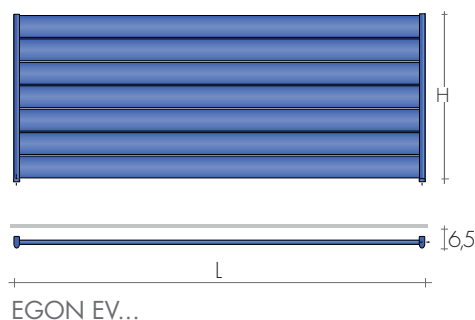

EGON EV...

HOW TO ORDER

State: model, height in cm, number of elements; fitting and color

E.g.: EH 180 - 5 el - EG \varnothing 1/2" - SB 9010

STANDARD PRODUCTION

White sablé SB9016 paintwork - EOS brackets
Air vent \varnothing 1/2" - Tolerance \pm 3 mm - Maximum
Maximum operating pressure, 4 BAR.

PRODUCTION ON REQUEST

Paintwork to Brem color list up to 3 m (ask for
feasibility in case of higher values) +15/25%
Feet and fixings page 276

STANDARD FITTINGS

EG \varnothing 1/2"
AC or BD fittings on request
Special fittings, page 278

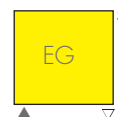

TAPPING CENTRES EH MODEL
EG vertical fittings as standard
Side fittings on request without extra
EH MODEL

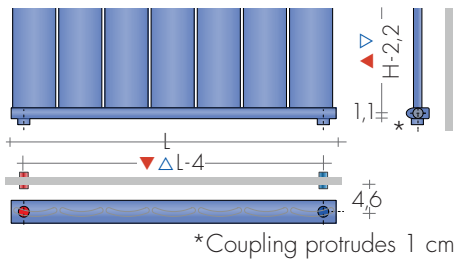

EV MODEL

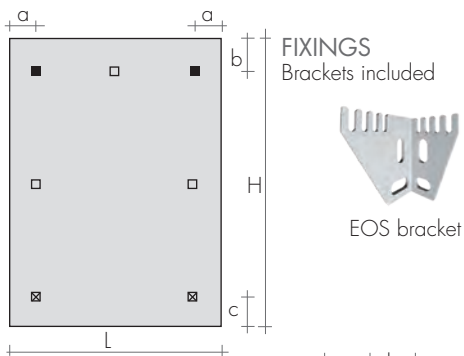
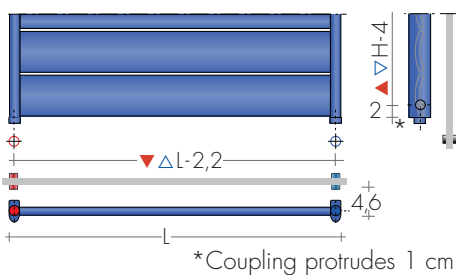

Mod.	a cm	b cm	c cm
EH	8	8	8
EV	8	9	7

□ from H or L 220 cm
⊗ for special fittings



RECOMMENDED VALVES

CHROME VALVES KIT with:

- n°2 Valves with chrome tailpieces
- n°2 Fittings (multilayer ø16, copper ø12, 14)
- n°2 Chrome wall plates ø 48, hole ø16

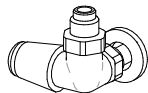

SIDE CONTROL TON VALVES KIT
page 271

Art. KVL 150,50€

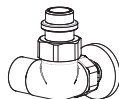
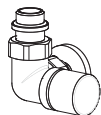

SIDE CONTROL CYL VALVES KIT with THERMO-
STATIC option, page 273 Art. KCL 162,50€
Extra for BREM color list 53,40€

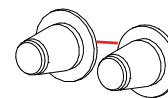

Lengths up to 6 m.

SPECIAL FINISHES page 267
Finishes Gold, Bronze, Brushed Nickel for 2 valves
Brushed Nickel FITTING KIT extra Art. RN 30,50€

REMOTE FITTINGS Art. REM 42,10€
Tapping centres: at the rear of radiator ▲▽ L-5 cm
DISTANT Valves page 274

SIDE CONTROL TON VALVES KIT with Thermo-
static Head, page 269 Art. KTL 203,70€

EGON

EN 442 Watt Δt 50K (Δt 40K = Wx0,755) - (Δt 30K = Wx0,526)

MOD.	(n° el)	1 el	2 el	3 el	4 el	5 el	6 el	7 el	8 el	9 el	10 el	11 el	12 el	13 el	14 el	15 el
L cm	8,0	15,7	23,5	31,2	39,0	46,7	54,5	62,2	70,0	77,7	85,5	93,3	101,0	108,8	116,5	
H cm	▲▼ cm	4,0	11,7	19,5	27,2	35,0	42,7	50,5	58,2	66,0	73,7	81,5	89,3	97,0	104,8	112,5
EH 60	€	164,30 51w	207,20 102w	250,80 153w	292,90 204w	336,10 255w	379,30 306w	420,00 357w	463,60 408w	506,90 459w	548,40 510w	592,30 561w	633,20 612w	677,20 663w	719,40 714w	761,00 765w
EH 80	€	189,10 68w	238,30 136w	289,10 204w	338,50 272w	387,90 340w	437,60 408w	487,10 476w	535,90 544w	587,10 612w	636,50 680w	684,40 748w	733,90 816w	783,20 884w	833,10 952w	883,50 1020w
EH 100	€	203,80 83w	257,90 166w	314,00 249w	367,90 332w	422,40 415w	478,40 498w	533,80 581w	589,60 664w	644,10 747w	698,40 830w	753,60 913w	808,10 996w	863,60 1079w	918,00 1162w	973,70 1245w
EH 120	€	223,80 97w	280,40 194w	338,50 291w	395,20 388w	454,70 485w	511,20 582w	569,50 679w	626,40 776w	684,40 873w	742,70 970w	800,40 1067w	857,60 1164w	915,30 1261w	973,70 1358w	1031,60 1455w
EH 140	€	233,30 112w	295,50 224w	358,50 336w	419,00 448w	481,60 560w	543,80 672w	604,40 784w	667,20 896w	728,70 1008w	791,80 1120w	852,30 1232w	914,30 1344w	977,10 1456w	1037,70 1568w	1100,00 1680w
EH 160	€	250,80 127w	321,30 254w	392,80 381w	464,40 508w	535,90 635w	607,70 762w	679,50 889w	751,10 1016w	822,60 1143w	893,40 1270w	964,80 1397w	1036,70 1524w	1108,60 1651w	1178,40 1778w	1251,90 1905w
EH 180	€	266,70 143w	342,40 286w	417,50 429w	494,10 572w	569,50 715w	644,90 858w	720,40 1001w	797,10 1144w	872,40 1287w	947,70 1430w	1023,10 1573w	1098,30 1716w	1173,80 1859w	1250,40 2002w	1326,10 2145w
EH 190	€	275,50 151w	352,40 302w	430,00 453w	506,90 604w	582,30 755w	660,00 906w	736,10 1057w	814,20 1208w	890,60 1359w	967,30 1510w	1045,10 1661w	1121,70 1812w	1198,60 1963w	1276,40 2114w	1352,70 2265w
EH 200	€	282,90 159w	360,90 318w	439,70 477w	518,30 636w	597,10 795w	674,70 954w	753,60 1113w	831,30 1272w	910,40 1431w	988,60 1590w	1067,40 1749w	1145,50 1908w	1223,20 2067w	1302,00 2226w	1380,30 2385w
EH 210	€	289,10 167w	370,70 334w	454,70 501w	535,90 668w	618,60 835w	701,90 1002w	783,20 1169w	866,10 1336w	948,50 1503w	1031,60 1670w	1114,40 1837w	1195,60 2004w	1278,50 2171w	1360,10 2338w	1444,20 2505w
EH 220	€	292,90 175w	380,70 350w	465,50 525w	552,40 700w	640,10 875w	726,50 1050w	811,80 1225w	899,40 1400w	985,70 1575w	1072,20 1750w	1160,00 1925w	1245,40 2100w	1331,70 2275w	1419,70 2450w	1505,70 2625w
EH 240	€	312,60 192w	404,10 384w	494,10 576w	585,20 768w	674,70 960w	766,20 1152w	856,50 1344w	947,70 1536w	1037,70 1728w	1129,00 1920w	1219,10 2112w	1310,80 2304w	1401,50 2496w	1492,40 2688w	1582,60 2880w
EH 260	€	327,40 208w	422,40 416w	520,00 624w	616,40 832w	711,60 1040w	808,10 1248w	904,40 1456w	1002,20 1664w	1096,90 1872w	1193,00 2080w	1289,90 2288w	1385,00 2496w	1482,40 2704w	1578,80 2912w	1675,60 3120w
EH 280	€	342,40 224w	443,40 448w	546,10 672w	647,40 896w	750,20 1120w	851,00 1344w	953,90 1568w	1055,50 1792w	1156,10 2016w	1259,10 2240w	1358,90 2464w	1461,60 2688w	1562,60 2912w	1665,10 3136w	1766,50 3360w
EH 300	€	364,40 240w	474,20 480w	585,20 720w	694,30 960w	804,40 1200w	914,30 1440w	1025,40 1680w	1135,20 1920w	1244,30 2160w	1353,90 2400w	1464,00 2640w	1575,20 2880w	1685,00 3120w	1793,90 3360w	1903,80 3600w

Δt different from 50 K: consult Technical data Brem

Mod. Egon horizontal manifold height cm number elements
EH 200 - 7 EL

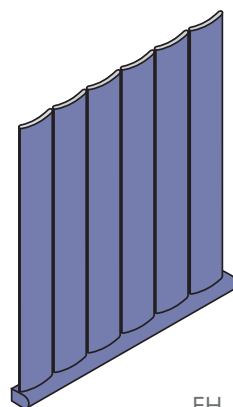

EH

PRODUCTION ON REQUEST

Height of plate every 10 cm: thermal output and prices can be obtained by interpolation

Made-to-measure (± 3 mm)

Thermal output by interpolation:

Sizes over 15 el. and 3 m: price on request

Height per cm: increased size +20%

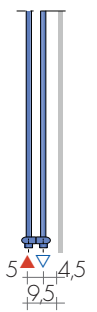

DOUBLE VERSIONS EDH

Is obtained by joining two plates EH
EDH price EH x 2 + 134,50€

Standard EG fitting (delivery on left, at front; return on right, at rear).

Thermal output EDH: single radiator x 1,60

EN 442 Watt Δt 50K (Δt 40K = Wx0,755) - (Δt 30K = Wx0,526)

MOD.	L cm	60	80	100	120	140	160	180	200	220	240	260	280	300
H cm	▲▼ cm	57,8	77,8	97,8	117,8	137,8	157,8	177,8	197,8	217,8	237,8	257,8	277,8	297,8
EV 1el. H 8,0	€	164,30 50w	189,10 66w	203,80 83w	223,80 100w	233,30 116w	250,80 133w	266,70 149w	282,90 166w	292,90 183w	312,60 199w	327,40 216w	342,40 232w	364,40 249w
EV 2el. H 15,7	€	207,20 100w	238,30 133w	257,90 166w	280,40 199w	295,50 232w	321,30 266w	342,40 299w	362,20 332w	380,70 365w	404,10 398w	422,40 432w	443,40 465w	474,20 498w
EV 3el. H 23,5	€	250,80 149w	289,10 199w	314,00 249w	338,50 299w	358,50 349w	392,80 398w	417,50 448w	439,70 498w	465,50 548w	494,10 598w	520,00 647w	546,10 697w	585,20 747w
EV 4el. H 31,2	€	292,90 199w	338,50 266w	367,90 332w	395,20 398w	419,00 465w	464,40 531w	494,10 598w	518,30 664w	552,40 730w	585,20 797w	616,40 863w	647,40 930w	694,30 996w
EV 5el. H 39,0	€	336,10 249w	387,90 332w	422,40 415w	454,70 498w	481,60 581w	535,90 664w	569,50 747w	597,10 830w	640,10 913w	674,70 996w	711,60 1079w	750,20 1162w	804,40 1245w
EV 6el. H 46,7	€	379,30 299w	437,60 398w	478,40 498w	511,20 598w	543,80 697w	607,70 797w	644,90 896w	674,70 996w	726,50 1096w	766,20 1195w	808,10 1295w	851,00 1394w	914,30 1494w
EV 7el. H 54,5	€	420,00 349w	487,10 465w	533,80 581w	569,50 697w	604,40 813w	679,50 930w	720,40 1046w	753,60 1162w	811,80 1278w	856,50 1394w	904,40 1511w	953,90 1627w	1025,40 1743w
EV 8el. H 62,2	€	463,60 398w	535,90 531w	589,60 664w	626,40 797w	667,20 930w	751,10 1062w	797,10 1195w	831,30 1328w	899,40 1461w	947,70 1594w	1002,20 1726w	1055,50 1859w	1135,20 1992w
EV 9el. H 70,0	€	506,90 448w	587,10 598w	644,10 747w	684,40 896w	728,70 1046w	822,60 1195w	872,40 1345w	910,40 1494w	985,70 1643w	1037,70 1793w	1096,90 1942w	1156,10 2092w	1244,30 2241w
EV 10el. H 77,7	€	548,40 498w	636,50 664w	698,40 830w	742,70 996w	791,80 1162w	893,40 1328w	947,70 1494w	988,60 1660w	1072,20 1826w	1129,00 1992w	1193,00 2158w	1259,10 2324w	1353,90 2490w
EV 11el. H 85,5	€	592,30 548w	684,40 730w	753,60 913w	800,40 1096w	852,30 1278w	964,80 1461w	1023,10 1643w	1067,40 1826w	1160,00 2009w	1219,10 2191w	1289,90 2374w	1358,90 2556w	1464,00 2739w
EV 12el. H 93,3	€	633,20 598w	733,90 797w	808,10 996w	857,60 1195w	914,30 1394w	1036,70 1594w	1098,30 1793w	1145,50 1992w	1245,40 2191w	1310,80 2390w	1385,00 2590w	1461,60 2789w	1575,20 2988w
EV 13el. H 101,0	€	677,20 647w	783,20 863w	863,60 1079w	915,30 1295w	977,10 1511w	1108,60 1726w	1173,80 1942w	1223,20 2158w	1331,70 2374w	1401,50 2590w	1482,40 2805w	1562,60 3021w	1685,00 3237w
EV 14el. H 108,8	€	719,40 697w	833,10 930w	918,00 1162w	973,70 1394w	1037,70 1627w	1178,40 1859w	1250,40 2092w	1302,00 2324w	1419,70 2556w	1492,40 2789w	1578,80 3021w	1665,10 3254w	1793,90 3486w
EV 15el. H 116,5	€	761,00 747w	883,50 996w	973,70 1245w	1031,60 1494w	1100,00 1743w	1251,90 1992w	1326,10 2241w	1380,30 2490w	1505,70 2739w	1582,60 2988w	1675,60 3237w	1766,50 3486w	1903,80 3735w

Δt different from 50 K: consult Technical data Brem

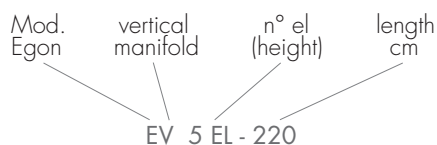

PRODUCTION ON REQUEST

Height of plate every 10 cm: thermal index and prices can be obtained by interpolation

Made-to-measure (± 3 mm)

Thermal output by interpolation

Sizes over 15 elements and 3 m: price on request

Length for cm: increased size +20%

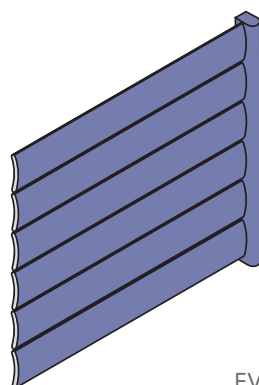

EV

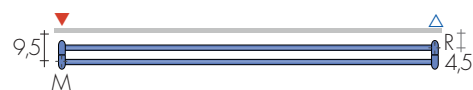

DOUBLE VERSION EDV

Is obtained by joining two plates EV
EDV price EV x 2 + 134,50€

Standard EG fitting (delivery on left, at front; return on right, at rear).

Thermal output EDV: single radiator x1,70

LAMINA-LAH

A radiating plate with bevelled side and upper edges making its already thin profile

(2,2 cm) even more imperceptible and fleeting. Created in vertical and horizontal

models, it is also available in a "Double" version with square radiating tubes at the rear.

DIMENSIONS

Width: from 28 to 81 cm, every 7 cm
 Heights: from 169 to 229 cm every 20 cm
 Depth: 5,2 / 7,2 cm
 Depth from wall: 8,2 / 8,7 cm

MODEL LAH e LADH, Vertical panel

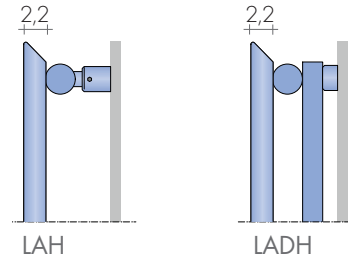
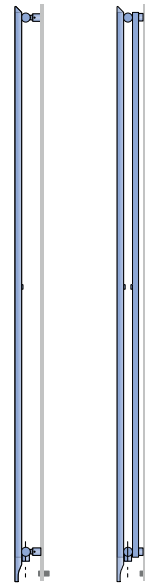
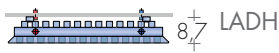
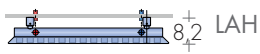

Top and side edges of the panels

As standard, the LAMINA panels is produced with hidden fittings to be mounted with side control valves. On request it is built lower H-7,5 cm to be mounted with visibles valves or with remote fittings.

LAH LADH

LAH LADH

EN 442 watt Δt 50K (Δt 40K = $w \times 0,753$) - (Δt 30K = $w \times 0,524$)

MODEL'25	L cm	32	39	46	53	60	67	74	81	88
H cm	Δ cm	14	21	28	35	42	49	56	63	70
LAH 170	€	845,00	922,30	999,80	1077,10	1154,40	1231,90	1309,40	1386,60	1463,90
H 169,5		567w	708w	850w	991w	1133w	1275w	1416w	1558w	1700w
LADH 170	€	1101,50	1195,60	1289,70	1383,40	1477,50	1571,60	1665,60	1759,60	1853,70
		787w	997w	1206w	1416w	1625w	1835w	2044w	2254w	2464w
LAH 190	€	897,00	978,20	1059,60	1141,00	1222,30	1303,60	1385,10	1466,30	1547,60
H 189,5		634w	792w	951w	1109w	1268w	1426w	1584w	1743w	1902w
LADH 190	€	1172,00	1270,40	1369,10	1467,50	1566,10	1664,80	1763,20	1861,80	1960,30
		882w	1117w	1352w	1586w	1821w	2056w	2291w	2525w	2759w
LAH 210	€	949,10	1034,30	1119,70	1205,00	1290,20	1375,60	1460,90	1546,10	1631,40
H 209,5		701w	876w	1051w	1227w	1402w	1577w	1752w	1928w	2104w
LADH 210	€	1242,50	1345,50	1448,60	1551,50	1654,60	1757,60	1860,70	1963,60	2066,50
		977w	1237w	1497w	1757w	2017w	2277w	2537w	2797w	3057w
LAH 230	€	1000,90	1090,20	1179,60	1268,80	1358,10	1447,30	1536,60	1625,80	1715,10
H 229,5		768w	960w	1152w	1344w	1536w	1728w	1920w	2112w	2304w
LADH 230	€	1312,90	1420,50	1528,00	1635,60	1743,20	1850,70	1958,20	2065,70	2173,20
		1072w	1357w	1642w	1928w	2213w	2498w	2784w	3069w	3354w

Δt different from 50 K: consult Technical data Brem

HOW TO ORDER

State: model, (LAH indicates vertical), height and width in cm; fitting and color if different from standard
 e.g.: LAH 210 - 46, EG \varnothing 1/2", RAL 3005

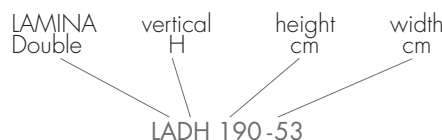

MAGNETIC ACCESSORIES pag. 277

STANDARD PRODUCTION

White sablé SB9016 paintwork, brackets white
 Air vent \varnothing 1/2" - Tolerance \pm 3 mm
 Maximum operating pressure 6 bar

PRODUCTION ON REQUEST

Paintwork to Brem color list with colored brackets
 +15/25%
 BICOLOR coloring page 99

STANDARD FITTINGS

EG \varnothing 1/2"
 Special fitting page 278
 Electric Electric version not available



TAPPING CENTRES

MODEL LAH e LADH, Vertical panel

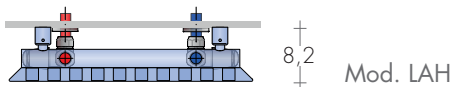
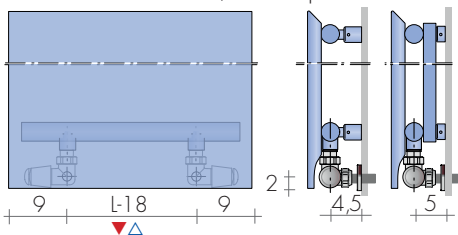

Mod. LAH

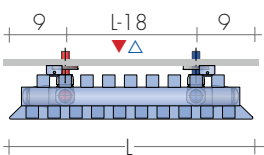

Mod. LADH



Lamina LADH BICOLOR

*BICOLOR SOLUTION Cover in a Brem color. Side and back in white to fit into the wall.

FIXINGS

Brackets included

Mod. brackets	a	b	c
LAH G30	7,2	3,7	9,2
LADH B15	7,2	3,7	9,2

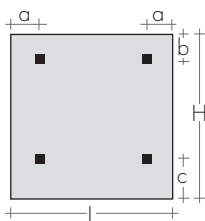

RECOMMENDED VALVES

CHROME VALVES KIT with:

- n°2 Valves with tailpieces
- n°2 Fittings (multilayer ø 16, copper ø 12, 14)
- n°2 Chrome wall plates ø 48, hole ø 16

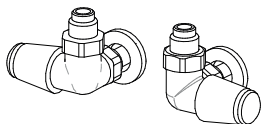

SIDE CONTROL TON VALVES KIT nickel-plated chrome-plated handwheel Art. KVLN 104,80€

SIDE CONTROL TON VALVES KIT chrome page 269 Art. KVL 150,50€

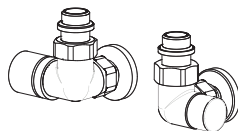

SIDE CONTROL CYL Valves KIT with THERMOSTATIC option, page 273 Art. KCLD 162,50€
Extra for BREM color list 53,40€

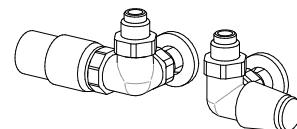

SIDE CONTROL TON Valves KIT nickel-plated with thermostatic Head Art. KTLND 161,10€

SIDE CONTROL TON VALVES KIT chrome with thermostatic Head, p.269 Art. KTLD 203,70€



LAMINA LAH210-53

SPECIAL FINISHES: Gold, Bronze, brushed Nickel, gilden/silver leaf for 2 valves page 267
Brushed Nickel FITTING KIT extra Art. RN 30,50€

*BICOLOR SOLUTION:
BIC10 Cover in a Brem color and back radiator white sablé SB9016 +10%
BIC20 Cover in a Brem color and back radiator black sablé SB9005 or grey sablé SB7039 +20%
BIC35 N° 2 Brem colors of your choice +35%

LAMINA-LAV

Horizontal version of LAMINA panel made with the exclusive tapered edge that makes

it unique. It is also designed in the "Double" version with square radiant tubes on the

back and to hide the valves with which it is connected to the heating system.

DIMENSIONS

Lengths: from 54 to 204 cm
 Heights: from 58,5 to 86,5 cm
 Depth: 5,2 / 7,2 cm
 Depth from wall: 8,2 / 8,7 cm

MODEL LAV e LADV, Horizontal panel

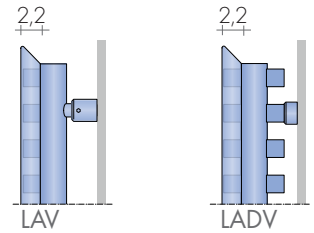

Top and side edges of the panels

LV Horizontal panel and vertical manifolds



LLV Horizontal panel with double tubes

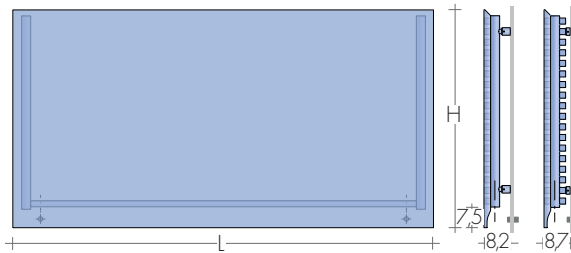
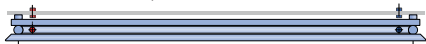

As standard, the LAMINA panels is produced with hidden fittings to be mounted with side control valves. On request it is built lower H-7,5 cm to be mounted with visibles valves or with remote fittings.

EN 442 Watt Δt 50K (Δt 40K = Wx0,755) - (Δt 30K = Wx0,526)

MODEL	L cm	54	64	74	84	94	104	124	144	164	184	204
LAV 59	H 58,5	€ 820,50 349w	862,40 408W	904,30 468w	946,50 528w	988,30 587w	1030,20 647w	1072,10 766w	1114,00 885w	1156,00 1004w	1197,90 1123w	1239,90 1242w
LADV 59	H 58,5	€ 1035,00 499w	1093,60 589w	1152,00 678w	1210,70 768w	1269,30 858w	1327,80 947w	1386,30 1126w	1444,90 1305w	1503,50 1485w	1562,10 1664w	1620,50 1843w
LAV 66	H 65,5	€ 857,90 399w	902,80 467W	947,80 535w	992,90 603w	1037,70 671w	1082,70 739w	1127,60 875w	1172,60 1012w	1217,60 1148w	1262,50 1284w	1307,50 1420w
LADV 66	H 65,5	€ 1099,20 571w	1164,00 673w	1228,80 775w	1293,70 878w	1358,60 981w	1423,30 1083w	1488,30 1287w	1553,10 1492w	1618,00 1697w	1682,80 1902w	1747,50 2107w
LAV 73	H 72,5	€ 895,20 449w	943,20 525w	991,20 602w	1039,20 678w	1087,10 755w	1135,20 831w	1183,10 984w	1231,10 1138w	1279,20 1291w	1327,10 1444w	1375,10 1597w
LADV 73	H 72,5	€ 1163,20 642w	1234,40 757w	1305,50 872w	1376,60 987w	1447,70 1103w	1518,80 1218w	1590,10 1448w	1661,20 1678w	1732,30 1909w	1803,40 2139w	1874,50 2370w
LAV 80	H 79,5	€ 943,20 499w	995,60 584w	1047,70 669w	1099,80 754w	1152,10 839w	1204,40 924w	1256,50 1094w	1308,70 1264w	1360,90 1434w	1413,00 1604w	1465,30 1774w
LADV 80	H 79,5	€ 1202,70 713w	1277,40 841w	1352,10 969W	1426,70 1097w	1501,40 1225w	1576,20 1353w	1650,70 1609w	1725,60 1865w	1800,20 2121w	1874,70 2377w	1949,60 2633w
LAV 87	H 86,5	€ 991,10 549W	1047,80 643W	1104,10 736W	1160,40 830W	1216,90 923W	1273,50 1017W	1329,80 1204V	1386,20 1390W	1442,60 1577W	1498,80 1764W	1555,60 1951W
LADV 87	H 86,5	€ 1242,10 784W	1320,30 925W	1398,70 1066W	1476,70 1207W	1554,90 1347W	1633,40 1488W	1711,20 1770W	1789,90 2052W	1867,90 2333W	1945,90 2615W	2024,60 2896W

Δt different from 50 K: consult Technical data Brem

HOW TO ORDER

State: model, (L indicates panel vertical), height and width in cm; fitting and color if different from standard
 e.g.: LAV 66 - 124, EG \varnothing 1/2", RAL 3005

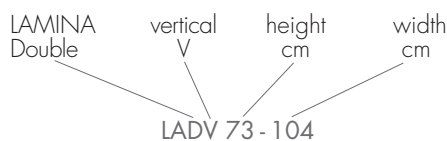

STANDARD PRODUCTION

White sablé SB9016 paintwork, brackets white
 Air vent \varnothing 1/2" - Tolerance \pm 3 mm
 Maximum operating pressure 6 bar

PRODUCTION ON REQUEST

Paintwork to Brem list with colored brackets
 +15/25%
 BICOLOR coloring page 101

STANDARD FITTINGS

EG \varnothing 1/2"
 Special fitting page 279 Electric
 Electric version not available

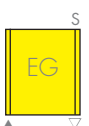

TAPPING CENTRES

EG standard fittings, use side control valves

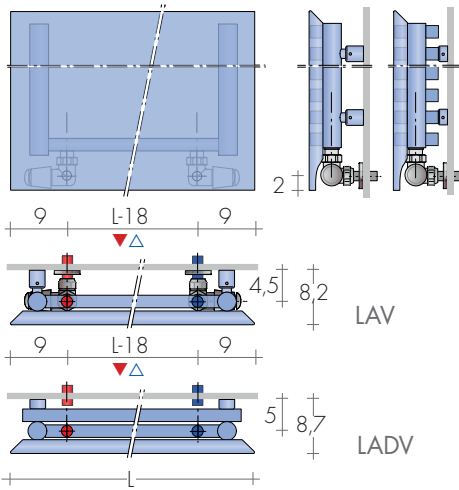

FIXINGS

Brackets included

Mod. brachets	a	b	c
LAV G30	3,7	7,2	12,7
LADV B15	3,7	7,2	12,7

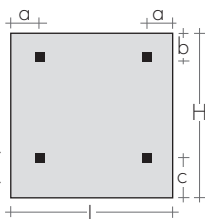

RECOMMENDED VALVES

CHROME VALVES KIT with:

- n°2 Valves with tailpieces
- n°2 Fittings (multilayer ø 16, copper ø 12, 14)
- n°2 Chrome wall plates ø 48, hole ø 16

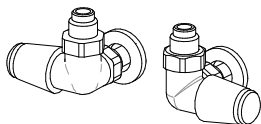

SIDE CONTROL TON VALVES KIT nickel-plated chrome-plated handwheel Art. KVLN 104,80€
SIDE CONTROL TON chrome VALVES KIT page 269 Art. KVL 150,50€

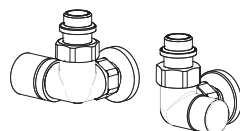

SIDE CONTROL CYL Valves KIT with THERMOSTATIC option, page 273 Art. KCLD 162,50€
Extra for BREM color list 53,40€

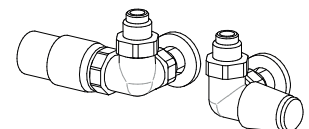

SIDE CONTROL TON Valves KIT nickel-plated with thermostatic Head Art. KTLND 161,10€
SIDE CONTROL TON VALVES KIT chrome with thermostatic Head, p.269 Art. KTLD 203,70€



OPEN-H

OPEN is a panel with flattened tubes that are welded to the manifolds placed at the rear to create a perfectly flat radiating surface

with radiating tubes providing movement. OPEN panel can be either vertical, single or double and with fins at the rear.

Heights: from 60 to 240 cm
 Lengths: from 28,9 to 93,2 cm (n° el. x 7,15 + 0,25)
 Depths: 4,3 / 6 / 5,3 cm
 Depths from wall: 6,8 / 7,5 cm



OH
Vertical plate and horizontal manifolds



OLH
Vertical plate with fins



OH2
Double vertical plate

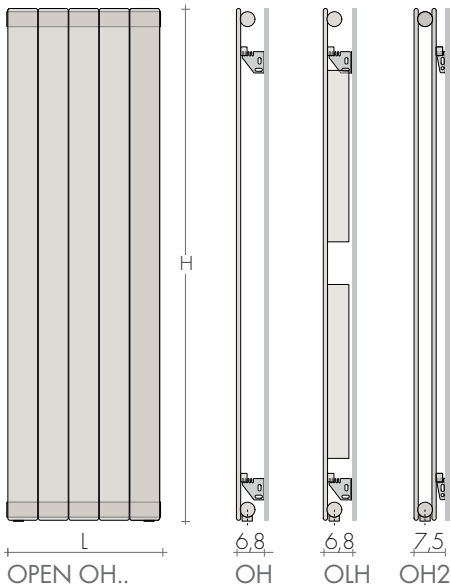

TAPPING CENTRES

EG vertical fittings as standard
 Side fittings on request without extra

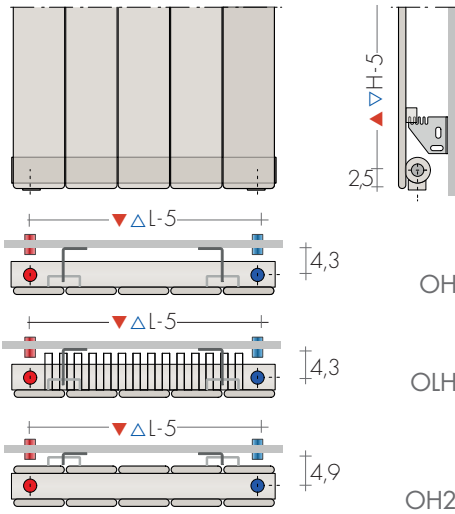

HOW TO ORDER

State: model, (L indicates fins), height in cm, n° of elements; fitting and color if different from standard
 e.g.: OLH 180-7e, EG ø 1/2", RAL 3005

HEIGHTS ON REQUEST

Heights of plate every 10 cm:
 - thermal outputs and prices by interpolation
 Heights of plate on request every 1 cm:
 - thermal outputs by interpolation
 - prices: price increased size +20%

STANDARD PRODUCTION

White "sablé" paintwork - EOS brackets
 Air vent ø 1/2" - Tolerance ± 3 mm
 Maximum Operating pressure 6 bar

PRODUCTION ON REQUEST

Paintwork to Brem color list up to 3 m with colored brackets +15/25%
 Made-to measure dimensions, on request

FIXINGS

Brackets included



EOS bracket

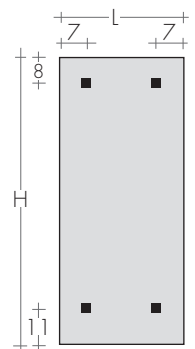

STANDARD FITTINGS EG ø 1/2"

AC or BD Fittings on request
 Special fittings page 278



MOD. H cm	n°el. L cm	EN 442 Watt Δt 50K (Δt 40K = $W \times 0,755$) - (Δt 30K = $W \times 0,526$)									
		4	5	6	7	8	9	10	11	12	13
	▲▼ cm	28,9	36	43,2	50,3	57,5	64,6	71,8	78,9	86,1	93,2
		23,9	31	38,2	45,3	52,5	59,6	66,8	73,9	81,1	88,2
OH 60	€	250,70 184w	284,80 230w	319,10 276w	353,10 322w	387,30 368w	421,30 414w	455,60 460w	489,70 506w	523,80 552w	558,10 598w
OLH 60	€	382,70 284w	418,90 355w	454,70 426w	490,80 497w	526,70 568w	562,70 639w	598,60 710w	634,50 781w	670,70 852w	706,50 923w
OH2 60	€	603,50 268w	671,90 335w	740,50 402w	809,30 469w	877,90 536w	946,50 603w	1015,30 670w	1083,80 737w	1152,60 804w	1221,10 871w
OH 80	€	275,50 240w	314,30 300w	352,90 360w	391,70 420w	430,10 480w	468,70 540w	507,50 600w	546,00 660w	584,80 720w	623,40 780w
OLH 80	€	447,70 352w	490,40 440w	533,00 528w	575,70 616w	618,50 704w	661,00 792w	703,80 880w	746,40 968w	789,20 1056w	831,80 1144w
OH2 80	€	653,00 348w	730,60 435w	808,20 522w	885,80 609w	963,60 696w	1041,30 783w	1118,90 870w	1196,50 957w	1274,20 1044w	1351,80 1131w
OH 100	€	300,60 296w	343,60 370w	386,70 444w	429,90 518w	472,90 592w	516,00 666w	559,10 740w	602,20 814w	645,20 888w	688,50 962w
OLH 100	€	562,10 420w	612,20 525w	662,40 630w	712,40 735w	762,30 840w	812,20 945w	862,50 1050w	912,40 1155w	962,30 1260w	1012,60 1365w
OH2 100	€	703,00 428w	789,60 535w	876,20 642w	962,80 749w	1049,30 856w	1136,00 963w	1222,70 1070w	1309,40 1177w	1396,00 1284w	1482,50 1391w
OH 160	€	377,80 464w	434,10 580w	490,00 696w	546,20 812w	602,60 928w	658,70 1044w	714,80 1160w	771,00 1276w	827,20 1392w	883,50 1508w
OLH 160	€	686,30 612w	752,50 765w	818,30 918w	884,40 1071w	950,30 1224w	1016,30 1377w	1082,30 1530w	1148,30 1683w	1214,20 1836w	1280,30 1989w
OH2 160	€	853,00 664w	965,80 830w	1078,60 996w	1191,50 1162w	1304,50 1328w	1417,20 1494w	1530,10 1660w	1642,90 1826w	1755,90 1992w	1868,70 2158w
OH180	€	400,80 520w	461,30 650w	521,60 780w	582,00 910w	642,30 1040w	702,70 1170w	762,90 1300w	823,50 1430w	883,90 1560w	944,20 1690w
OLH 180	€	728,30 676w	797,30 845w	866,30 1014w	935,60 1183w	1004,60 1352w	1073,70 1521w	1143,00 1690w	1212,00 1859w	1281,10 2028w	1350,30 2197w
OH2 180	€	902,80 740w	1024,00 925w	1145,30 1110w	1266,60 1295w	1387,80 1480w	1509,20 1665w	1630,40 1850w	1751,70 2035w	1872,90 2220w	1994,20 2405w
OH 200	€	425,60 576w	490,40 720w	555,30 864w	620,00 1008w	684,80 1152w	749,70 1296w	814,50 1440w	879,30 1584w	944,20 1728w	1009,00 1872w
OLH 200	€	833,10 740w	913,50 925w	994,30 1110w	1074,90 1295w	1155,30 1480w	1236,00 1665w	1316,70 1850w	1397,20 2035w	1477,70 2220w	1558,50 2405w
OH2 200	€	952,80 820w	1082,90 1025w	1213,30 1230w	1343,30 1435w	1473,60 1640w	1603,80 1845w	1734,00 2050w	1864,20 2255w	1994,40 2460w	2124,60 2665w
OH 220	€	450,70 632w	520,00 790w	589,30 948w	658,60 1106w	728,00 1264w	797,20 1422w	866,30 1580w	935,90 1738w	1005,10 1896w	1074,30 2054w
OLH 220	€	901,70 804w	991,20 1005w	1081,00 1206w	1170,60 1407w	1260,30 1608w	1350,00 1809w	1439,60 2010w	1529,20 2211w	1618,80 2412w	1708,60 2613w
OH2 220	€	1000,40 896w	1139,40 1120w	1278,10 1344w	1417,10 1568w	1556,00 1792w	1694,90 2016w	1833,80 2240w	1972,80 2464w	2111,40 2688w	2250,40 2912w
OH 240	€	475,80 688w	549,60 860w	623,20 1032w	696,90 1204w	770,90 1376w	844,60 1548w	918,30 1720w	992,00 1892w	1065,80 2064w	1139,70 2236w
OH2 240	€	1048,20 972w	1195,70 1215w	1343,20 1458w	1490,90 1701w	1638,30 1944w	1786,00 2187w	1933,30 2430w	2081,10 2673w	2228,40 2916w	2376,10 3159w

Δt different from 50 K: consult Technical data Brem

RECOMMENDED VALVES

CHROME VALVES KIT with:

- n°2 Valves with chrome tailpieces
- n°2 Fittings (multilayer $\phi 16$, copper $\phi 12$, 14)
- n°2 Chrome wall plates $\phi 48$, hole $\phi 16$

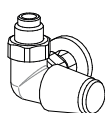

SPECIAL FINISHES

page 267
Finishes Gold, Bronze, Brushed Nickel for 2 valves
Brushed Nickel FITTING KIT extra Art. RN 30,50€

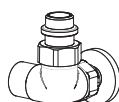

REMOTE FITTINGS

Art. REM 42,10€
Tapping centres: at the rear of radiator ▲▼ EG L - 5 cm
DISTANT Valves page 274

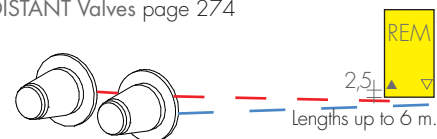

SIDE CONTROL TON Valves KIT
page 269

Art. KVL 150,50€

SIDE CONTROL CYL Valves KIT with THERMO-
STATIC option, page 273 Art. KCL 162,50€
Extra for BREM color list 53,40€

SIDE CONTROL TON Valves KIT with thermostatic
Head, p.269 Art. KTL 203,70€

OPEN-V

OPEN is a panel with flattened tubes that are welded to the manifolds placed at the

rear to create a perfectly flat radiating surface with radiating tubes providing movement.

OPEN panel can be either horizontal single or double and with fins at the rear.

Heights: from 50,3 to 93,32cm (from 7 to 13 el.)

Lengths: from 50 to 220 cm

Depths: 4,3 / 6 / 5,3 cm

Depths from wall: 6,8 / 7,5 cm

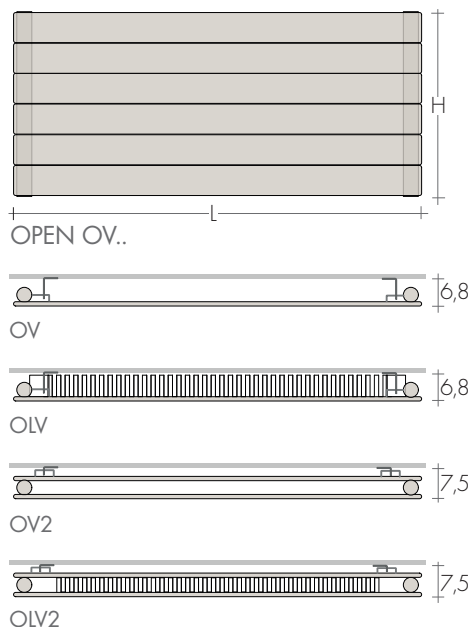

MODELLO	L cm	EN 442 Watt Δt 50K (Δt 40K = $W \times 0,755$) - (Δt 30K = $W \times 0,526$)											
		50	60	70	80	90	100	120	140	160	180	200	220
OV 7 el	50,3	338,60 264w	357,50 316w	376,30 369w	395,40 422w	414,30 474w	433,20 527w	471,00 632w	508,70 738w	546,60 843w	584,30 949w	622,30 1054w	660,10 1159w
OLV 7 el		477,80 431w	510,30 517w	542,60 603w	575,10 689w	607,60 775w	640,10 861w	704,90 1033w	769,80 1205w	834,70 1378w	899,70 1550w	964,40 1722w	1029,30 1894w
OV2 7 el		779,30 415w	816,70 498w	854,30 581w	891,70 664w	929,20 747w	966,60 830w	1041,50 996w	1116,40 1162w	1191,30 1328w	1266,30 1494w	1341,20 1660w	1416,00 1826w
OLV2 7 el		879,60 535w	925,80 642w	971,70 749w	1017,70 856w	1063,70 963w	1109,90 1070w	1202,00 1284w	1294,00 1498w	1386,20 1712w	1478,30 1926w	1570,40 2140w	1662,50 2354w
OV 9 el	64,6	394,10 333w	417,10 399w	440,40 466w	463,60 532w	486,80 599w	510,00 665w	556,30 798w	602,70 931w	648,90 1064w	695,40 1197w	741,80 1330w	788,00 1463w
OLV 9 el		529,50 540w	567,10 648w	604,70 756w	642,30 864w	680,10 972w	717,70 1080w	793,00 1296w	868,20 1512w	943,50 1728w	1018,90 1944w	1094,10 2160w	1169,40 2376w
OV2 9 el		891,20 519w	937,00 623w	983,10 727w	1029,20 830w	1075,20 934w	1121,30 1038w	1213,40 1246w	1305,50 1453w	1397,60 1661w	1489,60 1868w	1581,90 2076w	1674,10 2284w
OLV2 9 el		1014,20 645w	1073,90 774w	1133,60 903w	1192,90 1032w	1252,70 1161w	1312,30 1290w	1431,50 1548w	1550,60 1806w	1669,90 2064w	1789,20 2322w	1908,30 2580w	2027,60 2838w
OV 10 el	71,8	431,00 367w	457,00 440w	482,80 514w	508,70 587w	534,70 661w	560,70 734w	612,80 881w	664,60 1028w	716,50 1174w	768,40 1321w	820,40 1468w	872,40 1615w
OLV 10 el		566,50 595w	607,00 713w	647,20 832w	687,60 951w	728,20 1070w	768,50 1189w	849,40 1427w	930,00 1665w	1010,90 1902w	1091,70 2140w	1172,60 2378w	1253,40 2616w
OV2 10 el		964,40 571w	1016,00 685w	1067,60 799w	1119,20 914w	1170,60 1028w	1222,30 1142w	1325,40 1370w	1428,60 1599w	1531,60 1827w	1634,90 2056w	1738,00 2284w	1841,20 2512w
OLV2 10 el		1052,10 700w	1117,20 840w	1182,50 980w	1247,60 1120w	1312,60 1260w	1377,80 1400w	1508,10 1680w	1638,30 1960w	1768,60 2240w	1898,70 2520w	2029,00 2800w	2159,20 3080w
OV 12 el	86,1	502,20 436w	532,30 523w	562,70 610w	592,90 698w	623,20 785w	653,50 872w	714,10 1046w	774,50 1221w	835,20 1395w	895,70 1570w	956,40 1744w	1016,80 1918w
OLV 12 el		639,40 704w	684,40 844w	729,20 985w	774,10 1126w	819,20 1266w	863,90 1407w	953,60 1688w	1043,50 1970w	1133,20 2251w	1222,90 2533w	1312,60 2814w	1402,40 3095w
OV2 12 el		1107,70 675w	1167,80 810w	1228,00 945w	1288,30 1080w	1348,50 1215w	1408,80 1350w	1529,20 1620w	1649,80 1890w	1770,30 2160w	1890,80 2430w	2011,00 2700w	2131,50 2970w
OLV2 12 el		1166,40 810w	1242,20 972w	1318,10 1134w	1394,10 1296w	1469,80 1458w	1545,70 1620w	1697,60 1944w	1849,10 2268w	2000,80 2592w	2152,60 2916w	2304,30 3240w	2456,00 3564w
OV 13 el	93,2	533,10 471w	565,70 565w	598,30 659w	631,00 753w	663,60 847w	696,20 941w	761,50 1129w	826,60 1317w	892,00 1506w	957,20 1694w	1022,40 1882w	1087,60 2070w
OV2 13 el		1169,50 727w	1234,50 872w	1299,30 1018w	1364,30 1163w	1429,30 1309w	1494,10 1454w	1623,90 1745w	1753,80 2036w	1883,60 2326w	2013,40 2617w	2143,20 2908w	2273,30 3199w

STANDARD PRODUCTION

White "sablé" paintwork - EOS brackets
Air vent \varnothing 1/2" - Tolerance \pm 3 mm
Maximum Operating pressure 6 bar

PRODUCTION ON REQUEST

Paintwork to Brem color list up to 3 m with
colored brackets +15/25%
Made-to measure dimensions, on request

STANDARD FITTINGS EG \varnothing 1/2"

AC or BD Fittings on request
Special fittings page 278



TAPPING CENTRES

EG vertical fittings as standard
Side fittings on request without extra

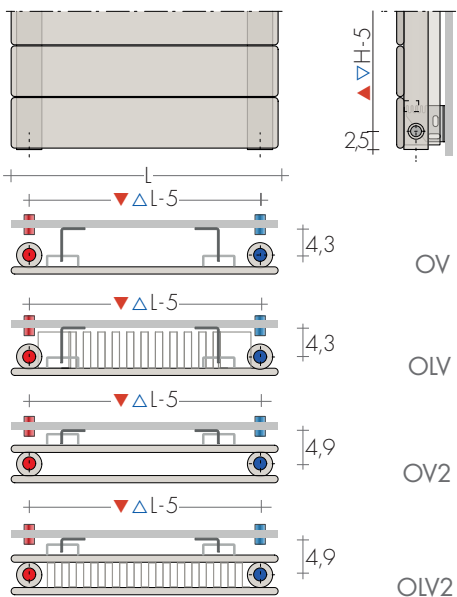

OLV fins 7 cm high less than the plate

FIXINGS

Brackets included



EOS bracket

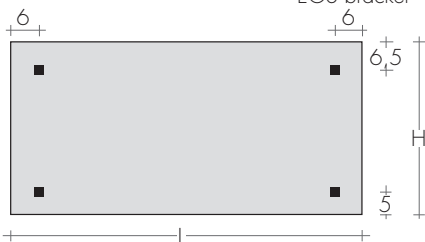

RECOMMENDED VALVES

CHROME VALVES KIT with:

- n°2 Valves with chrome tailpieces
- n°2 Fittings (multilayer ø16, copper ø12, 14)
- n°2 Chrome wall plates ø 48, hole ø16



SIDE CONTROL TON Valves KIT
page 269

Art. KVL 150,50€

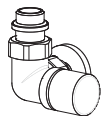

SIDE CONTROL CYL Valves KIT with THERMO-
STATIC option, page 273 Art. KCL 162,50€
Extra for BREM color list 53,40€

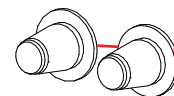

2,5
Lengths up to 6 m.

SPECIAL FINISHES page 267
Finishes Gold, Bronze, Brushed Nickel for 2 valves
Brushed Nickel FITTING KIT extra Art. RN 30,50€

REMOTE FITTINGS Art. REM 42,10€
Tapping centres: at the rear ▲▼ EG L-5 cm
DISTANT Valves page 274

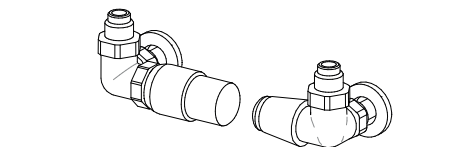

SIDE CONTROL TON Valves KIT with thermostatic
Head, p.269 Art. KTL 203,70€



OPEN OV2 4el-140

PHUL

RADIATORS & TOWEL RAILS

The PHUL with 3 bevelled sides warms up from small rooms to large spaces.

Essentiality is the most obvious theme, more over a complete set of magnetic accessories

helps in the various needs of everyday life.

DIMENSIONS

Lengths: 44/54/59 cm
 Heights: 80/96/100/120/144/160/176/200/216 cm
 Depth: 5,2 cm
 Depth from wall: 8,2 cm

On request H- 6 cm version for visible valves

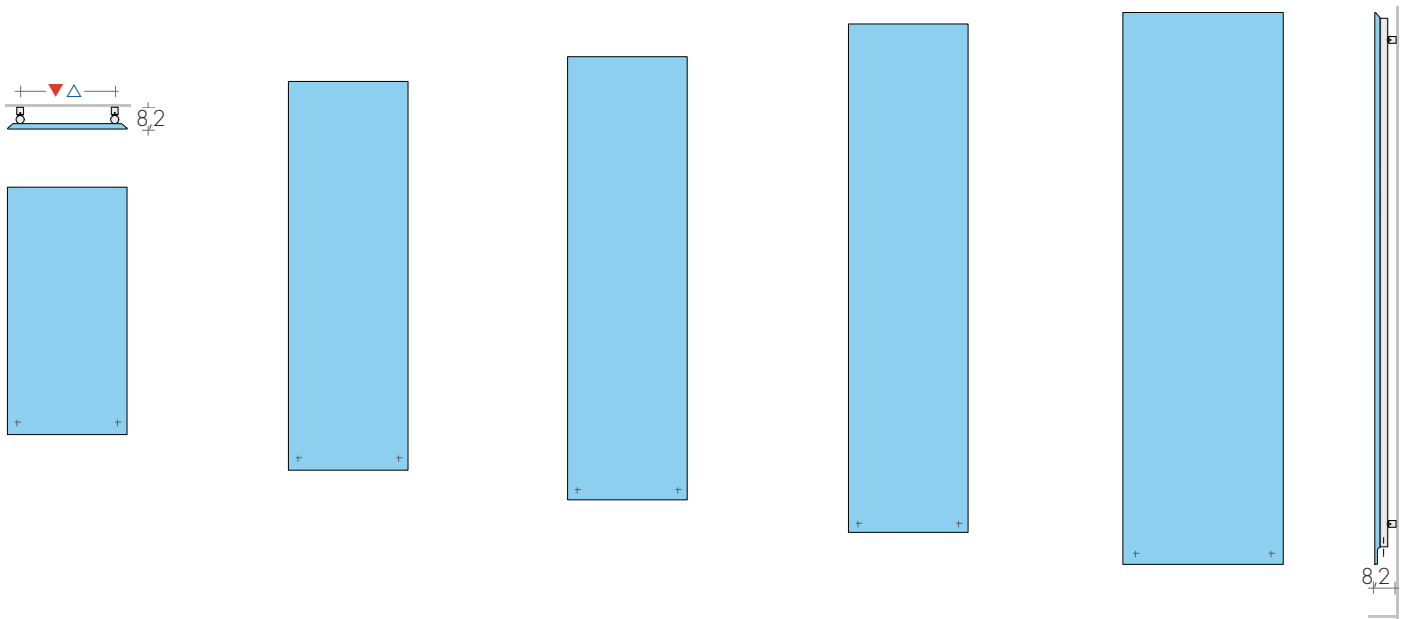

PHUL 80-..
 PHUL 96-..
 PHUL 100-..

PHUL 120-44
 PHUL 120-54

PHUL 144-44
 PHUL 160-44

PHUL 176-54
 PHUL 216-54

PHUL 200-59

MODEL	H-L cm	Standard white sablé SB 9016 €	EN 442			▲ ▽ i.c. cm	Height H cm	Width L cm	Weight M Kg	Volume V dm³	DUAL FUEL VERSION with E.H.E. and *	
			Δt 50K watt	Δt 40K watt	Δt 30K watt						Watt	€
PHUL	80-44	607,90	409	309	215	35	80,5	44	10,0	3,1	400	103,40
PHUL	80-54	667,10	492	371	259	45	80,5	54	12,0	3,7	500	105,60
PHUL	96-44	684,30	500	378	263	35	96,5	44	12,2	3,8	500	105,60
PHUL	100-54	726,30	629	475	331	45	100,5	54	15,3	4,7	650	107,80
PHUL	120-44	746,90	637	481	335	35	120,5	44	15,4	4,9	650	107,80
PHUL	120-54	795,80	765	578	402	45	120,5	54	18,5	5,8	800	112,60
PHUL	144-44	821,10	773	584	407	35	144,5	44	18,6	5,9	800	112,60
PHUL	160-44	866,40	864	652	454	35	160,5	44	20,7	6,6	900	116,20
PHUL	176-54	1077,10	1148	867	604	45	176,5	54	27,6	8,6	1200	124,50
PHUL	200-59	1256,30	1422	1074	748	50	200,5	59	34,1	10,6	1500	135,40
PHUL	216-54	1281,40	1421	1073	747	45	216,5	54	34,1	10,6	1500	135,40

*Dual fuel valve to be added p.207
 Thermostats p.208-209

RAM TOWEL-BAR

Towel holder with magnets page 277
 (35X44x7 cm) Art. RAM 172,50€



MAGNET
 Magnetic towel holder pag. 277
 (40x3,3x6,2 cm) Art. MAG40 140,60€
 (50x3,3x6,2 cm) Art. MAG50 145,00€

KNOBS
 Magnetic pag.277
 cad. 95,50€



STANDARD PRODUCTION

White sablé SB9016 paintwork, brackets white
 Air vent ø 1/2" - Tolerance ± 3 mm
 Maximum operating pressure 6 bar

PRODUCTION ON REQUEST

Paintwork to Brem color list with colored
 brackets +15/25%
 BICOLOR coloring page 107

STANDARD FITTINGS

EG ø 1/2"
 Special fitting page 279 Electric
 Electric version e. PHUL p.247

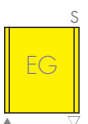

TAPPING CENTRES

EG standard fittings, use side control valves

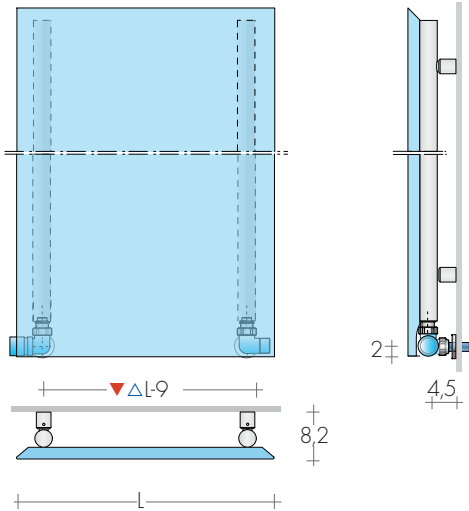

DUAL FUEL VERSION

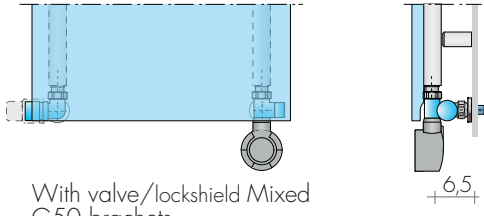

With valve/lockshield Mixed G50 brackets

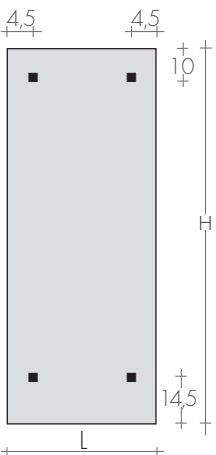

FIXINGS
G30 brackets
included



RECOMMENDED VALVES

CHROME VALVES KIT with:

- n°2 Valves with chrome tailpieces
- n°2 Fittings (multilayer ø16, copper ø12, 14)
- n°2 Chrome wall plates ø 48, hole ø16

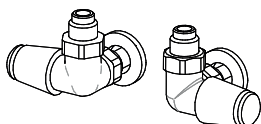

SIDE CONTROL TON VALVES KIT nickel-plated
chrome-plated handwheel Art. KVLN 104,80€
SIDE CONTROL TON chrome VALVES KIT
page 269 Art. KVL 150,50€

SPECIAL FINISHES

page 267
Finishes Gold, Bronze, Brushed Nickel for 2 valves
Brushed Nickel FITTING KIT extra Art. RN 30,50€

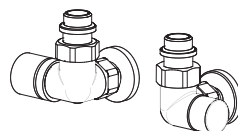

SIDE CONTROL CYL Valves KIT with THERMO-
STATIC option, page 273 Art. KCLD 162,50€
Extra for BREM color list 53,40€

BICOLOR SOLUTION:

BIC10 Cover in a Brem color and back radiator
white sablé SB9016 +10%
BIC20 Cover in a Brem color and back radiator
black sablé SB9005 or grey sablé SB7039 +20%
BIC35 N° 2 Brem colors of your choice +35%

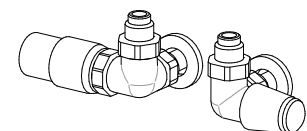

SIDE CONTROL TON Valves KIT nickel-plated with
thermostatic Head Art. KTLND 161,10€
SIDE CONTROL TON VALVES KIT chrome with
thermostatic Head, p.269 Art. KTLD 203,70€

SO-FLEX RADIATORS & TOWEL RAILS

design Gabriella Almagioni

SO-FLEX goes beyond the basic idea of a towel heater (order and folding) and

introduces a new concept: practical disorder, careless gestures and the fun of not having

to fold everything, but simply chuck a used towel into a warm shell.

DIMENSIONS

Width 45/54/63/72/120 cm

Height 63/130/180/200 cm

Depth 11 cm

Depth from wall 14 cm

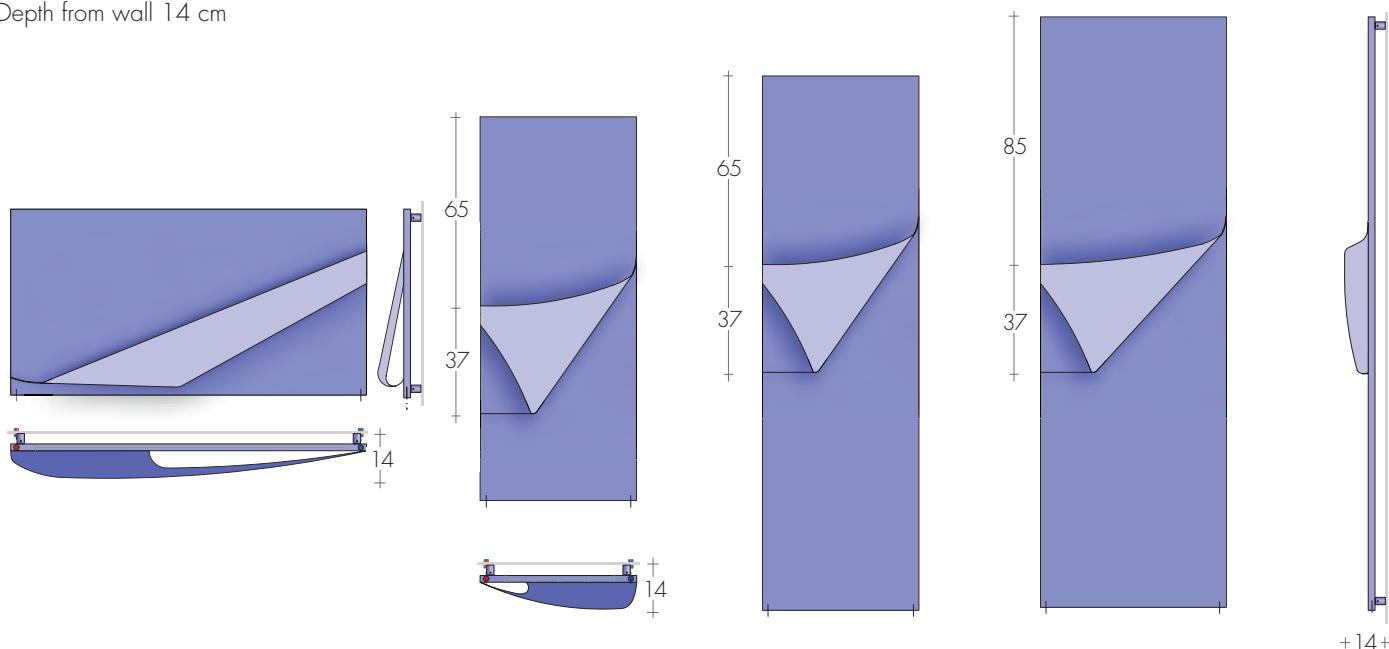

FXV 63-120

FXH 130-..

FXH/FXLH 180-..

FXH/FXLH 200-..

MODEL	H-L cm	Standard white sablé SB 9016 €	Δt 50K watt	EN 442 Δt 40K watt	Δt 30K watt	▲ ▼ t.c. cm	Height H cm	Width L cm	Weight M Kg	Volume V dm ³	Dual Fuel version with Resistance and * Watt €	
FXV	63-120	1469,40	827	626	435	117	63	120	23,5	7,1	900	116,20
FXH	130-45	1154,20	643	487	338	41	130	45	18,2	6,0	650	107,80
FXH	130-54	1228,20	770	583	405	50	130	54	21,8	6,8	800	112,60
FXH	180-45	1273,80	887	671	466	41	180	45	25,1	8,1	900	116,20
FXH	180-54	1387,70	1061	803	558	50	180	54	30,0	9,2	-	-
FXLH	180-54	1666,00	1453	1100	767	50	180	54	43,8	13,4	1500	135,40
FXH	180-63	1500,40	1233	933	648	59	180	63	34,9	10,3	1200	124,50
FXLH	180-63	1797,90	1723	1304	910	59	180	63	51,2	15,6	1500	135,40
FXH	180-72	1610,00	1407	1065	743	68	180	72	41,4	12,7	1500	135,40
FXLH	180-72	1929,50	1996	1511	1054	68	180	72	58,5	17,9	-	-
FXH	200-54	1448,00	1178	892	622	50	200	54	34,4	10,6	1200	124,50
FXH	200-63	1564,80	1369	1036	723	59	200	63	40,1	12,3	1500	135,40
FXLH	200-63	1919,30	1916	1450	1042	59	200	63	56,8	17,3	-	-
FXH	200-72	1775,30	1562	1182	825	68	200	72	45,9	14,1	1500	135,40
FXLH	200-72	2060,00	2219	1680	1172	68	200	72	64,9	19,8	-	-

*Dual fuel valve or T to be added p.207
Thermostats p.208-209

SABLE' COLORS ARE RECOMMENDED
(as they make the fold softer to the touch)

STANDARD PRODUCTION

White sablé SB9016 paintwork, brackets white
Tolerance ± 3mm - Air vent ø 1/8"

MAXIMUM OPERATING PRESSURE 4 BAR

PRODUCTION ON REQUEST

Paintwork to BREM color list
with colored brackets

Electric version, on request

+15/25%

STANDARD FITTING

EG ø 3/8"

1/2" fittings on request

Special fittings, page 279



TAPPING CENTRES EG 3/8" STANDARD
On request EG ø 1/2" without extra.

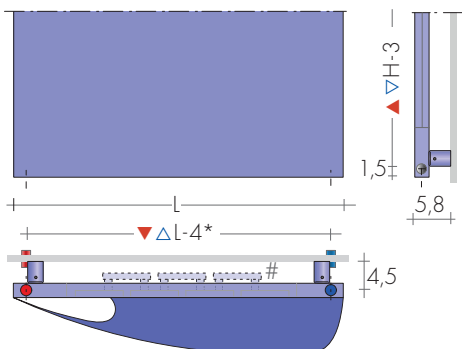

*Mod. FXV ▲▼ L-3 # Mod. FXLH: radiant tubes on the back
*Mod. FXH ▲▼ L-4

On request SIDE FITTING AC / BD ø 3/8"
or fitting ø 1/2" with sleeves
Extra per AC/BD Art. AS 91,20€

Mod. FXV 63-120 ▲▼ AC/BD H - 4 cm
Mod. FXH /FXLH ... ▲▼ AC/BD H - 3 cm



Fitting ø 3/8"
STANDARD
(without sleeves)



Fitting ø 1/2"
ON REQUEST
(with sleeves)

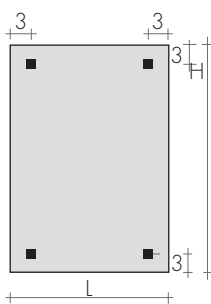

B35 FIXINGS
Brackets included



FXV 63-120

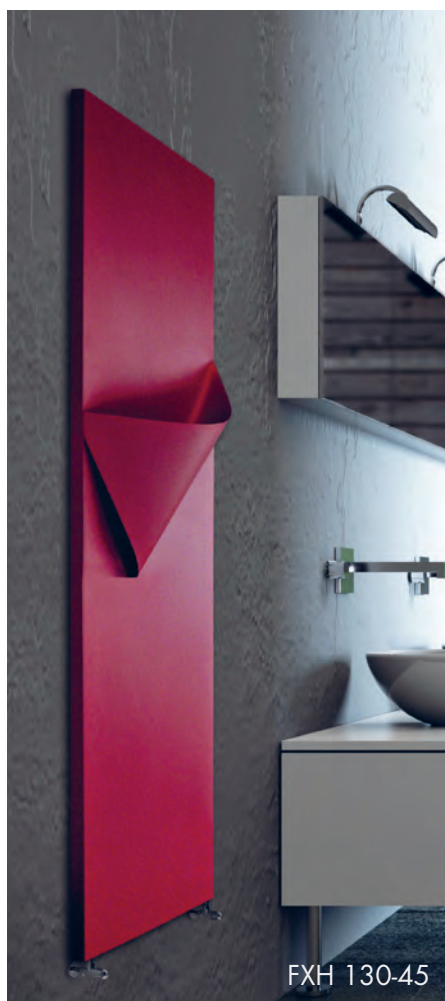

FXH 130-45



FXH 180-54

RECOMMENDED VALVES

CHROME VALVES KIT with:

- n°2 Valves with chrome tailpieces
- n°2 Fittings (multilayer ø16, copper ø12, 14)
- n°2 Chrome wall plates ø 48, hole ø16

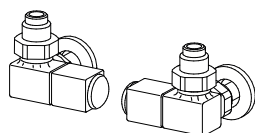

KIT SIDE control VALVES QUADRA
page 271 Art. KQL 191,20€
Extra for BREM color list 53,40€

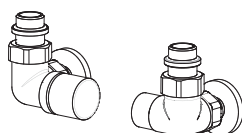

KIT SIDE control VALVES CYL with THERMOSTATIC
option, page 273 Art. KCL 162,50€
Extra for BREM color list 53,40€

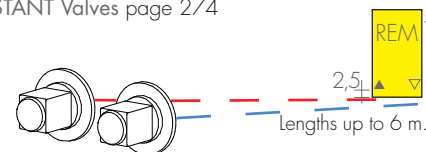

REMOTE FITTINGS Art. REM 42,10€
Tapping centres: at the rear ▲▼ EG L - 5 cm
DISTANT Valves page 274

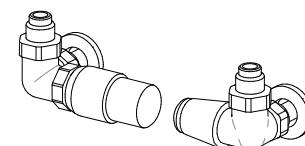

KIT SIDE control VALVES TON with Thermostatic
head, page 269 Art. KTL 203,70€

SPH - PLATT

SPH-PLATT is the radiating plate with perfectly flat and smooth surfaces: true

simplicity of form is the greatest thing. Laid vertically in the most traditional

colors SPH-PLATT jolts pure reason into the irrationality of the unexpected.

DIMENSIONS

Lengths: from 28 to 84 cm

Heights: from 160 to 240 cm (every 20 cm)

Depths: SPH 3,7 cm, SPLH 6,2 cm

Depths from wall: SPH 6,8 cm, SPLH 7,8 cm

SPH MODEL

Vertical panel

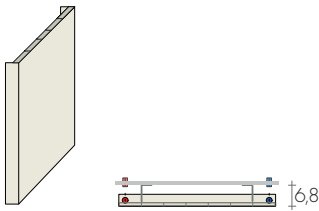

SPH

SPLH MODEL

Vertical panel with radiating fins at the rear

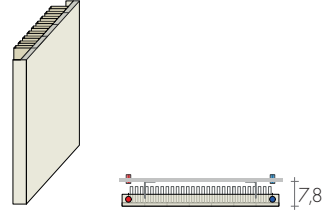

SPLH

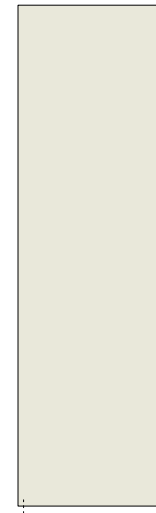

SPH ... SPLH ...



SPH

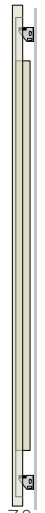

SPLH

EN 442 Watt Δt 50K (Δt 40K = $W \times 0,755$) (Δt 30K = $W \times 0,526$)

MOD.	L cm	28	35	42	49	56	63	70	77	84
H cm	▲▼	24	31	38	45	52	59	66	73	80
SPH 160	€	762,20 420w	839,60 525w	920,90 630w	1003,50 735w	1083,20 840w	1161,90 945w	1244,20 1050w	1324,20 1155w	1404,90 1260w
SPLH 160	€	993,40 629w	1096,60 786w	1200,00 943w	1304,60 1100w	1410,30 1257w	1513,70 1414w	1619,20 1572w	1722,20 1729w	1827,30 1886w
SPH 180	€	810,10 467w	894,50 584w	978,30 701w	1065,70 817w	1151,90 934w	1235,20 1051w	1322,70 1168w	1407,40 1284w	1493,70 1401w
SPLH 180	€	1046,20 689w	1153,30 861w	1250,60 1033w	1369,50 1205w	1477,50 1377w	1584,80 1549w	1693,10 1721w	1801,30 1893w	1906,90 2065w
SPH 200	€	854,00 513w	943,00 642w	1033,50 770w	1118,70 898w	1208,40 1026w	1296,70 1155w	1385,40 1283w	1476,50 1411w	1565,00 1540w
SPLH 200	€	1122,80 742w	1240,20 928w	1355,60 1113w	1481,10 1299w	1588,80 1484w	1704,60 1670w	1820,60 1855w	1934,90 2041w	2050,60 2226w
SPH 220	€	905,70 557w	999,30 697w	1093,90 836w	1200,80 976w	1285,90 1115w	1380,40 1254w	1472,90 1394w	1569,80 1533w	1665,60 1673w
SPLH 220	€	1167,50 802w	1289,80 1003w	1410,10 1204w	1540,60 1404w	1652,70 1605w	1772,70 1806w	1893,40 2006w	2012,30 2207w	2132,80 2407w
SPH 240	€	971,00 601w	1073,10 751w	1175,10 901w	1277,00 1051w	1378,80 1201w	1481,20 1351w	1583,00 1502w	1687,60 1652w	1790,90 1802w

Versions with SUIT measurements on request

Δt different from 50 K: consult technical data Brem

HOW TO ORDER

State: model (whether simple or with fins), height and width; fittings and color.

e.g.: SPH 180 - 35, AC \varnothing 1/2", BR 0007

MAGNETIC ACCESSORIES p. 277

STANDARD PRODUCTION

White sablé SB9016 paintwork, EOS brackets
Tolerance \pm 3mm - Air vent \varnothing 1/8"

MAXIMUM OPERATING PRESSURE 6 BAR

PRODUCTION ON REQUEST

Paintwork to Brem color list +15/25%
S-PLATT INOX, cover panels in satin stainless steel on request

STANDARD FITTING

EG \varnothing 1/2"
Fittings AC or BD with extra
Special fittings, page 278

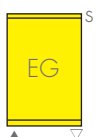

TAPPING CENTRES

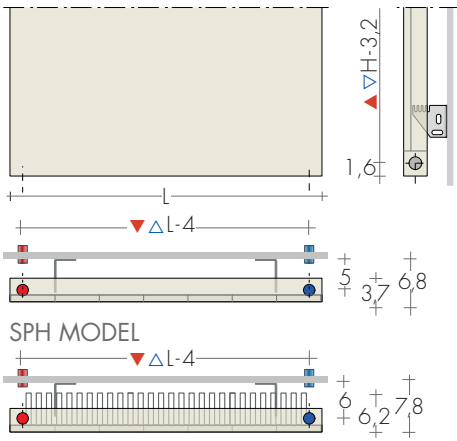

SPLH MODEL

Side fittings on request
Extra

Art. AS 91,20€

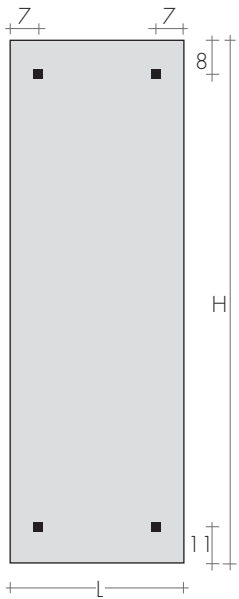

FIXINGS
Brackets included



EOS bracket



SPH 200-49

RECOMMENDED VALVES

CHROME VALVES KIT with:

- n°2 Valves with chrome tailpieces
- n°2 Fittings (multilayer ø16, copper ø12, 14)
- n°2 Chrome wall plates ø 48, hole ø16

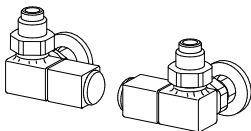

KIT SIDE control VALVES QUADRA
page 271 Art. KQL 191,20€
Extra for BREM color list 53,40€

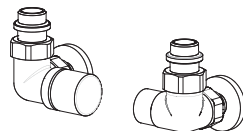

KIT SIDE control VALVES CYL with THERMOSTATIC
option, page 273 Art. KCL 162,50€
Extra for BREM color list 53,40€

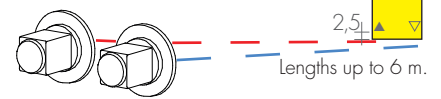

SPECIAL FINISHES page 267
Finishes Gold, Bronze, Brushed Nickel for 2 valves
Brushed Nickel FITTING KIT extra Art. RN 30,50€

REMOTE FITTINGS Art. REM 42,10€
Tapping centres: at the rear ▲▼ EG L-5 cm
DISTANT Valves page 274

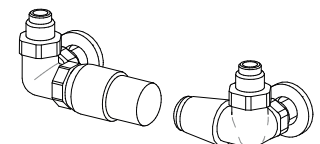

KIT SIDE control VALVES TON with Thermostatic
Head, page 269 Art. KTL 203,70€

SPV - PLATT

SP-PLATT is a perfectly flat, smooth radiating plate. It comes in the simple horizontal

version (SPV) or with radiating plates fitted at the back in varying heights (SPLV). S-Platt

plates are painted white sablé as standard. Ideal for artistic rendering, as requested

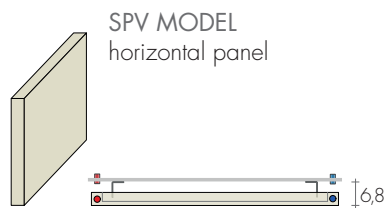

SPV

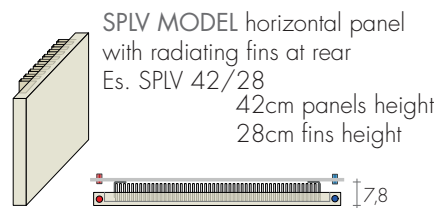

SPLV

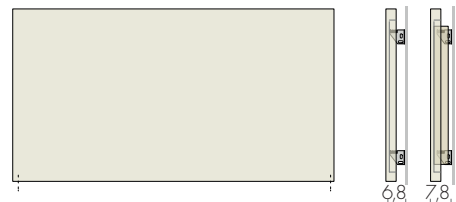

SPV ... SPLV ...

SPV SPLV

EN 442 Watt Δt 50K (Δt 40K = $W \times 0,755$) - (Δt 30K = $W \times 0,526$)

MOD.	L cm	50	60	70	80	90	100	110	120	140	160	180	200	220
H cm	▲▼ cm	46,8	56,8	66,8	76,8	86,8	96,8	106,8	116,8	136,8	156,8	176,8	196,8	216,8
SPV 35	€	705,00 178w	732,00 213w	756,70 249w	781,10 284w	804,80 320w	832,70 355w	858,30 391w	882,80 426w	929,80 497w	975,40 568w	1004,50 639w	1034,30 710w	1065,30 781w
SPLV 35/35	€	876,00 367w	909,60 440w	944,60 513w	982,20 586w	1016,10 660w	1053,90 733w	1089,40 806w	1123,50 880w	1191,00 1026w	1258,10 1173w	1298,10 1319w	1337,80 1466w	1378,40 1613w
SPV 42	€	748,30 217w	778,40 260w	802,00 304w	829,10 347w	857,80 391w	886,40 434w	910,90 477w	941,60 521w	995,50 608w	1058,50 694w	1088,30 781w	1118,50 868w	1151,70 955w
SPLV 42/28	€	917,30 380w	955,40 456w	992,30 532w	1028,60 608w	1068,70 684w	1106,10 760w	1144,10 836w	1183,40 912w	1257,90 1064w	1338,70 1216w	1380,80 1368w	1422,60 1520w	1464,80 1672w
SPLV 42/42	€	929,40 417w	973,40 500w	1011,70 584w	1050,20 667w	1092,70 751w	1129,90 834w	1171,20 917w	1213,20 1001w	1289,50 1168w	1376,50 1334w	1419,80 1501w	1462,70 1668w	1507,50 1835w
SPV 49	€	787,20 246w	818,30 295w	849,30 344w	880,90 394w	911,70 443w	942,90 492w	974,30 541w	1006,40 590w	1069,00 689w	1142,10 787w	1177,20 886w	1212,30 984w	1247,10 1083w
SPLV 49/28	€	955,70 412w	998,50 494w	1040,00 576w	1080,40 658w	1123,90 741w	1165,10 823w	1205,80 905w	1249,00 988w	1332,10 1152w	1424,60 1317w	1470,60 1481w	1516,50 1646w	1561,50 1811w
SPLV 49/49	€	987,10 466w	1035,70 559w	1079,30 652w	1123,70 745w	1171,70 838w	1214,40 931w	1261,30 1024w	1308,00 1117w	1396,10 1303w	1493,70 1490w	1541,90 1676w	1589,80 1862w	1639,00 2048w
SPV 56	€	834,60 276w	869,90 331w	903,30 386w	938,20 441w	974,70 496w	1010,50 551w	1045,60 606w	1081,20 661w	1149,90 771w	1226,20 882w	1264,30 992w	1302,20 1102w	1339,20 1212w
SPLV 56/28	€	1001,20 444w	1050,00 533w	1093,70 622w	1140,50 710w	1183,60 799w	1229,20 888w	1277,00 977w	1321,60 1066w	1411,00 1243w	1509,30 1421w	1556,70 1598w	1604,10 1776w	1651,10 1954w
SPLV 56/56	€	1044,30 511w	1098,00 613w	1147,00 715w	1197,30 818w	1250,80 920w	1298,90 1022w	1351,50 1124w	1402,80 1226w	1502,60 1431w	1610,90 1635w	1664,10 1840w	1717,20 2044w	1770,40 2249w
SPV 63	€	879,20 305w	921,10 366w	961,70 427w	1001,50 488w	1042,30 549w	1081,70 610w	1122,50 671w	1162,80 732w	1237,80 854w	1318,80 976w	1359,60 1098w	1400,20 1220w	1439,30 1342w
SPLV 63/35	€	1050,30 501w	1101,40 601w	1150,40 701w	1202,30 801w	1250,80 901w	1302,90 1001w	1352,40 1101w	1405,80 1201w	1500,00 1401w	1602,70 1602w	1652,70 1802w	1702,30 2002w	1751,70 2202w
SPLV 63/63	€	1091,40 557w	1149,50 668w	1202,50 779w	1258,80 890w	1313,60 1002w	1371,40 1113w	1428,10 1224w	1483,30 1336w	1590,20 1558w	1701,50 1781w	1758,00 2003w	1814,10 2226w	1869,70 2449w
SPV 70	€	958,70 326w	1001,60 391w	1046,90 456w	1088,50 521w	1135,00 586w	1175,80 651w	1220,90 716w	1266,40 781w	1346,40 911w	1436,80 1042w	1480,80 1172w	1524,70 1302w	1568,70 1432w
SPLV 70/35	€	1127,10 532w	1180,50 638w	1235,00 744w	1290,40 850w	1344,90 957w	1395,70 1063w	1450,20 1169w	1504,50 1276w	1606,50 1488w	1716,80 1701w	1771,80 1913w	1826,80 2126w	1880,50 2339w
SPLV 70/70	€	1167,20 598w	1226,10 718w	1285,00 837w	1343,90 957w	1403,90 1076w	1463,10 1196w	1523,20 1316w	1582,20 1435w	1694,30 1674w	1817,40 1914w	1876,90 2153w	1936,60 2392w	1995,10 2631w
SPV 77	€	1023,90 365w	1070,50 437w	1114,60 510w	1161,00 583w	1207,20 656w	1251,50 729w	1298,90 802w	1342,70 875w	1428,90 1021w	1525,80 1166w	1571,80 1312w	1618,40 1458w	1665,00 1604w
SPLV 77/35	€	1192,80 562w	1249,00 674w	1304,80 787w	1361,70 899w	1415,80 1012w	1474,70 1124w	1531,80 1236w	1587,40 1349w	1693,30 1574w	1810,70 1798w	1866,50 2023w	1922,40 2248w	1980,70 2473w
SPLV 77/70	€	1232,40 624w	1296,00 749w	1357,40 874w	1418,40 998w	1479,70 1123w	1542,10 1248w	1603,20 1373w	1664,40 1498w	1782,50 1747w	1909,00 1997w	1970,20 2246w	2032,00 2496w	2094,10 2746w
SPV 84	€	1093,30 394w	1143,30 472w	1192,10 551w	1241,70 630w	1289,30 708w	1338,10 787w	1387,70 866w	1437,90 944w	1532,50 1102w	1630,60 1259w	1681,50 1417w	1732,50 1574w	1781,40 1732w
SPLV 84/35	€	1262,10 590w	1321,20 708w	1381,00 826w	1440,00 944w	1500,20 1062w	1559,40 1180w	1617,30 1298w	1676,10 1416w	1792,10 1652w	1913,20 1888w	1973,80 2124w	2034,10 2360w	2094,10 2596w
SPLV 84/70	€	1304,50 652w	1369,20 782w	1433,80 912w	1497,60 1042w	1359,80 1173w	1628,00 1303w	1692,50 1433w	1756,90 1564w	1884,40 1824w	2014,90 2085w	2079,80 2345w	2144,80 2606w	2211,00 2867w
SPV91	€	1144,90 424w	1199,00 509w	1252,90 594w	1308,00 678w	1359,80 763w	1413,60 848w	1471,30 933w	1523,90 1018w	1626,60 1187w	1732,60 1357w	1785,40 1526w	1838,60 1696w	1890,60 1866w

Versions with SUIT measurements on request

Δt different from 50 K: consult technical data Brem

STANDARD PRODUCTION

White sablé SB9016 paintwork, EOS brackets
Tolerance \pm 3mm - Air vent \varnothing 1/8"
MAXIMUM OPERATING PRESSURE 6 BAR

PRODUCTION ON REQUEST

Paintwork to Brem color list +15/25%
S-PLATT INOX, cover panels in satin stainless steel on request

STANDARD FITTING

EG \varnothing 1/2"
Fittings AC or BD with extra
Special fittings, page 278



TAPPING CENTRES

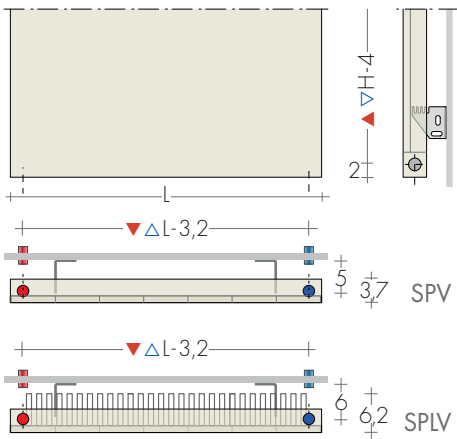

Side fittings on request
Extra

Art. AS 91,20€

FIXINGS

Brackets included

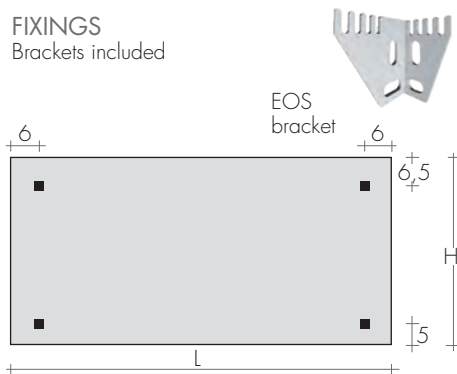

HOW TO ORDER

State: model (whether simple or with fins),
height and width; fittings and color.
es.: SPLV 49/49-180, EG ø1/2", BR0004
Plate height 49/ fins height 49/ width 180

RECOMMENDED VALVES

CHROME VALVES KIT with:

- n°2 Valves with chrome tailpieces
- n°2 Fittings (multilayer ø16, copper ø12, 14)
- n°2 Chrome wall plates ø 48, hole ø16

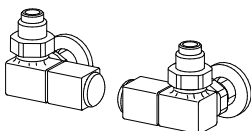

KIT SIDE control VALVES QUADRA
page 271 Art. KQL 191,20€
Extra for BREM color list 53,40€

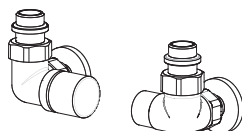

KIT SIDE control VALVES CYL with THERMOSTATIC
option, page 273 Art. KCL 162,50€
Extra for BREM color list 53,40€

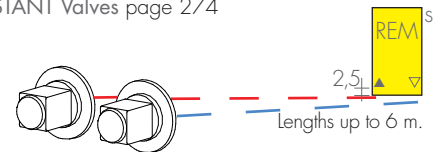

SPECIAL FINISHES page 267
Finishes Gold, Bronze, Brushed Nickel for 2 valves
Brushed Nickel FITTING KIT extra Art. RN 30,50€

REMOTE FITTINGS Art. REM 42,10€
Tapping centres: at the rear of radiator ▲▼ L - 3,2 cm
DISTANT Valves page 274



PLATT SPV 35 - 160

SUIT-H

SUIT-H is created with flattened tubes that merge imperceptibly with the manifolds

assembled in such way as to create a completely flat radiating surface cadenced by the

union of its various elements. Is available in single or double form and with fins at the rear.

MODEL SUIT-H..
with flattened vertical tubes

H = 60 to 220 cm
(every 20 cm)

L = 14 to 98 cm
(1 to 14 elements)

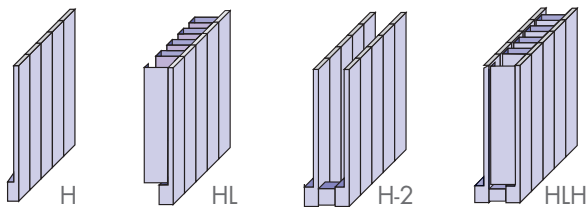

TAPPING CENTRES

EG vertical fittings as standard
Side fittings on request without extra

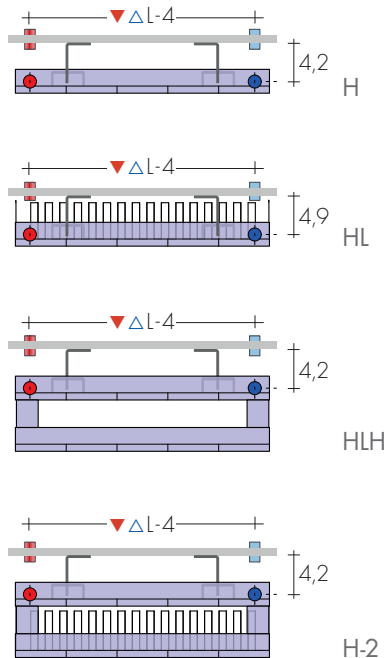
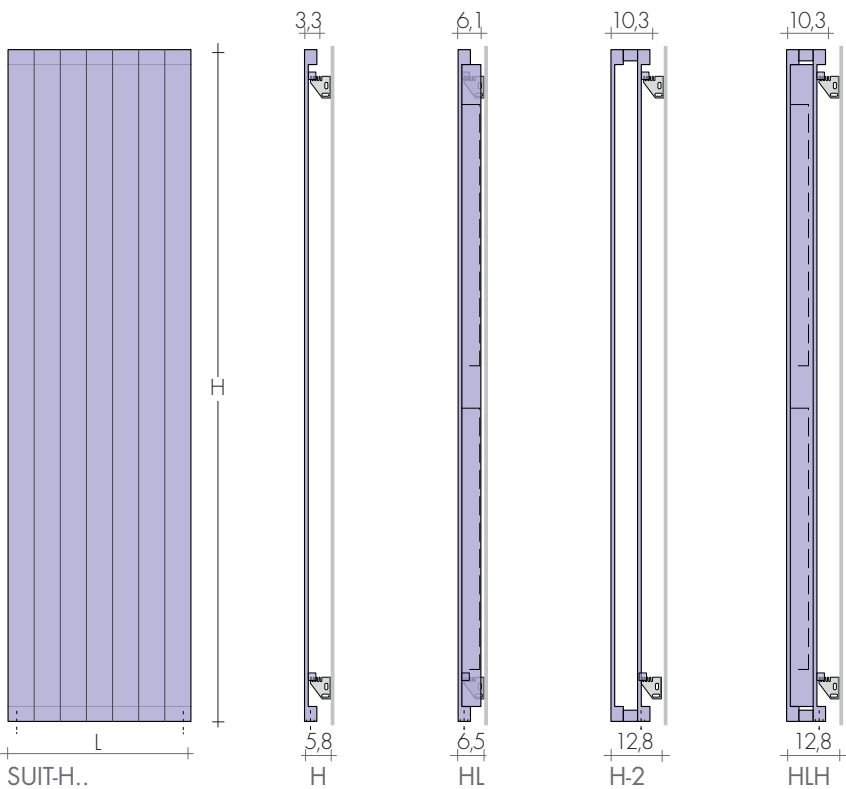
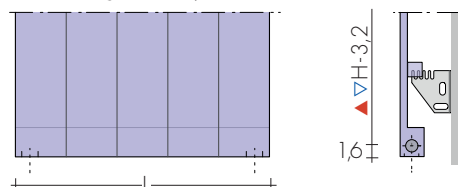

Standard lateral bands for plates with fins.

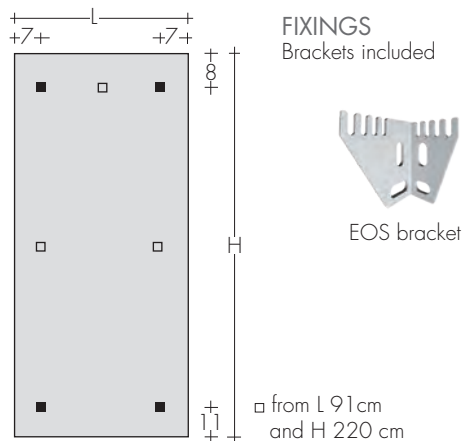

FIXINGS
Brackets included

EOS bracket

SUIT-H + fins
plate at rear
height tubes cm
width cm

HLH 180 - 49

HOW TO ORDER

State: model (L indicates fins) with height and length in cm; fitting and color if different from standard
eg.: HL 180 - 49, AC \varnothing 1/2", RAL 3005

HEIGHTS ON REQUEST

H, HL, H-2, HLH: 120, 140, 150 cm
H, H-2: 300 cm

- Heights every 10 cm: thermal output and price by interpolation; see price of increased size.

- Heights every 1 cm: thermal output by interpolation; price: increased size + 20%
lengths up to 1,4m: contact Brem technical office

STANDARD PRODUCTION

White sablé SB9016 paintwork, EOS brackets
Air vent \varnothing 1/2" - Tolerance \pm 3 mm
Maximum operating pressure 6 bar.

PRODUCTION ON REQUEST

Paintwork to Brem color list up to 3 m
+15/25%
(ask for feasibility in case of higher values)

STANDARD FITTINGS EG \varnothing 1/2"

\blacktriangle ∇ L-4 cm
AC or BD fittings on request
Special fittings, page 278



MOD. H cm	L cm (n° el.) ▲▼	EN 442 Watt Δt 50K (Δt 40K = Wx0,755) - (Δt 30K = Wx0,526)													
		14	21	28	35	42	49	56	63	70	77	84	91	98	
H60	€	182,40 85w	220,80 127w	260,30 170w	299,90 212w	337,20 255w	377,80 297w	417,30 339w	456,10 382w	495,20 424w	533,80 467w	572,90 509w	611,60 551w	651,10 594w	
HL60	€	311,00 138w	354,30 207w	396,00 276w	438,00 345w	478,50 415w	521,40 484w	564,60 553w	606,10 622w	648,10 691w	690,00 760w	732,30 829w	774,30 898w	816,30 967w	
H60-2	€	516,30 141w	593,90 211w	672,00 282w	750,10 352w	828,40 423w	906,30 493w	981,80 564w	1062,00 634w	1139,90 705w	1217,40 775w	1295,50 846w	1373,70 916w	1451,40 987w	
HLH60	€	674,50 197w	746,50 296w	819,20 394w	891,70 493w	964,90 591w	1038,50 690w	1109,70 788w	1183,50 887w	1256,10 986w	1328,90 1084w	1401,50 1183w	1474,40 1281w	1529,10 1380w	
H80	€	213,00 111w	257,90 166w	301,10 221w	348,80 277w	393,30 332w	435,30 388w	480,80 443w	526,30 498w	569,00 554w	614,30 609w	659,30 665w	703,60 720w	748,40 775w	
HL80	€	313,40 177w	358,50 265w	404,00 354w	457,20 442w	508,80 531w	563,50 619w	613,10 708w	665,20 796w	717,40 885w	770,70 973w	821,20 1062w	873,00 1150w	925,00 1239w	
H80-2	€	551,00 179w	638,10 269w	727,40 359w	816,80 448w	906,30 538w	993,60 628w	1082,80 717w	1172,10 807w	1261,60 897w	1348,10 986w	1438,40 1076w	1527,00 1166w	1616,20 1255w	
HLH80	€	677,00 246w	750,40 368w	828,40 491w	919,60 614w	1011,40 737w	1103,20 859w	1194,80 982w	1286,40 1105w	1378,20 1228w	1469,60 1350w	1561,10 1473w	1652,60 1596w	1744,30 1719w	
H100	€	229,60 137w	279,30 205w	328,30 273w	377,80 341w	428,10 410w	478,50 478w	526,30 546w	575,80 614w	626,60 683w	674,50 751w	726,40 819w	774,70 887w	826,10 956w	
HL100	€	334,70 214w	393,30 320w	449,20 427w	507,20 534w	564,60 641w	622,40 747w	680,00 854w	736,30 961w	794,30 1068w	851,60 1174w	910,80 1281w	969,70 1388w	1025,90 1495w	
H100-2	€	587,10 217w	685,80 325w	784,00 434w	882,10 542w	981,80 651w	1080,60 759w	1179,00 867w	1277,50 976w	1378,20 1084w	1476,50 1193w	1574,40 1301w	1674,30 1410w	1772,70 1518w	
HLH100	€	685,80 299w	786,10 448w	887,00 598w	987,80 747w	1087,10 896w	1187,80 1046w	1288,60 1195w	1389,50 1344w	1490,00 1494w	1589,40 1643w	1690,60 1793w	1791,20 1942w	1891,60 2091w	
H160	€	287,30 210w	351,80 315w	417,30 420w	478,50 525w	543,40 630w	608,70 735w	672,00 840w	734,50 945w	799,80 1050w	863,10 1155w	927,60 1260w	993,60 1365w	1054,50 1470w	
HL160	€	446,90 314w	533,00 471w	620,00 629w	704,90 786w	789,80 943w	875,60 1100w	962,60 1257w	1047,60 1414w	1134,90 1572w	1219,60 1729w	1305,50 1886w	1390,10 2043w	1475,60 2200w	
H160-2	€	696,60 326w	819,20 488w	944,80 651w	1070,40 814w	1194,80 977w	1318,10 1139w	1442,40 1302w	1568,00 1465w	1692,40 1628w	1815,70 1790w	1940,40 1953w	2066,10 2116w	2190,20 2279w	
HLH160	€	837,30 431w	983,20 646w	1129,90 862w	1275,30 1077w	1422,00 1293w	1568,00 1508w	1715,40 1724w	1860,00 1939w	2007,90 2155w	2155,10 2370w	2299,90 2586w	2448,20 2801w	2592,90 3017w	
H180	€	325,10 234w	399,40 350w	473,50 467w	546,10 584w	617,80 701w	693,30 817w	766,90 934w	838,80 1051w	913,60 1168w	986,50 1284w	1061,10 1401w	1134,90 1518w	1206,70 1635w	
HL180	€	505,00 344w	602,20 516w	695,40 689w	790,20 861w	886,40 1033w	981,80 1205w	1077,60 1377w	1172,20 1549w	1268,30 1721w	1364,00 1893w	1457,90 2065w	1553,80 2237w	1648,30 2410w	
H180-2	€	757,30 360w	898,20 540w	1037,80 720w	1178,40 900w	1317,80 1079w	1458,60 1259w	1598,40 1439w	1739,50 1619w	1879,00 1799w	2019,60 1979w	2158,10 2159w	2300,00 2339w	2438,70 2518w	
HLH180	€	946,30 474w	1111,60 711w	1279,40 949w	1444,50 1186w	1610,30 1423w	1742,80 1660w	1940,70 1897w	2105,70 2134w	2273,50 2372w	2439,60 2609w	2604,40 2846w	2769,90 3083w	2934,70 3320w	
H200	€	341,20 257w	418,90 385w	495,40 513w	571,80 642w	650,60 770w	723,60 898w	800,90 1026w	877,50 1155w	954,00 1283w	1033,00 1411w	1109,10 1540w	1187,20 1668w	1263,20 1796w	
HL200	€	531,70 371w	633,70 557w	736,80 742w	836,00 928w	939,50 1113w	1041,30 1299w	1144,90 1484w	1246,10 1670w	1348,10 1855w	1450,40 2041w	1553,80 2226w	1657,00 2412w	1758,80 2597w	
H200-2	€	819,20 393w	974,60 590w	1128,60 787w	1284,00 984w	1439,20 1180w	1593,90 1377w	1749,00 1574w	1904,30 1770w	2058,40 1967w	2213,70 2164w	2369,10 2361w	2523,40 2557w	2678,60 2754w	
HLH200	€	984,50 515w	1161,90 772w	1338,80 1030w	1517,40 1287w	1694,80 1544w	1871,50 1802w	2049,20 2059w	2228,10 2317w	2405,40 2574w	2583,10 2832w	2759,90 3089w	2937,10 3346w	3114,70 3604w	
H220	€	356,80 279w	441,70 418w	524,50 557w	605,50 697w	688,00 836w	771,70 976w	855,70 1115w	938,20 1254w	1018,50 1394w	1103,60 1533w	1187,20 1673w	1268,30 1812w	1349,80 1951w	
HL220	€	557,20 401w	665,20 602w	771,70 802w	881,70 1003w	989,20 1204w	1096,10 1404w	1206,70 1605w	1314,40 1806w	1423,00 2006w	1529,20 2207w	1637,40 2407w	1746,60 2608w	1853,20 2809w	
H220-2	€	860,70 426w	1025,70 639w	1192,90 851w	1360,80 1064w	1525,80 1277w	1694,80 1490w	1862,10 1703w	2026,80 1916w	2194,40 2129w	2361,60 2342w	2528,20 2555w	2695,70 2768w	2863,20 2980w	
HLH220	€	1068,10 555w	1262,40 832w	1456,70 1110w	1650,70 1387w	1847,30 1665w	2041,40 1942w	2235,70 2220w	2430,00 2497w	2624,00 2775w	2816,80 3052w	3011,20 3330w	3205,60 3607w	3399,30 3885w	

Δt different from 50 K: consult Technical data Brem

RECOMMENDED VALVES

CHROME VALVES KIT with:

- n°2 Valves with chrome tailpieces
- n°2 Fittings (multilayer ϕ 16, copper ϕ 12, 14)
- n°2 Chrome wall plates ϕ 48, hole ϕ 16

SPECIAL FINISHES

Finishes Gold, Bronze, Brushed Nickel for 2 valves
Brushed Nickel FITTING KIT extra Art. RN 30,50€

page 267

REMOTE FITTINGS

Art. REM 42,10€
Tapping centres: at the rear ▲▼ EG L-5 cm

DISTANT Valves page 274

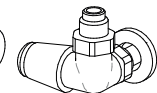
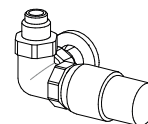
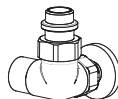
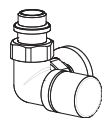
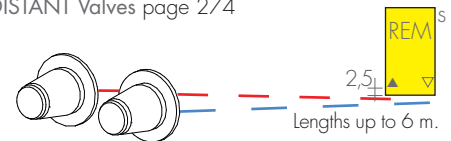

KIT SIDE control VALVES TON
page 269

Art. KVL 150,50€

SIDE CONTROL CYL VALVES KIT with THERMO-
STATIC option, page 273 Art. KCL 162,50€
Extra for BREM color list 53,40€

KIT SIDE control VALVES TON with Thermostatic
head, page 269 Art. KTL 203,70€

SUIT-V

We find the characteristics of the flat tubes assembled also in SUIT-V, where

the manifold and flat tubes are perfectly matched together. Here, however, the

heating element is positioned horizontally. In single or double version, with fins at the rear.

MODEL SUIT-V.. with flattened horizontal tubes

H = 28 to 140 cm (every 7 cm)

L = 50 to 240 cm (every 10 cm)

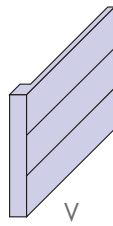

V

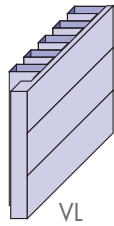

VL

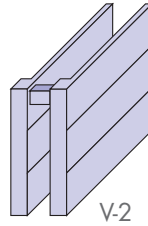

V-2

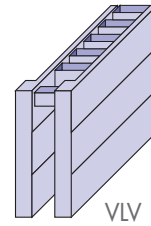

VLV

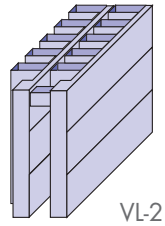

VL-2

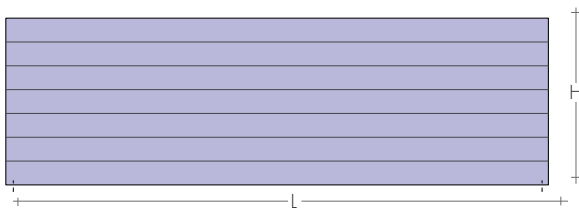

H

L



V

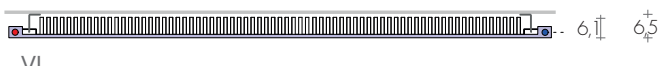

VL



V-2



VLV



VL-2

TAPPING CENTRES

EG vertical fittings as standard
Side fittings on request without extra

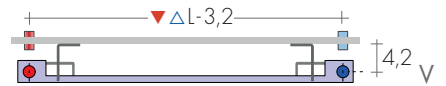
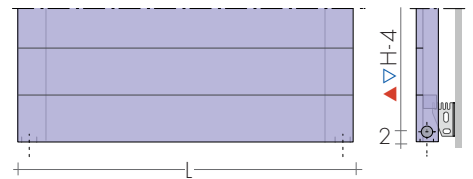

V

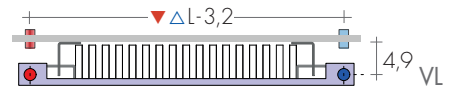

VL

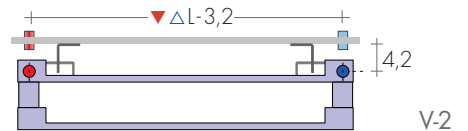

V-2

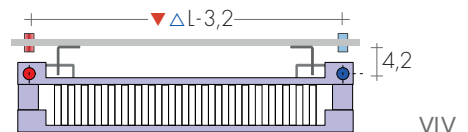

VLV

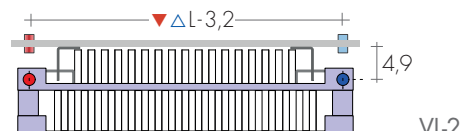

VL-2

HOW TO ORDER

State: model (L indicates fins) with height, height of fins and length in cm; fitting and color if different from standard
eg.: VL 42/28-180, AC \varnothing 1/2", BR 0002

STANDARD PRODUCTION

White sablé SB9016 paintwork, EOS brackets
Air vent \varnothing 1/2" - Tolerance \pm 3 mm
Maximum operating pressure 6 bar.

PRODUCTION ON REQUEST

Paintwork to Brem color list up to 3 m
+15/25%
(ask for feasibility in case of higher values)

FIXINGS
EOS brackets included



□ from L 220 cm

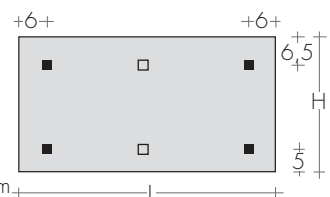

STANDARD FITTINGS

EG \varnothing 1/2" ∇ L-3,2 cm
AC or BD Fittings on request
Special fittings page 278

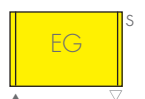



SUIT H 180 - 49

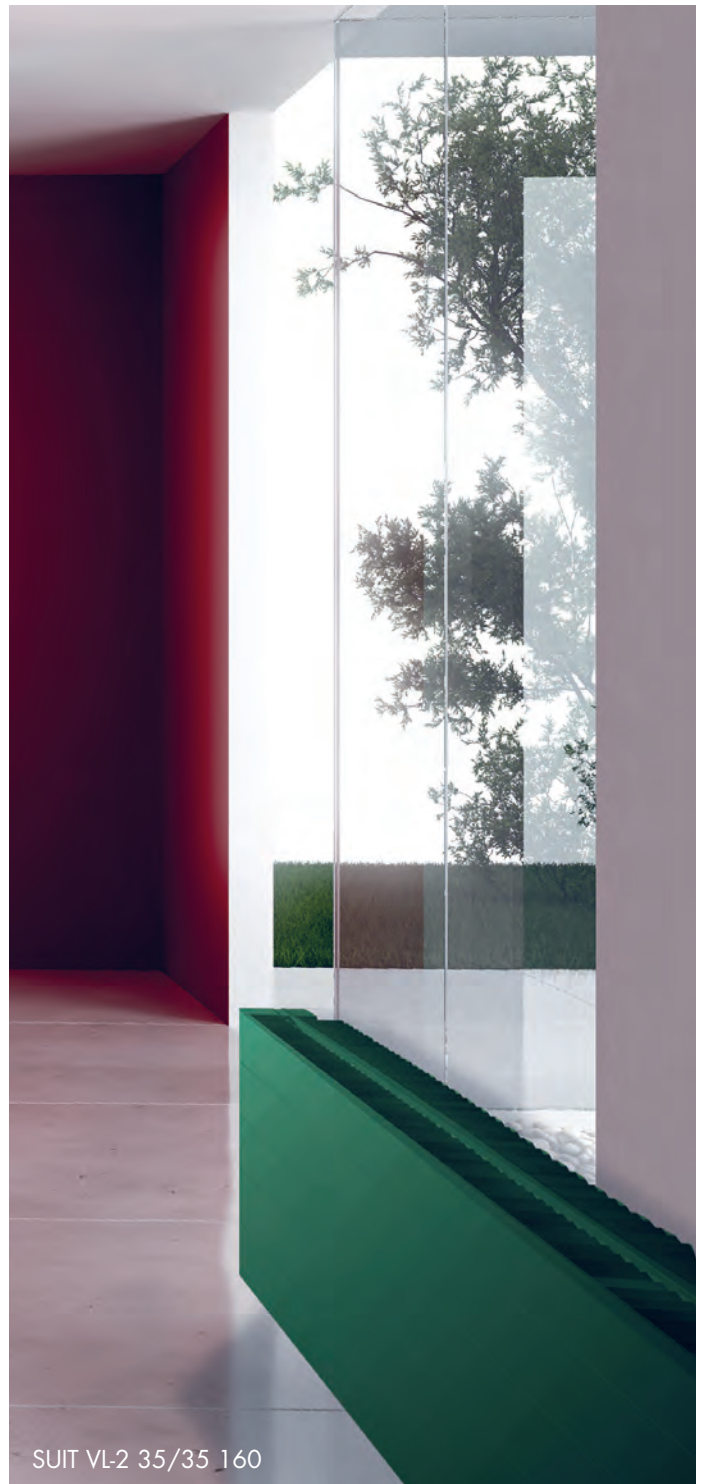

SUIT VL-2 35/35 160

RECOMMENDED VALVES

CHROME VALVES KIT with:

- n°2 Valves with chrome tailpieces
- n°2 Fittings (multilayer ø16, copper ø12, 14)
- n°2 Chrome wall plates ø 48, hole ø16



SIDE CONTROL TON VALVES
page 269

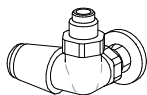

Art. KVL 150,50€

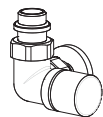

SIDE CONTROL CYL VALVES KIT with THERMO-
STATIC option, page 273 Art. KCL 162,50€
Extra for BREM color list 53,40€

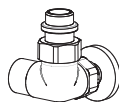

SPECIAL FINISHES page 267
Finishes Gold, Bronze, Brushed Nickel for 2 valves
Brushed Nickel FITTING KIT extra Art. RN 30,50€

REMOTE FITTINGS Art. REM 42,10€
Tapping centres: at the rear ▲▼ EG L-5 cm
DISTANT Valves page 274

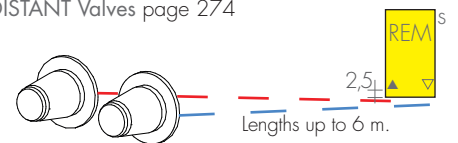

KIT SIDE control VALVES TON with Thermostatic
head, page 269 Art. KTL 203,70€

SUIT-V

EN 442 Watt Δt 50K (Δt 40K = $W \times 0,755$) - (Δt 30K = $W \times 0,526$)

MOD.	L cm Hcm	EN 442 Watt Δt 50K (Δt 40K = $W \times 0,755$) - (Δt 30K = $W \times 0,526$)													
		50 ▲▽cm46,8	60 56,8	70 66,8	80 76,8	90 86,8	100 96,8	110 106,8	120 116,8	140 136,8	160 156,8	180 176,8	200 196,8	220 216,8	240 236,8
V28	€	279,30 144w	294,20 173w	309,00 202w	323,70 230w	337,20 259w	354,30 288w	370,20 317w	382,40 346w	411,70 403w	441,50 461w	468,30 518w	500,20 576w	528,40 634w	559,10 691w
VL28/28	€	406,30 314w	431,00 377w	458,50 440w	481,80 502w	507,20 565w	531,70 628w	556,50 691w	580,30 754w	632,60 879w	681,00 1005w	729,90 1130w	781,60 1256w	830,50 1382w	880,20 1507w
V28-2	€	698,10 256w	728,70 307w	758,00 358w	787,70 409w	815,80 460w	845,30 511w	874,50 562w	901,70 613w	962,60 715w	1019,30 818w	1076,20 920w	1137,20 1022w	1193,00 1124w	1252,30 1226w
V35	€	310,40 178w	328,30 213w	345,40 249w	361,30 284w	377,80 320w	397,30 355w	414,00 391w	431,00 426w	464,90 497w	497,80 568w	533,00 639w	566,70 710w	600,40 781w	635,80 852w
VL35/35	€	438,00 367w	464,90 440w	492,10 513w	519,60 586w	547,80 660w	573,30 733w	600,40 806w	630,30 880w	684,50 1026w	736,30 1173w	792,00 1319w	846,90 1466w	901,70 1613w	955,90 1759w
V35-2	€	760,30 308w	797,70 370w	830,50 431w	863,10 493w	898,10 554w	932,40 616w	967,30 678w	1000,20 739w	1069,20 862w	1137,20 986w	1205,80 1109w	1273,90 1232w	1343,00 1355w	1408,80 1478w
VLV35/35	€	887,00 501w	931,10 601w	976,40 701w	1020,70 802w	1065,50 902w	1107,50 1002w	1152,80 1102w	1196,70 1202w	1286,40 1403w	1375,70 1603w	1465,10 1804w	1554,60 2004w	1641,60 2204w	1730,80 2405w
VL35/35-2	€	1013,60 681w	1070,40 817w	1123,40 953w	1179,00 1090w	1233,00 1226w	1286,40 1362w	1341,60 1498w	1396,10 1634w	1504,80 1907w	1614,40 2179w	1724,40 2452w	1831,80 2724w	1940,40 2996w	2050,20 3269w
V42	€	345,40 217w	363,10 260w	382,40 304w	401,70 347w	420,90 391w	441,50 434w	457,20 477w	476,30 521w	516,30 608w	551,90 694w	590,70 781w	630,30 868w	665,20 955w	704,90 1042w
VL42/28	€	470,60 380w	500,20 456w	530,50 532w	561,50 608w	588,30 684w	616,70 760w	646,20 836w	674,50 912w	734,50 1064w	792,00 1216w	851,00 1368w	908,50 1520w	967,30 1672w	1024,00 1824w
VL42/42	€	476,30 417w	507,20 500w	539,60 584w	569,00 667w	600,40 751w	634,80 834w	665,20 917w	695,90 1001w	758,00 1168w	821,50 1334w	882,10 1501w	945,80 1668w	1006,90 1835w	1069,20 2002w
V42-2	€	830,50 362w	868,80 434w	906,30 506w	943,00 578w	980,90 651w	1019,30 723w	1057,80 795w	1095,20 868w	1169,80 1012w	1245,70 1157w	1321,70 1302w	1398,40 1446w	1472,90 1591w	1547,40 1735w
VLV42/28	€	955,90 534w	1004,50 641w	1054,50 748w	1100,70 854w	1150,50 961w	1196,70 1068w	1245,70 1175w	1295,30 1282w	1391,50 1495w	1487,70 1709w	1583,90 1922w	1678,80 2136w	1777,70 2350w	1873,80 2563w
VLV42/42	€	960,50 570w	1011,40 683w	1063,80 797w	1112,00 911w	1160,50 1025w	1212,80 1139w	1263,50 1253w	1313,80 1367w	1414,30 1595w	1514,00 1822w	1614,40 2050w	1715,40 2278w	1815,70 2506w	1916,40 2734w
VL42/28-2	€	1085,20 693w	1143,50 832w	1201,50 970w	1259,20 1109w	1318,10 1247w	1375,70 1386w	1437,00 1525w	1494,20 1663w	1609,60 1940w	1728,90 2218w	1845,30 2495w	1960,40 2772w	2079,40 3049w	2194,50 3326w
VL42/42-2	€	1093,90 768w	1157,10 921w	1219,60 1075w	1281,80 1228w	1344,00 1382w	1407,30 1535w	1469,60 1689w	1531,90 1842w	1657,30 2149w	1781,80 2456w	1907,20 2763w	2032,10 3070w	2157,50 3377w	2281,90 3684w
V49	€	373,20 246w	396,00 295w	417,30 344w	438,00 394w	459,50 443w	480,80 492w	502,30 541w	523,80 590w	566,70 689w	611,10 787w	653,90 886w	698,10 984w	741,30 1083w	784,00 1181w
VL49/28	€	500,20 412w	530,50 494w	563,50 576w	595,20 658w	626,60 741w	659,90 823w	691,50 905w	721,60 988w	787,70 1152w	851,60 1317w	915,30 1481w	978,50 1646w	1043,40 1811w	1106,40 1975w
VL49/49	€	504,90 466w	539,60 559w	571,10 652w	608,70 745w	641,30 838w	674,50 931w	708,30 1024w	741,30 1117w	811,10 1303w	878,00 1490w	946,80 1676w	1014,90 1862w	1082,80 2048w	1150,50 2234w
V49-2	€	884,70 415w	927,60 498w	972,90 581w	1017,10 664w	1061,00 747w	1103,20 830w	1146,00 913w	1189,00 996w	1278,50 1162w	1363,20 1328w	1449,20 1494w	1538,80 1660w	1623,70 1826w	1711,80 1992w
VLV49/28	€	1011,40 585w	1065,50 702w	1118,90 819w	1172,10 936w	1226,40 1053w	1279,60 1170w	1331,80 1287w	1384,70 1404w	1492,50 1638w	1598,60 1872w	1705,90 2106w	1813,70 2340w	1918,80 2574w	2025,20 2808w
VLV49/49	€	1016,10 636w	1072,60 763w	1128,00 890w	1181,20 1017w	1237,80 1144w	1293,20 1271w	1348,10 1398w	1405,40 1525w	1514,00 1779w	1625,70 2034w	1735,70 2288w	1846,40 2542w	1958,40 2796w	2068,10 3050w
VL49/28-2	€	1139,00 746w	1201,50 895w	1265,80 1044w	1331,80 1194w	1394,00 1343w	1456,10 1492w	1520,30 1641w	1585,90 1790w	1710,50 2089w	1840,50 2387w	1965,40 2686w	2095,20 2984w	2220,00 3283w	2349,50 3581w
VL49/49-2	€	1148,30 849w	1215,20 1019w	1284,10 1189w	1351,10 1358w	1417,60 1528w	1487,70 1698w	1554,60 1868w	1621,20 2038w	1758,00 2377w	1891,60 2717w	2027,40 3056w	2162,20 3396w	2297,60 3736w	2434,50 4075w
V56	€	409,80 276w	433,30 331w	457,20 386w	480,80 441w	504,90 496w	528,40 551w	549,80 606w	573,30 661w	622,40 771w	669,80 882w	717,40 992w	764,50 1102w	813,30 1212w	860,90 1322w
VL56/28	€	537,50 444w	569,00 533w	603,50 622w	635,80 710w	669,80 799w	706,90 888w	738,80 977w	773,90 1066w	839,60 1243w	908,50 1421w	976,40 1598w	1045,70 1776w	1113,40 1954w	1180,30 2131w
VL56/56	€	554,60 511w	595,20 613w	634,80 715w	674,50 818w	713,00 920w	754,50 1022w	792,00 1124w	830,50 1226w	908,50 1431w	988,80 1635w	1067,10 1840w	1146,00 2044w	1225,30 2249w	1304,70 2453w
V56-2	€	956,90 469w	1004,50 563w	1051,90 657w	1100,10 750w	1148,30 844w	1195,80 938w	1241,20 1032w	1288,60 1126w	1384,70 1313w	1481,10 1501w	1576,10 1688w	1672,40 1876w	1764,90 2064w	1860,90 2251w
VLV56/28	€	1082,80 637w	1141,50 764w	1199,20 891w	1256,80 1018w	1315,40 1146w	1373,70 1273w	1429,00 1400w	1487,70 1528w	1603,10 1782w	1719,50 2037w	1836,20 2291w	1951,70 2546w	2066,10 2800w	2182,40 3055w
VLV56/56	€	1100,70 697w	1165,00 836w	1228,20 975w	1290,90 1115w	1353,30 1254w	1417,60 1394w	1481,10 1533w	1543,10 1672w	1670,60 1951w	1795,60 2230w	1922,40 2509w	2047,60 2788w	2175,80 3067w	2299,90 3345w
VL56/28-2	€	1210,60 800w	1277,50 959w	1346,70 1119w	1416,20 1279w	1483,40 1439w	1550,10 1599w	1619,00 1759w	1688,10 1919w	1822,50 2239w	1960,40 2558w	2095,20 2878w	2233,10 3198w	2366,60 3518w	2506,30 3838w
VL56/56-2	€	1245,70 924w	1327,00 1109w	1405,40 1294w	1483,40 1478w	1561,10 1663w	1639,50 1848w	1719,50 2033w	1797,50 2218w	1953,80 2587w	2112,10 2957w	2269,60 3326w	2425,40 3696w	2584,00 4066w	2610,90 4435w
V63	€	441,50 305w	467,40 366w	492,10 427w	519,60 488w	545,20 549w	573,30 610w	600,40 671w	626,60 732w	680,00 854w	732,00 976w	787,70 1098w	839,60 1220w	893,80 1342w	946,80 1464w
VL63/35	€	566,70 501w	603,50 601w	641,30 701w	677,90 801w	714,80 901w	752,20 1001w	787,70 1101w	826,10 1201w	899,50 1401w	972,90 1602w	1047,60 1802w	1121,30 2002w	1193,00 2202w	1267,10 2402w
VL63/63	€	587,10 557w	630,30 668w	672,00 779w	713,00 890w	756,20 1002w	799,80 1113w	839,60 1224w	882,10 1336w	967,30 1558w	1050,00 1781w	1137,20 2003w	1219,60 2226w	1304,70 2449w	1390,10 2671w
V63-2	€	1019,30 522w	1073,50 626w	1126,80 731w	1180,30 835w	1234,60 940w	1286,40 1044w	1339,70 1148w	1394,70 1253w	1498,70 1462w	1608,80 1670w	1715,40 1879w	1823,70 2088w	1927,60 2297w	2036,40 2506w
VLV63/35	€	1148,30 710w	1212,80 851w	1275,30 993w	1339,70 1135w	1403,00 1277w	1466,20 1419w	1529,80 1561w	1594,10 1703w	1722,10 1987w	1848,80 2270w	1976,40 2554w	2103,20 2838w	2230,70 3122w	2357,50 3406w
VLV63/63	€	1165,00 757w	1234,60 908w	1304,70 1059w	1373,70 1210w	1442,40 1362w	1511,30 1513w	1579,50 1664w	1648,40 1816w	1786,60 2118w	1925,70 2421w	2061,70 2723w	2199,10 3026w	2338,30 3329w	2474,30 3631w
VL63/35-2	€	1272,90 894w	1346,70 1073w	1419,80 1252w	1494,20 1430w	1568,00 1609w	1643,70 1788w	1717,50 1967w	1791,20 2146w	1938,90 2503w	2086,20 2861w	2233,10 3218w	2380,10 3576w	2531,00 3934w	2678,10 4291w
VL63/63-2	€	1313,80 995w	1396,10 1193w	1481,10 1392w	1565,80 1591w	1650,80 1790w	1733,20 1989w	1818,40 2188w	1902,70 2387w	2072,70 2785w	2240,10 3182w	2409,70 3580w	2577,50 3978w	2746,90 4376w	2916,60 4774w

MOD.	L cm	EN 442 Watt Δt 50K (Δt 40K = Wx0,755) - (Δt 30K = Wx0,526)													
		50	60	70	80	90	100	110	120	140	160	180	200	220	240
	▲▽ cm 46,8	56,8	66,8	76,8	86,8	96,8	106,8	116,8	136,8	156,8	176,8	196,8	216,8	236,8	
V70	€	488,90 326w	519,60 391w	547,80 456w	579,20 521w	608,70 586w	638,10 651w	669,80 716w	698,10 781w	758,00 911w	821,50 1042w	880,20 1172w	941,20 1302w	1000,20 1432w	1061,00 1562w
VL70/35	€	614,30 532w	656,40 638w	693,60 744w	734,50 850w	776,20 957w	815,80 1063w	856,60 1169w	898,10 1276w	976,40 1488w	1057,80 1701w	1138,40 1913w	1219,60 2126w	1300,10 2339w	1380,40 2551w
VL70/70	€	634,80 598w	680,00 718w	726,40 837w	770,70 957w	815,80 1076w	860,90 1196w	906,30 1316w	951,40 1435w	1043,40 1674w	1134,90 1914w	1225,30 2153w	1319,10 2392w	1408,80 2631w	1498,70 2870w
V70-2	€	1114,20 574w	1174,20 689w	1236,50 804w	1297,70 918w	1356,70 1033w	1417,60 1148w	1475,60 1263w	1536,30 1378w	1658,80 1607w	1778,70 1837w	1897,30 2066w	2019,50 2296w	2139,30 2526w	2259,70 2755w
VLV70/35	€	1243,60 759w	1313,80 911w	1384,70 1063w	1453,60 1214w	1525,10 1366w	1596,60 1518w	1666,10 1670w	1737,90 1822w	1878,10 2125w	2019,50 2429w	2159,90 2732w	2302,50 3036w	2443,80 3340w	2584,10 3643w
VLV70/70	€	1261,60 812w	1337,60 974w	1413,60 1136w	1490,00 1298w	1565,80 1461w	1641,60 1623w	1715,40 1785w	1791,20 1948w	1942,60 2272w	2095,20 2597w	2246,80 2921w	2399,50 3246w	2549,90 3571w	2702,90 3895w
VL70/35-2	€	1371,40 942w	1451,40 1130w	1531,90 1318w	1612,40 1506w	1695,70 1695w	1772,70 1883w	1855,50 2071w	1935,80 2260w	2096,40 2636w	2260,50 3013w	2421,10 3389w	2581,90 3766w	2744,60 4143w	2905,20 4519w
VL70/70-2	€	1407,30 1056w	1498,70 1267w	1589,40 1478w	1681,30 1690w	1772,70 1901w	1862,40 2112w	1953,80 2323w	2045,70 2534w	2228,80 2957w	2412,10 3379w	2595,30 3802w	2778,40 4224w	2958,00 4646w	3141,90 5069w
V77	€	528,40 365w	563,50 437w	592,70 510w	626,60 583w	658,30 656w	691,50 729w	721,60 802w	754,50 875w	818,00 1021w	882,10 1166w	946,80 1312w	1012,70 1458w	1076,20 1604w	1140,30 1750w
VL77/35	€	656,40 562w	698,10 674w	741,30 787w	784,00 899w	826,10 1012w	868,80 1124w	910,80 1236w	954,10 1349w	1039,70 1574w	1124,80 1798w	1209,40 2023w	1295,30 2248w	1378,20 2473w	1465,10 2698w
VL77/70	€	674,50 624w	721,60 749w	770,70 874w	818,00 998w	865,50 1123w	915,30 1248w	962,60 1373w	1010,40 1498w	1106,40 1747w	1201,50 1997w	1297,70 2246w	1392,80 2496w	1486,60 2746w	1581,60 2995w
V77-2	€	1197,80 626w	1260,10 751w	1326,30 876w	1390,10 1002w	1453,60 1127w	1519,40 1252w	1583,90 1377w	1648,40 1502w	1778,70 1753w	1904,00 2003w	2034,40 2254w	2163,20 2504w	2291,00 2755w	2421,10 3005w
VLV77/35	€	1326,30 807w	1400,80 968w	1473,80 1130w	1550,10 1291w	1623,70 1453w	1699,40 1614w	1772,70 1775w	1847,60 1937w	1997,10 2260w	2145,90 2582w	2295,60 2905w	2444,70 3228w	2592,90 3551w	2742,10 3874w
VLV77/70	€	1344,00 865w	1424,30 1038w	1503,30 1211w	1583,90 1384w	1664,40 1557w	1744,40 1730w	1822,50 1903w	1902,70 2076w	2063,50 2422w	2221,70 2768w	2382,70 3114w	2540,60 3460w	2701,60 3806w	2860,90 4152w
VL77/35-2	€	1451,40 989w	1536,30 1187w	1621,20 1385w	1705,90 1582w	1791,20 1780w	1875,60 1978w	1962,80 2176w	2045,70 2374w	2215,00 2769w	2384,80 3165w	2554,70 3560w	2724,40 3956w	2896,20 4352w	3063,50 4747w
VL77/70-2	€	1490,00 1104w	1585,90 1325w	1678,80 1546w	1775,10 1766w	1870,80 1987w	1965,40 2208w	2061,40 2429w	2157,50 2650w	2347,70 3091w	2538,00 3533w	2728,90 3974w	2921,10 4416w	3111,40 4858w	3301,30 5299w
V84	€	569,00 394w	606,10 472w	641,30 551w	674,50 630w	710,40 708w	746,50 787w	781,60 866w	818,00 944w	887,00 1102w	959,40 1259w	1028,70 1417w	1100,10 1574w	1172,10 1732w	1241,20 1889w
VL84/35	€	695,90 590w	741,30 708w	787,70 826w	832,70 944w	878,00 1062w	922,90 1180w	969,70 1298w	1014,90 1416w	1106,40 1652w	1195,80 1888w	1286,40 2124w	1380,40 2360w	1471,80 2596w	1562,40 2832w
VL84/70	€	714,80 652w	764,50 782w	818,00 912w	868,80 1042w	919,60 1173w	970,70 1303w	1021,80 1433w	1071,50 1564w	1174,20 1824w	1276,00 2085w	1378,20 2345w	1481,10 2606w	1581,60 2867w	1684,70 3127w
V84-2	€	1278,50 678w	1349,60 813w	1419,80 949w	1491,20 1084w	1560,30 1220w	1632,70 1355w	1703,90 1491w	1772,70 1626w	1914,20 1897w	2057,70 2168w	2199,10 2439w	2338,30 2710w	2479,70 2981w	2621,10 3252w
VLV84/35	€	1407,30 853w	1487,70 1024w	1570,20 1194w	1650,80 1365w	1730,80 1535w	1813,70 1706w	1894,10 1877w	1974,10 2047w	2137,40 2388w	2297,60 2730w	2460,80 3071w	2623,50 3412w	2784,30 3753w	2948,60 4094w
VLV84/70	€	1424,30 920w	1511,30 1103w	1598,60 1287w	1683,50 1471w	1770,70 1655w	1857,50 1839w	1942,60 2023w	2029,60 2207w	2201,60 2575w	2373,30 2942w	2548,10 3310w	2719,70 3678w	2892,10 4046w	3066,10 4414w
VL84/35-2	€	1534,00 1034w	1625,70 1240w	1717,50 1447w	1808,90 1654w	1900,80 1860w	1992,40 2067w	2081,70 2274w	2173,10 2480w	2356,60 2894w	2538,50 3307w	2721,90 3721w	2903,20 4134w	3086,40 4547w	3269,70 4961w
VL84/70-2	€	1572,70 1154w	1673,10 1384w	1775,10 1615w	1875,60 1846w	1979,90 2076w	2081,70 2307w	2182,40 2538w	2284,00 2768w	2487,60 3230w	2691,40 3691w	2894,00 4153w	3099,90 4614w	3303,70 5075w	3505,70 5537w
V91	€	603,50 424w	641,30 509w	680,00 594w	717,40 678w	756,20 763w	794,30 848w	832,70 933w	872,60 1018w	946,80 1187w	1025,90 1357w	1103,20 1526w	1180,30 1696w	1256,80 1866w	1331,80 2035w
V91-2	€	1343,00 729w	1419,80 875w	1495,50 1021w	1573,60 1166w	1651,80 1312w	1727,40 1458w	1804,80 1604w	1880,50 1750w	2036,40 2041w	2190,00 2333w	2345,20 2624w	2497,70 2916w	2650,70 3208w	2806,70 3499w
V98	€	634,80 453w	677,90 544w	717,40 634w	758,00 725w	802,30 815w	841,60 906w	882,10 997w	925,30 1087w	1006,90 1268w	1090,40 1450w	1174,20 1631w	1258,30 1812w	1339,70 1993w	1424,30 2174w
V98-2	€	1408,80 780w	1493,30 936w	1576,10 1092w	1660,80 1248w	1740,70 1404w	1826,00 1560w	1908,50 1716w	1993,60 1872w	2158,40 2184w	2325,90 2496w	2491,70 2808w	2658,80 3120w	2824,10 3432w	2991,40 3744w
V112	€	714,80 514w	760,30 617w	809,10 720w	854,30 822w	901,70 925w	949,40 1028w	994,40 1131w	1043,40 1234w	1137,20 1439w	1230,90 1645w	1323,50 1850w	1419,80 2056w	1512,80 2262w	1606,50 2467w
V112-2	€	1569,00 879w	1663,20 1055w	1757,10 1231w	1852,30 1406w	1945,80 1582w	2038,60 1758w	2132,80 1934w	2225,20 2110w	2414,50 2461w	2599,60 2813w	2789,00 3164w	2976,20 3516w	3163,30 3868w	3352,20 4219w
V126	€	792,00 575w	845,30 690w	898,10 805w	949,40 920w	1002,30 1035w	1054,50 1150w	1108,60 1265w	1160,50 1380w	1264,90 1610w	1371,40 1840w	1475,60 2070w	1581,60 2300w	1686,60 2530w	1791,20 2760w
V126-2	€	1725,40 977w	1830,80 1172w	1934,80 1368w	2041,10 1563w	2145,10 1759w	2251,50 1954w	2356,60 2149w	2461,80 2345w	2671,10 2736w	2882,70 3126w	3092,30 3517w	3303,70 3908w	3513,80 4299w	3724,20 4690w
V140	€	865,50 638w	925,30 765w	983,20 893w	1043,40 1020w	1100,10 1148w	1160,50 1275w	1219,60 1403w	1278,50 1530w	1394,70 1785w	1512,80 2040w	1630,30 2295w	1748,90 2550w	1866,90 2805w	1984,40 3060w
V140-2	€	1873,80 1073w	1991,40 1288w	2107,80 1502w	2225,20 1717w	2343,20 1931w	2461,80 2146w	2579,50 2361w	2694,80 2575w	2931,30 3004w	3165,80 3434w	3401,70 3863w	3636,00 4292w	3870,30 4721w	4108,30 5150w

Δt different from 50 K: consult Technical data Brem

V horizontal panel

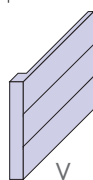

VL panel with fins

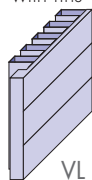

V-2 double panel

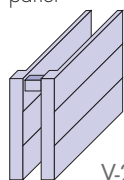

VLV double panel with fins

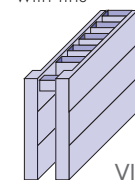

VL-2 double panel with double fins

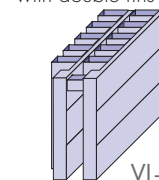

CAMEO

TOWEL RAILS & RADIATORS

design Davide Diliberto

A basic shape that's also highly decorative and versatile. Fits into a variety of different

settings. An extra tool for architects, letting them add a romantic, friendly or modern twist

to their projects, depending on the choice of colour and finish.

DIMENSIONS

Width: 54 cm

Height: 104/134/184/214 cm

Depth: 2,3 / 8,3 cm

Depth: from wall 5,8/11,8 cm

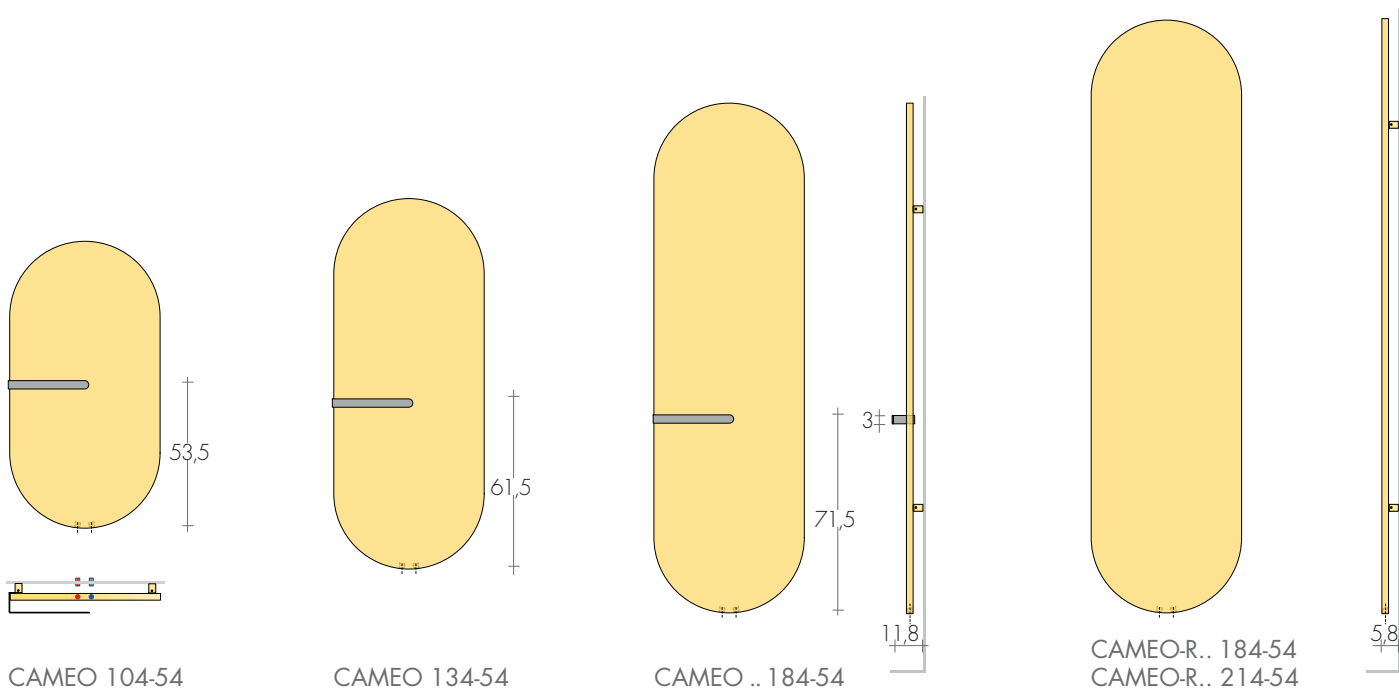

CAMEO 104-54

CAMEO 134-54

CAMEO .. 184-54

CAMEO-R.. 184-54
CAMEO-R.. 214-54

MODEL'25

	H/L cm	Standard white sablé SB 9016 €	Δt 50K watt	EN 442 Δt 40K watt	Δt 30K watt	▲ ▼ t.c. cm	Height H cm	Width L cm	Weight M Kg	Volume V dm³	DUAL FUEL VERSION with E.H.E. and * Watt €	
CAMEO	104-54	1049,30	500	379	263	5	104	54	15,8	6,9	500	105,60
CAMEO	134-54	1170,30	672	509	353	5	134	54	21,1	9,2	650	107,80
CAMEO	184-54	1342,40	958	725	504	5	184	54	30,0	13,2	900	116,20
CAMEO-L	184-54	1585,80	1300	984	684	5	184	54	40,8	16,5	1200	124,50
Models without towel bar - radiators												
CAMEO-R	184-54	1281,50	958	725	504	5	184	54	30,0	13,2	900	116,20
CAMEO-RL	184-54	1524,90	1300	984	684	5	184	54	40,8	16,5	1200	124,50
CAMEO-R	214-54	1382,20	1129	856	594	5	214	54	35,4	15,5	1200	124,50
CAMEO-RL	214-54	1822,70	1585	1201	834	5	214	54	49,8	19,8	1500	135,40

Towel bar on the right side, on request without extra

*Dual fuel valve or T to be added p.207
Thermostats p.208-209

Additional or deductible towel bar CAMEO
Art. MCA 60,90€

TOWEL BAR CAMEO: STANDARD COLORS
- white sablé SB 9016 - quartz grey SB 7039
- black sablé SB 9005 - same color as the radiator

In one paintwork to Brem color list different from the radiator
extra 52,90€

MAGNETIC ACCESSORIES p. 277



STANDARD PRODUCTION

White sablé paintwork SB9016, B35 brackets
Tolerance ± 3mm - Air vent ø 1/8"

MAXIMUM OPERATING PRESSURE 4 BAR

PRODUCTION ON REQUEST

Paintwork to BREM color list with colored
brackets +15/25%

Electric version e.Cameo, page 212

STANDARD FITTING

EG ø 3/8"

On request, free of charge,
fittings EG ø1/2", with 2 cm sleeves



TAPPING CENTRES
Hidden connections sleeve

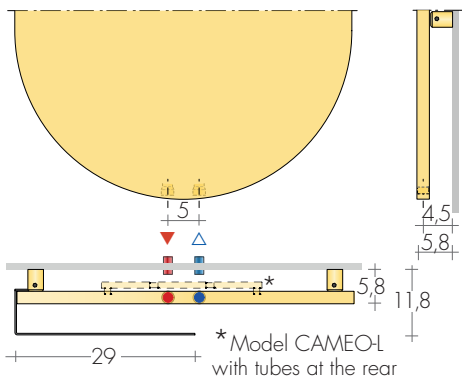

ENTRAXE RACCORDEMENTS ø1/2"
Fittings with 2cm sleeves

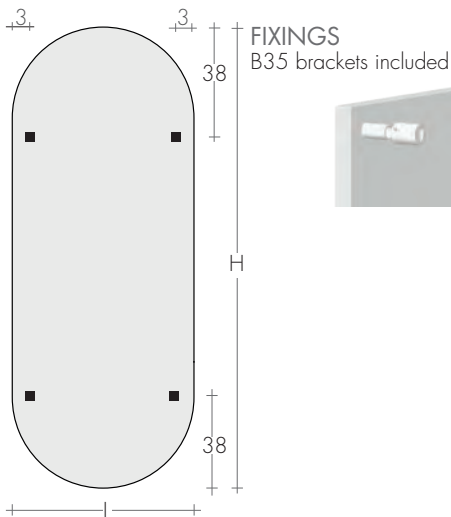
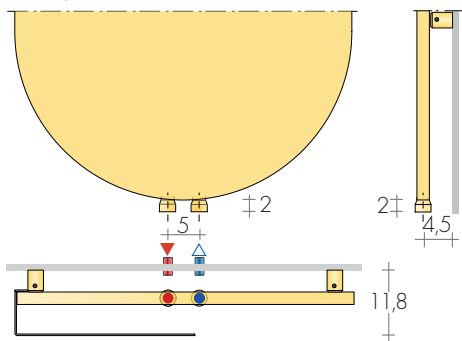

PANELS

RECOMMENDED VALVES

CHROME VALVES KIT with:

- n°2 Valves with chrome tailpieces
- n°2 Fittings (multilayer ø16, copper ø12, 14)
- n°2 Chrome wall plates ø 48, hole ø16

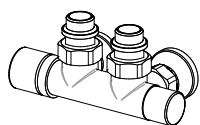

DUAL TUBE left CYL Valves KIT with Thermostatic option, ▲▼ 5 cm, pag. 273 Art. KCB 171,50€
Extra for BREM color list 53,40€

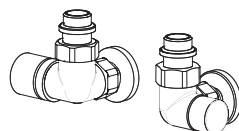

SIDE CONTROL CYL VALVES KIT with THERMOSTATIC option, page 273 Art. KCLD 162,50€
Extra for BREM color list 53,40€

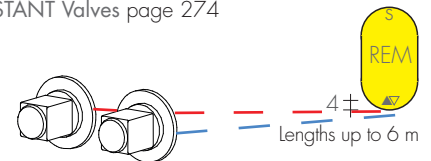

SPECIAL FINISHES page 267
Finishes Gold, Bronze, Brushed Nickel for 2 valves
Brushed Nickel FITTING KIT extra Art. RN 30,50€

REMOTE FITTINGS Art. REM 42,10€
Tapping centres: at the rear of radiator ▲▼ 5 cm
DISTANT Valves page 274

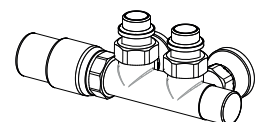

DUAL TUBE left Valve KIT with THERMOSTATIC Head, ▲▼ 5 cm, pag. 274 Art. KTB 201,50€
Special colors and finishes pag.266-267

CLARK

design Luigi Brembilla

Clark is an ultra-thin steel plate, just 2.3 cm thick, that has been cross cut asymmetrically

and set in a rectangular framework of steel tubes of similar thickness. The two elements

(standard colour: white) can be painted in any of the shades in the Brem colour list.

DIMENSIONS

L: Widths of the panel: 36 / 45 cm

L': Widths of the towel bar: 64/84/104/124 cm

Heights: 80/130 / 180 cm

Depth: 9 cm

Depth: from wall 12 cm

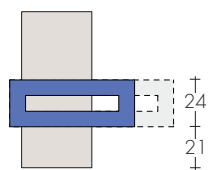
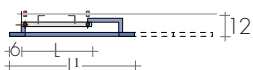

CLARK 80-36/...

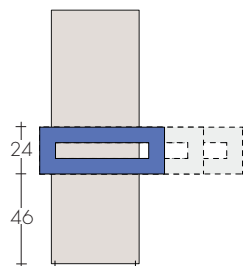

CLARK 130-45/...

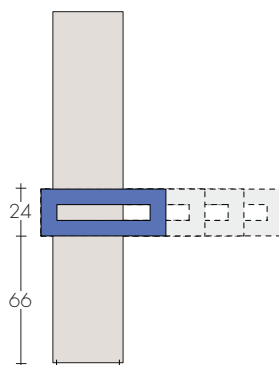

CLARK 180-36/...

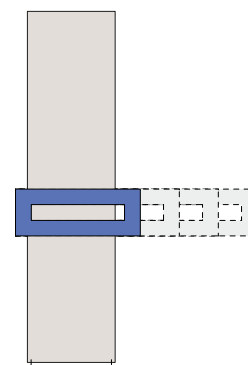

CLARK 180-45/...

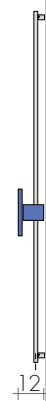

MODEL	H/L/L' cm	Standard white sablé SB9016 €	EN 442			▲ ▼ t.c. cm	Height H cm	Width L cm	Weight M Kg	Volume V dm ³	DUAL FUEL VERSION with E.H.E. and *	
			Δt 50K watt	Δt 40K watt	Δt 30K watt						Watt	€
CLARK	80-36/64	1102,40	479	366	252	32	80	36/64	12,2	5,2	500	105,60
CLARK	80-45/84	1233,10	601	459	316	41	80	45/84	15,2	6,2	650	107,80
CLARK	130-36/64	1233,00	676	512	356	32	130	36/64	17,8	7,1	650	107,80
CLARK	130-36/84	1263,70	720	545	379	32	130	36/84	18,7	7,6	650	107,80
CLARK	130-36/104	1298,20	764	578	402	32	130	36/104	19,5	8,1	650	107,80
CLARK	130-45/64	1364,30	801	606	421	41	130	45/64	21,2	7,9	800	112,60
CLARK	130-45/84	1396,10	845	640	444	41	130	45/84	22,1	8,4	800	112,60
CLARK	130-45/104	1431,70	889	673	468	41	130	45/104	22,9	8,9	900	116,20
CLARK	180-36/64	1431,60	872	660	459	32	180	36/64	23,4	8,9	900	116,20
CLARK	180-36/84	1463,30	916	693	482	32	180	36/84	24,3	9,4	900	116,20
CLARK	180-36/104	1498,60	960	727	505	32	180	36/104	25,1	9,9	900	116,20
CLARK	180-36/124	1547,30	1004	760	528	32	180	36/124	25,9	10,5	900	116,20
CLARK	180-45/64	1527,10	1045	791	550	41	180	45/64	28,1	10,0	900	116,20
CLARK	180-45/84	1559,00	1089	824	573	41	180	45/84	29,0	10,5	1200	124,50
CLARK	180-45/104	1594,80	1133	858	596	41	180	45/104	29,8	11,0	1200	124,50
CLARK	180-45/124	1642,90	1177	891	619	41	180	45/124	30,6	11,6	1200	124,50

Extra for towel bar in different color from panel
Art. CMC 74,50€

*Dual fuel valve or T to be added p.207
Thermostats p.208-209

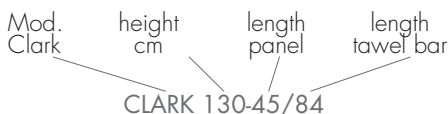

MAGNETIC ACCESSORIES p. 277

STANDARD PRODUCTION

White sablé paintwork SB9016, B35 brackets
Tolerance ± 3mm - Air vent ø 1/8"

MAXIMUM OPERATING PRESSURE 4 BAR

PRODUCTION ON REQUEST

Paintwork to BREM color list with colored
brackets

+15/25%
Bar protrusion on the left without supplement

STANDARD FITTING

EG ø 3/8"
Special fittings, page 278

Electric version e.Clark, page 217



TAPPING CENTRES

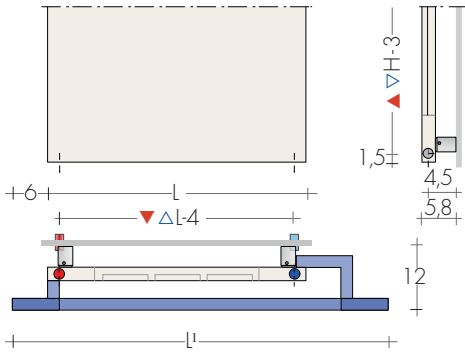

Side fittings on request
Extra

Art. AS 91,20€



Fitting \varnothing 3/8"
STANDARD
(without sleeves)



Fitting \varnothing 1/2"
ON REQUEST
(with sleeves)

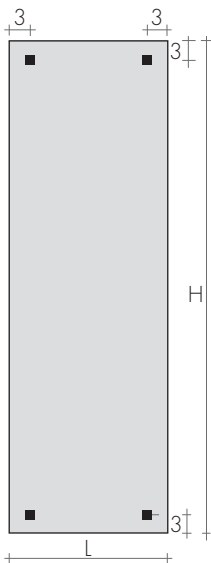

FIXINGS
Brackets included



B35 bracket



CLARK 180-45/104

RECOMMENDED VALVES

CHROME VALVES KIT with:

- n°2 Valves with chrome tailpieces
- n°2 Fittings (multilayer \varnothing 16, copper \varnothing 12, 14)
- n°2 Chrome wall plates \varnothing 48, hole \varnothing 16

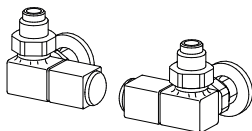

SIDE CONTROL QUADRA VALVES KIT
page 271

Art. KQL 191,20€

Extra for BREM color list

53,40€

SPECIAL FINISHES

Finishes Gold, Bronze, Brushed Nickel for 2 valves
Brushed Nickel FITTING KIT extra Art. RN 30,50€

page 267

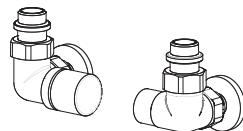

SIDE CONTROL CYL VALVES KIT with THERMO-
STATIC option, page 273

Art. KCL 162,50€

Extra for BREM color list

53,40€

REMOTE FITTINGS

Art. REM 42,10€
Tapping centres: at the rear \blacktriangle \blacktriangledown EG L-5 cm
DISTANT Valves page 274

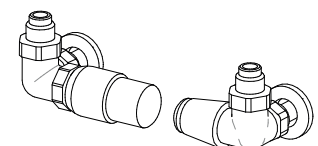
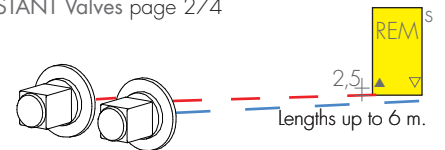

SIDE CONTROL CYL chrome VALVES TON with
thermostatic head, p.269

Art. KTL 203,70€

CUBICO

design Luigi Brembilla

Essential, light, and eclectic in design, CUBICO is the Brem towel warmer

where the minimalism and elegance of the radiating plate are enhanced by the

playful and versatile insertion of a cubic or parallelepiped shaped support.

DIMENSIONS

Length: 44/49/54 cm

Heights: 80,5/96,5/124,5/148,5/152,5/168,5/180,5 cm

Depth: 11 cm

Depth from wall: 14 cm

CUBICO-2 with double towel bar

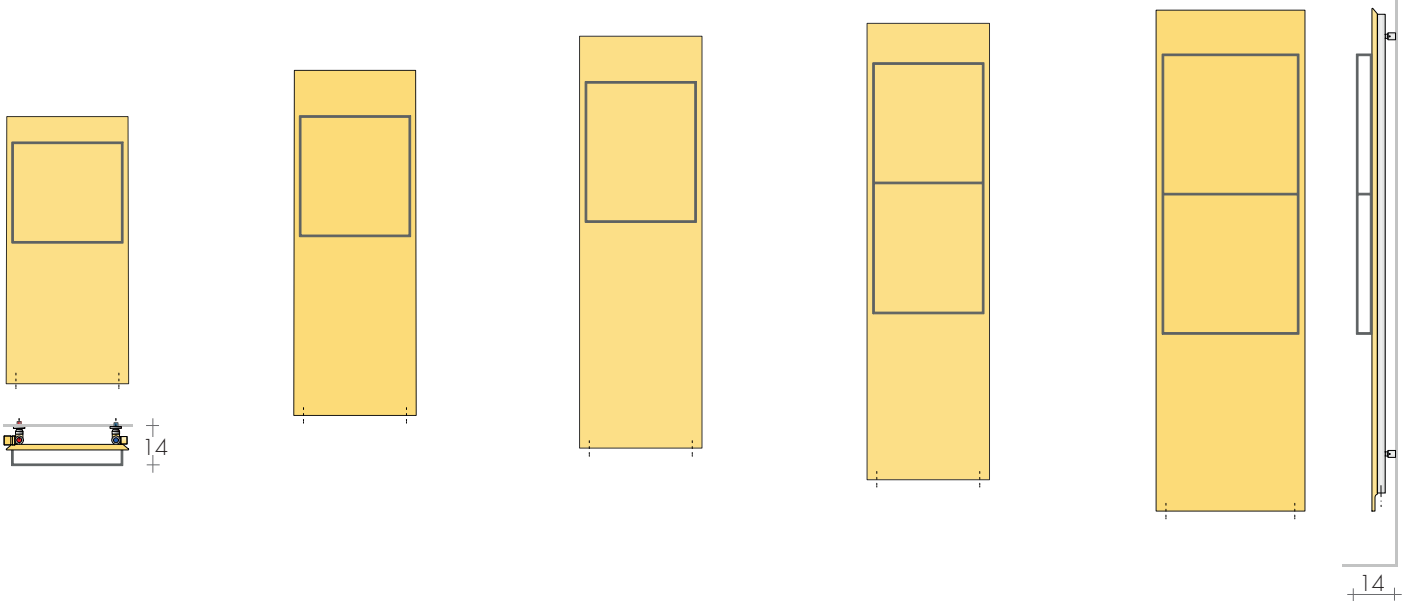

CUBICO 80-44
CUBICO 96-44

CUBICO 124-44

CUBICO 148-44
CUBICO 168-44

CUBICO-2 168-44

CUBICO-2 152-49
CUBICO-2 180-54

MODEL'25

	H/L cm	Standard white sablé SB9016 €	Δt 50K watt	EN 442 Δt 40K watt	Δt 30K watt	▲ ▼ t.c. cm	Height H cm	Width L cm	Weight M Kg	Volume V dm ³	DUAL FUEL VERSION with E.H.E. and * Watt €	
CUBICO	80-44	708,70	409	309	215	35	80,5	44	10,5	3,1	400	103,40
CUBICO	96-44	785,10	500	378	263	35	96,5	44	12,7	3,8	500	105,60
CUBICO	124-44	870,10	659	498	347	35	124,5	44	16,6	5,1	650	107,80
CUBICO	148-44	944,30	796	601	419	35	148,5	44	19,8	6,1	800	112,60
CUBICO	168-44	1006,40	909	686	478	35	168,5	44	22,7	7,0	900	116,20
CUBICO-2	168-44	1040,00	909	686	478	35	168,5	44	23,1	7,0	900	116,20
CUBICO-2	152-49	1026,30	901	680	474	40	152,5	49	23,0	6,9	900	116,20
CUBICO-2	180-54	1211,50	1175	887	618	45	180,5	54	29,5	8,9	1200	124,50

*Add mixed valve p.207
Thermostats p.208-209

TOWEL BAR GEO: STANDARD COLORS

- white sablé SB 9016 - quartz grey SB 7039
- black sablé SB 9005 - same color as the radiator

In one paintwork to Brem color list different from the radiator
extra 52,90€



STANDARD PRODUCTION

White sablé paintwork SB9016 brackets white
Tolerance ± 3mm - Air vent ø 1/8"

MAXIMUM OPERATING PRESSURE 4 BAR

PRODUCTION ON REQUEST

Paintwork to Brem list with colored brackets
+15/25%

Electrical version, eCubico p. 223

STANDARD FITTING

EG ø 1/2"

Special fittings, page 278

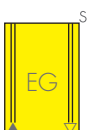

TAPPING CENTRES

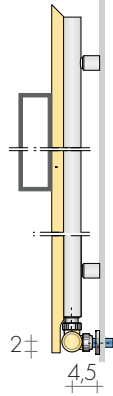
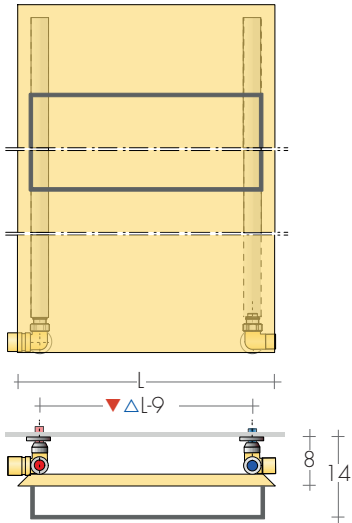

DUAL FUEL VERSION



With valve/lockshield Mixed G50 brackets

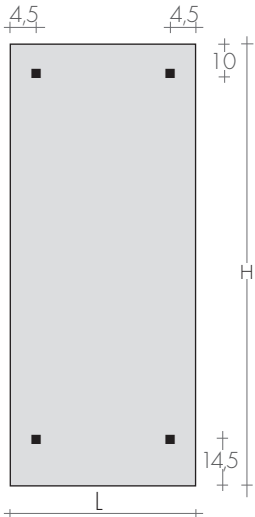
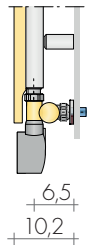

FIXINGS
G30 brackets
included



RECOMMENDED VALVES

CHROME VALVES KIT with:

- n°2 Valves with chrome tailpieces
- n°2 Fittings (multilayer $\varnothing 16$, copper $\varnothing 12, 14$)
- n°2 Chrome wall plates $\varnothing 48$, hole $\varnothing 16$

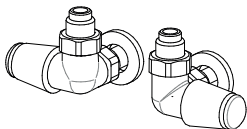

SIDE CONTROL TON VALVES KIT nickel-plated chrome-plated handwheel Art. KVLN 104,80€

SIDE CONTROL chrome TON VALVES KIT page 269 Art. KVL 130,90€

SPECIAL FINISHES

page 267
Finishes Gold, Bronze, Brushed Nickel for 2 valves
Brushed Nickel FITTING KIT extra Art. RN 30,50€

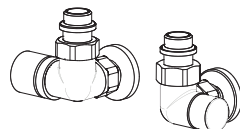

SIDE CONTROL CYL VALVES KIT with THERMOSTATIC option, page 273 Art. KCLD 162,50€
Extra for BREM color list 53,40€

BICOLOR SOLUTION:

BIC10 Cover in a Brem color and back radiator white sablé SB9016 +10%
BIC20 Cover in a Brem color and back radiator black sablé SB9005 or grey sablé SB7039 +20%
BIC35 N° 2 Brem colors of your choice +35%

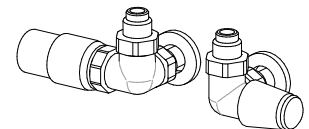

SIDE CONTROL nickel-plated ON VALVES KIT with thermostatic Head Art. KTLND 161,10€

SIDE CONTROL chrome TON VALVES KIT with thermostatic head, p.269 Art. KTLD 203,70€

DUO

design Luigi Brembilla

DUO is a towel warmer composed of two square radiant plates joined by a round

collector. The minimal thickness of the plates, their tapered profile and hidden valves,

make this collection light and elegant.

DIMENSIONS

Length: 44/49/54/59 cm

Heights: 100,5/116,5/124,5/132,5 cm

Depth: 5,2 cm

Depth from wall: 8,2 cm

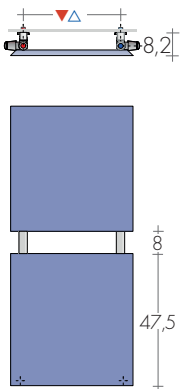

DUO 101-44

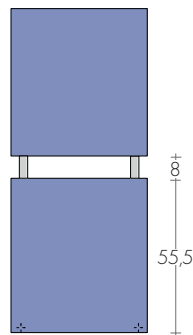

DUO 117-49

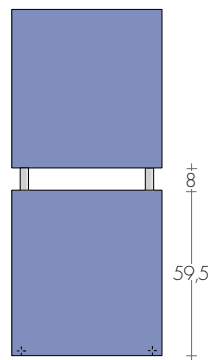

DUO 125-54

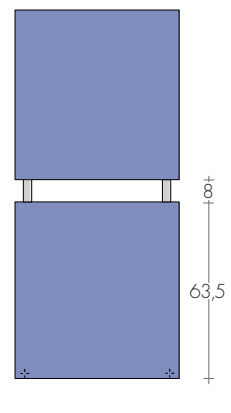

DUO 133-59

MODEL	H/L cm	Standard white sablé SB 9016 €	EN 442			▲ ▽ t.c. cm	Height H cm	Width L cm	Weight M Kg	Volume V dm ³	DUAL FUEL VERSION with E.H.E. and *	
			Δt 50K watt	Δt 40K watt	Δt 30K watt						Watt	€
DUO	101-44	685,90	486	367	256	35	100,5	44	12,5	3,8	500	105,60
DUO	117-49	820,20	634	479	333	40	116,5	49	16,3	4,9	650	107,80
DUO	125-54	878,50	747	564	393	45	124,4	54	19,1	5,7	800	112,60
DUO	133-59	918,70	868	655	457	50	132,5	59	22,2	6,5	900	116,20

* Add mixed valve p.207
Thermostats p.208-209

BICOLOR SOLUTION:

BIC10 Cover in a Brem color and back radiator
white sablé SB9016 +10%

BIC20 Cover in a Brem color and back radiator
black sablé SB9005 or grey sablé SB7039 +20%

BIC35 N° 2 Brem colors of your choice +35%

STANDARD PRODUCTION

White sablé SB9016 paintwork brackets white
Tolerance ± 3mm - Air vent ø 1/2"

MAXIMUM OPERATING PRESSURE 6 BAR

PRODUCTION ON REQUEST

Paintwork to Brem list with colored brackets
+15/25%

Electrical version, e.Cubico p. 224

STANDARD FITTING

EG ø 1/2"

Use side control valve

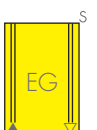

TAPPING CENTRES

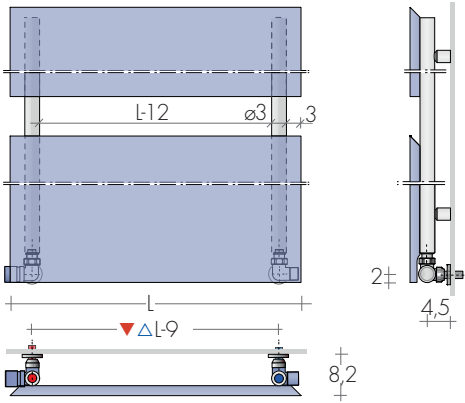

DUAL FUEL VERSION

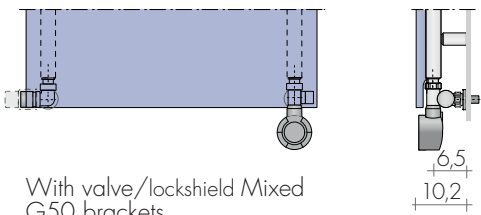

With valve/lockshield Mixed G50 brackets

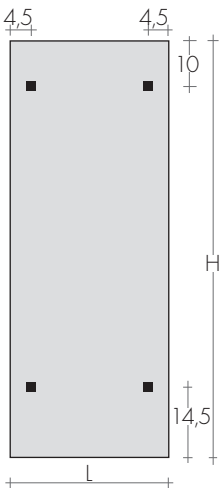

FIXINGS
G30 brackets
included

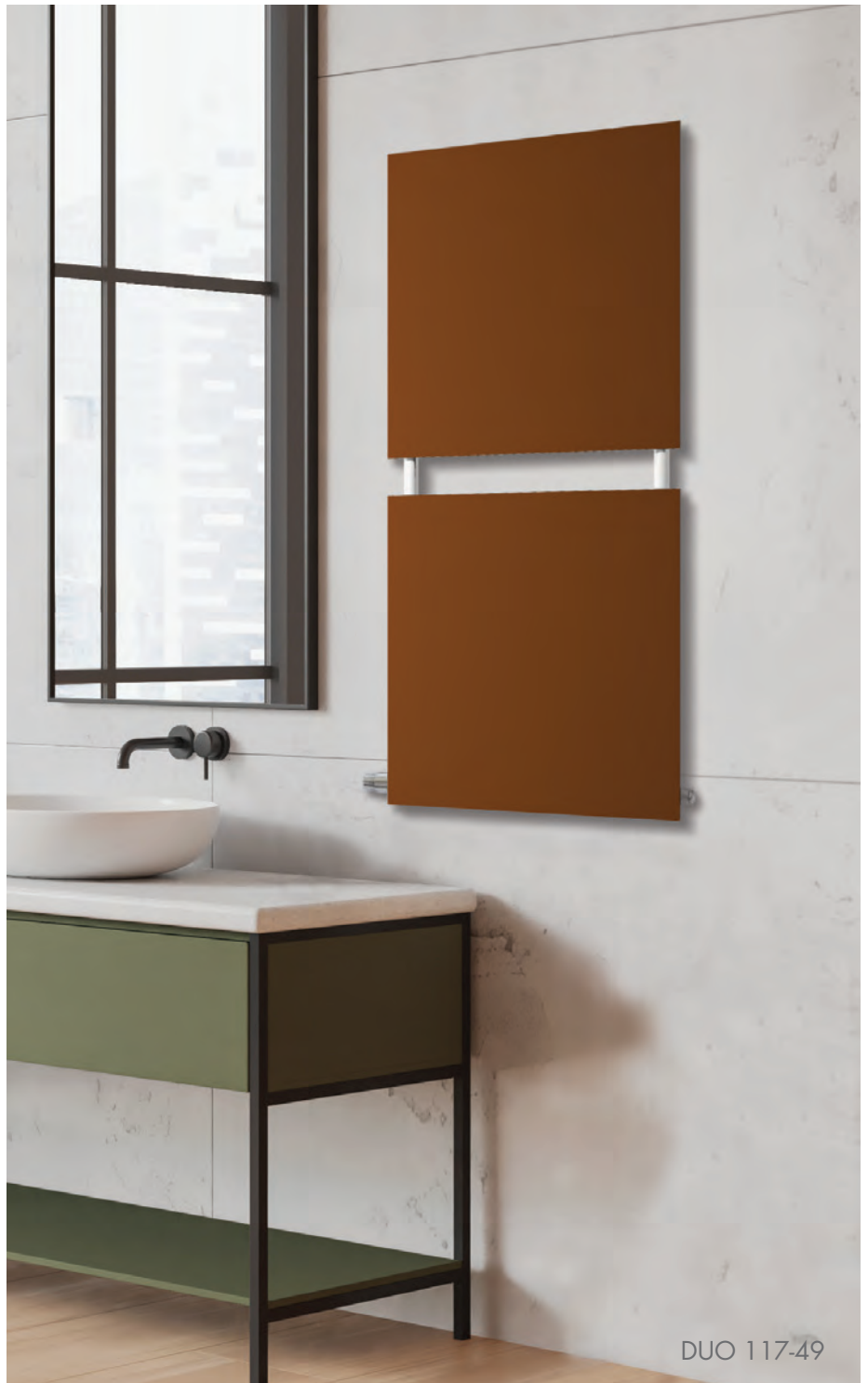

DUO 117-49

RECOMMENDED VALVES

CHROME VALVES KIT with:

- n°2 Valves with chrome tailpieces
- n°2 Fittings (multilayer ø16, copper ø12, 14)
- n°2 Chrome wall plates ø 48, hole ø16

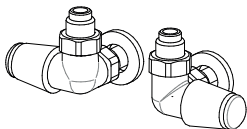

SIDE CONTROL TON VALVES KIT nickel-plated chrome-plated handwheel Art. KVLN 104,80€
SIDE CONTROL TON VALVES KIT chrome page 269 Art. KVL 130,90€

SPECIAL FINISHES

page 267

Finishes Gold, Bronze, Brushed Nickel for 2 valves
Brushed Nickel FITTING KIT extra Art. RN 30,50€

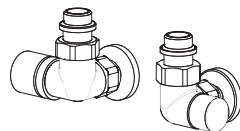

SIDE CONTROL CYL VALVES KIT with THERMOSTATIC option, page 273 Art. KCLD 162,50€
Extra for BREM color list 53,40€

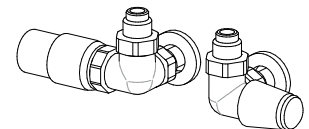

SIDE CONTROL nickel-plated ON VALVES KIT with thermostatic Head Art. KTIND 161,10€
SIDE CONTROL chrome TON VALVES KIT with thermostatic head, p.269 Art. KTLD 203,70€

FLAG

design Luigi Brembilla

Built with a sober and smooth new radiating plate, FLAG also features a special

towel warmer with rails in the shape of the flags that distinguish its design.

The towel rail can be personalized with exclusive finishes in the Brem color range.

DIMENSIONS

Length: 44 cm

Heights: 80,5/96,5/124,5/148,5/168,5 cm

Depth: 11 cm

Depth from wall: 14 cm

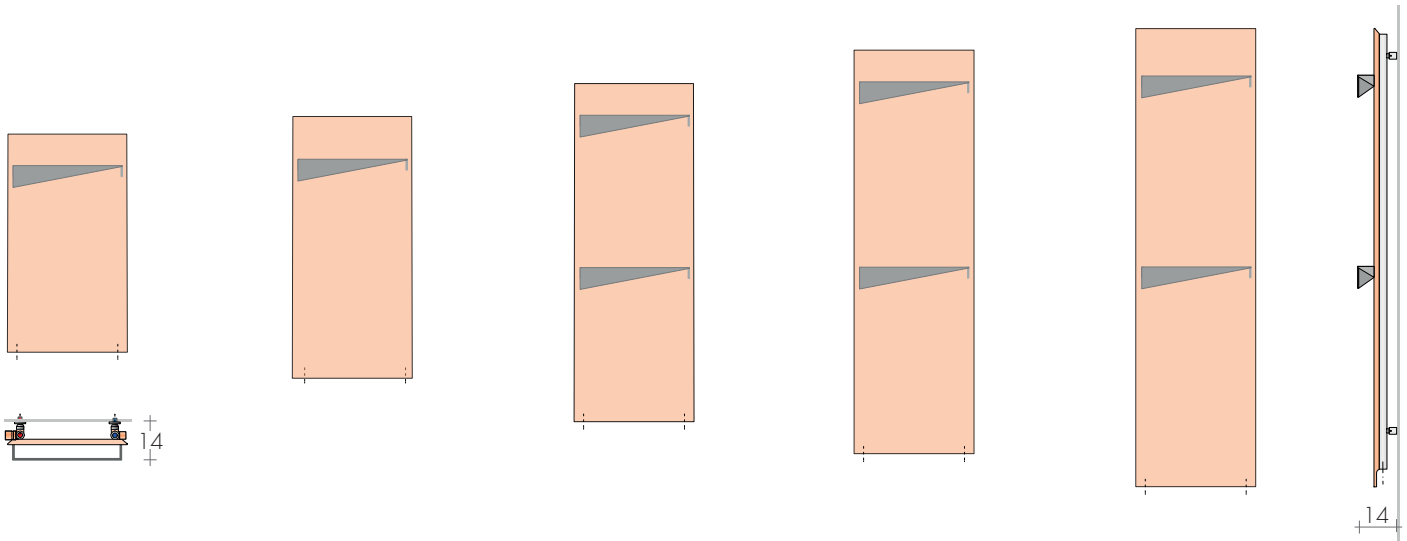

FLAG 80-44

FLAG 96-44

FLAG 124-44

FLAG 148-44

FLAG 168-44

MODEL'25

	HL cm	Standard white sablé SB9016 €	Δt 50K watt	EN 442 Δt 40K watt	Δt 30K watt	▲ ▽ t.c. cm	Height H cm	Width L cm	Weight M Kg	Volume V dm ³	DUAL FUEL VERSION with E.H.E. and * Watt €	
FLAG	80-44	668,40	409	309	215	35	80,5	44	10,7	3,1	400	103,40
FLAG	96-44	744,80	500	378	263	35	96,5	44	12,9	3,8	500	105,60
FLAG	124-44	890,30	659	498	347	35	124,5	44	17,4	5,1	650	107,80
FLAG	148-44	964,40	796	601	419	35	148,5	44	20,6	6,1	800	112,60
FLAG	168-44	1026,60	909	686	478	35	168,5	44	23,3	7,0	900	116,20

*Add mixed valve p.207
Thermostats p.208-209

TOWEL BAR FLAG: STANDARD COLORS

- white sablé SB 9016 - quartz grey SB 7039
- black sablé SB 9005 - same color as the radiator

In one paintwork to Brem color list different from the radiator extra 52,90€



STANDARD PRODUCTION

White sablé SB9016 paintwork brackets white
Tolerance \pm 3mm - Air vent \varnothing 1/2"

MAXIMUM OPERATING PRESSURE 6 BAR

PRODUCTION ON REQUEST

Paintwork to Brem list with colored brackets
+15/25%

Electrical version, e.Flag p. 227

STANDARD FITTING

EG \varnothing 1/2"

Use side control valve

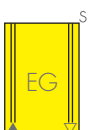

TAPPING CENTRES

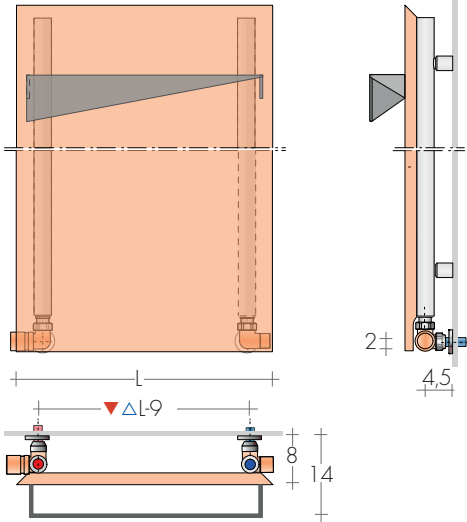

DUAL FUEL VERSION p.207

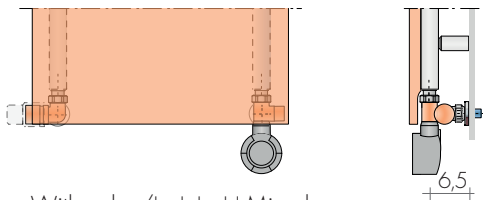

With valve/lockshield Mixed G50 brackets

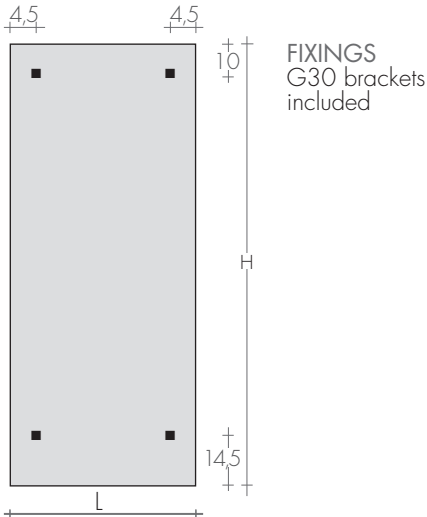

RECOMMENDED VALVES

CHROME VALVES KIT with:

- n°2 Valves with chrome tailpieces
- n°2 Fittings (multilayer ø16, copper ø12, 14)
- n°2 Chrome wall plates ø 48, hole ø16

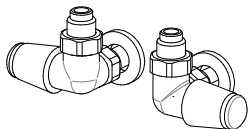

SIDE CONTROL TON VALVES KIT nickel-plated chrome-plated handwheel Art. KVLN 104,80€
SIDE CONTROL chrome TON VALVES KIT page 269 Art. KVL 130,90€

SPECIAL FINISHES

page 267
Finishes Gold, Bronze, Brushed Nickel for 2 valves
Brushed Nickel FITTING KIT extra Art. RN 30,50€

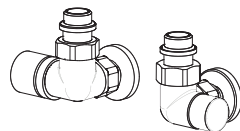

SIDE CONTROL CYL VALVES KIT with THERMOSTATIC option, page 273 Art. KCLD 162,50€
Extra for BREM color list 53,40€

BICOLOR SOLUTION:

BIC10 Cover in a Brem color and back radiator white sablé SB9016 +10%
BIC20 Cover in a Brem color and back radiator black sablé SB9005 or grey sablé SB7039 +20%
BIC35 N° 2 Brem colors of your choice +35%

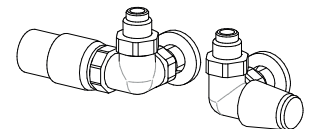

SIDE CONTROL nickel-plated ON VALVES KIT with thermostatic Head Art. KTLND 161,10€
SIDE CONTROL chrome TON VALVES KIT with thermostatic head, p.269 Art. KTLD 203,70€



GEOMETRICA TONDA - OVALE

design Luigi Brebilla

Geometrica is a collection of heated towel rails with geometric elements and a distinctive horizontal bar passing through them. The towel rail bar can also be designed to extend to the left of the main radiator.

extend to the left of the main radiator.

TONDA Geo-T MODEL

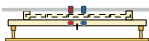

*Geo-TL model
with tubes at the rear

OVALE Geo-O MODEL



*Geo-OL model
with tubes at the rear

OVALE-V Geo-OV MODEL



*Geo-OVL model
with tubes at the rear

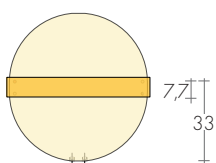

Geo-T.. 58-56

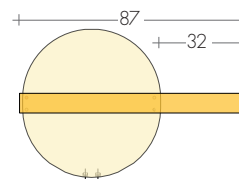

Geo-T.. 58-87

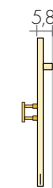

11.8

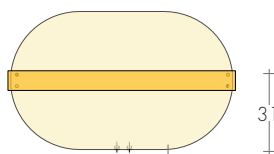

Geo-O.. 54-89

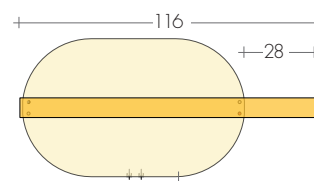

Geo-O.. 54-116

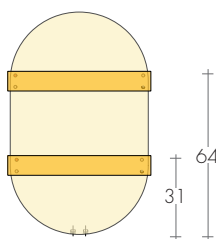
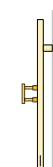

Geo-OV.. 87-56

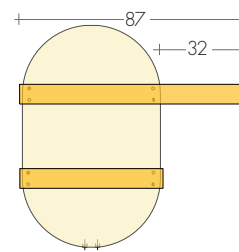

Geo-OV.. 87-87



MODEL	H-L cm	Standard white sablé SB 9016 €	EN 442			▲ ▽ t.c. cm	Height H cm	Width L cm	Weight M Kg	Volume V dm ³	DUAL FUEL VERSION with E.H.E. and sleeve*	
			Δt 50K watt	Δt 40K watt	Δt 30K watt						Watt	€
Geo-T	58-56	893,80	312	237	164	5	58	56	9,2	3,7	*250	101,10
Geo-TL	58-56	1093,70	449	341	236	5	58	56	13,5	5,0	*400	103,40
Geo-T	58-87	923,20	344	261	181	5	58	87	9,8	3,9	*400	103,40
Geo-TL	58-87	1123,10	481	365	253	5	58	87	14,1	5,2	*500	105,60
Geo-O	54-89	952,60	514	391	270	5	54	89	15,0	6,2	500	129,60
Geo-OL	54-89	1152,50	734	558	386	5	54	89	21,9	8,3	650	131,80
Geo-O	54-116	993,80	543	413	286	5	54	116	15,5	6,3	500	129,60
Geo-OL	54-116	1193,70	763	580	401	5	54	116	22,4	8,4	800	136,60
Geo-OV	87-56	1070,20	539	410	284	5	87	56	15,4	6,3	*500	105,60
Geo-OVL	87-56	1270,10	759	577	399	5	87	56	22,3	8,4	*800	112,60
Geo-OV	87-87	1099,60	571	434	300	5	87	87	16,0	6,5	*650	107,80
Geo-OVL	87-87	1299,50	791	601	416	5	87	87	22,9	8,6	*800	112,60

On request, free of charge,
towel bar with the left extension

*Add mixed valve p.207
Thermostats p.208-209

TOWEL BAR GEO: STANDARD COLORS

- white sablé SB 9016
- quartz grey SB 7039
- black sablé SB 9005
- same color as the radiator

In one paintwork to Brem color list different from the radiator
extra 52,90€



STANDARD PRODUCTION

White sablé SB9016 paintwork brackets white
Tolerance ± 3mm - Air vent ø 1/8"
MAXIMUM OPERATING PRESSURE 4 BAR

PRODUCTION ON REQUEST

Paintwork to Brem color list (colored B15
brackets) +15/25%
Electric version e.Geo-T..O..OV p.230

STANDARD FITTING

EG ø 3/8"
On request, free of charge,
fittings EG ø1/2", with 2 cm sleeves



TAPPING CENTRES

Standard EG \varnothing 3/8", hidden sleeves

Model Geo-T.. Geo-OV..

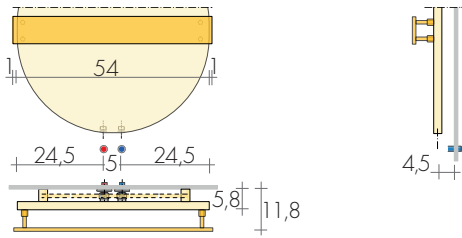

Model Geo-O..

*E.H.E.

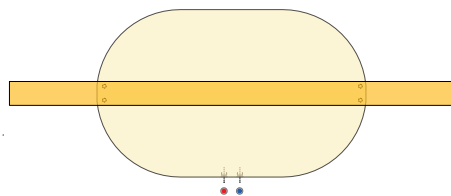
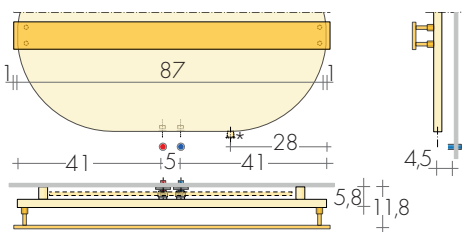

Mod. Geo-O 54-143 (571W) € 1034,90

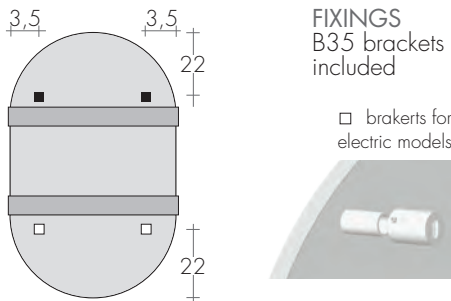

FIXINGS
B35 brackets
included

brackets for
electric models

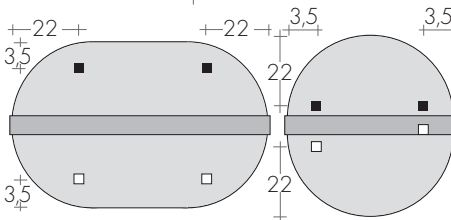

RECOMMENDED VALVES

CHROME VALVES KIT with:

- n°2 Valves with chrome tailpieces
- n°2 Fittings (multilayer \varnothing 16, copper \varnothing 12, 14)
- n°2 Chrome wall plates \varnothing 48, hole \varnothing 16

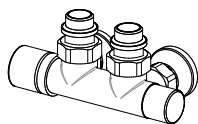

DUAL TUBE left CYL Valves KIT with Thermostatic
option, \blacktriangle \blacktriangledown 5 cm, pag. 273 Art. KCB 171,50€
Extra for BREM color list 53,40€

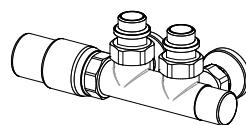

DUAL TUBE left Valve KIT with THERMOSTATIC
Head, \blacktriangle \blacktriangledown 5 cm, pag. 274 Art. KTB 201,50€
Special colors and finishes pag.266-267

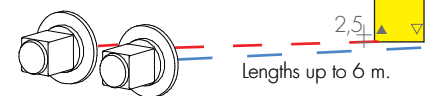

Lengths up to 6 m.

SPECIAL FINISHES page 267
Finishes Gold, Bronze, Brushed Nickel for 2 valves
Brushed Nickel FITTING KIT extra Art. RN 30,50€

REMOTE FITTINGS Art. REM 42,10€
Tapping centres: at the rear of radiator \blacktriangle \blacktriangledown 5 cm
DISTANT Valves page 274

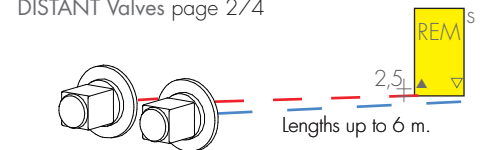

Lengths up to 6 m.

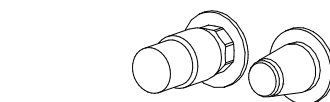

REMOTE TON VALVES KIT with THERMOSTATIC
head, pag. 274 Art. KVGT 229,80€



Geo-T 58-56

with remote fittings

GEOMETRICA QUADRA - RETTANGOLARE

design Luigi Brembilla

The Geometrica collection also includes the Quadra and Rettangolare models. The "L" models have tubes at the rear to increase heat output. Upon request, the towel rail

bar can be supplied with the left extension of the heated towel rail.

QUADRA Geo-Q MODEL

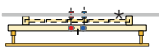

*Geo-QL model with tubes at the rear

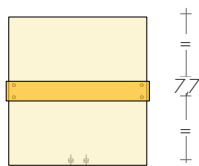

Geo-Q..58-56 / 67-65 / 76-74

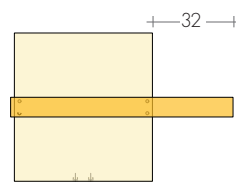

Geo-Q.. 58-87/67-102 / 76-116

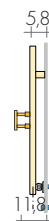

RETTANGOLARE- Geo-R MODEL

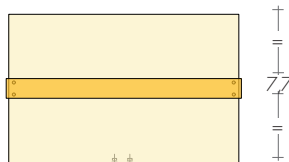

Geo-R 54-92 / 63-102

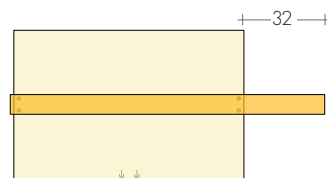

Geo-R 54-123 / 63-138

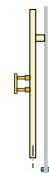

RETTANGOLARE VERTICALE Geo-RV MODEL



*Geo-RVL model with tubes at the rear

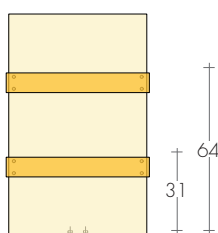

Geo-RV.. 87-56

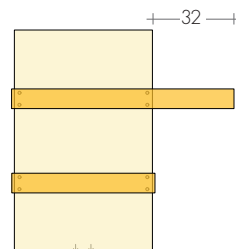

Geo-RV.. 87-87



MODEL	HL cm	Standard white sablé SB 9016 €	EN 442			▲ ▼ t.c. cm	Height H cm	Width L cm	Weight M Kg	Volume V dm ³	DUAL FUEL VERSION with E.H.E. and sleeve*	
			Δt 50K watt	Δt 40K watt	Δt 30K watt						Watt	€
Geo-Q	58-56	946,70	411	312	216	5	58	56	11,6	3,7	400	127,40
Geo-QL	58-56	1146,70	525	399	276	5	58	56	15,2	4,8	500	129,60
Geo-Q	58-87	976,10	444	337	234	5	58	87	12,1	3,9	400	127,40
Geo-QL	58-87	1164,20	558	424	294	5	58	87	15,7	5,0	500	129,60
Geo-Q	67-65	1009,00	540	410	284	5	67	65	15,2	4,7	500	129,60
Geo-QL	67-65	1244,20	708	538	372	5	67	65	20,5	6,3	650	131,80
Geo-Q	67-102	1044,30	579	440	305	5	67	102	15,9	4,9	500	129,60
Geo-QL	67-102	1273,70	747	568	393	5	67	102	21,2	6,5	800	136,60
Geo-Q	76-74	1070,20	685	520	360	5	76	74	19,3	5,8	650	131,80
Geo-QL	76-74	1340,60	918	697	483	5	76	74	26,6	8,0	800	136,60
Geo-Q	76-116	1111,40	729	554	383	5	76	116	20,0	6,0	650	131,80
Geo-QL	76-116	1381,90	962	731	506	5	76	116	27,3	8,2	800	136,60
Geo-R	54-92	1039,60	635	482	334	5	54	92	17,7	5,4	650	131,80
Geo-R	54-123	1080,80	668	508	351	5	54	123	24,1	7,4	650	131,80
Geo-R	63-102	1186,00	802	609	422	5	63	102	22,4	6,7	800	136,60
Geo-R	63-138	1227,20	840	638	442	5	63	138	31,3	9,3	800	136,60
Geo-RV	87-56	1064,30	639	486	336	5	87	56	17,5	5,4	650	131,80
Geo-RVL	87-56	1264,30	819	622	431	5	87	56	23,2	7,1	800	136,60
Geo-RV	87-87	1093,70	671	510	353	5	87	87	18,1	5,6	650	131,80
Geo-RVL	87-87	1281,80	851	647	448	5	87	87	23,8	7,3	800	136,60

On request, free of charge, towel bar with the left extension

Thermostats p.208-209

TOWEL BAR GEO: STANDARD COLORS

- white sablé SB 9016
- quartz grey, SB 7039
- black sablé SB 9005
- same color as the radiator

In one paintwork to Brem color list different from the radiator extra 52,90€



Fitting ø 3/8"
STANDARD
(without sleeves)



Fitting ø 1/2"
ON REQUEST
(with sleeves)

STANDARD PRODUCTION

White sablé SB9016 paintwork brackets white
Tolerance ± 3mm - Air vent ø 1/8"
MAXIMUM OPERATING PRESSURE 4 BAR

PRODUCTION ON REQUEST

Paintwork to Brem color list (colored B15
brackets) +15/25%
Electric version, e.Geo-Q..-R..RV.. p.231

STANDARD FITTING

EG ø 3/8"
On request, free of charge, fittings
EG ø 1/2", with 2 cm sleeves



TAPPING CENTRES

Standard EG \varnothing 3/8", hidden sleeves

Model Geo-Q.. Geo-RV..

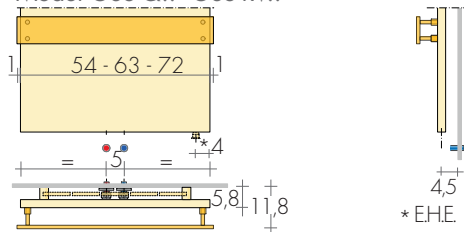

Model Geo-R

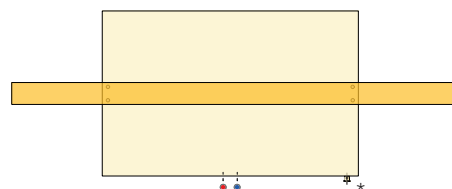
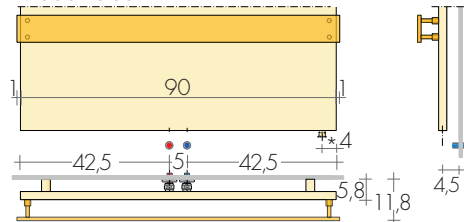

Mod. Geo-R 54-154 (701W) € 1121,90

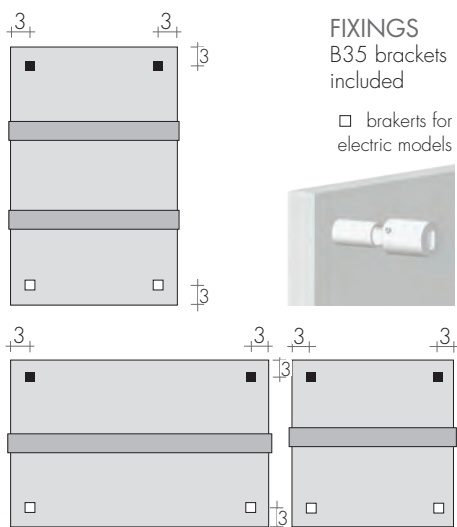

RECOMMENDED VALVES

CHROME VALVES KIT with:

- n°2 Valves with chrome tailpieces
- n°2 Fittings (multilayer \varnothing 16, copper \varnothing 12, 14)
- n°2 Chrome wall plates \varnothing 48, hole \varnothing 16

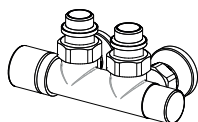

DUAL TUBE left CYL Valves KIT with Thermostatic option, \blacktriangle \blacktriangledown 5 cm, pag. 273 Art. KCB 171,50€
Extra for BREM color list 53,40€

SPECIAL FINISHES

page 267
Finishes Gold, Bronze, Brushed Nickel for 2 valves
Brushed Nickel FITTING KIT extra Art. RN 30,50€

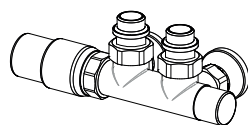

DUAL TUBE left Valve KIT with THERMOSTATIC Head, \blacktriangle \blacktriangledown 5 cm, pag. 274 Art. KTB 201,50€
Special colors and finishes pag.266-267

REMOTE FITTINGS

with remote fittings
Art. REM 42,10€
Tapping centres: at the rear of radiator \blacktriangle \blacktriangledown 5 cm
DISTANT Valves page 274

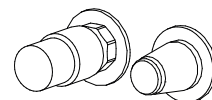
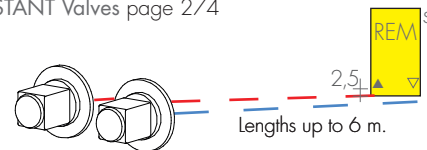

REMOTE TON VALVES KIT with THERMOSTATIC head, pag. 274 Art. KVGT 229,80€



Geo-Q 67-65

HOT

design Fiorenzo Mussi

With its precise linear design, Hot focuses on monochromatic synthesis, using light as

a dynamic element to highlight its name, formed by the letters H and T in relief and by

the play of the heated towel rail that creates the O. HOT is made with tapered edges.

DIMENSIONS

Length: 54 cm

Heights: 84,5/104,5/128,5/140,5/180,5 cm

Depth: 11 cm

Depth from wall: 8 / 14 cm

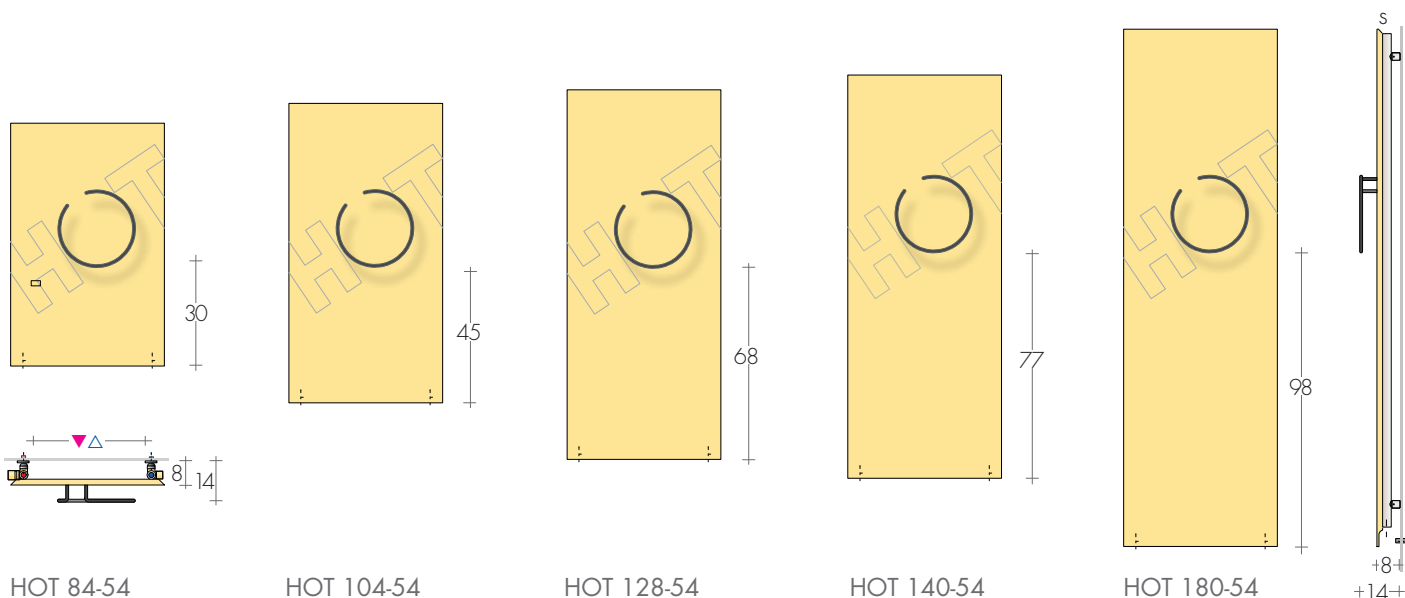

MODEL'25

	H-L cm	Standard white sablé SB 9016 €	Δt 50 K watt	EN 442 Δt 40 K watt	Δt 30 K watt	▲ ▽ t.c. cm	Height H cm	Width L cm	Weight M Kg	Volume V dm ³	DUAL FUEL VERSION with E.H.E. and* Watt €	
HOT	84-54	762,70	519	392	273	45	84,5	54	13,2	3,9	500	105,60
HOT	104-54	805,20	656	495	345	45	104,5	54	16,4	4,9	650	107,80
HOT	128-54	858,90	820	619	431	45	128,5	54	20,5	6,2	800	112,60
HOT	140-54	921,90	902	681	474	45	140,5	54	22,4	6,8	900	116,20
HOT	180-54	1155,50	1175	887	618	45	180,5	54	28,9	8,9	1200	124,50

*Add mixed valve p.207
Thermostats p.208-209

TOWEL BAR HOT: STANDARD COLORS

- white sablé SB 9016
- quartz grey SB 7039
- metal gold BR 0019
- black sablé SB 9005
- same color as the radiator

In one paintwork to Brem color list different from the radiator
extra 52,90€



STANDARD PRODUCTION

White sablé SB9016 paintwork, G30 brackets
Tolerance \pm 3mm - Air vent \varnothing 1/2"

MAXIMUM OPERATING PRESSURE 6 BAR

PRODUCTION ON REQUEST

Paintwork to Brem list with colored brackets
+15/25%

Electrical version, on request

STANDARD FITTING

EG \varnothing 1/2"

Use side control valve



TAPPING CENTRES

Hidden tapings with side control valves.

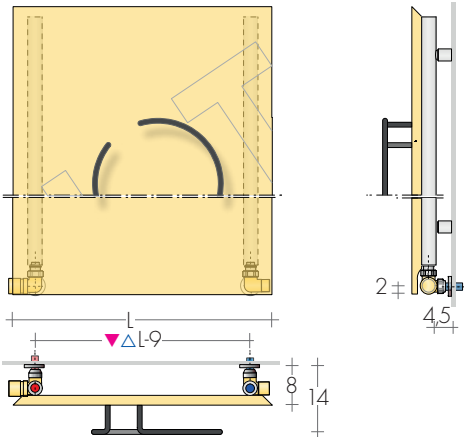

DUAL FUEL VERSION p.207

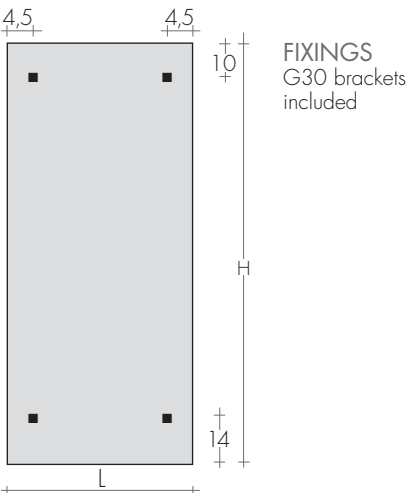
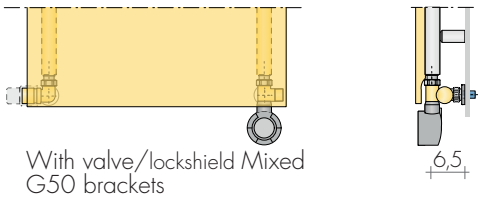

RECOMMENDED VALVES

CHROME VALVES KIT with:

- n°2 Valves with chrome tailpieces
- n°2 Fittings (multilayer ø16, copper ø12, 14)
- n°2 Chrome wall plates ø 48, hole ø16

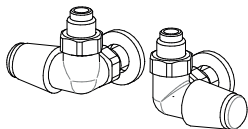

SIDE CONTROL TON VALVES KIT nickel-plated chrome-plated handwheel Art. KVLN 104,80€
SIDE CONTROL chrome TON VALVES KIT page 269 Art. KVL 130,90€

SPECIAL FINISHES

page 267
Finishes Gold, Bronze, Brushed Nickel for 2 valves

Brushed Nickel FITTING KIT extra Art. RN 30,50€

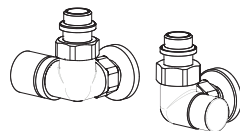

SIDE CONTROL CYL VALVES KIT with THERMOSTATIC option, page 273 Art. KCLD 162,50€
Extra for BREM color list 53,40€

BICOLOR SOLUTION:

- BIC10 Cover in a Brem color and back radiator white sablé SB9016 +10%
- BIC20 Cover in a Brem color and back radiator black sablé SB9005 or grey sablé SB7039 +20%
- BIC35 N° 2 Brem colors of your choice +35%

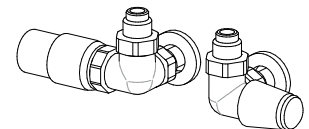

SIDE CONTROL nickel-plated ON VALVES KIT with thermostatic Head Art. KTLND 161,10€
SIDE CONTROL chrome TON VALVES KIT with thermostatic head, p.269 Art. KTLD 203,70€

LOGGIA DESIGN - TIMELESS

design Davide Diliberto

Towel warmer panel with the exclusive semicircle shape produced in the LOGGIA

DESIGN version with the towel bar in square tube of 15 mm and in the LOGGIA

TIMELESS version with flat drawn handle and shaped ends.

DIMENSIONS

Length: 54 cm

Heights: 117 / 137 / 167; Panels 167 / 197 / 217 cm

Depth: LOGGIA-D 8,1 cm LOGGIA-T 7,3 cm

Depth from wall: LOGGIA-D 11,6 cm LOGGIA-T 10,8 cm

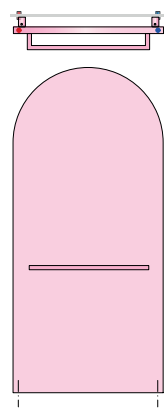

LOGGIA.. 117-54

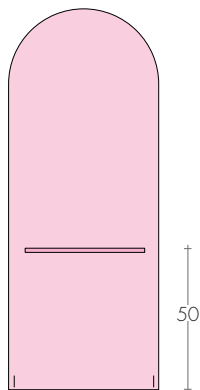

LOGGIA.. 137-54

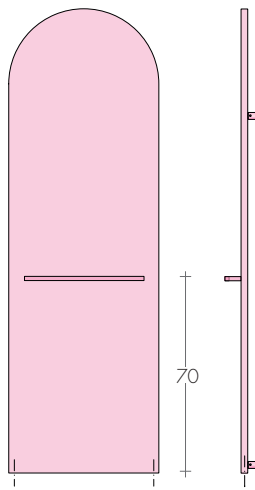

LOGGIA.. 167-54

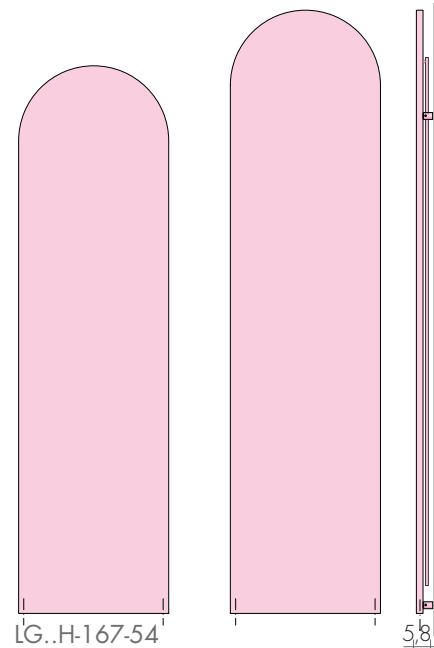

LG..H-167-54

LG..H-197-54

LG..H-217-54

Panels with the towel bar on request.



LOGGIA-D (DESIGN)



LOGGIA-T (TIMELESS)

MODEL	HL cm	Standard white sablé SB 9016 €	EN 442			▲▼ t.c. cm	Height H cm	Width L cm	Weight M Kg	Volume V dm ³	DUAL FUEL VERSION with E.H.E. and* Watt €	
			Δt 50K watt	Δt 40K watt	Δt 30K watt						Watt	€
LOGGIA-D	117-54	1112,30	641	485	337	50	117	54	19,0	6,0	650	107,80
LOGGIA-D	137-54	1189,10	758	574	398	50	137	54	22,0	7,0	800	112,60
LOGGIA-D	167-54	1295,40	933	706	490	50	167	54	27,0	8,0	900	116,20
LOGGIA-T	117-54	1132,50	641	485	337	50	117	54	19,0	6,0	650	107,80
LOGGIA-T	137-54	1209,30	758	574	398	50	137	54	22,0	7,0	800	112,60
LOGGIA-T	167-54	1315,60	933	706	490	50	167	54	27,0	8,0	900	116,20
LOGGIA PANNELS (towel bar on request)												
LGH	167-54	1234,50	933	706	490	50	167	54	27,0	8,0	900	107,50
LGLH	167-54	1444,90	1233	933	647	50	167	54	36,5	8,7	1200	115,20
LGH	197-54	1340,80	1107	838	581	50	197	54	31,7	9,4	1200	124,50
LGLH	197-54	1619,00	1476	1117	775	50	197	54	43,4	12,9	1500	135,40
LGH	217-54	1401,10	1224	927	643	50	217	54	35,0	10,4	1200	124,50
LGLH	217-54	1740,60	1638	1240	860	50	217	54	48,1	14,3	1500	135,40

Other heights LGH and LGL, on request.

*Add mixed valve p.207
Thermostats p.208-209

TOWEL BAR LOGGIA: STANDARD COLORS

- white sablé SB 9016 - quartz grey SB 7039
- black sablé SB 9005 - same color as the radiator

ADDITIONAL TOWEL BAR

Design towel bar Art. MLD 60,90€
Timeless towel bar Art. MLT 81,20€

In one paintwork to Brem color list different from the radiator extra 52,90€

STANDARD PRODUCTION

White sablé SB9016 paintwork, B15 brackets
Tolerance ± 3mm - Air vent ø 1/8"

MAXIMUM OPERATING PRESSURE 4 BAR

PRODUCTION ON REQUEST

Paintwork to BREM color list with colored brackets +15/25%
Electric version e.Loggia, page 245

STANDARD FITTING

EG ø 3/8"
Fittings 1/2" on request
Special fittings, page 278



TAPPING CENTRES

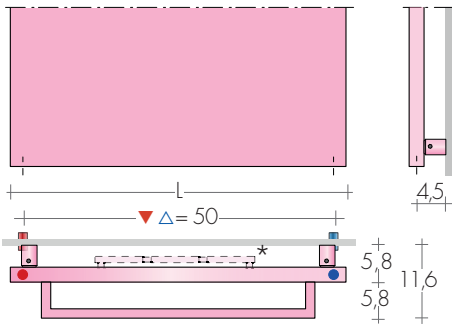

LOGGIA Design

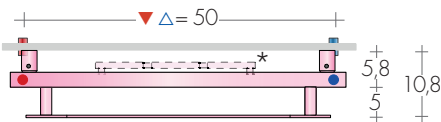

LOGGIA Timeless

*Model ..L with tubes at the rear



Fitting \varnothing 3/8"
STANDARD
(without sleeves)



Fitting \varnothing 1/2"
ON REQUEST
(with sleeves)

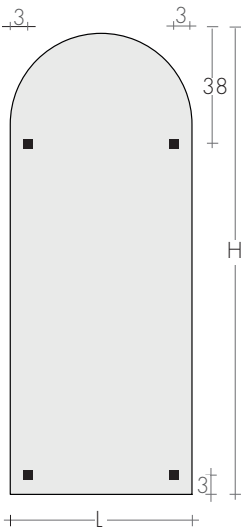

FIXINGS
Brackets included



B35 bracket



LOGGIA-D 167-54

RECOMMENDED VALVES

CHROME VALVES KIT with:

- n°2 Valves with chrome tailpieces
- n°2 Fittings (multilayer \varnothing 16, copper \varnothing 12, 14)
- n°2 Chrome wall plates \varnothing 48, hole \varnothing 16

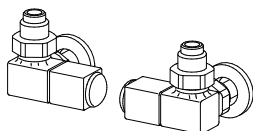

SIDE CONTROL QUADRA VALVES KIT
page 271 Art. KQL 191,20€
Extra for BREM color list 53,40€

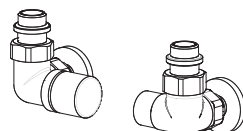

SIDE CONTROL CYL VALVES KIT with THERMO-
STATIC option, page 273 Art. KCL 162,50€
Extra for BREM color list 53,40€

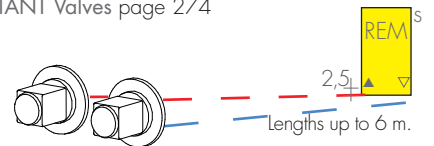

SPECIAL FINISHES page 267
Finishes Gold, Bronze, Brushed Nickel for 2 valves
Brushed Nickel FITTING KIT extra Art. RN 30,50€

REMOTE FITTINGS Art. REM 42,10€
Tapping centres: at the rear \blacktriangle \blacktriangledown EG L-5 cm
DISTANT Valves page 274

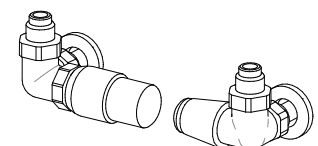

SIDE CONTROL TON VALVES KIT with THERMO-
STATIC Head, page 269 Art. KTL 203,70€

MANT

A striking heated radiator, from the essential lines with a thin panel (just 2.3 cm thick)

with a practical double towel rails open on three sides.

design Luigi Brebbia
On request, the towel rails can be painted in a BREM different colour from the plate.

DIMENSIONS

Widths: 36 / 45 / 54 cm

Heights: 80 / 130 / 180 cm

Depth: 9,5 cm

Depth: from wall 12,8 cm

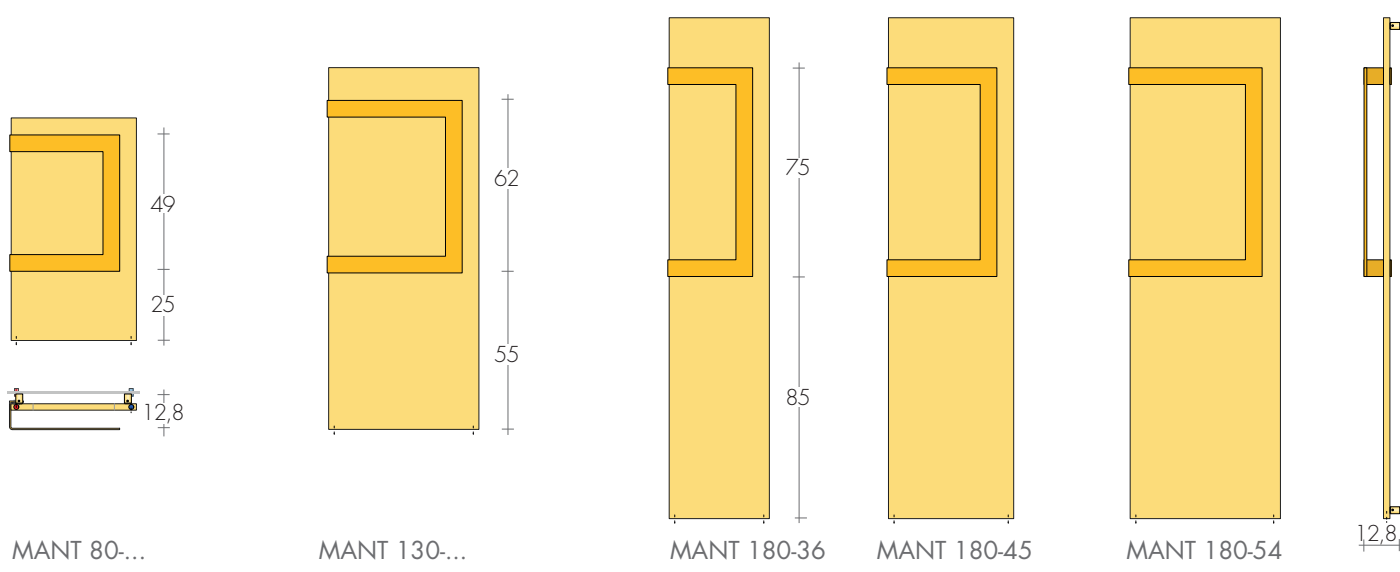

MODEL	H/L cm	Standard white sablé SB9016 €	Δt 50K watt	EN 442			▲ ▼ t.c. cm	Height H cm	Width L cm	Weight M Kg	Volume V dm ³	DUAL FUEL VERSION with E.H.E. and* Watt €	
				Δt 40K watt	Δt 30K watt								
MANT	80-45	862,70	399	302	210	41	80	45	11,3	3,8	400	103,40	
MANT	80-54	940,50	478	362	251	50	80	54	13,5	4,4	500	105,60	
MANT	130-45	1032,50	643	487	338	41	130	45	18,2	6,0	650	107,80	
MANT	130-54	1121,20	770	583	405	50	130	54	21,8	6,8	800	112,60	
MANT	180-36	1100,10	714	540	376	32	180	36	20,3	7,0	650	107,80	
MANT	180-45	1202,30	887	671	466	41	180	45	25,1	8,1	900	116,20	
MANT	180-54	1301,70	1061	803	558	50	180	54	30,0	9,2	900	116,20	
MANT-L	180-45	1450,40	1181	894	621	41	180	45	34,4	8,1	1200	124,50	

On request, free of charge, the bar on the right

*Dual fuel valve or T to be added p.207
Thermostats p.208-209

TOWEL BAR MANT: STANDARD COLORS

- white sablé SB 9016 - quartz grey SB 7039
- black sablé SB 9005 - same color as the radiator

In one paintwork to Brem color list different from the radiator
extra 52,90€

STANDARD PRODUCTION

White sablé SB9016 paintwork, B15 brackets
Tolerance \pm 3mm - Air vent \varnothing 1/8"

MAXIMUM OPERATING PRESSURE 4 BAR

PRODUCTION ON REQUEST

Paintwork to BREM color list with colored brackets
+15/25%

Electric version e.Mant, page 246

STANDARD FITTING

EG \varnothing 3/8"
Fittings \varnothing 1/2" on request
Special fittings, page 279



TAPPING CENTRES

Side fittings on request $\varnothing 3/8''$ or $\varnothing 1/2''$
 Extra Art. AS 91,20€

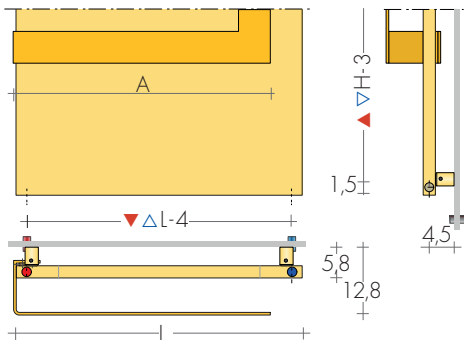

TOWEL BAR MANT WIDTH
 L36 A30,5 - L45 A39,5 - L54 A48,5 cm



Fitting $\varnothing 3/8''$
 STANDARD
 (without sleeves)



Fitting $\varnothing 1/2''$
 ON REQUEST
 (with sleeves)

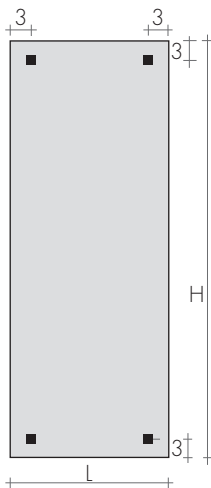

FIXINGS
 Brackets included



B35 bracket



MANT 130-54

RECOMMENDED VALVES

CHROME VALVES KIT with:

- n°2 Valves with chrome tailpieces
- n°2 Fittings (multilayer $\varnothing 16$, copper $\varnothing 12, 14$)
- n°2 Chrome wall plates $\varnothing 48$, hole $\varnothing 16$

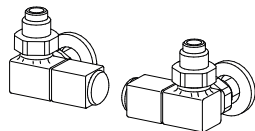

SIDE CONTROL QUADRA VALVES KIT
 page 271 Art. KQL 191,20€
 Extra for BREM color list 53,40€

SPECIAL FINISHES page 267
 Finishes Gold, Bronze, Brushed Nickel for 2 valves
 Brushed Nickel FITTING KIT extra Art. RN 30,50€

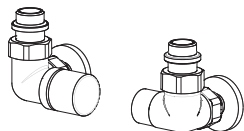

SIDE CONTROL CYL VALVES KIT with THERMO-
 STATIC option, page 273 Art. KCL 162,50€
 Extra for BREM color list 53,40€

REMOTE FITTINGS Art. REM 42,10€
 Tapping centres: at the rear $\blacktriangle \nabla$ EG L-5 cm
 DISTANT Valves page 274

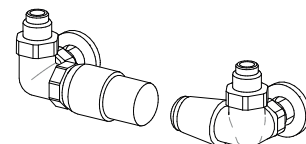
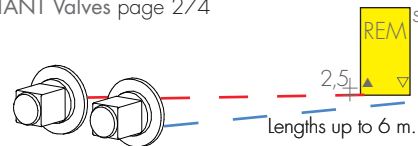

SIDE CONTROL TON VALVES KIT with THERMO-
 STATIC Head, page 269 Art. KTL 203,70€

PLATT COLOR

The essence of the radiating plate, the lightweight and the practicality of square

section chrome-plated handles, play a starring role distinguish the PLATT COLOR heated

towel rails. Can also be provided with gilded or silver leaf finish for even greater scenic effect.

DIMENSIONS

Width 52 / 53 / 59 / 63 / 66 cm
 Height 80 / 84 / 130 / 133 / 140 / 180 cm
 Depth 11,5 cm
 Depth from wall 14 cm

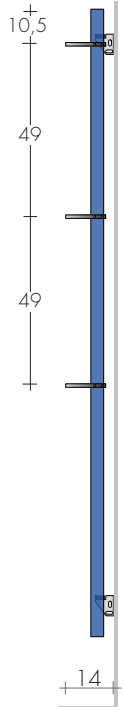
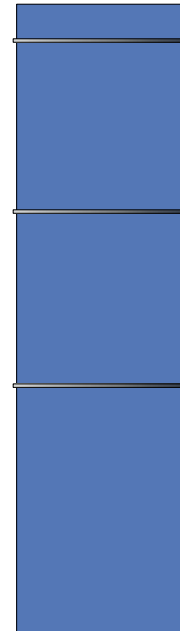
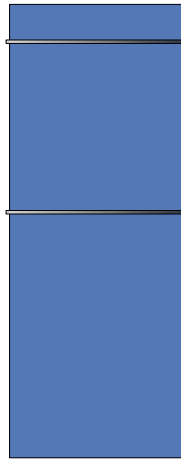
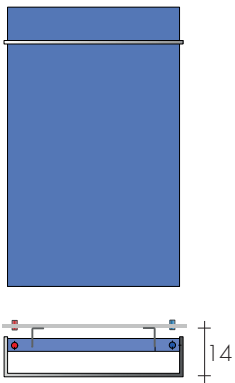

PLATT COLOR 80 - 49
 PLATT COLOR 84 - 50

PLATT COLOR 130 - ...
 PLATT COLOR 133 - 50 140-60

PLATT COLOR 180 - ...

MODEL	H/L cm	Standard white sablé SB 9016 €	Δt 50K watt	EN 442 Δt 40K watt	Δt 30K watt	▲ ▽ t.c. cm	Height H cm	Width L cm	Weight M Kg	Volume V dm³	DUAL FUEL VERSION with E.H.E. and* Watt €	
PLATT COLOR	80-49	786,50	388	290	199	45	80	52	12,1	3,4	-	-
PLATT COLOR	130-49	1030,50	610	456	314	45	130	52	18,6	5,2	-	-
PLATT COLOR	130-63	1189,10	784	586	403	59	130	66	23,8	6,8	-	-
PLATT COLOR	180-49	1262,60	817	611	420	45	180	52	25,4	7,0	-	-
PLATT COLOR	180-56	1358,00	934	699	480	52	180	59	29,1	8,0	-	-
PLATT COLOR	180-63	1453,50	1051	786	540	59	180	66	32,7	9,0	-	-
PLATT COLOR	84-50	853,40	427	319	219	46,8	84	53	12,5	3,8	400	103,40
PLATT COLOR	133-50	1154,10	645	482	331	46,8	133	53	19,9	5,9	650	107,80
PLATT COLOR	140-60	1306,90	810	606	316	56,8	140	63	25,1	7,5	800	112,60

Chrome-plated towel bar as standard for Platt Color

▶ Available in Stock

*Dual fuel valve or T to be added p.207
 Thermostats p.208-209

COLORED TOWEL BAR PLATT:

On request without supplement:

- white sablé SB 9016 - quartz grey SB 7039
- black sablé SB 9005 - same color as the radiator

In one paintwork to Brem color list different from the radiator extra 52,90€

MAXIMUM OPERATING PRESSURE 6 BAR

STANDARD PRODUCTION

White sablé SB9016 paintwork - EOS brackets
 Tolerance ± 3mm - Air vent ø1/8"

PRODUCTION ON REQUEST

Paintwork to BREM color list
 with colored brackets

+15/25%

STANDARD FITTING EG ø 1/2"

Fittings on request, page 278
 Electric version e.Platt, page 250



TAPPING CENTRES

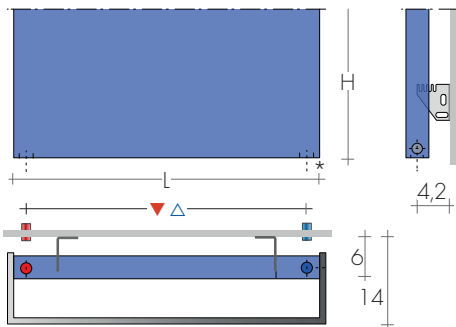

On request side fittings ▲▼ = H-3,2 cm
Extra Art. AS 91,20€

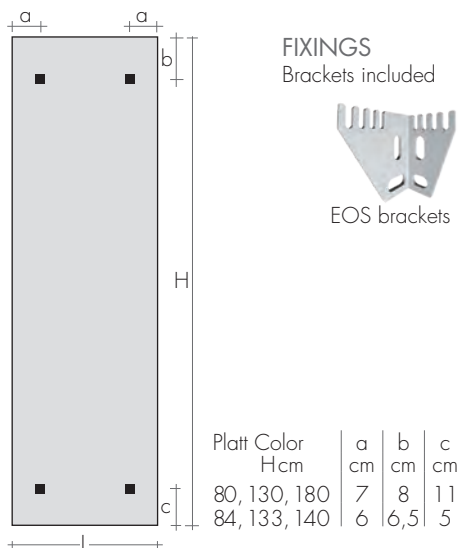

PLATT COLOR 130-49

RECOMMENDED VALVES

CHROME VALVES KIT with:

- n°2 Valves with chrome tailpieces
- n°2 Fittings (multilayer ø16, copper ø12, 14)
- n°2 Chrome wall plates ø 48, hole ø16

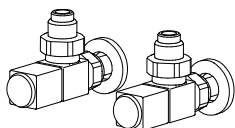

ANGLED QUADRA VALVES KIT
page 271 Art. KQS
Extra for BREM color list

180,10€
53,40€

SPECIAL FINISHES

page 267
Finishes Gold, Bronze, Brushed Nickel for 2 valves
Brushed Nickel FITTING KIT extra Art. RN 30,50€

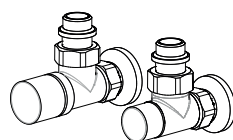

ANGLED CYL VALVES KIT with THERMOSTATIC
option, page.273 Art. KCS 149,90€
Extra for BREM color list 53,40€

REMOTE FITTINGS

Art. REM 42,10€
Tapping centres: at the rear of radiator ▲▼ EG
DISTANT Valves page 274

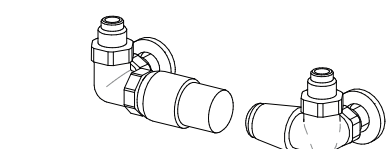
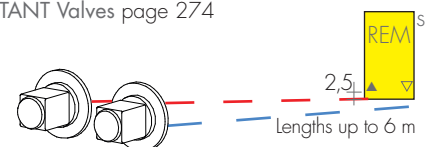

SIDE CONTROL TON VALVES KIT with THERMO-
STATIC Head, page 269 Art. KTL 203,70€

PLATT INOX

Pure high-tech enhanced by stainless steel metallic finish. This heating element in brushed stainless steel comes complete with square stainless steel handles for rarefied aesthetics. This heated towel rail offers practicality, essence, and beauty.

Stainless steel towel bar as standard for Platt Inox

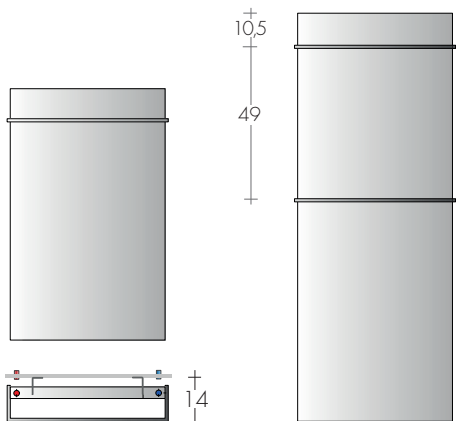

PLATT INOX 80-49
PLATT INOX 84-50

PLATT INOX 130-..
133-50 / 140-60

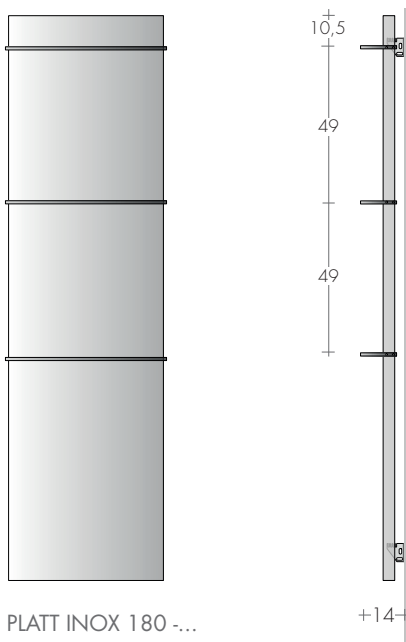

PLATT INOX 180-...



PLATT INOX 180-49

TECHNICAL DATA pag 140



VALVES BRUSHED NICKEL FINISH

Valves TON and QUADRA, and wall plates brushed nickel finish
pag 267

MODEL	HL cm	brushed # STAINLESS steel €	EN 442			▲▽ t.c. cm	DUAL FUEL VERSION with E.H.E. and*	
			Δt 50 K watt	Δt 40K watt	Δt 30 K watt		W	€
PLATT INOX 80-49	49	1163,90	388	290	199	45	-	-
PLATT INOX 130-49	49	1525,10	610	456	314	45	-	-
PLATT INOX 130-63	63	1642,40	784	586	403	59	-	-
PLATT INOX 180-49	49	1868,80	817	611	420	45	-	-
PLATT INOX 180-56	56	2010,00	934	699	480	52	-	-
PLATT INOX 180-63	63	2151,00	1051	786	540	59	-	-
PLATT INOX 84-50*	50	1247,40	427	319	219	46,8	400	103,40
PLATT INOX 133-50*	50	1635,90	645	482	331	46,8	650	107,80
PLATT INOX 140-60*	60	1734,70	810	606	316	56,8	800	112,60

#POLISCED stainless steel +20% *Dual fuel valve or T to be added p.207 - Thermostats p.208-209

PLATT GILDED/SILVER LEAF

Light aesthetics in minimalist form, intense colours never of marginal importance in the room.
And more! PLATT heated towel rails can also be provided with gilded (FO) or (FA) silver leaf finish on request for even greater scenic effect.

Towel bar in BRO019 color for gilded leaf, in BRO002 color for silver leaf as standard.
Gilded/silver leaf towel bar extra (each) 150,90€

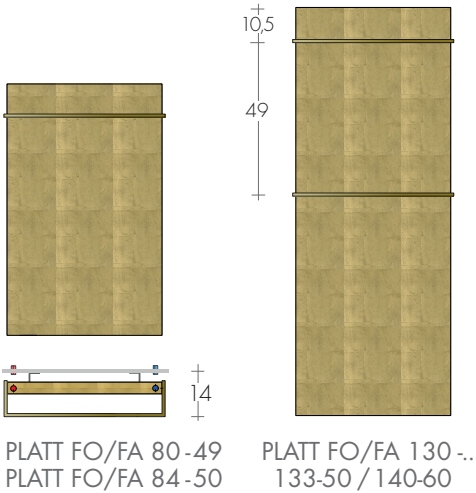

PLATT FO/FA 80-49
PLATT FO/FA 84-50
PLATT FO/FA 130-50
PLATT FO/FA 140-60

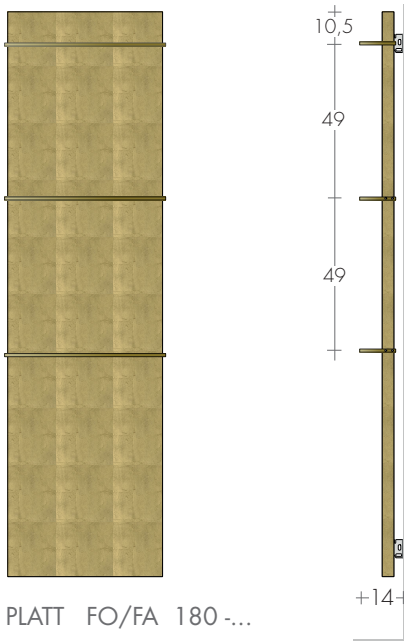

PLATT FO/FA 180-...

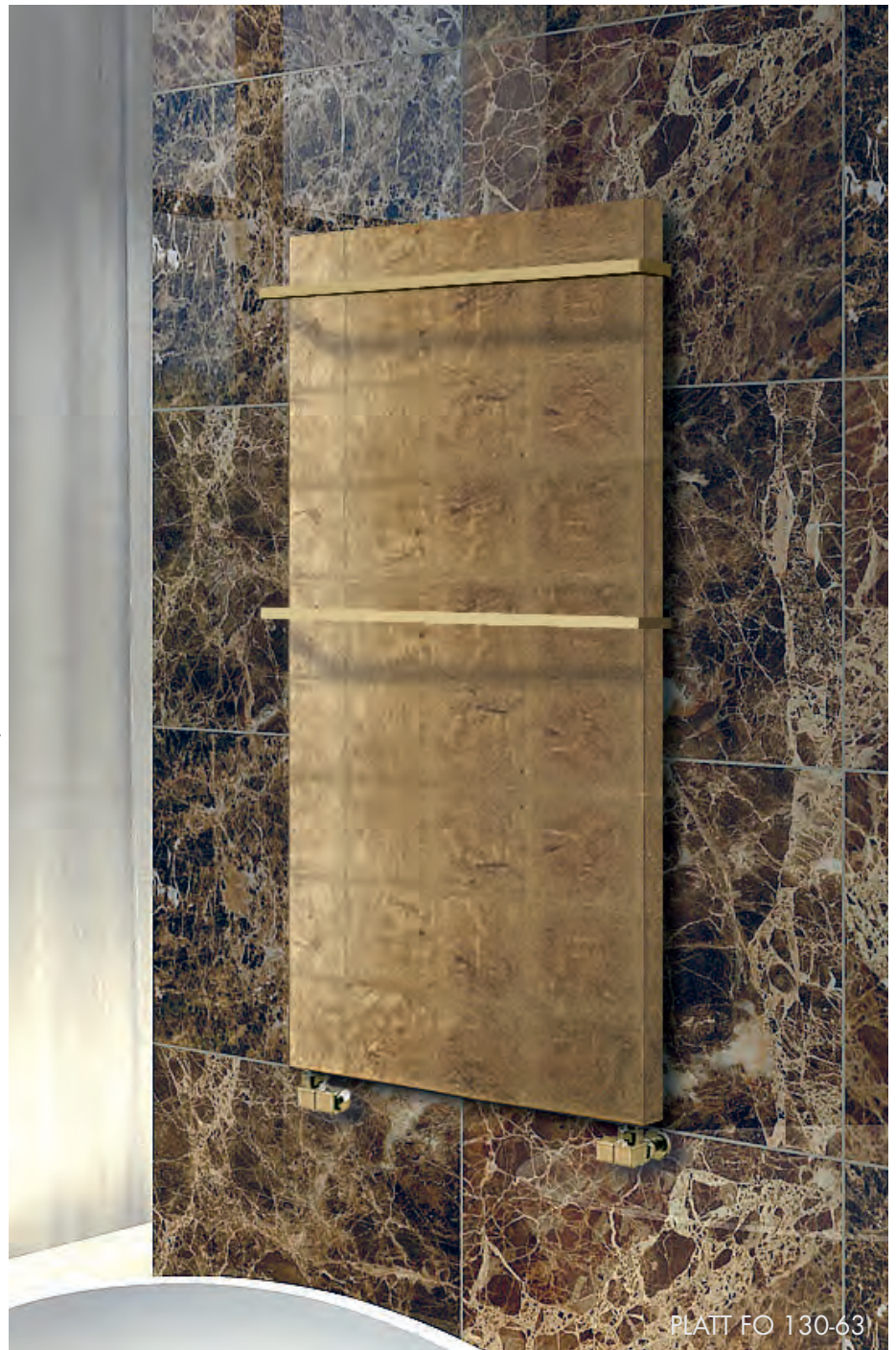

PLATT FO 130-63



PLATT FO



PLATT FA

TECHNICAL DATA pag 140



SPECIAL FINISHEES VALVES

TON and QUADRA valve in golden finish, gilded leaf and silver leaf. pag 267

MODEL	HL cm	VERSIONS Leaf Gilded / Silver €	EN 442			▲ ▽ t.c. cm	DUAL FUEL VERSION with E.H.E. and* W €	
			Δt 50K watt	Δt 40K watt	Δt 30K watt		W	€
PLATT FO/FA 80-49	80-49	1545,70	388	290	199	45	-	-
PLATT FO/FA 130-49	130-49	1991,80	610	456	314	45	-	-
PLATT FO/FA 130-63	130-63	2230,10	784	586	403	59	-	-
PLATT FO/FA 180-49	180-49	2527,90	817	611	420	45	-	-
PLATT FO/FA 180-56	180-56	2675,50	934	699	480	52	-	-
PLATT FO/FA 180-63	180-63	2822,70	1051	786	540	59	-	-
PLATT FO/FA 84-50*	84-50*	1613,00	427	319	219	46,8	400	103,40
PLATT FO/FA 133-50*	133-50*	2130,70	645	482	331	46,8	650	107,80
PLATT FO/FA 140-60*	140-60*	2417,80	810	606	316	56,8	800	112,60

*Dual fuel valve or T to be added p.207 - Thermostats p.208-209

UNI-PLATT

design Francesca Mocchi

The simplicity of UNI-PLATT plate, in one color from Brem colors list, the usefull upper

handle complete with hooks for bathrobes, painted in the same color of the towel rail.

On request, the handles are painted in a color different from the plate or chrome-plated

DIMENSIONS

Width 50,5 / 51,5 / 57,5 / 61,5 cm
Height 77 / 80 / 126 / 130 / 140 / 180 cm
Depth 11 cm
Depth from wall 14 cm

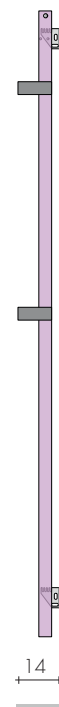
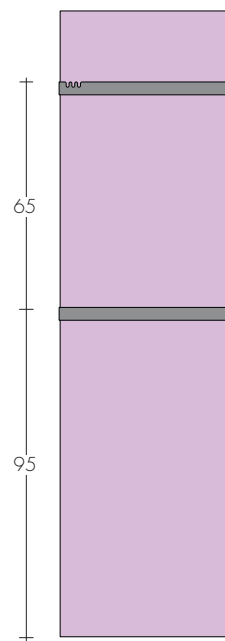
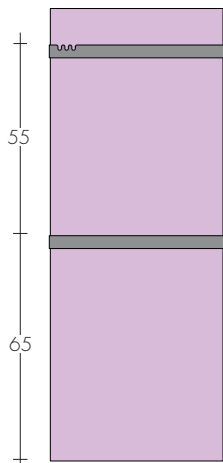
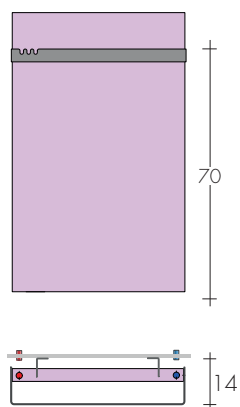

UNI-PLATT 80-49
UNI-PLATT 77-50

UNI-PLATT 126-50/130-...
UNI-PLATT 140-60

UNI-PLATT 180-...

MODEL	HL cm	Standard white sablé SB 9016 €	EN 442			▲▼ t.c. cm	Height H cm	Width L cm	Weight M Kg	Volume V dm ³	DUAL FUEL VERSION with E.H.E. and*	
			Δt 50K watt	Δt 40K watt	Δt 30K watt						Watt	€
UNI-PLATT	80-49	713,90	388	290	199	45	80	50,5	12,1	3,4	-	-
UNI-PLATT	130-49	940,60	610	456	314	45	130	50,5	18,6	5,2	-	-
UNI-PLATT	130-56	1013,60	697	521	358	52	130	57,5	21,3	5,9	-	-
UNI-PLATT	180-49	1137,90	817	611	420	45	180	50,5	25,4	7,0	-	-
UNI-PLATT	180-56	1225,60	934	699	480	52	180	57,5	29,1	8,0	-	-
UNI-PLATT	77-50	745,00	395	295	208	46,8	77	51,5	11,5	3,4	400	103,40
UNI-PLATT	126-50	1021,30	614	459	323	46,8	126	51,5	18,9	5,6	650	107,80
UNI-PLATT	140-60	1176,70	810	606	416	56,8	140	61,5	25,1	6,7	800	112,60

► Available in Stock

*Dual fuel valve or T to be added p.207
Thermostats p.208-209



Standard towel bar UNI: - standard white SB9016
- grey sablé SB 7039 - sablé black SB9005
- same color ordered with the radiator



Additional towel bar UNI white (each) 74,40€
Towel bar UNI in different Brem colour from plate
extra (each) 52,90€

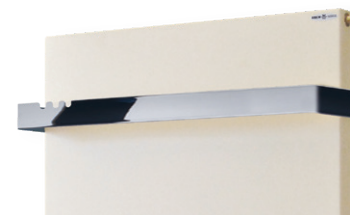

Chrome-plated towel bar extra (each) 88,30€
Additional Chrome-plated towel bar (each) 162,70€

STANDARD PRODUCTION

White sablé SB9016 paintwork - Air vent ø1/8"
MAXIMUM OPERATING PRESSURE 6 BAR

PRODUCTION ON REQUEST

Paint to Brem color list with colored
brackets +15/25%

STANDARD FITTING

EG ø1/2"
Electric version e.Uni-Platt p. 260



TAPPING CENTRES

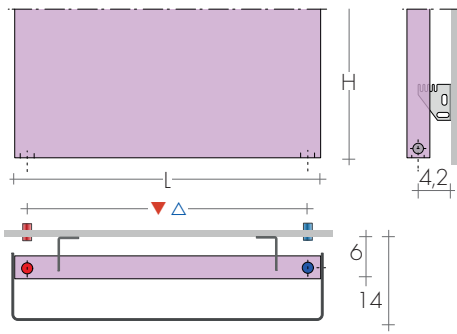

On request side fittings ▲▼ = H-3,2 cm
Extra Art. AS 91,20€

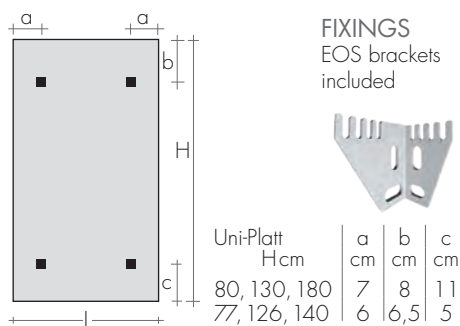

FIXINGS
EOS brackets
included



UNI-PLATT 130-49

RECOMMENDED VALVES

CHROME VALVES KIT with:

- n°2 Valves with chrome tailpieces
- n°2 Fittings (multilayer ø16, copper ø12, 14)
- n°2 Chrome wall plates ø 48, hole ø16

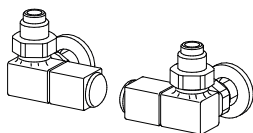

SIDE CONTROL QUADRA VALVES KIT
page 271 Art. KQL 191,20€
Extra for BREM color list 53,40€

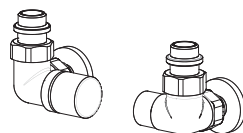

SIDE CONTROL CYL VALVES KIT with THERMO-
STATIC option, page 273 Art. KCL 162,50€
Extra for BREM color list 53,40€

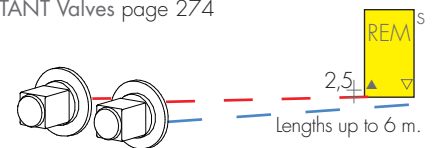

SPECIAL FINISHES page 267
Finishes Gold, Bronze, Brushed Nickel for 2 valves
Brushed Nickel FITTING KIT extra Art. RN 30,50€

REMOTE FITTINGS Art. REM 42,10€
Tapping centres: at the rear of radiator ▲▼ EG
DISTANT Valves page 274

SIDE CONTROL TON VALVES KIT with THERMO-
STATIC Head, page 269 Art. KTL 203,70€

VELETTA

design Davide Diliberto

VELETTA for Brem was designed to hide bathrobes and towels without the use of sliding walls or doors.

The radiating plate is split in half by a fold that creates a separate wing from the wall for a practical, simple solution.

Two magnetic knobs on the back let you hang bathrobes wherever desired.

DIMENSIONS

Widths: 42 / 50 cm

Heights: 135 / 175 cm

Depths: 15 / 19 / 21 cm

Depths from wall: 18,5 / 22,5 cm

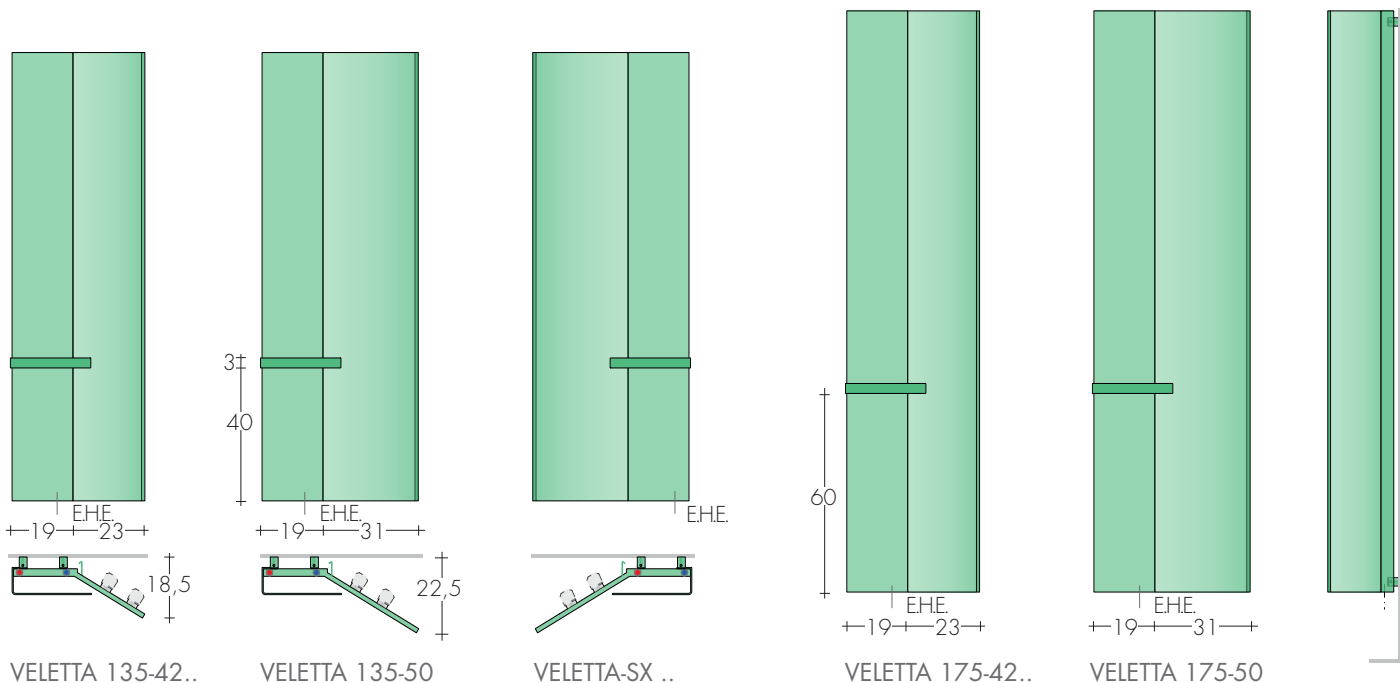

VELETTA 135-42..

VELETTA 135-50

VELETTA-SX ..

VELETTA 175-42..

VELETTA 175-50

MODEL	HL cm	Standard white sablé SB9016 €	Δt 50K watt	EN 442		Δt 30K watt	Δ ∇ t.c. cm	Height H cm	Width L cm	Weight M Kg	Volume V dm ³	DUAL FUEL VERSION with E.H.E. and sleeve	
				Δt 40K watt	Δt 30K watt							Watt	€
VELETTA	135-42	1145,80	669	506	352	15	135	42	19,7	5,8	650	131,80	
VELETTA	135-50	1234,40	800	606	421	15	135	50	23,2	6,6	800	136,60	
VELETTA	175-42	1212,80	865	655	455	15	175	42	25,2	7,5	900	140,20	
VELETTA	175-50	1307,30	1033	782	543	15	175	50	29,7	8,5	900	140,20	
VELETTA-L	175-50	1571,60	1191	902	627	15	175	50	35,7	10,3	1200	148,50	

VERSION-SX, on request without extra

Thermostats p.228-229

TOWEL BAR VEL: STANDARD COLORS

- white sablé SB 9016
- quartz grey SB 7039
- black sablé SB 9005
- same color as the radiator

In one paintwork to Brem color list different from the radiator
extra 52,90€

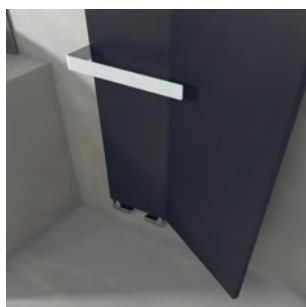

MAGNETIC KNOBS
NOT INCLUDED
page 277

Art. ARC / POC / HKC
each 95,50€



STANDARD PRODUCTION

White sablé SB9016 paintwork, B35 brackets
Tolerance \pm 3mm - Air vent \varnothing 1/8"
MAXIMUM OPERATING PRESSURE 4 BAR

PRODUCTION ON REQUEST

Paintwork to BREM color list
with colored brackets
Electric version e.VelettA

+15/25%
page 261

STANDARD FITTING

EG \varnothing 3/8"
1/2" fittings on request
Special fittings, page 278

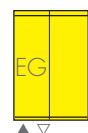

TAPPING CENTRES

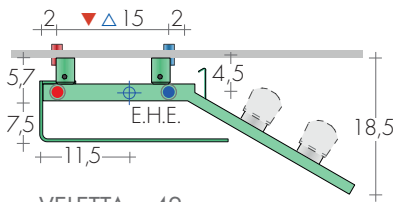

VELETTA ...-42

Knobs on demand

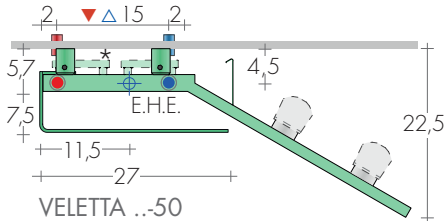

VELETTA ...-50

*Model ...L with tubes at the rear
MIXED versions with R.E. sleeve, use angle valves.



Fitting \varnothing 3/8"
STANDARD
(without sleeves)



Fitting \varnothing 1/2"
ON REQUEST
(with sleeves)

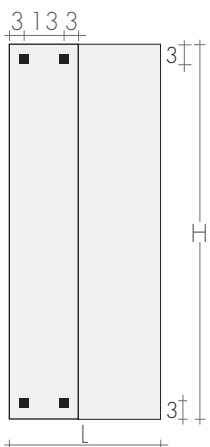

FIXINGS
Brackets included



B35 bracket



VELETTA 175-50

RECOMMENDED VALVES

CHROME VALVES KIT with:

- n°2 Valves with chrome tailpieces
- n°2 Fittings (multilayer \varnothing 16, copper \varnothing 12, 14)
- n°2 Chrome wall plates \varnothing 48, hole \varnothing 16

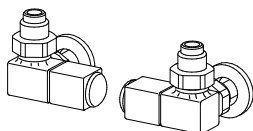

SIDE CONTROL QUADRA VALVES KIT
page 271 Art. KQL 191,20€
Extra for BREM color list 53,40€

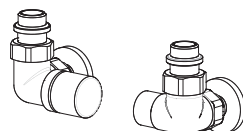

SIDE CONTROL CYL VALVES KIT with THERMO-
STATIC option, page 273 Art. KCL 162,50€
Extra for BREM color list 53,40€

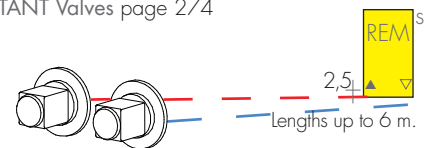

SPECIAL FINISHES page 267
Finishes Gold, Bronze, Brushed Nickel for 2 valves
Brushed Nickel FITTING KIT extra Art. RN 30,50€

REMOTE FITTINGS Art. REM 42,10€
Tapping centres: at the rear of radiator \blacktriangle \blacktriangledown 15 cm
DISTANT Valves page 274

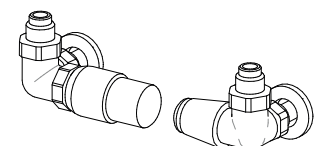

SIDE CONTROL TON VALVES KIT with THERMO-
STATIC Head, page 269 Art. KTL 203,70€

INDEX TubesDESIGN

RADIATORS WITH TUBES

RADIATORS COLLECTION

	page
CHEM	150
FORM	152
GRATA	156
RING	160
WIND	164

TOWEL-HEATER COLLECTION

	page
CANNUCCIA	168
CHEM-M	170
CHEM-S	172
FRAC	174
KUAD	176
MAHN	178
MAHN-AIR	180
PLANK	182
PLANK-AIR	184
PLUS 12	186
PLUS 18	188
PLUS-AIR	190
RAW	192
SHAR	196
SHAR-AIR	198
START	200
DIVIS	202



CHEM

design Davide Diliberto

CHEM is a radiator comprising round tube elements, \varnothing 9 cm, with the final section curving

towards the wall. It is produced in different heights, either as a single unit or as a modular

unit with up to 7 elements. It can be supplemented with the element at its curvst height 96 cm

DIMENSIONS

Width: da 9 a 93cm
 Height: 96 /196 /216 /236 /256 cm
 Depth: 18 cm
 Depth from wall: 18 cm

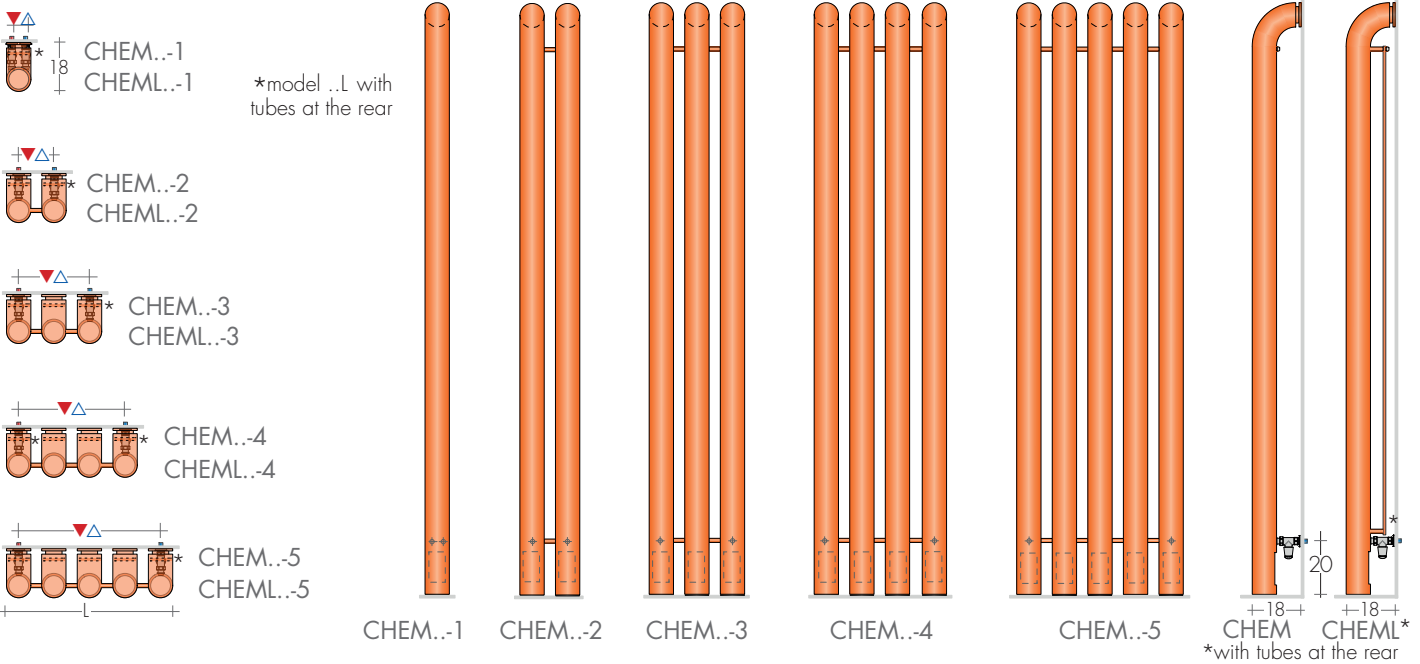

MODEL	H cm	n°el. L cm ▲▽ cm	1el	2 el	3 el	4 el	5 el	6 el	7 el
			9 5	23 14	37 28	51 42	65 56	79 70	93 84
CHEM 196 €			682,10 326w	917,30 655w	1152,50 984w	1405,40 1313w	1658,20 1642w		
CHEML 196 €			787,90 493w	1129,00 989w	1470,00 1485w	1828,70 1981w	2187,40 2477w		
CHEM 216 €			717,40 367w	970,30 737w	1223,00 1107w	1493,50 1477w	1764,00 1847w		
CHEML 216 €			827,90 555w	1191,30 1113w	1554,70 1671w	1935,70 2229w	2316,70 2787w		
CHEM 236 €			752,60 408w	1023,10 819w	1293,60 1230w	1581,80 1641w	1869,80 2052w		
CHEML 236 €			867,90 617w	1253,60 1237w	1639,30 1857w	2042,80 2477w	2446,10 3097w		
CHEM 256 €			787,90 449w	1076,10 901w	1364,20 1353w	1669,90 1805w	1975,70 2257w		
CHEML 256 €			907,90 679w	1316,00 1361w	1724,00 2043w	2149,70 2725w	2575,40 3407w		
CHEM 96 €			341,00 138w	458,60 279w	576,20 420w	699,80 561w	823,20 702w	946,70 843w	1070,20 984w
CHEML 96 €			415,20 217w	624,50 437w	833,80 657w	1043,20 877w	1252,50 1097w	1461,80 1317w	1671,20 1537w

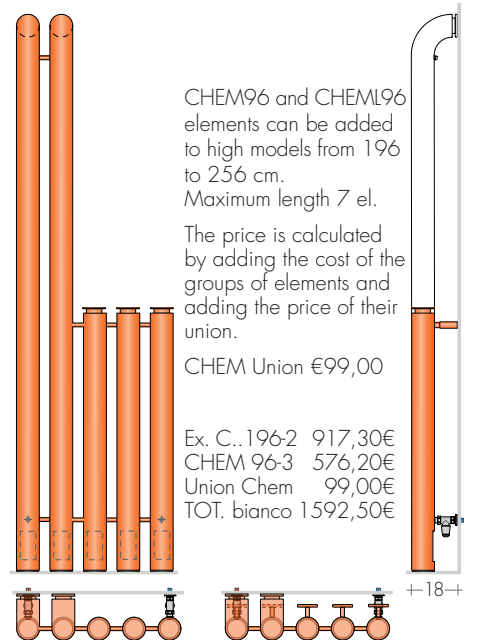

Heights on request.

Tolerance \pm 3mm
 Air vent \varnothing 1/8"

STANDARD PRODUCTION

White sablé SB9016 paintwork, brackets white
 Maximum operating pressure: CHEM 8 BAR
 CHEM with tubes at the rear: CHEML 4 BAR

PRODUCTION ON REQUEST

Paintwork to Brem color list (with colored brackets) +15/25%
 Electric version e.Chem p.214

STANDARD FITTING EG \varnothing 1/2", on the back of the tube with straight valves. Side connections with angle valves on request.



TAPPING CENTRES

CHEM ..1 el. CHEM.. - from 2 to 4 elements

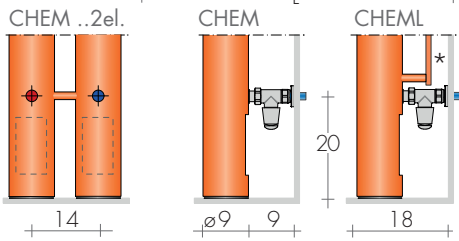
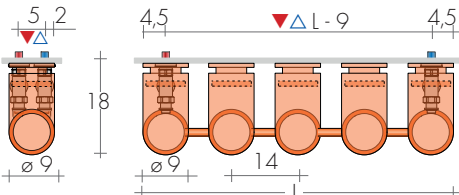

*with tubes at the rear

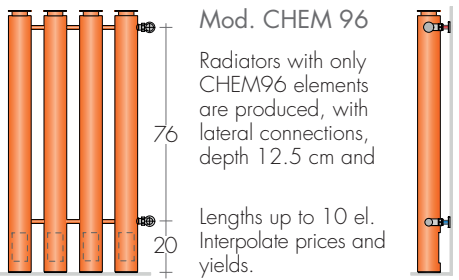

Mod. CHEM 96

Radiators with only CHEM96 elements are produced, with lateral connections, depth 12.5 cm and

Lengths up to 10 el. Interpolate prices and yields.

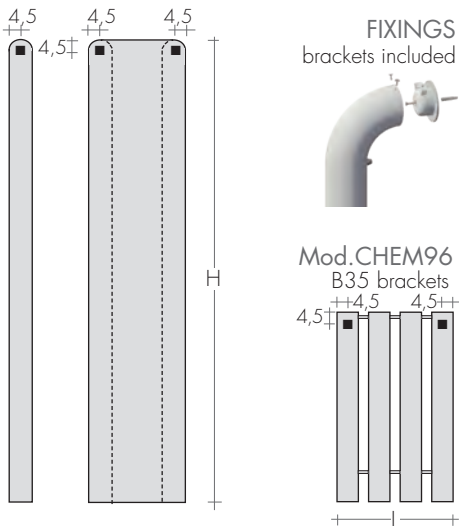
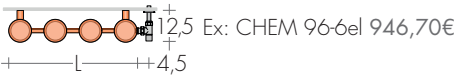

FIXINGS brackets included

Mod. CHEM96 B35 brackets



CHEM 216-3

RECOMMENDED VALVES

CHROME VALVES KIT with:

- n°2 Valves with tailpieces
- n°2 Fittings (multilayer ø 16, copper ø 12, 14)
- n°2 Chrome wall plates ø 48, hole ø 16

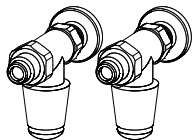

KIT STRAIGHT VALVES TON

page 269

Art. KVD 149,30€

STRAIGHT MINI VALVES KIT

chrome-plated, page 270

Art. KMD 136,90€

SPECIAL FINISHES

page 267

Finishes Gold, Bronze, Brushed Nickel for 2 valves

Brushed Nickel FITTING KIT extra Art. RN 30,50€

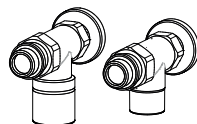

KIT STRAIGHT VALVES CYL with THERMOSTATIC

option, page.273

Art. KCD 158,80€

Extra for BREM color list

53,40€

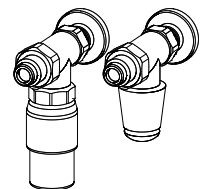

KIT STRAIGHT VALVES TON with THERMOSTATIC

Head, page 273

Art. KTD 202,40€

FORM

design Luigi Brembilla

The design of the FORM radiator pays a lot of attention not only on the shape of the

manifolds and the extremely reduced sizes of the radiating tubes, but also on the high

technology applied in its construction which allows an impeccable finish.

MODEL F...H

with vertical radiating tubes

H = from 60 to 300 cm (every 20 cm)

L = from 20 to 116 cm (every 6 cm)

Metal reinforced on radiator backs for heights greater than 80 cm.

F2H

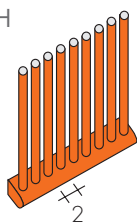

1 tube every 2 cm

F3H

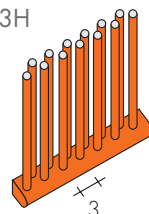

2 tubes every 3 cm

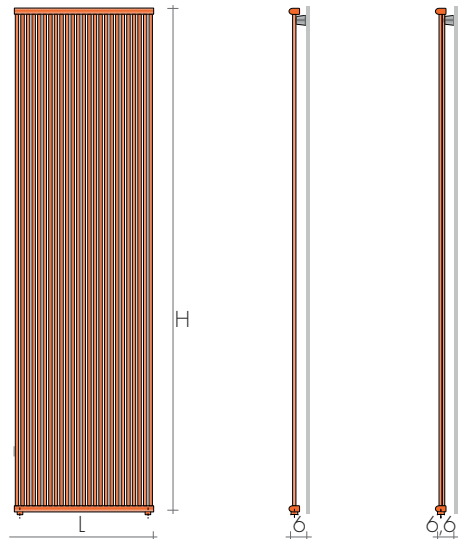

MODEL F...V

with horizontal radiating tubes

H = from 20 to 116 cm (every 6 cm)

L = from 60 to 300 cm (every 20 cm)

Metal reinforced on radiator backs for lengths greater than 80 cm.

F2V

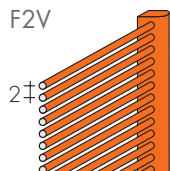

1 tube every 2 cm

F3V

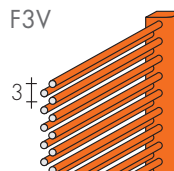

2 tubes every 3 cm

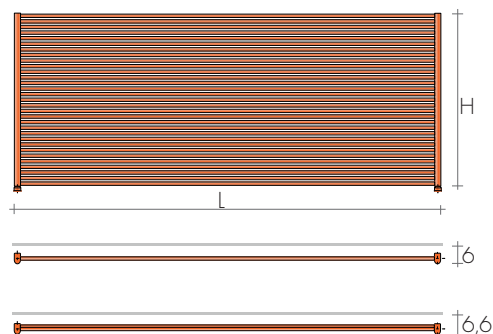

FORM F2V 62-280

STANDARD PRODUCTION

SB9016 white sablé paintwork, M4 brackets

Air vent \varnothing 1/8" - Tolerance \pm 3 mm

MAXIMUM OPERATING PRESSURE, 8 BAR

152

PRODUCTION ON REQUEST

Paintwork to Brem color list with

chrome-plated M4 brackets

Made-to-measure, by estimate

+15/25%

STANDARD FITTINGS

EG \varnothing 1/2", on request 3/8"

Fittings AC or BD on request

Special fittings, page 278

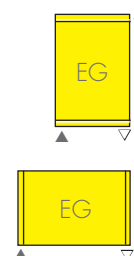

TAPPING CENTRES

EG vertical standard fittings, side fittings on request without extra

MODEL FH

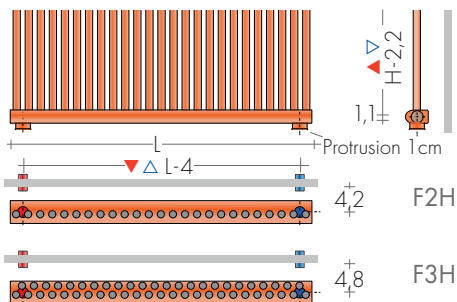

MODEL FV

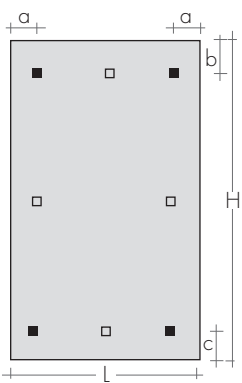
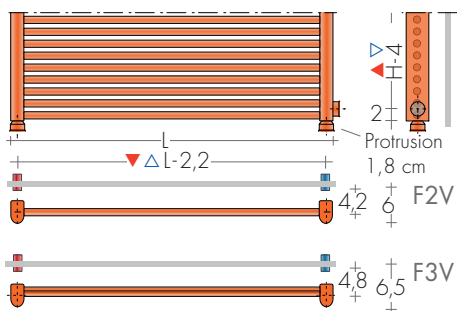

FIXINGS
Brackets included



Mod.	a cm	b cm	c cm
FH	4	3,5	3,5
FV	3,5	4	4

□ from H or L 210 cm



RECOMMENDED VALVES

CHROME VALVES KIT with:

- n°2 Valves with tailpieces
- n°2 Fittings (multilayer ø 16, copper ø 12, 14)
- n°2 Chrome wall plates ø 48, hole ø 16

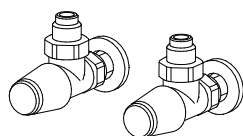

KIT ANGLED VALVES TON
page 269

Art. KVS 137,10€

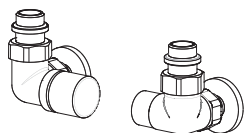

KIT SIDE control VALVES CYL with THERMOSTATIC
option, page 273 Art. KCL 162,50€
Extra for BREM color list 53,40€



SPECIAL FINISHES page 267
Finishes Gold, Bronze, Brushed Nickel for 2 valves
Brushed Nickel FITTING KIT extra Art. RN 30,50€

REMOTE FITTINGS Art. REM 42,10€
Tapping centres: at the rear of radiator ▲▼ EG
DISTANT Valves page 274

KIT SIDE control VALVES TON with Thermostatic
Head, page 269 Art. KTL 203,70€

FORM F2H

MOD.	L cm	EN 442 Watt Δt 50K (Δt 40K = $W \times 0,755$) - (Δt 30K = $W \times 0,526$)													
		20	26	32	38	44	50	56	62	68	74	80	86	92	98
H cm (n° t)		(10t)	(13t)	(16t)	(19t)	(22t)	(25t)	(28t)	(31t)	(34t)	(37t)	(40t)	(43t)	(46t)	(49t)
▲▼ cm		16	22	28	34	40	46	52	58	64	70	76	82	88	94
F2H 60 €	286,40 158w	324,70 206w	354,70 254w	383,00 302w	412,30 349w	447,30 397w	501,80 445w	559,90 492w	589,60 540w	613,30 588w	656,00 635w	695,70 683w	743,50 730w	788,00 778w	
F2H 80 €	305,00 213w	342,40 276w	374,60 340w	406,70 404w	434,90 468w	472,10 532w	526,30 595w	590,60 659w	648,40 723w	707,80 787w	753,60 850w	800,40 914w	837,40 978w	877,10 1042w	
F2H 100 €	312,60 266w	354,70 345w	386,60 425w	419,00 505w	449,80 584w	487,80 664w	548,40 744w	610,40 823w	668,30 903w	730,40 983w	793,30 1062w	852,30 1142w	911,80 1222w	973,70 1301w	
F2H 120 €	333,50 317w	378,10 412w	411,50 508w	446,20 603w	477,10 698w	518,30 793w	582,30 888w	645,80 983w	711,60 1078w	775,90 1174w	840,10 1269w	905,90 1364w	968,60 1459w	1035,10 1554w	
F2H 140 €	358,50 368w	406,70 478w	443,40 588w	477,10 698w	515,30 809w	554,70 919w	623,70 1029w	694,30 1140w	762,20 1250w	833,10 1360w	903,10 1470w	971,20 1581w	1041,30 1691w	1111,60 1801w	
F2H 160 €	404,10 417w	455,80 542w	496,50 667w	537,70 792w	576,90 917w	623,70 1042w	701,90 1166w	779,50 1291w	856,50 1416w	932,80 1541w	1012,80 1666w	1092,10 1791w	1168,70 1916w	1247,60 2041w	
F2H 180 €	446,20 464w	502,50 603w	547,30 742w	593,20 882w	640,10 1021w	691,50 1160w	776,80 1299w	863,60 1438w	950,20 1578w	1036,70 1717w	1122,10 1856w	1209,40 1995w	1296,20 2134w	1381,20 2274w	
F2H 190 €	467,40 486w	527,20 632w	574,30 778w	621,70 923w	668,30 1069w	725,10 1215w	813,00 1361w	905,90 1507w	994,60 1652w	1085,20 1798w	1177,30 1944w	1266,40 2090w	1355,10 2236w	1447,00 2381w	
F2H 200 €	487,80 510w	549,70 663w	600,50 816w	650,00 969w	698,40 1122w	757,20 1275w	851,00 1427w	945,40 1580w	1039,50 1733w	1133,90 1886w	1229,50 2039w	1324,30 2192w	1418,40 2345w	1509,60 2498w	
F2H 210 €	506,90 532w	573,30 692w	623,70 852w	678,00 1012w	727,80 1171w	788,00 1331w	885,70 1491w	985,70 1650w	1082,60 1810w	1181,20 1970w	1278,50 2130w	1377,60 2289w	1474,90 2449w	1572,90 2609w	
F2H 220 €	526,30 554w	597,10 720w	648,40 887w	703,20 1053w	756,60 1219w	818,90 1386w	921,60 1552w	1023,10 1718w	1122,10 1884w	1226,70 2051w	1329,40 2217w	1430,70 2383w	1534,20 2549w	1635,60 2716w	
F2H 240 €	567,10 597w	641,20 776w	696,90 955w	754,80 1134w	811,80 1313w	879,80 1493w	988,60 1672w	1095,70 1851w	1204,70 2030w	1314,50 2209w	1425,40 2388w	1534,20 2567w	1644,70 2746w	1754,50 2925w	
F2H 260 €	620,10 638w	701,90 830w	763,70 1021w	827,60 1213w	889,50 1404w	963,80 1596w	1080,80 1788w	1199,60 1979w	1319,40 2171w	1469,00 2362w	1561,50 2554w	1681,20 2745w	1800,10 2937w	1919,80 3128w	
F2H 280 €	674,70 678w	762,20 881w	831,30 1085w	899,40 1288w	967,30 1492w	1046,60 1695w	1178,40 1898w	1305,60 2102w	1436,30 2305w	1598,50 2509w	1701,40 2712w	1832,10 2915w	1960,40 3119w	2090,30 3322w	
F2H 300 €	732,80 716w	830,40 931w	904,40 1146w	977,10 1361w	1051,6 1576w	1138,90 1791w	1280,20 2005w	1421,80 2220w	1564,10 2435w	1738,40 2650w	1849,50 2865w	1992,80 3080w	2133,30 3295w	2275,60 3509w	

Δt different from 50 K: consult Technical data Brem

HOW TO ORDER State: model, height and width in cm; fitting and color if different from standard.

Mod. Form pitch 2 cm horizontal manifold height cm length cm

F2H 200 - 50

eg. : F2H 200-50, AC \varnothing 3/8", RAL 3003

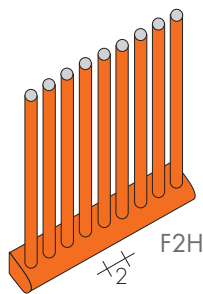

FORM ONDULATO

MOD.	L cm	EN 442 Watt Δt 50K (Δt 40K = $W \times 0,755$) - (Δt 30K = $W \times 0,526$)									
		32	38	44	50	56	62	68	74	80	
H cm (n° pipes)		(16t)	(19t)	(22t)	(25t)	(28t)	(31t)	(34t)	(37t)	(40t)	
▲▼ cm		28	34	40	46	52	58	64	70	76	

FO 180 €	864,80 742w	909,20 882w	966,20 1021w	1016,70 1160w	1113,30 1299w	1195,60 1438w	1291,40 1578w	1375,80 1717w	1472,10 1856w
FO 190 €	904,50 778w	950,10 923w	994,40 1069w	1062,30 1215w	1147,20 1361w	1249,00 1507w	1336,20 1652w	1435,10 1798w	1525,10 1944w
FO 200 €	941,40 816w	977,10 969w	1036,60 1122w	1093,00 1275w	1196,60 1427w	1288,20 1580w	1391,90 1733w	1481,90 1886w	1575,40 2039w
FO 210 €	964,80 852w	1016,70 1012w	1064,60 1171w	1136,20 1331w	1231,30 1491w	1339,90 1650w	1432,50 1810w	1527,50 1970w	1623,80 2130w
FO 220 €	988,40 887w	1041,20 1053w	1105,60 1219w	1165,90 1386w	1276,90 1552w	1375,80 1718w	1472,10 1884w	1573,40 2051w	1671,80 2217w

FORM ONDULATO (wavy) is made-to-measure, attach drawing with measurements for estimate.

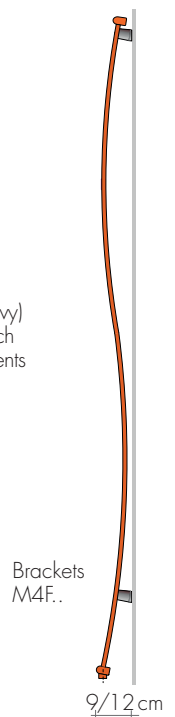

FORM F2V

EN 442 Watt Δt 50K (Δt 40K = $W \times 0,755$) - (Δt 30K = $W \times 0,526$)

MOD. (n° t.)	L cm ▲ ▼	Lengths/Longueurs												
		60	80	100	120	140	160	180	200	220	240	260	280	300
F2V 20 (10t)	€	286,40 156w	305,00 208w	312,60 260w	333,50 312w	358,50 364w	404,10 416w	446,20 468w	487,80 520w	526,30 572w	567,10 624w	620,10 676w	674,70 728w	732,80 780w
F2V 26 (13t)	€	324,70 203w	342,40 270w	354,70 338w	378,10 406w	406,70 473w	455,80 541w	502,50 608w	549,70 676w	597,10 744w	641,20 811w	701,90 879w	762,20 946w	830,40 1014w
F2V 32 (16t)	€	354,70 250w	374,60 334w	386,60 417w	411,50 500w	443,40 584w	496,50 667w	547,30 751w	600,50 834w	648,40 917w	696,90 1001w	763,70 1084w	831,30 1168w	904,40 1251w
F2V 38 (19t)	€	383,00 298w	406,70 397w	419,00 496w	446,20 595w	477,10 694w	537,70 794w	593,20 893w	650,00 992w	703,20 1091w	754,80 1190w	827,60 1290w	899,40 1389w	977,10 1488w
F2V 44 (22t)	€	412,30 344w	434,90 459w	449,80 574w	477,10 689w	515,30 804w	576,90 918w	640,10 1033w	698,40 1148w	756,60 1263w	811,80 1378w	889,50 1492w	967,30 1607w	1051,60 1722w
F2V 50 (25t)	€	447,30 397w	472,10 529w	487,80 661w	518,30 793w	554,70 925w	623,70 1058w	691,50 1190w	757,20 1322w	818,90 1454w	879,80 1586w	963,80 1719w	1046,60 1851w	1138,90 1983w
F2V 56 (28t)	€	489,00 445w	500,80 593w	548,40 741w	582,30 889w	623,70 1037w	701,90 1186w	776,80 1334w	851,00 1482w	921,60 1630w	988,60 1778w	1080,80 1927w	1178,40 2075w	1280,20 2223w
F2V 62 (31t)	€	559,90 494w	590,60 658w	610,40 823w	645,80 988w	694,30 1152w	779,50 1317w	863,60 1481w	945,40 1646w	1023,10 1811,00	1095,70 1975w	1199,60 2140w	1305,60 2304w	1421,80 2469w
F2V 68 (34t)	€	589,60 541w	648,40 722w	668,30 902w	711,60 1082w	762,20 1263w	856,50 1443w	950,20 1624w	1039,50 1804w	1122,10 1984w	1204,70 2165w	1319,40 2345w	1436,30 2526w	1564,10 2706w
F2V 74 (37t)	€	613,30 590w	707,80 786w	730,40 983w	775,90 1180w	833,10 1376w	932,80 1573w	1036,70 1769w	1133,90 1966w	1226,70 2163w	1314,50 2359w	1469,00 2556w	1598,50 2752w	1738,40 2949w
F2V 80 (40t)	€	656,00 638w	753,60 850w	793,30 1063w	840,10 1276w	903,10 1488w	1012,80 1701w	1122,10 1913w	1229,50 2126w	1329,40 2339w	1425,40 2551w	1561,50 2764w	1701,40 2976w	1849,50 3189w
F2V 86 (43t)	€	695,70 686w	800,40 914w	852,30 1143w	905,90 1372w	971,20 1600w	1092,10 1829w	1209,40 2057w	1324,30 2286w	1430,70 2515w	1534,20 2743w	1681,20 2972w	1832,10 3200w	1992,80 3429w
F2V 92 (46t)	€	743,50 733w	837,40 978w	911,80 1222w	968,60 1466w	1041,30 1711w	1168,70 1955w	1296,20 2200w	1418,40 2444w	1534,20 2688w	1644,70 2933w	1800,10 3177w	1960,40 3422w	2133,30 3666w
F2V 98 (49t)	€	788,00 781w	877,10 1042w	973,70 1302w	1035,10 1562w	1111,60 1823w	1247,60 2083w	1381,20 2344w	1509,60 2604w	1635,60 2864w	1754,50 3125w	1919,80 3385w	2090,30 3646w	2275,60 3906w
F2V 104 (52t)	€	824,10 829w	914,30 1105w	1014,20 1381w	1098,30 1657w	1181,20 1933w	1326,10 2210w	1466,60 2486w	1607,30 2762w	1737,10 3038w	1863,80 3314w	2040,90 3591w	2222,80 3867w	2416,20 4143w
F2V 110 (55t)	€	861,10 877w	951,60 1169w	1057,50 1461w	1163,50 1753w	1251,90 2045w	1403,20 2338w	1555,20 2630w	1701,40 2922w	1840,50 3214w	1973,00 3506w	2161,20 3799w	2353,80 4091w	2561,10 4383w
F2V 116 (58t)	€	897,10 925w	990,60 1233w	1113,30 1541w	1230,30 1849w	1319,40 2157w	1481,40 2466w	1641,90 2774w	1797,60 3082w	1944,80 3390w	2084,20 3698w	2284,20 4007w	2486,60 4315w	2703,10 4623w

Δt different from 50 K: consult Technical data Brem

PRODUCTION ON REQUEST

Thermal output and prices by interpolation:

- length of manifolds every 2 cm
- height of radiating tubes every 10 cm

Made-to-measure (± 3 mm)

Sizes over 3 m: price on request
Size every 1 cm: increased size +20%

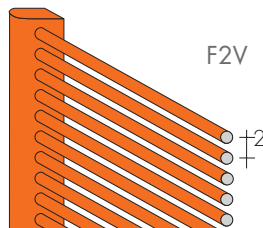

F2V

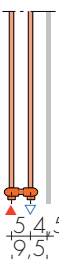

DOUBLE VERSION FDH and FDV is obtained by joining two F2H radiators
PRICE: F2H or F2V x 2 + 134,50€
THERMAL output: F2H or F2V x 1,60

Standard EG fitting: inlet on left, at front; return on right, at rear.

FORM FH DIMIS can be used as:

- partition wall with feet and fixings (p. 276)
- 15 cm H series foot Art. PF15 87,90€
- side fixings Art. F10 83,90€

FORM F3H and F3V has 3 cm between alternating pipes:

- dimensions as F2 every 6 cm
- RESE watt F2 x 1,16 - PRICES € F2 x 1,40

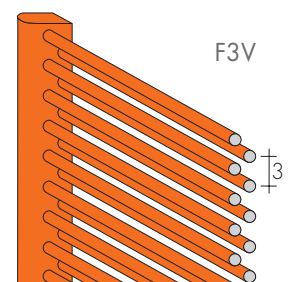

F3V

GRATA

design Luigi Brembilla

GRATA is a radiator of sought-after design and high thermal output. These characteristics make

the GRATA useful when a very decorative effect is needed, with the addition of feet and

clamps, allows it also to be used as a room partition, parapet or staircase handrail.

MODEL GRH
with vertical radiating tubes

H = from 60 to 300 cm (every 20 cm)
Height on request every 5 cm

L = from 20 to 110 cm (every 6 cm)
Width on request every 3 cm

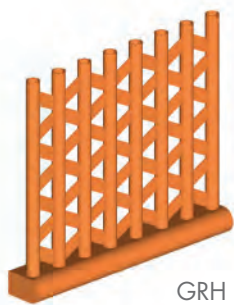

GRH

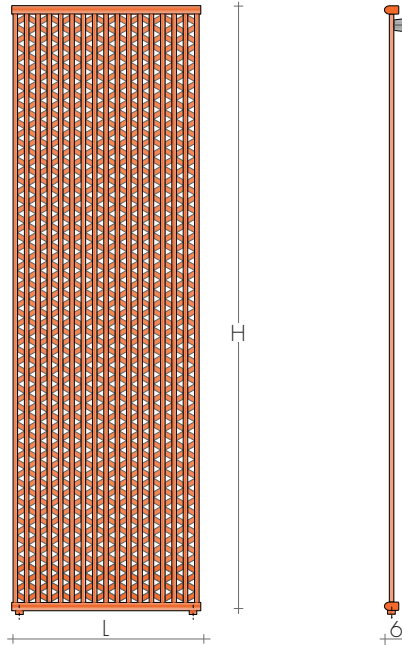

MODEL GRV
with horizontal radiating tubes

H = from 20 to 116 cm (every 6 cm)
Height on request every 3 cm

L = from 60 to 300 cm (every 20 cm)
Length on request every 5 cm

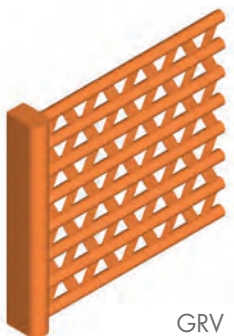

GRV

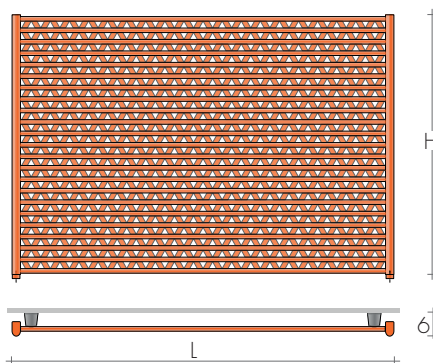

STANDARD PRODUCTION

White sablé SB9016 paintwork, M4G brackets
Air vent \varnothing 1/8" - Tolerance \pm 3 mm
MAXIMUM WORKING PRESSURE, 8 BAR

PRODUCTION ON REQUEST

Paintwork to Brem color list (with chrome-plated brackets) +15/25%
Made-to-measure, by estimate

STANDARD FITTINGS

EG \varnothing 1/2". A richiesta 3/8"
Fittings AC o BD on request
Special fittings, page 278

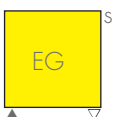

TAPPING CENTRES

EG vertical standard fittings
Side fittings, on request without extra

GRH MODEL

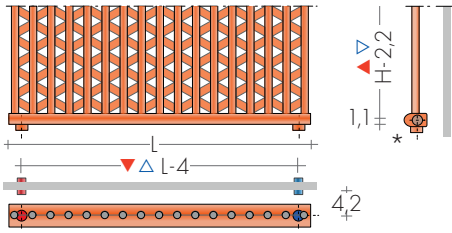

GRV MODEL

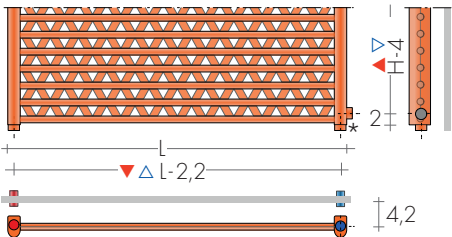

* Coupling protrudes 1cm

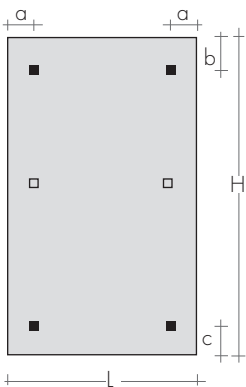

FIXINGS
Brackets included



Art. M4G

a from H or L 220 cm

Mod.	a cm	b cm	c cm
GRH	5,5	5	5
GRV	5	5,5	5,5



GRATA GRH 200-50

RECOMMENDED VALVES

CHROME VALVES KIT with:

- n°2 Valves with tailpieces
- n°2 Fittings (multilayer ø 16, copper ø 12, 14)
- n°2 Chrome wall plates ø 48, hole ø 16

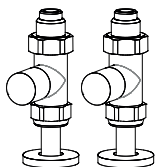

KIT STRAIGHT VALVES MINI
chrome-plated page 270 Art. KMD 136,90€

SPECIAL FINISHES

page 267
Finishes Gold, Bronze, Brushed Nickel for 2 valves
Brushed Nickel FITTING KIT extra Art. RN 30,50€

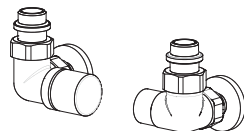

KIT SIDE control VALVES CYL with THERMOSTATIC
option, page 273 Art. KCL 162,50€
Extra for BREM color list 53,40€

REMOTE FITTINGS

Art. REM 42,10€
Tapping centres: at the rear of radiator ▲▼ EG
DISTANT Valves page 274

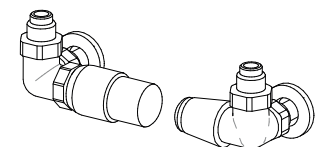
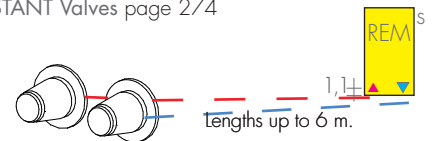

KIT SIDE control VALVES TON with Thermostatic
Head, page 269 Art. KTL 203,70€

GRATA GRH

EN 442 Watt Δt 50K (Δt 40K = Wx0,755) - (Δt 30K = Wx0,526)

MOD.	H cm	L cm	Lengths/Longueurs														
			20	26	32	38	44	50	56	62	68	74	80	86	92	98	104
	▲▼	cm	16	22	28	34	40	46	52	58	64	70	76	82	88	94	100
GRH 60	€		550,90 146w	619,40 190w	677,20 234w	731,80 278w	788,10 322w	854,80 366w	933,70 410w	1066,9 454w	1178,6 498w	1295,4 542w	1402,2 586w	1512,6 630w	1625,7 673w	1733,6 717w	1860,3 761w
GRH 80	€		583,50 187w	656,70 243w	715,00 299w	776,20 355w	831,80 411w	904,40 468w	957,50 524w	1129,3 580w	1241,2 636w	1355,3 692w	1467,0 748w	1579,8 804w	1672,7 860w	1806,2 916w	1926,0 972w
GRH 100	€		598,40 229w	677,20 297w	740,50 366w	800,40 435w	859,90 503w	930,80 572w	1050,6 641w	1165,8 709w	1278,0 778w	1395,0 847w	1515,0 915w	1629,3 984w	1743,7 1052w	1860,3 1121w	1975,2 1190w
GRH 120	€		635,90 268w	721,40 348w	787,50 429w	851,80 509w	914,40 590w	990,50 670w	1113,8 750w	1234,5 831w	1361,2 911w	1484,6 992w	1608,1 1072w	1731,2 1152w	1854,4 1233w	1977,5 1313w	2100,4 1394w
GRH 140	€		685,80 308w	776,20 400w	845,90 492w	914,4 585w	983,9 677w	1064,1 770w	1195,4 862w	1328,4 954w	1459,5 1047w	1591,4 1139w	1726,0 1231w	1858,4 1324w	1993,6 1416w	2126,2 1508w	2256,8 1601w
GRH 160	€		771,20 346w	871,10 449w	950,00 553w	1024,6 657w	1103,6 760w	1195,4 864w	1341,3 968w	1491,1 1071w	1638,0 1175w	1784,4 1279w	1937,0 1382w	2089,2 1486w	2238,0 1590w	2382,4 1693w	2534,0 1797w
GRH 180	€		851,80 383w	961,30 497w	1047,5 612w	1136,4 727w	1221,6 842w	1323,6 957w	1487,4 1071w	1652,4 1186w	1814,8 1301w	1980,2 1416w	2147,6 1530w	2311,6 1645w	2478,0 1760w	2641,4 1875w	2802,8 1990w
GRH 190	€		890,30 404w	1008,8 525w	1097,3 647w	1189,9 758w	1278,8 889w	1385,9 1011w	1555,3 1132w	1730,0 1253w	1899,9 1374w	2074,2 1496w	2249,4 1617w	2420,8 1738w	2594,7 1859w	2764,6 1981w	2937,4 2102w
GRH 200	€		930,80 419w	1054,1 545w	1147,9 671w	1244,5 796w	1337,4 922w	1447,8 1048w	1627,1 1174w	1806,9 1300w	1985,3 1425w	2166,9 1551w	2351,1 1677w	2531,1 1803w	2711,3 1928w	2886,0 2054w	3072,4 2180w
GRH 210	€		967,50 429w	1095,8 557w	1195,4 686w	1294,5 815w	1390,8 943w	1507,6 1072w	1694,7 1201w	1882,5 1329w	2067,5 1458w	2256,8 1587w	2445,9 1715w	2633,8 1844w	2823,6 1972w	3006,4 2101w	3197,9 2230w
GRH 220	€		1007,7 453w	1140,4 589w	1241,2 724w	1343,3 860w	1445,1 996w	1566,0 1132w	1760,0 1268w	1956,2 1404w	2147,6 1540w	2344,8 1675w	2539,9 1811w	2737,3 1947w	2932,7 2083w	3125,7 2219w	3322,7 2355w
GRH 240	€		1082,5 486w	1224,7 632w	1333,5 777w	1442,7 923w	1553,6 1069w	1681,3 1215w	1888,8 1360w	2095,6 1506w	2304,0 1652w	2514,7 1797w	2726,5 1943w	2932,7 2089w	3145,9 2235w	3354,7 2380w	3562,4 2526w
GRH 260	€		1187,4 517w	1341,3 672w	1461,6 827w	1581,6 982w	1701,7 1137w	1843,2 1293w	2065,3 1448w	2293,5 1603w	2522,2 1758w	2808,4 1913w	2984,6 2068w	3216,0 2223w	3442,0 2378w	3671,5 2533w	3902,1 2688w
GRH 280	€		1290,2 548w	1459,5 712w	1588,8 877w	1722,1 1041w	1850,2 1206w	2002,8 1370w	2251,8 1534w	2497,3 1699w	2749,6 1863w	3055,7 2028w	3251,2 2192w	3502,6 2356w	3747,7 2521w	3997,1 2685w	4247,3 2850w
GRH 300	€		1402,2 577w	1585,1 750w	1728,4 923w	1869,6 1096w	2012,2 1269w	2177,2 1443w	2448,4 1616w	2718,1 1789w	2991,0 1962w	3325,3 2135w	3538,4 2308w	3810,2 2481w	4078,3 2654w	4349,9 2827w	4619,6 3000w

Δt different from 50 K: consult Technical data Brem

HOW TO ORDER

State: model, height and width in cm; connection and color if different from standard.
eg.: GRH 180 - 38, AC \varnothing 3/8", SB 2008

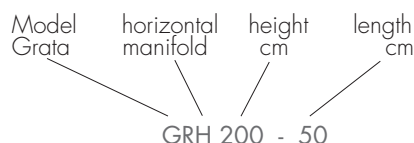

PRODUCTION ON REQUEST

Thermal output and prices can be obtained by interpolation:
- length of manifolds every 3 cm
- height of radiating tubes every 10 cm

Made-to-measure (± 3 mm)

Sizes over 3 m: price on request
Height every 5 cm: increased size +15%

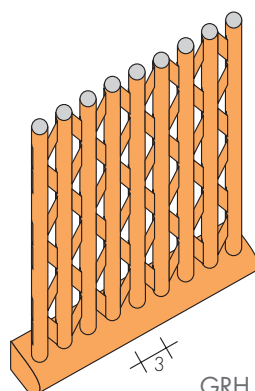

GRH

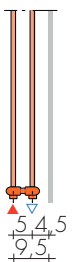

DOUBLE VERSION GDH

Is obtained by joining two GRH radiators
PRICE GDH GRH x 2 + 134,50€
Standard EG fitting (delivery on left, at front; return on right, at rear).
Thermal output GDH: single radiator x 1,60

GRATA GRV

EN 442 Watt Δt 50K (Δt 40K = $W \times 0,755$) - (Δt 30K = $W \times 0,526$)

MOD.	L cm ▲▼ cm	60	80	100	120	140	Lengths/Longueurs		200	220	240	260	280	300
		57,8	77,8	97,8	117,8	137,8	160	180	197,8	217,8	237,8	257,8	277,8	297,8
GRV 20	€	491,90 131w	521,00 174w	534,30 218w	567,80 262w	612,30 305w	688,60 349w	760,50 392w	831,10 436w	899,70 480w	966,50 523w	1060,2 567w	1152,0 610w	1252,0 654w
GRV 26	€	553,00 172w	586,30 229w	604,60 286w	644,10 343w	693,00 400w	777,80 458w	858,30 515w	941,20 572w	1018,20 629w	1093,50 686w	1197,6 744w	1303,1 801w	1415,3 858w
GRV 32	€	604,60 212w	638,40 283w	661,20 354w	703,10 425w	755,30 496w	848,20 566w	935,30 637w	1024,9 708w	1108,2 779w	1190,6 850w	1305,0 920w	1418,6 991w	1543,2 1062w
GRV 38	€	653,40 254w	693,00 338w	714,60 423w	760,50 508w	816,40 592w	914,80 677w	1014,6 761w	1111,2 846w	1199,4 931w	1288,1 1015w	1412,1 1100w	1537,6 1184w	1669,3 1269w
GRV 44	€	703,70 295w	742,70 393w	767,80 491w	816,40 589w	878,50 687w	985,40 786w	1090,7 884w	1194,1 982w	1290,3 1080w	1387,1 1178w	1519,4 1277w	1652,0 1375w	1796,6 1473w
GRV 50	€	763,20 336w	807,50 448w	831,10 560w	884,40 672w	950,10 784w	1067,3 896w	1181,8 1008w	1292,7 1120w	1398,2 1232w	1501,2 1344w	1645,7 1456w	1788,2 1568w	1943,9 1680w
GRV 56	€	833,70 377w	854,90 503w	938,00 629w	994,50 755w	1067,3 881w	1197,6 1006w	1328,0 1132w	1452,8 1258w	1571,4 1384w	1686,4 1510w	1844,0 1635w	2010,5 1761w	2186,1 1887w
GRV 62	€	952,60 420w	1008,3 560w	1040,9 700w	1102,2 840w	1186,1 980w	1331,3 1120w	1475,4 1260w	1613,3 1400w	1746,6 1540w	1871,1 1680w	2047,8 1820w	2229,7 1960w	2426,9 2100w
GRV 68	€	1052,3 461w	1108,2 615w	1141,1 769w	1215,4 923w	1303,1 1077w	1462,5 1230w	1620,4 1384w	1772,6 1538w	1917,5 1692w	2057,1 1846w	2252,0 1999w	2455,0 2153w	2670,5 2307w
GRV 74	€	1156,6 503w	1210,1 670w	1245,5 838w	1325,5 1006w	1420,9 1173w	1593,2 1341w	1768,0 1508w	1934,7 1676w	2093,6 1844w	2245,3 2011w	2507,5 2179w	2728,3 2346w	2969,0 2514w
GRV 80	€	1252,0 545w	1309,8 726w	1352,7 908w	1435,8 1090w	1541,1 1271w	1729,5 1453w	1917,5 1634w	2099,2 1816w	2267,8 1998w	2434,4 2179w	2664,8 2361w	2902,9 2542w	3159,3 2724w
GRV 86	€	1350,5 586w	1410,5 782w	1454,7 977w	1545,7 1172w	1659,3 1368w	1865,4 1563w	2063,9 1759w	2259,9 1954w	2444,0 2149w	2618,5 2345w	2871,4 2540w	3127,3 2736w	3402,0 2931w
GRV 92	€	1451,5 628w	1493,5 837w	1556,9 1046w	1655,7 1255w	1780,0 1464w	1998,2 1674w	2212,5 1883w	2420,8 2092w	2618,5 2301w	2808,8 2510w	3073,2 2720w	3346,2 2929w	3641,3 3138w
GRV 98	€	1547,9 669w	1612,7 892w	1661,0 1115w	1765,6 1338w	1898,4 1561w	2127,1 1784w	2358,4 2007w	2576,8 2230w	2790,8 2453w	2995,3 2676w	3278,1 2899w	3568,8 3122w	3883,8 3345w
GRV 104	€	1661,0 710w	1719,6 947w	1763,6 1184w	1875,4 1421w	2015,0 1658w	2262,5 1894w	2502,5 2131w	2743,2 2368w	2966,7 2605w	3180,7 2842w	3484,0 3078w	3792,2 3315w	4124,6 3552w
GRV 110	€	1757,9 752w	1810,1 1002w	1854,1 1253w	1985,2 1504w	2136,6 1754w	2396,3 2005w	2652,3 2255w	2902,9 2506w	3141,3 2757w	3371,4 3007w	3691,6 3258w	4018,6 3508w	4371,3 3759w
GRV 116	€	1856,2 793w	1910,8 1058w	1966,1 1322w	2102,6 1586w	2252,0 1851w	2529,0 2115w	2804,1 2380w	3068,7 2644w	3318,3 2908w	3561,0 3173w	3899,5 3437w	4244,6 3702w	4616,4 3966w

Δt different from 50 K: consult Technical data Brem



PRODUCTION ON REQUEST

Thermal output and prices can be obtained by interpolation:

- height of manifolds every 3 cm
- length of radiating tubes every 10 cm

Made-to-measure (± 3 mm)

Sizes over 3 m: price on request
Height every 5 cm: increased size +15%

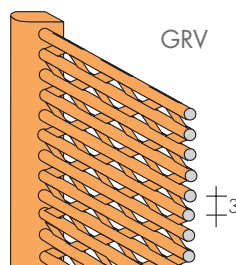

DOUBLE VERSION GDV

Is obtained by joining two GRV radiators
PRICE GDV GRV x 2 +134,50€

Standard EG fitting (delivery on left, at front; return on right, at rear).

Thermal output GDV: single radiator x1,65

RING RGH

RINGH is a radiator produced with 20 x 20 mm square radiant tubes and round horizontal

collectors. The numerous sizes available and the high thermal output thanks to the

version with double radiant tubes, make it the ideal radiator to be installed in any room.

DIMENSIONS mod. RGH e RGDH

Heights: from 160 to 220 cm, every 20 cm

Widths: from 28 to 70 cm, every 3,5 cm

Depth: 5 / 7 cm

Sporgenza dal muro: 8 / 8,5 cm

RGH and RGDH MODEL
with vertical radiating tubes

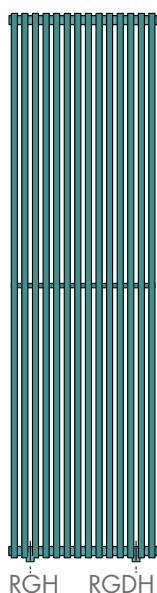
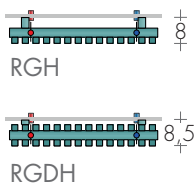

RGH

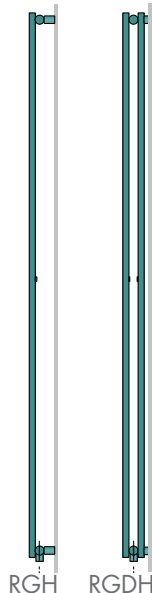

RGDH

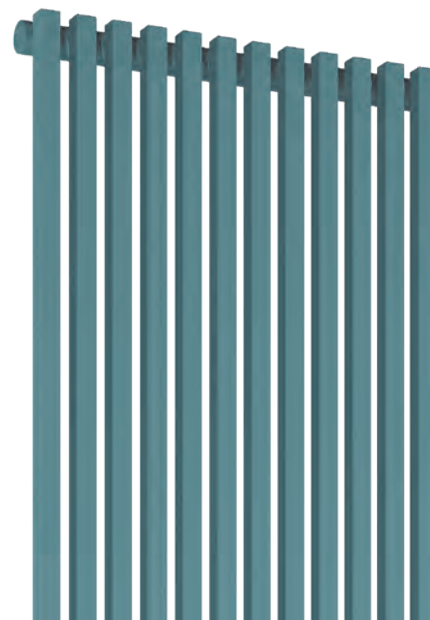

MODEL	n. el	8 el	9 el	10 el	11 el	12 el	13 el	14 el	15 el	16 el	17 el	18 el	19 el	20 el
H cm	L cm	28	31,5	35	38,5	42	45,5	49	52,5	56	59,5	63	66,5	70
	▲▼ cm	14	17,5	21	24,5	28	31,5	35	38,5	42	45,5	49	52,5	56
RGH 160	€	472,00 567w	493,60 638W	515,20 708W	536,80 779W	558,40 850W	580,20 921W	601,70 991W	623,30 1062W	644,80 1133W	666,40 1204W	688,10 1275W	709,70 1346W	731,40 1416W
RGDH 160	€	717,90 838w	748,60 943W	779,20 1047W	809,90 1152W	840,40 1257W	871,10 1362W	901,70 1466W	932,40 1571W	963,00 1676W	993,80 1781W	1024,40 1885W	1055,00 1990W	1085,70 2095W
RGH 180	€	501,00 634w	523,70 713W	546,30 792W	569,20 872W	591,90 951W	614,50 1030W	637,30 1109W	660,10 1189W	682,80 1268W	705,50 1347W	728,20 1426W	750,80 1505W	773,60 1584W
RGDH 180	€	764,00 939w	796,00 1056W	828,10 1174W	860,30 1291w	892,30 1409w	924,40 1526w	956,60 1643w	988,60 1761w	1020,80 1878w	1052,90 1995w	1084,90 2113w	1117,20 2230W	1149,30 2348w
RGH 200	€	530,00 701w	554,00 789W	577,80 876W	601,70 964w	625,40 1051w	649,30 1139w	673,00 1227w	696,90 1315w	720,60 1402w	744,60 1490w	768,40 1577w	792,20 1665w	815,90 1752w
RGDH 200	€	809,80 1040w	843,50 1170w	877,00 1300w	910,60 1430w	944,20 1560w	977,80 1690w	1011,20 1820w	1044,80 1950w	1078,40 2080w	1112,00 2210w	1145,60 2340w	1179,20 2470w	1212,80 2600w
RGH 220	€	559,10 768w	584,00 864w	608,90 960w	633,90 1056w	658,80 1152w	683,80 1248w	708,60 1344w	733,60 1440w	758,60 1536w	783,60 1632w	808,50 1728w	833,40 1824w	858,30 1920w
RGDH 220	€	855,80 1141w	890,80 1284w	925,90 1427w	961,00 1569w	995,90 1712w	1031,00 1855w	1066,00 1997w	1101,10 2140w	1136,10 2283w	1171,20 2425w	1206,20 2568w	1241,40 2711w	1276,50 2853w

STANDARD PRODUCTION

White sablé SB9016 paintwork, brackets white
Tolerance ± 3mm - Air vent ø 1/8"

MAXIMUM OPERATING PRESSURE 6 BAR

PRODUCTION ON REQUEST

Paintwork to Brem color list with
colored B.. brackets

Electric version, not available

+15/25%

STANDARD FITTING

EG ø 1/2"

Other fittings, on request



TAPPING CENTRES

Mod. RGH e RGDH, with vertical tubes

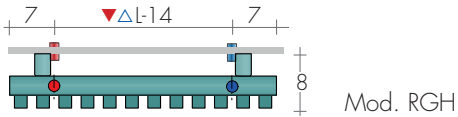
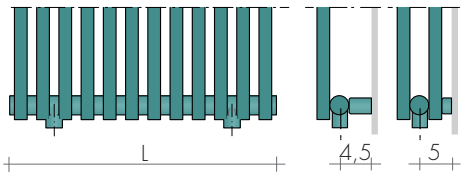

Mod. RGH

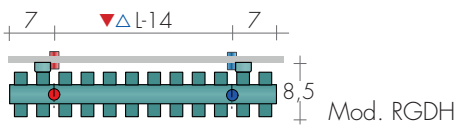

Mod. RGDH

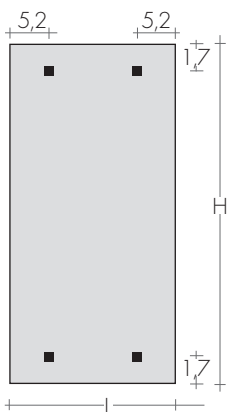

FIXINGS
Brackets included

Mod. brackets
RGH G30
RGDH B15



RING RGH 180-42

RECOMMENDED VALVES

CHROME VALVES KIT with:

- n°2 Valves with tailpieces
- n°2 Fittings (multilayer $\varnothing 16$, copper $\varnothing 12, 14$)
- n°2 Chrome wall plates $\varnothing 48$, hole $\varnothing 16$

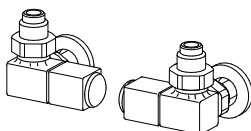

KIT SIDE control VALVES QUADRA
page 271 Art. KQL 191,20€
Extra for BREM color list 53,40€

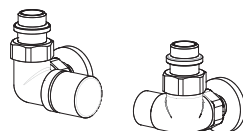

KIT SIDE control VALVES CYL with THERMOSTATIC
option, page 273 Art. KCL 162,50€
Extra for BREM color list 53,40€

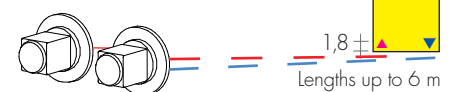

SPECIAL FINISHES page 267
Finishes Gold, Bronze, Brushed Nickel for 2 valves
Brushed Nickel FITTING KIT extra Art. RN 30,50€

REMOTE FITTINGS Art. REM 42,10€
Tapping centres: at the rear $\blacktriangle \nabla$ EG (only mod. RGH)
DISTANT Valves page 274

KIT SIDE control VALVES TON with Thermostatic
Head, page 269 Art. KTL 203,70€

RING RGV

RING-V is a radiator with 20 x 20mm square radiating tubes, and vertical collectors, for

classic use under a window. This is the ideal radiator for any setting as it comes in a variety

of sizes, as well as offering great heat output in the version with double radiating tubes.

DIMENSIONS mod. RGV e RGDV

Lengths: from 50 to 220 cm
 Heights: 49/63/70/91 cm
 Depth: 5 / 7 cm
 Depth from wall: 8 / 8,5 cm

RGV and RGDV MODEL with horizontal radiating tubes



RGV



RGDV



RGV RGDV

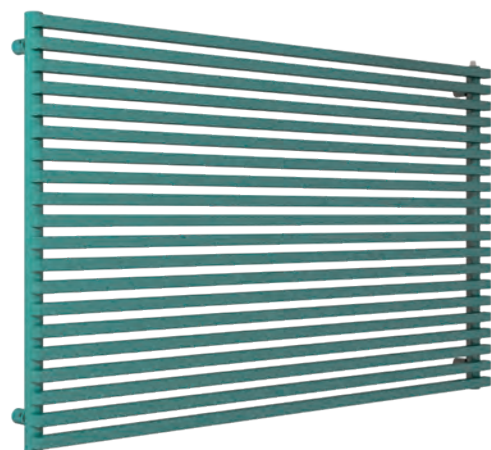

MODEL	H cm	n. el	Lcm ▲▼ cm	50	60	70	80	90	100	120	140	160	180	200	220
				€	46,5	56,5	66,5	76,5	86,5	96,5	116,5	136,5	156,5	176,5	196,5
RGV	49	14	€	458,30	468,60	478,90	436,80	446,00	455,30	473,70	492,00	510,50	528,90	547,40	565,70
				349w	408w	468w	528w	587w	647w	766w	885w	1004w	1123w	1242w	1361w
RGDV	49	14	€	627,50	648,80	670,00	691,30	712,50	733,70	776,30	818,70	861,20	903,60	946,20	988,60
				499w	589w	678w	768w	858w	947w	1126w	1305w	1485w	1664w	1843w	2022w
RGV	63	18	€	535,40	545,80	556,10	505,90	515,20	524,50	543,20	561,80	580,30	598,90	617,60	636,20
				449w	525w	602w	678w	755w	831w	984w	1138w	1291w	1444w	1597w	1750w
RGDV	63	18	€	805,20	820,70	836,20	851,60	867,10	882,60	913,50	944,50	975,40	1006,40	1037,30	1068,30
				642w	757w	872w	987w	1103w	1218w	1448w	1678w	1909w	2139w	2370w	2600w
RGV	70	20	€	573,20	583,60	594,30	539,90	549,40	558,70	577,50	596,30	615,10	633,80	652,60	671,40
				499w	584w	669w	754w	839w	924w	1094w	1264w	1434w	1604w	1774w	1944w
RGDV	70	20	€	865,80	880,50	895,60	910,30	925,10	940,10	969,70	999,50	1029,30	1059,00	1088,60	1118,40
				713w	841w	969w	1097w	1225w	1353w	1609w	1865w	2121w	2377w	2633w	2889w
RGV	91	26	€	595,70	612,30	628,90	576,50	591,30	606,10	635,70	665,40	695,00	724,60	754,30	783,90
				648w	759w	869w	980w	1090w	1201w	1422w	1643w	1864w	2085w	2307w	2528w
RGDV	91	26	€	871,60	895,40	919,30	943,30	967,10	990,30	1038,90	1086,60	1134,40	1182,30	1230,10	1277,80
				927w	1093w	1260w	1426w	1593w	1759w	2092w	2424w	2757w	3090w	3423w	3755w

MEASURES ON REQUEST: Lengths every 10 cm from 50 to 220 cm (values by interpolation) - NUMBER OF ELEMENTS from 8 to 30

STANDARD PRODUCTION

White sablé SB9016 paintwork, brackets white
 Tolerance ± 3mm - Air vent ø 1/8"
 MAXIMUM OPERATING PRESSURE 6 BAR

PRODUCTION ON REQUEST

Paintwork to Brem color list with
 colored B.. brackets
 Electric version, not available

+15/25%

STANDARD FITTING

EG ø 1/2"

Other fittings, on request



TAPPING CENTRES

Mod. RGV e RGDV, with horizontal tubes

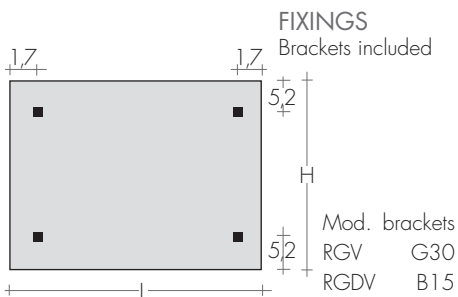
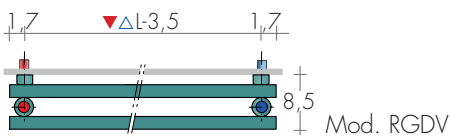
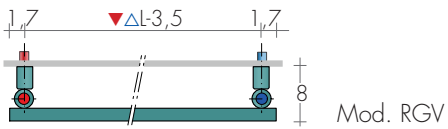
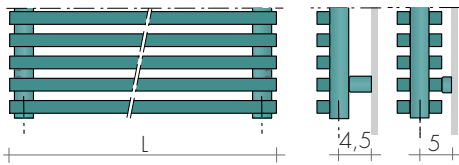

RECOMMENDED VALVES

CHROME VALVES KIT with:

- n°2 Valves with tailpieces
- n°2 Fittings (multilayer ø 16, copper ø 12, 14)
- n°2 Chrome wall plates ø 48, hole ø 16

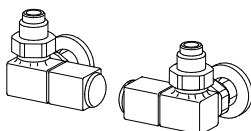

KIT SIDE control VALVES QUADRA
page 271 Art. KQL 191,20€
Extra for BREM color list 53,40€

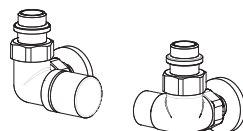

KIT SIDE control VALVES CYL with THERMOSTATIC
option, page 273 Art. KCL 162,50€
Extra for BREM color list 53,40€

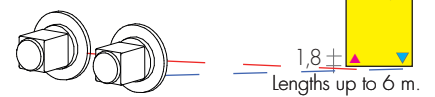

SPECIAL FINISHES page 267
Finishes Gold, Bronze, Brushed Nickel for 2 valves
Brushed Nickel FITTING KIT extra Art. RN 30,50€

REMOTE FITTINGS Art. REM 42,10€
Tapping centres: at the rear ▲▽ EG (only mod. RGV)
DISTANT Valves page 274

KIT SIDE control VALVES TON with Thermostatic
Head, page 269 Art. KTL 203,70€

WIND

design Luigi Brembilla

The WIND mini-column radiators are built using elements from three to six columns,

made from circular cross section radiating tubes. Depending on the number requested,

the batteries of elements are obtained by welding the required number together.

ELEMENT STEP: PE = 3 cm

TUBES DIAMETER: $\varnothing = 1,5$ cm

LENGTH OF RADIATORS (± 3 mm):
number of elements x 3 cm

Rear metal reinforcement from 21 elements

H = from 29 to 200 cm

L = from 30 to 108 cm (every 3 cm)

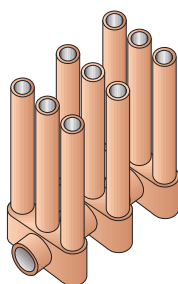

MODEL W 3 with 3 radiating tubes element

MODEL W 4 with 4 radiating tubes element

MODEL W 5 with 5 radiating tubes element

MODEL W 6 with 6 radiating tubes element

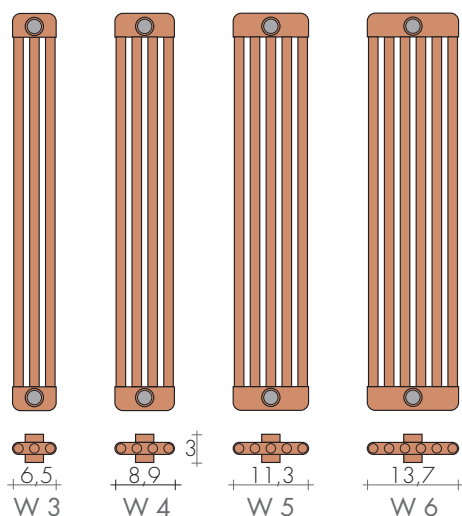

STANDARD TAPPING CENTRES

AC - BD / AD - BC $\varnothing 1/2''$

Side fittings $\blacktriangle \nabla = H-4,6$ cm

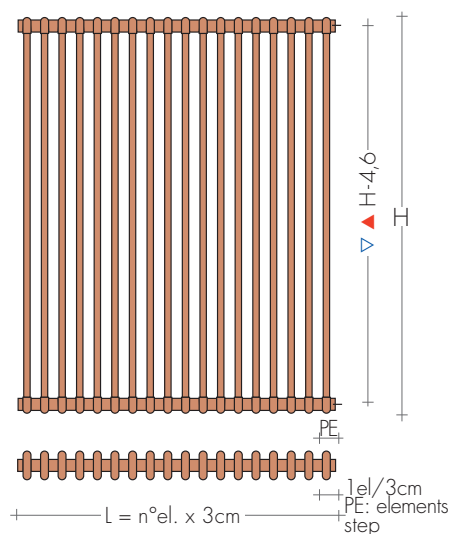

TAPPING CENTRES ± 6 CM

Use chrome-plated offset couplings to adjust the tapping centres up to 6 cm (Art. EC.. page 278)



STANDARD PRODUCTION

SB9016 white sablé paintwork, with brackets
Air vent $\varnothing 1/2''$ - Tolerance ± 3 mm
MAXIMUM WORKING PRESSURE, 8 BAR

PRODUCTION ON REQUEST

Brem color chart painting with brackets
in the same color +15/25%
Batteries with non standard n° of elements.

STANDARD FITTINGS

AC - BD / AD - BC $\varnothing 1/2''$
Fittings EG or GE on request
Special fittings, page 278

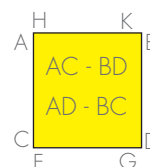

SPECIAL FITTINGS ON REQUEST

Connections EG ø 1/2" (GE) with sleeve and baffle
Art. AS 91,20€

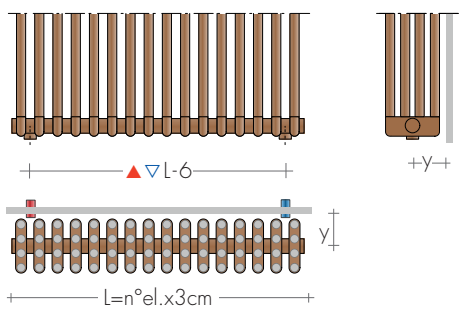

W 3 y = 5 cm W 5 y = 7 cm
W 4 y = 5,5 cm W 6 y = 7,5 cm

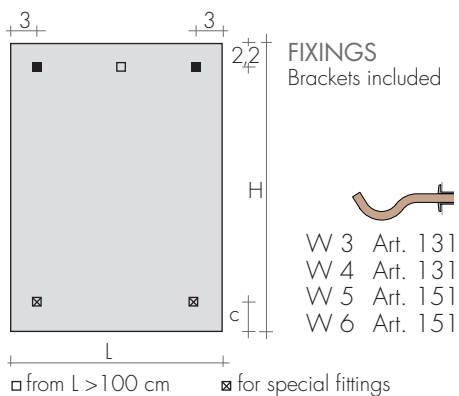

WIND 3200 12 el.

RECOMMENDED VALVES

CHROME VALVES KIT with:

- n°2 Valves with tailpieces
- n°2 Fittings (multilayer ø 16, copper ø 12, 14)
- n°2 Chrome wall plates ø 48, hole ø 16

SPECIAL FINISHES page 267
Finishes Gold, Bronze, Brushed Nickel for 2 valves
Brushed Nickel FITTING KIT extra Art. RN 30,50€

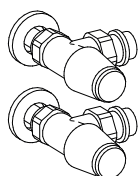

ANGLED TON VALVES KIT
page 269

Art. KVS 137,10€

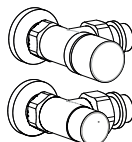



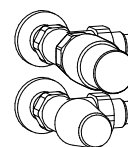







KIT ANGLED VALVES CYL with thermostatic option
page 273 Art. KCS 149,90€
Extra for BREM color list 53,40€



KIT ANGLED VALVES TON with THERMOSTATIC
Head, page 269 Art. KTS 190,30€

WIND

MOD.	H cm	▲▽ cm	p cm	n° el L cm	EN 442 Watt Δt 50K (Δt 40K = $W \times 0,755$) - (Δt 30K = $W \times 0,526$)															
					1el (3)	10el (30)	11el (33)	12el (36)	13el (39)	14el (42)	15el (45)	16el (48)	17el (51)	18el (54)	19el (57)	20el (60)				
W 3065		66,6	62	6,5	€ 30,80	306,20	336,80	367,40	397,80	428,50	459,40	490,00	520,50	551,00	581,60	612,30				
W 3075		76,6	72	6,5	€ 32,50	323,50	355,80	388,20	420,70	452,80	485,20	517,40	549,80	582,10	614,70	646,70				
W 3085		86,6	82	6,5	€ 34,00	340,40	374,60	408,80	443,10	476,90	511,10	545,20	579,30	613,20	647,10	681,50				
W 3180		178,3	173,7	6,5	€ 66,00	656,40	721,80	787,50	853,20	918,70	984,50	1049,8	1115,7	1181,3	1246,9	1312,4				
W 3200		198,3	193,7	6,5	€ 73,40	733,30	806,40	879,80	952,90	1026,5	1099,7	1173,2	1246,1	1319,6	1392,7	1466,2				
W 4065		66,6	62	8,9	€ 35,10	349,30	384,20	419,10	454,20	489,20	523,90	559,00	594,00	629,10	663,70	698,80				
W 4075		76,6	72	8,9	€ 37,00	366,80	403,40	439,90	476,70	513,20	549,80	586,70	623,20	659,80	696,30	733,20				
W 4085		86,6	82	8,9	€ 38,30	383,70	422,20	460,50	499,10	537,50	575,90	614,10	652,10	690,60	729,00	767,50				
W 4180		178,3	173,7	8,9	€ 71,50	714,40	786,00	857,50	928,70	1000,0	1071,7	1143,1	1214,3	1285,9	1357,2	1428,7				
W 4200		198,3	193,7	8,9	€ 79,50	797,10	876,60	956,40	1036,1	1115,7	1195,4	1275,0	1354,8	1434,5	1514,4	1593,8				
W 5027		29,1	24,5	11,3	€ 33,80	338,80	372,30	406,00	440,30	473,80	507,80	541,90	575,60	609,50	643,10	676,90				
W 5053		54,6	50	11,3	€ 38,90	388,20	427,10	465,60	504,70	543,20	582,10	621,40	659,80	698,80	737,40	776,40				
W 5065		66,6	62	11,3	€ 39,40	394,80	434,20	473,40	513,00	552,40	591,80	631,20	671,10	710,30	749,60	789,30				
W 5075		76,6	72	11,3	€ 41,60	416,40	457,60	499,60	541,10	582,70	624,10	665,60	707,40	749,30	790,70	832,40				
W 5085		86,6	82	11,3	€ 42,90	429,20	472,10	514,90	557,80	600,50	643,40	686,70	729,10	772,50	815,10	858,10				
W 6027		29,1	24,5	13,7	€ 37,20	368,70	405,40	442,70	479,00	516,50	553,30	589,90	626,90	663,70	700,30	737,40				
W 6053		54,6	50	13,7	€ 43,50	433,30	476,80	520,20	563,40	606,70	650,00	693,30	736,80	780,00	823,40	867,00				
W 6065		66,6	62	13,7	€ 44,70	446,40	490,80	535,50	580,60	625,10	669,60	714,30	759,00	803,50	848,20	892,80				
W 6075		76,6	72	13,7	€ 46,30	463,60	509,90	556,40	602,80	649,30	695,40	741,70	788,00	834,50	881,10	927,20				
W 6085		86,6	82	13,7	€ 48,40	481,20	528,90	577,10	625,20	673,00	721,30	769,20	817,60	865,50	913,70	961,60				

HOW TO ORDER

State: model, number of columns, height in cm, number of elements; connection and color.

Mod. Wind number columns height cm number elements

W 3075 - 19 el

E.g.: W 3075 -19, AC 1/2", BRO007

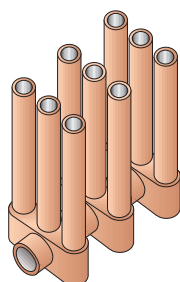

PRODUCTION ON REQUEST

3 - 9 el. batteries extra charge 29,00€
Batteries with more than 40 el.

extra charge for each radiator 62,20€

EN 442 Watt Δt 50K (Δt 40K = $W \times 0,755$) - (Δt 30K = $W \times 0,526$)

21el (63)	22el (66)	23el (69)	24el (72)	25el (75)	26el (78)	27el (81)	28el (84)	29el (87)	30el (90)	31el (93)	32el (96)	33el (99)	34el (102)	35el (105)	36el (108)	MOD. H cm
643,00 875w	673,70 917w	704,00 959w	734,80 1001w	765,40 1042w	796,10 1084w	826,70 1126w	857,10 1167w	887,80 1209w	918,50 1251w	949,10 1292w	979,60 1334w	1010,4 1376w	1040,8 1417w	1071,7 1459w	1102,5 1501w	€ W 3065
679,20 1017w	711,30 1066w	744,20 1114w	776,40 1163w	808,80 1211w	840,80 1260w	873,40 1308w	905,60 1357w	938,20 1405w	970,30 1453w	1002,7 1502w	1035,0 1550w	1067,4 1599w	1099,8 1647w	1132,2 1696w	1164,5 1744w	€ W 3075
715,20 1136w	749,50 1190w	783,70 1244w	817,70 1298w	851,60 1352w	885,50 1406w	919,70 1460w	954,00 1514w	988,00 1568w	1022,1 1622w	1056,0 1677w	1090,3 1731w	1124,1 1785w	1158,3 1839w	1192,6 1893w	1226,4 1947w	€ W 3085
1378,2 2248w	1443,8 2355w	1509,4 2462w	1575,1 2569w	1640,8 2676w	1706,1 2783w	1771,7 2890w	1837,6 2997w	1903,1 3104w	1968,8 3211w	2034,3 3318w	2099,9 3425w	2165,9 3532w	2231,3 3639w	2297,0 3746w	2362,3 3853w	€ W 3180
1539,7 2484w	1612,8 2603w	1686,2 2721w	1759,3 2839w	1832,8 2958w	1906,1 3076w	1979,4 3194w	2052,7 3312w	2126,1 3431w	2199,2 3549w	2272,7 3667w	2345,8 3786w	2419,2 3904w	2492,6 4022w	2565,8 4141w	2639,3 4259w	€ W 3200
733,40 1088w	768,40 1140w	803,50 1192w	838,10 1244w	873,40 1296w	908,50 1348w	943,20 1399w	978,10 1451w	1013,2 1503w	1047,9 1555w	1082,6 1607w	1117,8 1659w	1152,6 1710w	1187,5 1762w	1222,7 1814w	1257,3 1866w	€ W 4065
770,00 1254w	806,40 1314w	843,20 1373w	879,30 1433w	916,70 1493w	953,00 1553w	990,00 1612w	1026,6 1672w	1063,0 1732w	1099,8 1791w	1136,4 1851w	1172,9 1911w	1209,8 1971w	1246,1 2030w	1283,1 2090w	1319,6 2150w	€ W 4075
805,70 1420w	844,30 1487w	882,60 1555w	921,20 1622w	959,40 1690w	997,70 1758w	1036,1 1825w	1074,3 1893w	1112,8 1960w	1151,4 2028w	1189,9 2096w	1228,4 2163w	1266,7 2231w	1305,2 2298w	1343,6 2366w	1381,9 2434w	€ W 4085
1500,2 2745w	1571,5 2875w	1642,9 3006w	1714,5 3137w	1786,0 3267w	1857,4 3398w	1928,8 3529w	2000,0 3660w	2071,7 3790w	2143,0 3921w	2214,7 4052w	2285,8 4182w	2357,4 4313w	2428,8 4444w	2500,3 4574w	2571,5 4705w	€ W 4180
1673,5 3052w	1753,0 3198w	1832,8 3343w	1912,5 3488w	1992,4 3634w	2071,9 3779w	2151,7 3924w	2231,3 4070w	2311,0 4215w	2390,6 4360w	2470,5 4506w	2549,9 4651w	2629,6 4796w	2709,5 4942w	2789,0 5087w	2868,8 5232w	€ W 4200
711,00 568w	744,70 595w	778,70 622w	812,40 649w	846,30 676w	880,00 703w	914,10 730w	947,70 757w	982,00 784w	1015,7 811w	1049,4 838w	1083,5 865w	1117,0 892w	1150,9 919w	1185,0 946w	1218,6 973w	€ W 5027
815,00 1112w	854,10 1165w	892,80 1218w	931,40 1271w	970,30 1324w	1009,1 1377w	1047,9 1430w	1086,8 1483w	1125,6 1536w	1164,5 1589w	1203,3 1642w	1242,0 1695w	1280,9 1748w	1319,6 1800w	1358,4 1853w	1397,3 1906w	€ W 5053
828,60 1325w	868,00 1388w	907,30 1451w	947,20 1514w	986,50 1577w	1026,1 1640w	1065,5 1704w	1105,0 1767w	1144,4 1830w	1183,8 1893w	1223,4 1956w	1262,8 2019w	1302,0 2082w	1341,5 2145w	1381,1 2208w	1420,4 2271w	€ W 5065
873,90 1538w	915,40 1611w	957,30 1684w	998,80 1758w	1040,1 1831w	1082,0 1904w	1123,5 1977w	1165,2 2051w	1206,7 2124w	1248,7 2197w	1290,0 2270w	1331,7 2344w	1373,3 2417w	1414,9 2490w	1456,3 2563w	1498,0 2636w	€ W 5075
901,00 1727w	944,20 1809w	986,80 1892w	1029,7 1974w	1073,0 2056w	1115,5 2138w	1158,6 2221w	1201,4 2303w	1244,5 2385w	1287,3 2467w	1330,0 2550w	1372,8 2632w	1416,0 2714w	1458,9 2796w	1501,5 2879w	1544,7 2961w	€ W 5085
774,30 710w	811,10 744w	848,20 777w	885,00 811w	922,00 845w	958,60 879w	995,70 913w	1032,3 946w	1069,3 980w	1106,2 1014w	1143,0 1048w	1179,8 1082w	1216,5 1115w	1253,7 1149w	1290,5 1183w	1327,3 1217w	€ W 6027
910,00 1349w	953,80 1413w	996,60 1477w	1040,0 1541w	1083,6 1606w	1127,1 1670w	1169,8 1734w	1213,5 1798w	1256,8 1862w	1300,3 1927w	1343,7 1991w	1387,0 2055w	1430,2 2119w	1473,5 2184w	1517,0 2248w	1560,3 2312w	€ W 6053
937,30 1609w	982,10 1686w	1026,7 1762w	1070,9 1839w	1116,0 1915w	1160,5 1992w	1204,8 2069w	1249,6 2145w	1294,5 2222w	1339,2 2298w	1383,3 2375w	1428,1 2452w	1473,1 2528w	1517,5 2605w	1562,2 2682w	1606,8 2758w	€ W 6065
973,60 1846w	1020,1 1933w	1066,1 2021w	1112,5 2109w	1159,1 2197w	1205,6 2285w	1251,7 2373w	1298,1 2461w	1344,4 2549w	1390,8 2636w	1437,1 2724w	1483,4 2812w	1529,6 2900w	1576,6 2988w	1622,7 3076w	1669,1 3164w	€ W 6075
1009,8 2035w	1057,7 2132w	1105,7 2229w	1154,2 2326w	1202,0 2422w	1250,1 2519w	1298,2 2616w	1346,2 2713w	1394,5 2810w	1442,6 2907w	1490,6 3004w	1538,8 3101w	1586,8 3198w	1634,6 3294w	1682,9 3391w	1731,1 3488w	€ W 6085

Δt autres que 50 K : consulter les Données techniques de Brem

FITTINGS \varnothing 1/2" ON REQUEST

- EG - GE with sleeve and baffle
(tapp. centres: L - 6 cm) Art. AS 91,20€
- CD - DC with baffle
(tapping centres: L+8,4 cm)
Extra Art. AS 91,20€

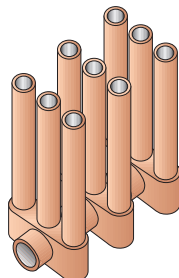

Rear metal reinforcement from 21 elements

STANDARD FITTING
 \varnothing 1/2"
AC - BD / AD - BC

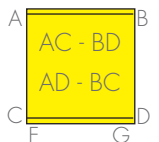

CANNUCCIA STRAW

CANNUCCIA is a funny heated towel rail inspired by the famous plastic straw used

for drinks. CANNUCCIA can be hook for dresses or towel rail and is available in

design Bettazzi+Percoco Architects three sizes, with different angles to compose various configurations in different colors.

DIMENSIONS

H = 160/175/190 cm
L = from 15 to 51 cm
P = 17/14/16 cm

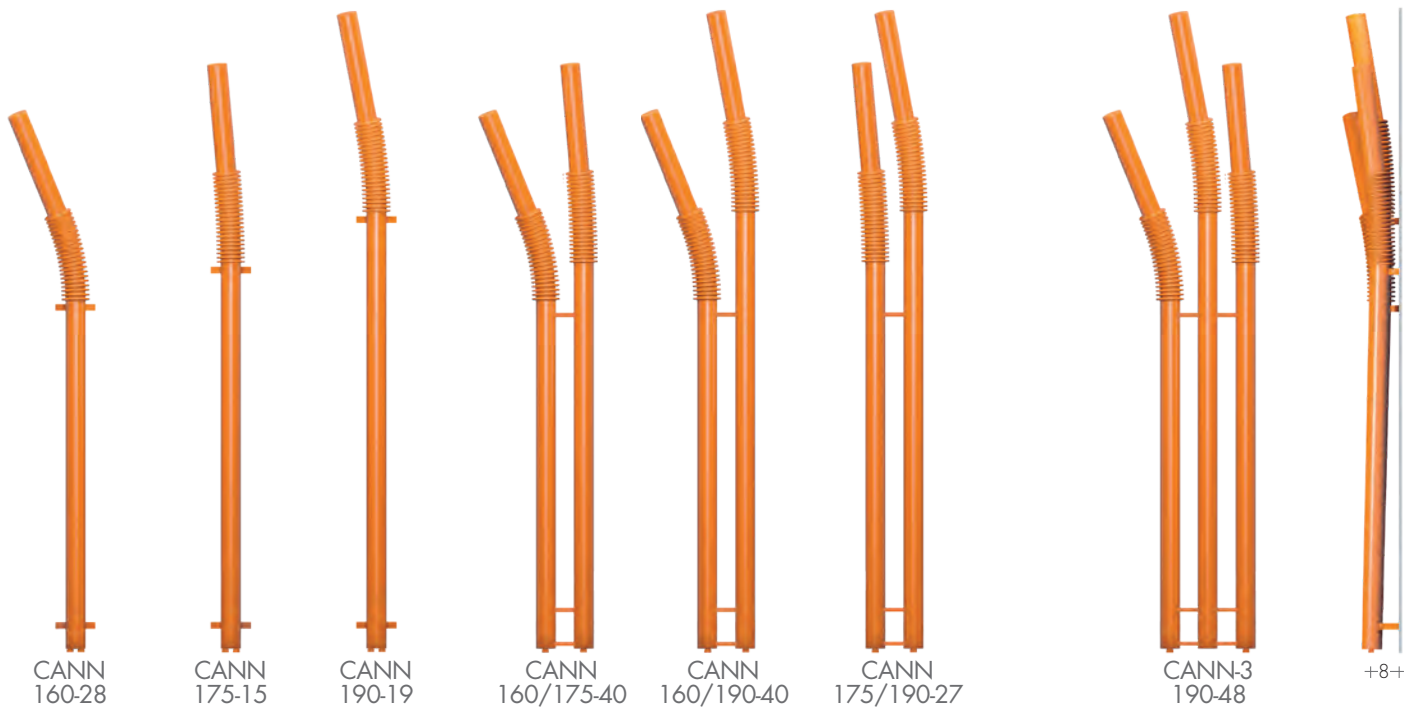

MODEL STRAW (Cannuccia)	H/L cm	Standard white sablé SB 9016 €	Δt 50K watt	EN 442 Δt 40K watt	Δt 30K watt	▲▽ t.c. cm	Height H cm	Width L cm	Weight M Kg	Volume V dm ³	DUAL FUEL VERSION with E.H.E. and* Watt €	
CANN	160-28	602,60	141	106	74	3,6	160	27,2	4,2	4,4	-	-
CANN	175-15	624,50	155	117	82	3,6	175	14,7	4,5	4,7	-	-
CANN	190-19	646,20	167	126	88	3,6	190	19,1	4,8	5,1	-	-
CANN	160/175-40	973,60	301	227	158	12	175	35,7	8,1	9,1	300	102,20
CANN	160/190-40	995,20	313	236	165	12	190	35,7	8,4	9,5	300	102,20
CANN	175/190-27	1017,00	327	247	172	12	190	23,2	8,7	9,9	400	103,40
CANN-3	190-48	1293,70	473	357	249	24	190	47,7	12,2	14,3	500	105,60
CAN-P	160/190-47	1272,40	568	429	244	19	190	42,7	16,3	11,2	650	107,80
CAN-3	190-51	1570,90	807	609	342	27	190	50,7	22,7	16,5	800	112,60

*Dual fuel valve or T to be added p.207 Thermostats p.208-209

TOWEL HOLDER MCA: STANDARD COLORS
- white sablé SB 9016 - quartz grey SB 7039
- black sablé SB 9005 - same color as the radiator

Art. MCA 30 84,60€ 30/15 cm (L/p)
Art. MCA 36 91,30€ 36/18 cm (L/p)

In one paintwork to Brem color list different from the radiator
Extra 52,90€



STANDARD PRODUCTION

White sablé SB9016 paintwork with brackets
Tolerance ± 3mm - Air vent ø 1/8"

MAXIMUM OPERATING PRESSURE 8 BAR

PRODUCTION ON REQUEST

Paintwork to BREM color list with colored brackets +15/25%

Electric version e-Cannuccia, page 213

STANDARD FITTING

EG ø 1/2"

EG ø 3/8" fittings on request



TAPPING CENTRES CANN ... MODEL

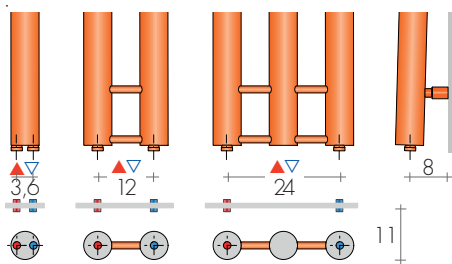

CAN-P
160/190-47

CAN-3P
190-51

CAN-P.. MODEL with radiating panel

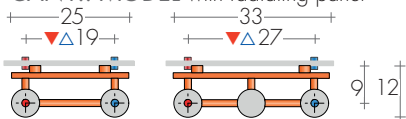

RECOMMENDED VALVES

CHROME VALVES KIT with:

- n°2 Valves with tailpieces
- n°2 Fittings (multilayer ø 16, copper ø 12, 14)
- n°2 Chrome wall plates ø 48, hole ø 16

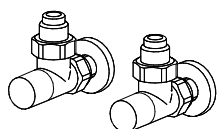

ANGLED mod. MINI VALVES KIT page 270
chrome-plated Art. KMS 124,00€

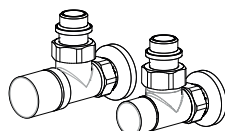

KIT ANGLED VALVES CYL with thermostatic option page 273
Art. KCS 149,90€
Extra for BREM color list 53,40€

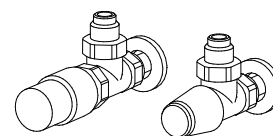

KIT ANGLED chrome VALVES mod. TON with THERMOSTATIC Head, p.269 Art. KTS190,30€



CANN 160/190-40

SPECIAL FINISHES

page 267
Finishes Gold, Bronze, Brushed Nickel for 2 valves
Brushed Nickel FITTING KIT extra Art. RN 30,50€

REMOTE FITTINGS

Art. REM 42,10€
Tapping centres: at the rear of radiator ▲▽ EG
DISTANT Valves page 274

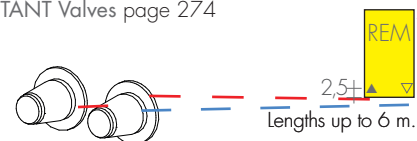

CHEM-M

design Davide Diliberto

CHEM-M is a towel holder made of 9cm diameter round tubes with the top section curved towards the wall. Available in different heights, it is completed with a

reversible towel rail and a double hook for bathrobes.

DIMENSIONS

Width: da 9 a 93cm
 Height: 96 /196 /216 /236 cm
 Depth: 18 cm
 Depth from wall: 18 cm

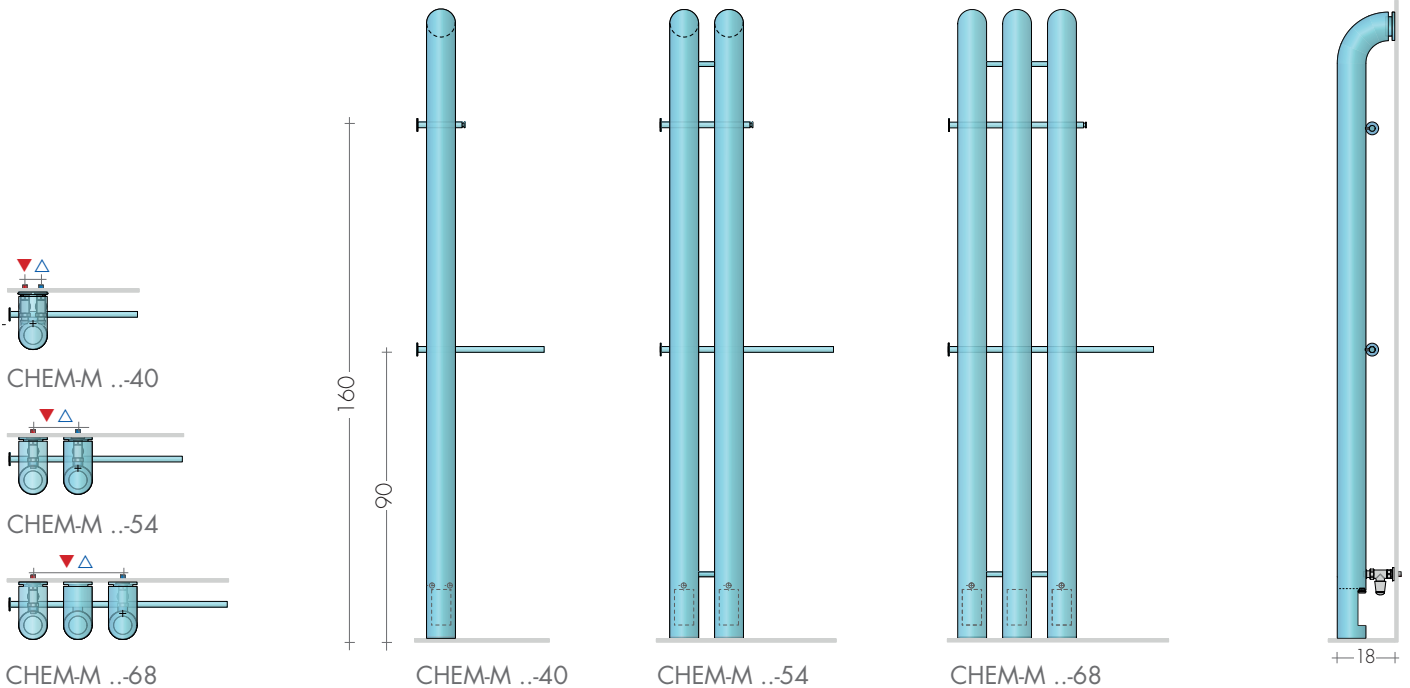

MODEL	H/L cm	Standard white sablé SB 9016 €	EN 442			▲▽ t.c. cm	Height H cm	Width L cm	Weight M Kg	Volume V dm ³	DUAL FUEL VERSION with E.H.E. * and sleeve	
			Δt 50K watt	Δt 40K watt	Δt 30K watt						Watt	€
CHEM-M	196-40	752,60	326	250	177	5	196	40	10,6	5,1	300	127,40
CHEM-M	196-54	987,80	655	502	355	5	196	54	21,0	10,2	650	129,60
CHEM-M	196-68	1229,00	984	754	533	5	196	68	31,5	15,3	900	140,20
CHEM-M	216-40	787,90	367	281	199	14	216	40	11,7	5,7	400	136,60
CHEM-M	216-54	1040,80	737	565	399	14	216	54	23,2	11,4	800	136,60
CHEM-M	216-68	1299,50	1107	848	600	14	216	68	34,8	17,1	1200	148,50
CHEM-M	236-40	823,20	408	313	221	28	236	40	12,8	6,4	400	127,40
CHEM-M	236-54	1093,70	819	627	444	28	236	54	25,4	12,8	900	140,20
CHEM-M	236-68	1370,10	1230	942	667	28	236	68	38,1	19,2	1200	148,50

On request elements with heights 206, 226. Prices and yields by interpolation.

*E.H.E. only with cable Wall-mounted thermostats p.208

Towel holder and hanger can be mounted to the left or right side.

Towel holder and hanger: STANDARD COLORS
 - white sablé SB 9016 - quartz grey SB 7039
 - black sablé SB 9005 - same color as the radiator

In one paintwork to Brem color list different from the radiator Extra 52,90€

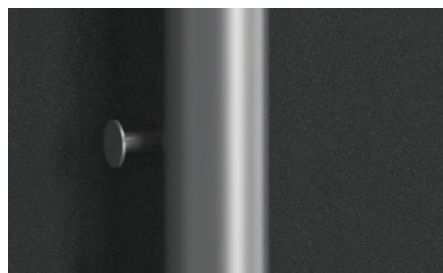

STANDARD PRODUCTION

White sablé SB9016 paintwork with brackets
 Tolerance ± 3mm - Air vent ø 1/8"
 MAXIMUM OPERATING PRESSURE 8 BAR

PRODUCTION ON REQUEST

Paintwork to Brem color list with colored brackets +15/25%
 Electric version, e.Chem-M p.214

STANDARD FITTING EG ø 1/2", on the back of the tube with straight valves.
 On request: side connections with angle valves.



TAPPING CENTRES

CHEM-M ..-40

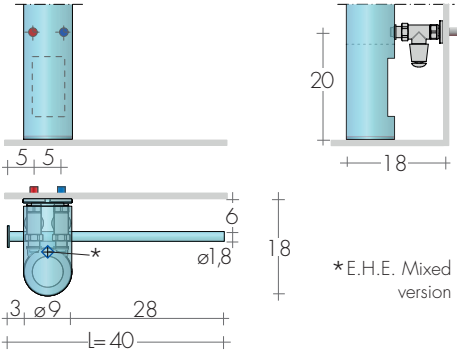

CHEM-M ..-54 / ..-68

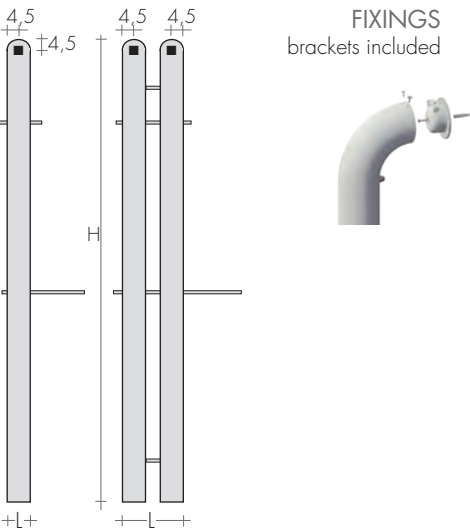
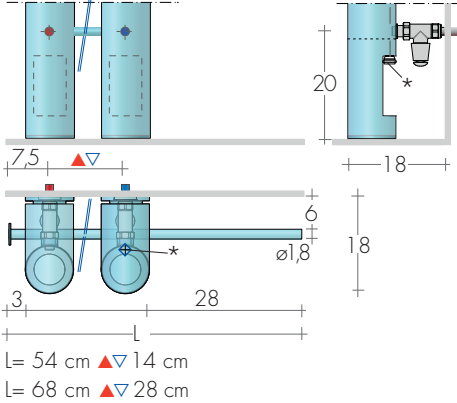

RECOMMENDED VALVES

CHROME VALVES KIT with:

- n°2 Valves with tailpieces
- n°2 Fittings (multilayer \varnothing 16, copper \varnothing 12, 14)
- n°2 Chrome wall plates \varnothing 48, hole \varnothing 16

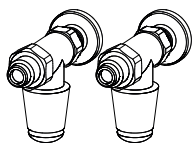

KIT STRAIGHT VALVES TON

page 269

Art. KVD 149,30€

STRAIGHT MINI VALVES KIT chrome-plated

page 270

Art. KMD 136,90€

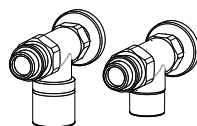

KIT STRAIGHT VALVES CYL with THERMOSTATIC

option, page.273

Art. KCD 158,80€

Extra for BREM color list

53,40€

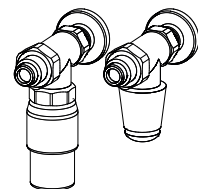

KIT STRAIGHT VALVES TON with THERMOSTATIC

Head, page 273

Art. KTD 202,40€



CHEM-M 196-40

SPECIAL FINISHES

page 267

Finishes Gold, Bronze, Brushed Nickel for 2 valves

Brushed Nickel FITTING KIT extra Art. RN 30,50€

CHEM-S

design Davide Diliberto

CHEM, the 9-cm diameter tube with the final section that curves towards the wall, also

comes in a heated towel rail version. It is produced in different models thanks to the

addition of one, two or three square tubular attached to one or two vertical elements.



DIMENSIONS

Width: 50,5 cm
Height: 216 / 216 cm
Depth: 18 cm
Depth from wall: 18 cm

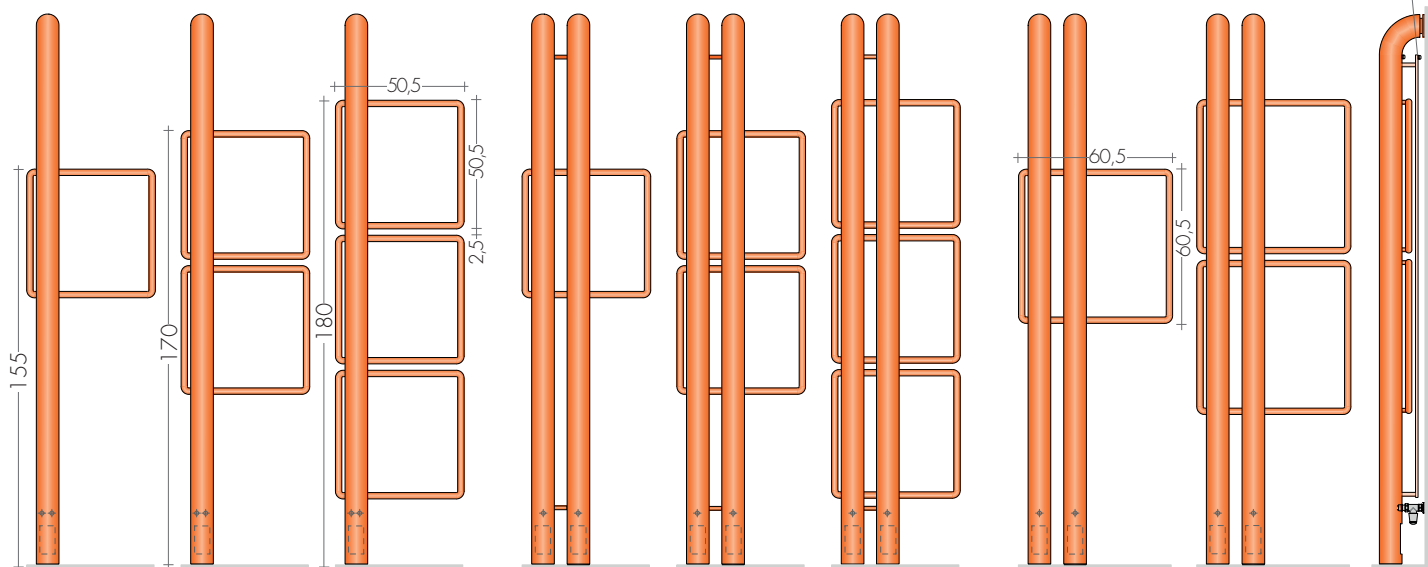
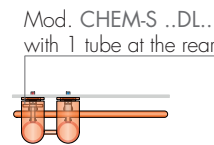
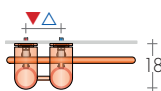
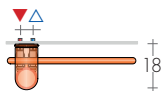

CHEM-S 196-50/1
CHEM-S 196-50/2
CHEM-S 196-50/3
CHEM-S 216-50/1
CHEM-S 216-50/2
CHEM-S 216-50/3
CHEM-S 196D-50/1
CHEM-S 196D-50/2
CHEM-S 216D-50/1
CHEM-S 196D-50/2
CHEM-S 216D-50/2
CHEM-S 196D-50/3
CHEM-S 216D-50/3
CHEM-S 196D-60/1
CHEM-S 196D-60/2
CHEM-S 216D-60/1
CHEM-S 216D-60/2
CHEM-S 216DL-60/2

MODEL	H-L cm	Standard white sablé SB 9016 €	EN 442			▲ ▽ t.c. cm	Height H cm	Width L cm	Weight M Kg	Volume V dm ³	DUAL FUEL VERSION with E.H.E.* and sleeve	
			Δt 50K watt	Δt 40K watt	Δt 30K watt						Watt	€
CHEM-S 196-50/1	196	764,40	424	325	230	5	196	50,5	12,5	5,8	400	127,40
CHEM-S 196-50/2	196	858,50	522	400	283	5	196	50,5	14,7	6,5	500	129,60
CHEM-S 196-50/3	196	952,60	620	475	336	5	196	50,5	16,9	7,2	650	131,80
CHEM-S 196D-50/1	196	999,60	753	577	408	14	196	50,5	22,8	10,9	800	136,60
CHEM-S 196D-50/2	196	1093,70	851	652	461	14	196	50,5	25,0	11,6	900	140,20
CHEM-S 196D-50/3	196	1187,80	949	727	514	14	196	50,5	27,2	12,3	900	140,20
CHEM-S 196D-60/1	196	1024,40	773	592	419	14	196	60,5	23,3	11,0	800	136,60
CHEM-S 196D-60/2	196	1134,30	891	683	483	14	196	60,5	26,0	11,8	900	140,20
CHEM-S 216-50/1	216	799,70	465	356	252	5	216	50,5	13,6	6,4	500	129,60
CHEM-S 216-50/2	216	893,80	563	431	305	5	216	50,5	15,8	7,1	500	129,60
CHEM-S 216-50/3	216	987,80	661	506	358	5	216	50,5	18,0	7,8	650	131,80
CHEM-S 216D-50/1	216	1034,90	835	640	453	14	216	50,5	25,0	12,1	800	136,60
CHEM-S 216D-50/2	216	1129,00	933	715	506	14	216	50,5	27,2	12,8	900	140,20
CHEM-S 216D-50/3	216	1223,00	1031	790	559	14	216	50,5	29,4	13,5	900	140,20
CHEM-S 216D-60/1	216	1059,60	855	655	463	14	216	60,5	25,5	12,2	800	136,60
CHEM-S 216D-60/2	216	1169,60	973	745	527	14	216	60,5	28,2	13,0	900	140,20
CHEM-S 216DL-60/2	216	1331,50	1161	889	629	14	216	60,5	31,4	14,0	1200	159,40

Square elements protruding to the left, without supplement. Custom heights on request.

*E.H.E. only with cable Wall-mounted thermostats p.208

STANDARD PRODUCTION

White sablé SB9016 paintwork brackets white
Tolerance ± 3mm - Air vent ø 1/8"
MAXIMUM OPERATING PRESSURE 8 BAR

PRODUCTION ON REQUEST

Paintwork to Brem color list with colored brackets
+15/25%
Electric version e.Chem-S, pag. 215

STANDARD FITTING

EG ø 1/2"
Only with straight valves.



TAPPING CENTRES
CHEM-S ..

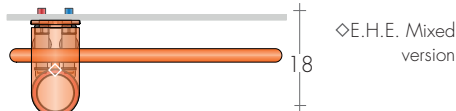
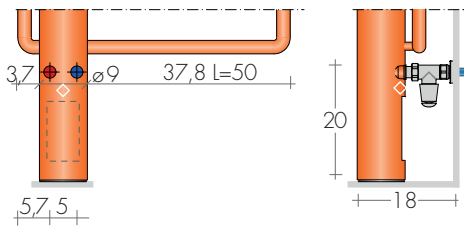

CHEM-S..D

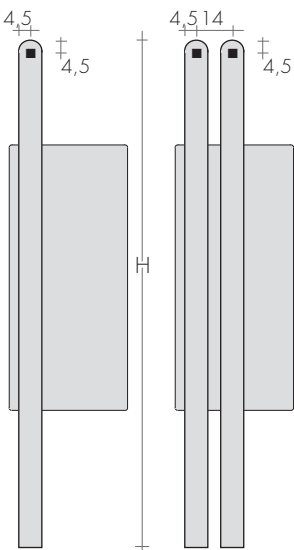
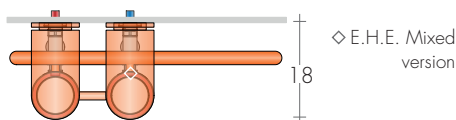
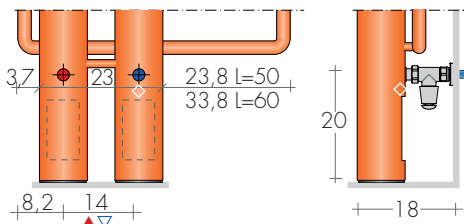

FIXINGS
brackets
included



CHEM-S 216-50/1

RECOMMENDED VALVES

CHROME VALVES KIT with:

- n°2 Valves with tailpieces
- n°2 Fittings (multilayer ø 16, copper ø 12, 14)
- n°2 Chrome wall plates ø 48, hole ø 16

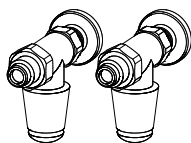

KIT STRAIGHT VALVES TON
page 269

Art. KVD 149,30€

STRAIGHT MINI VALVES KIT
chrome-plated or white color

Art. KMD 136,90€

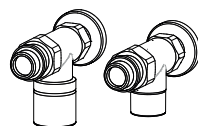

KIT STRAIGHT VALVES CYL with THERMOSTATIC
option, page.273

Art. KCD 158,80€

Extra for BREM color list

53,40€

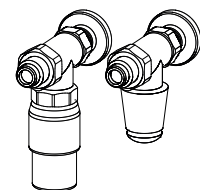

KIT STRAIGHT VALVES TON with THERMOSTATIC
Head, page 273

Art. KTD 202,40€

SPECIAL FINISHES

page 267

Finishes Gold, Bronze, Brushed Nickel for 2 valves

Brushed Nickel FITTING KIT extra Art. RN 30,50€

FRAC

design Luigi Brembilla

FRAC is the BREM heated towel rail characterized by impeccably pure lines.

The lightness given by its extremely small radiating tubes and the unique design of the

manifold that frames it make for a perfectly balanced composition.

DIMENSIONS

Width: 124/39/49/54/59 cm

Height: 44/59/69/99/129/159/189 cm

Depth: 1,8 cm

Depth from wall: 8,8 cm

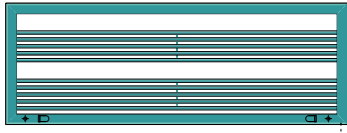

FRAC 44-124

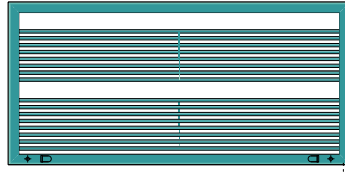

FRAC 59-124

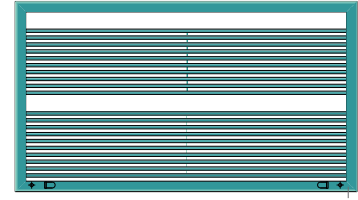

FRAC 69-124

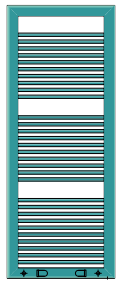
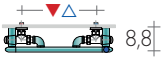

FRAC 99-..

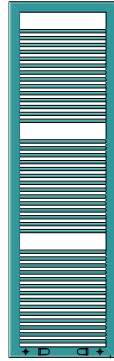

FRAC 129-..

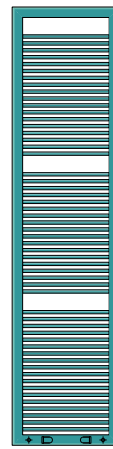

FRAC 159-..

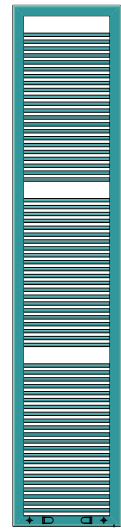

FRAC 189-..

MODEL	HL cm	Standard white sablé SB 9016 €	Δt 50 K watt	EN 442 Δt 40K watt	Δt 30 K watt	▲ ▼ t.c. cm	Height H cm	Width L cm	Weight M Kg	Volume V dm ³	DUAL FUEL VERSION with E.H.E. and sleeve	
											Watt	€
FRAC 44-124	44	623,00	477	361	252	112	44	124	6,9	2,5	500	129,60
FRAC 59-124	59	745,00	661	500	349	112	59	124	9,2	3,2	650	131,80
FRAC 69-124	69	858,50	784	593	414	112	69	124	10,7	3,6	800	136,60
FRAC 99-39	99	617,70	387	293	204	27	99	39	5,6	2,0	400	127,40
FRAC 99-49	99	639,40	471	357	249	37	99	49	6,7	2,3	500	129,60
FRAC 129-39	129	717,80	514	389	271	27	129	39	7,3	2,6	500	129,60
FRAC 129-49	129	739,90	626	474	331	37	129	49	8,7	3	650	131,80
FRAC 129-54	129	750,20	682	516	360	42	129	54	9,4	3,2	650	131,80
FRAC 159-39	159	848,60	641	485	338	27	159	39	9,1	3,2	650	131,80
FRAC 159-49	159	870,20	781	591	412	37	159	49	10,8	3,7	800	136,60
FRAC 159-54	159	902,90	846	640	447	42	159	54	11,6	3,9	900	140,20
FRAC 189-39	189	937,00	768	36	406	27	189	39	10,8	3,8	800	136,60
FRAC 189-59	189	991,40	1104	836	583	47	189	59	14,8	5,0	1200	148,50

Thermostats p.208-209

STANDARD PRODUCTION

White sablé paintwork SB9016, brackets B70
Tolerance ± 3 mm - Air vent $\varnothing 1/8"$

MAXIMUM OPERATING PRESSURE 8 BAR

PRODUCTION ON REQUEST

Paintwork to Brem color list with colored B70
brackets

Electric version e.FRAC, page 228

STANDARD FITTING

REG $\varnothing 1/2"$

with reverse valves

Fittings $\varnothing 3/8"$, on request



TAPPING CENTRES

Rear fittings for reverse valves standard

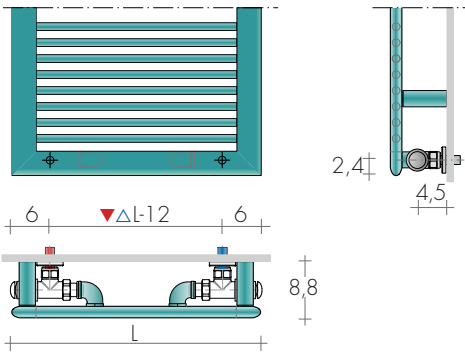

MIXED VERSION

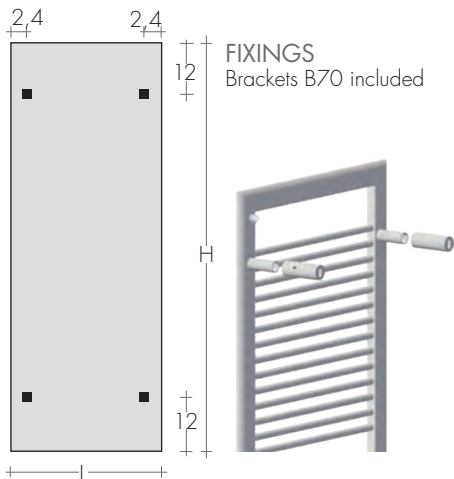
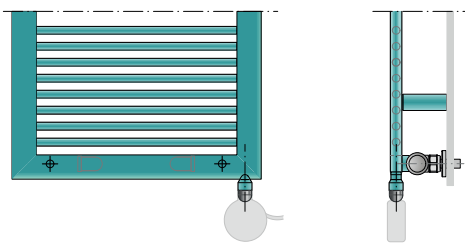

RECOMMENDED VALVES

CHROME VALVES KIT with:

- n°2 Valves with tailpieces
- n°2 Fittings (multilayer \varnothing 16, copper \varnothing 12, 14)
- n°2 Chrome wall plates \varnothing 48, hole \varnothing 16

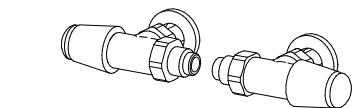

KIT REVERSE VALVES TON
page 269

Art. KVR 137,10€

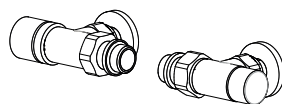

KIT REVERSE VALVES CYL with thermostatic option
page 273
Art. KCR 149,90€
Extra for BREM color list 53,40€

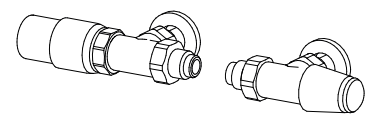

KIT REVERSE VALVES TON with THERMOSTATIC
Head page 269
Art. KTR 190,30€



FRAC 159-39

SPECIAL FINISHES

Finishes Gold, Bronze, Brushed Nickel for 2 valves
Brushed Nickel FITTING KIT extra Art. RN 30,50€

page 267

REMOTE FITTINGS

Art. REM 42,10€
Tapping centres: at the rear of radiator \blacktriangle EG L-6 cm
DISTANT Valves page 274

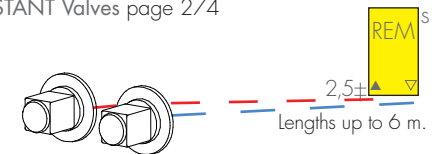

KUAD

A new sense of harmony in the bathroom: KUAD is a reversible towel-heater that can

be fitted with either the flat or the curved side of the collectors in full view.

We recommend using Quadra valves if the flat side of the collectors is visible.

DIMENSIONS

Width 35 / 45 / 50 / 55 / 60 cm
 Height 75 / 112,5 / 150 / 175 cm
 Depth 3,8 cm
 Depth from wall 10,5 cm

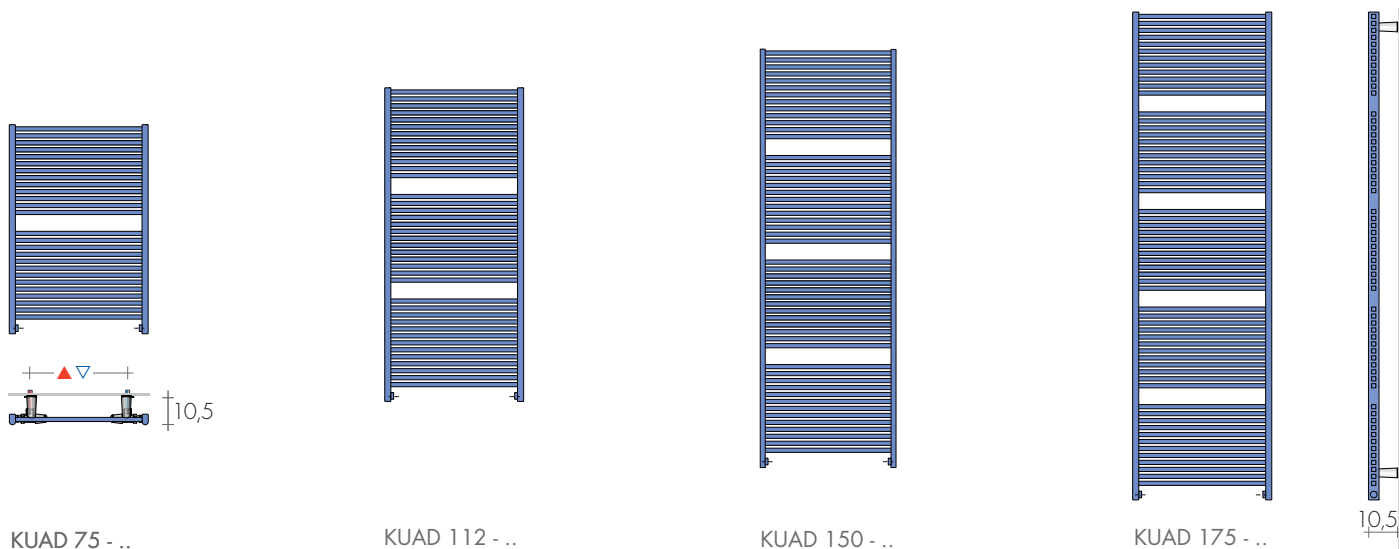

KUAD 75 - ..

KUAD 112 - ..

KUAD 150 - ..

KUAD 175 - ..

MODEL	HL cm	Standard white sablé SB 9016 €	EN 442		▲ ▽ t.c. cm	Height H cm	Width L cm	Weight M Kg	Volume V dm³	DUAL FUEL VERSION with E.H.E. and sleeve	
			Δt 50 K watt	Δt 30 K watt						Watt	€
KUAD	75-45	412,90	371	282	30,5	75	45	6,9	3,0	400	127,40
KUAD	75-50	420,30	415	315	35,5	75	50	7,4	3,2	400	127,40
KUAD	112-45	615,20	546	414	30,5	112,5	45	10,3	4,5	500	129,60
KUAD	112-50	627,20	609	462	35,5	112,5	50	11,1	4,8	650	131,80
KUAD	112-55	639,00	673	511	40,5	112,5	55	11,9	5,1	650	131,80
KUAD SLIM	150-35	752,50	553	420	20,5	150	35	13,7	5,9	500	129,60
KUAD	150-45	769,80	713	541	30,5	150	45	13,7	5,9	650	131,80
KUAD	150-50	780,90	792	601	35,5	150	50	14,8	6,4	800	136,60
KUAD	150-55	794,10	872	662	40,5	150	55	15,9	6,8	900	140,20
KUAD SLIM	175-35	849,00	643	488	20,5	175	35	13,4	5,9	650	131,80
KUAD	175-45	870,00	821	623	30,5	175	45	15,9	6,9	800	136,60
KUAD	175-50	889,60	910	691	35,5	175	50	17,2	7,4	900	140,20
KUAD	175-60	928,80	1088	826	45,5	175	60	19,7	8,4	1200	148,50

Made-to-measure versions on request

Available Stock in standard white

Thermostats p.208-209

KUAD is reversible and it can be installed with curved (C) or squared (Q) manifolds at front. As standard it has squared (Q) manifolds at front. State if the manifold front side is curved (C)

AS
STANDARD

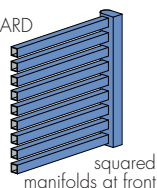

ON
REQUEST

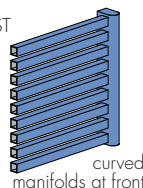

STANDARD PRODUCTION

White sablé SB9016 paintwork, M8KB brackets - Air vent ø 1/8" - Tolerance ± 3mm
 MAXIMUM OPERATING PRESSURE 8 BAR

PRODUCTION ON REQUEST

Paintwork to Brem color list with chrome-plated M8KC brackets +15/25%
 Electric version e.KUAD, page 238

STANDARD FITTING

REG ø 1/2"
 Fittings ø 3/8", on request
 KUAD as a divider, page 202

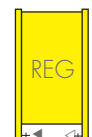

TAPPING CENTRES

Standard connection REG with reverse valves

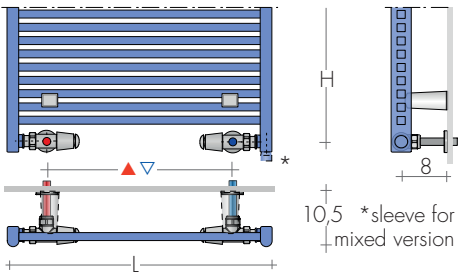

ON REQUEST
EG fittings

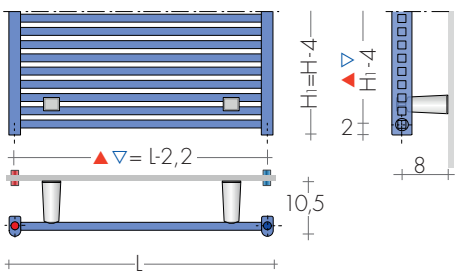

Height is 4 cm less (H1) for:
- EG fitting (t.c. L-2,2cm)
- side fittings (t.c. H1-4cm)

Extra Art. AS 91,20€

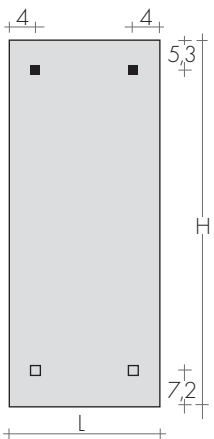

FIXINGS
Brackets included



Art. M8K..

□ Mod. h 180cm



KUAD 75-50

RECOMMENDED VALVES

CHROME VALVES KIT with:

- n°2 Valves with tailpieces
- n°2 Fittings (multilayer ø 16, copper ø 12, 14)
- n°2 Chrome wall plates ø 48, hole ø 16

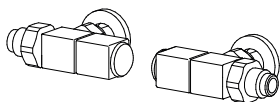

KIT REVERSE VALVES QUADRA
page 271 Art. KQR 180,10€
Extra for BREM color list 53,40€

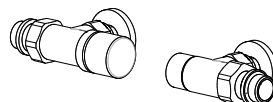

KIT REVERSE VALVES CYL with thermostatic option
page 273 Art. KCR 149,90€
Extra for BREM color list 53,40€



Lengths up to 6 m.

SPECIAL FINISHES page 267
Finishes Gold, Bronze, Brushed Nickel for 2 valves
Brushed Nickel FITTING KIT extra Art. RN 30,50€

REMOTE FITTINGS Art. REM 42,10€
Tapping centres: at the rear of radiator ▲▽ L-2cm
DISTANT Valves page 274

KIT REVERSE VALVES TON with THERMOSTATIC
Head page 269 Art. KTR 190,30€

MAHN

The high thermal output and much reduced protrusion of the round tubes with curved

corners are the main characteristics of the MAHN heated towel rail. The beauty of

radiators using thin tubes is highlighted by the absence of sharp corners.

DIMENSIONS

Width 28/50/60/75 cm

Height 68,3/89,3/116,8/144,3/177,3 cm

Depth 6,5 cm

Depth from wall 9,5 cm

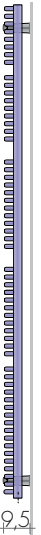
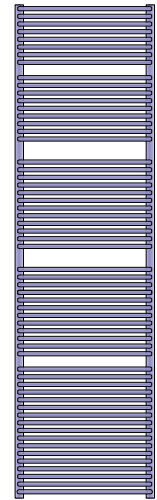
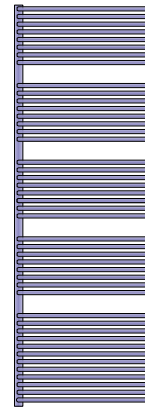
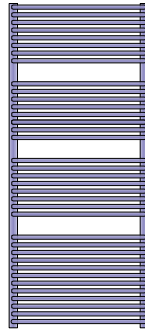
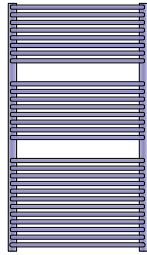
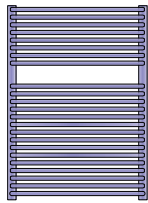

MAHN 70 - 50

MAHN 90 - 50

MAHN 120 - 50

MAHN 150 - ...

MAHN 180 - ...

MODEL	HxL cm	Standard white sablé SB 9016 €	Δt 50K watt	EN 442 Δt 40K watt	Δt 30K watt	▲ ▼ t.c. cm	Height H cm	Width L cm	Weight M Kg	Volume V dm³	DUAL FUEL VERSION with E.H.E. and* Watt €	
											Watt	€
MAHN	70-50	584,00	420	317	220	47	68,3	50	5,5	3,31	400	103,40
MAHN	90-50	742,70	549	414	287	47	89,3	50	7,0	4,22	500	105,60
MAHN	120-50	883,60	684	516	358	47	116,8	50	9,0	5,47	650	107,80
Slim-MAHN	150-28	955,60	541	408	283	25	144,3	28	7,5	5,21	500	105,60
MAHN	150-50	1047,30	833	629	436	47	144,3	50	11	6,73	800	112,60
MAHN	150-60	1098,00	986	744	516	57	144,3	60	12,6	7,31	900	116,20
Slim-MAHN	180-28	1135,30	683	516	357	25	177,3	28	9,7	6,76	650	107,80
MAHN	180-50	1238,70	1056	797	552	47	177,3	50	13,9	8,40	1200	124,50
MAHN	180-60	1302,20	1226	926	641	57	177,3	60	15,8	9,14	1200	124,50
MAHN	180-75	1408,50	1562	1179	817	72	177,3	75	18,7	10,25	1500	135,40
MAHN-PLUS	150-50	1797,70	1604	1211	842	47	144,3	50	20,5	13,20	1500	135,40
CHROME-PLATED VERSION												
M-CROM	70-50	1178,10	336	254	176	47	68,3	50	5,5	3,31	300	102,30
M-CROM	90-50	1501,50	439	331	229	47	89,3	50	7,0	4,22	400	103,40
M-CROM	120-50	1785,20	547	413	286	47	116,8	50	9,0	5,47	500	105,60
M-CROM	150-50	2115,50	666	502	349	47	144,3	50	11	6,73	650	107,80
M-CROM	180-28	2288,30	546	411	285	25	177,3	28	9,7	6,76	500	105,60
M-CROM	180-50	2502,50	845	638	442	47	177,3	50	13,9	8,40	900	116,20

Chrome plated finish with chrome-plated brackets

*Dual fuel valve or T to be added p.207
Thermostats p.208-209

STANDARD PRODUCTION

White sablé SB9016 paintwork, M8B brackets
Air vent ø 1/8" - Tolerance ± 3mm

MAXIMUM OPERATING PRESSURE 8 BAR

PRODUCTION ON REQUEST

Paintwork to Brem color list with chrome-plated M8C brackets +15/25%

Electrical version e.Mahn, page 244

STANDARD FITTING

EG ø 1/2"

Fittings on request, page 279

Accessories, page 277

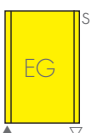

TAPPING CENTRES

EG vertical standard fittings
Side fittings, on request

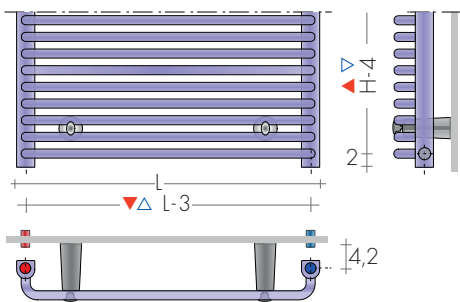

Side fittings (▲▽: H-4cm)

Extra

Art. AS 91,20€

MAHN PLUS EG fittings ø 1/2"

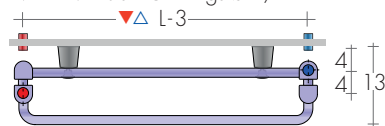

left front delivery, right rear return

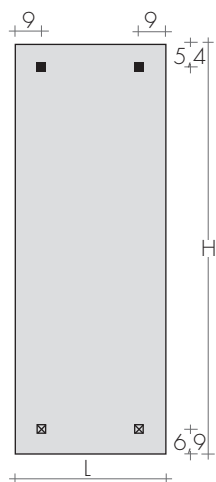

FIXINGS

Brackets included



Art. M8..
MAHN PLUS
Art. M4..

MAHN h 180 cm



M-CROM 90-50

RECOMMENDED VALVES

CHROME VALVES KIT with:

- n°2 Valves with tailpieces
- n°2 Fittings (multilayer ø 16, copper ø 12, 14)
- n°2 Chrome wall plates ø 48, hole ø 16

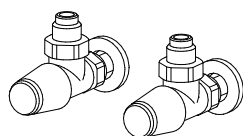

KIT ANGLED VALVES TON
page 269

Art. KVS 137,10€

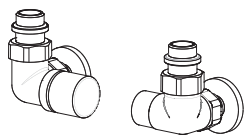

KIT SIDE control VALVES CYL with THERMOSTATIC
option, page 273
Art. KCL 162,50€
Extra for BREM color list 53,40€



SPECIAL FINISHES page 267
Finishes Gold, Bronze, Brushed Nickel for 2 valves
Brushed Nickel FITTING KIT extra Art. RN 30,50€

REMOTE FITTINGS Art. REM 42,10€
Tapping centres: at the rear of radiator ▲▽ EG
DISTANT Valves page 274

KIT SIDE control VALVES TON with Thermostatic
Head, page 269 Art. KTL 203,70€

MAHN-AIR

The harmony of rhythms and alternations of round tubes with curved corners and spaces,

give shape to a collection of very practical towel warmers with a simple and attractive

design suitable for installation from the living area bathroom to the master bathroom.

DIMENSIONS

Width 51/61/75 cm

Height 82/111/112/142/155/172/180/186 cm

Depth 6,5 cm Depth from wall 10 cm



MAHN-AIR 82-51



MAHN-AIR 112-51



MAHN-AIR 142-51

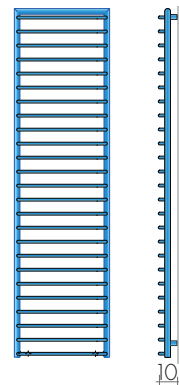

MAHN-AIR 186-51

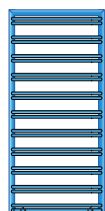

MAHN-A2R 111-51

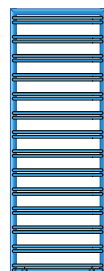

MAHN-A2R 142-51

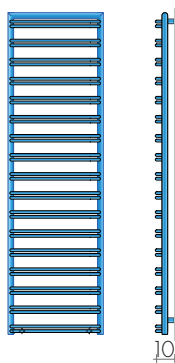

MAHN-A2R 172-51

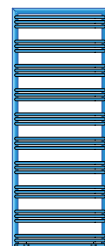

MAHN-A3R 128-51

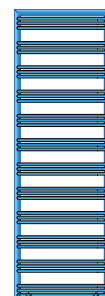

MAHN-A3R 155-51

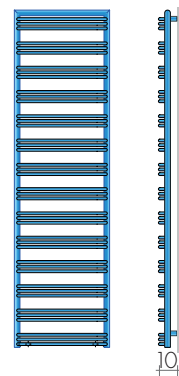

MAHN-A3R 180-51

MODELE	H/L cm	Standard white sablé SB 9016 €	EN 442			▲ ▽ t.c. cm	Height H cm	Width L cm	Weight M Kg	Volume V dm ³	DUAL FUEL VERSION with E.H.E. and sleeve	
			Δt 50K watt	Δt 40K watt	Δt 30K watt						Watt	€
MAHN-AIR	82-51	525,50	294	221	154	36	81,5	51	4,0	1,8	300	126,20
MAHN-AIR	112-51	594,20	393	296	206	36	111,5	51	5,5	2,5	400	127,40
MAHN-AIR	142-51	751,00	491	370	257	36	141,5	51	6,9	3,2	500	129,60
MAHN-AIR	186-51	867,10	638	480	334	36	186,5	51	9,1	4,2	650	131,80
MAHN-AIR	186-61	911,60	716	539	374	46	186,5	61	10,0	4,5	650	131,80
MAHN-A2R	111-51	705,50	503	379	263	36	111	51	6,7	3	500	129,60
MAHN-A2R	142-51	839,30	633	477	331	36	141,6	51	8,6	3,8	650	131,80
MAHN-A2R	172-51	929,00	764	575	400	36	172,2	51	10,4	4,7	800	136,60
MAHN-A2R	172-61	976,60	868	654	454	46	172,2	61	11,6	5,1	900	140,20
MAHN-A3R	128-51	861,80	650	489	340	36	128,5	51	8,7	3,8	650	131,80
MAHN-A3R	155-51	942,50	775	584	405	36	154,5	51	10,4	4,6	800	136,60
MAHN-A3R	180-51	1012,70	900	678	471	36	180,5	51	12,1	5,4	900	140,20
MAHN-A3R	180-61	1166,70	1027	773	537	46	180,5	61	13,6	5,9	-	-

Thermostats p.208-209

STANDARD PRODUCTION

White sablé SB9016 paintwork, B35 brackets

Air vent ø 1/8" - Tolerance ± 3mm

MAXIMUM OPERATING PRESSURE 8 BAR

PRODUCTION ON REQUEST

Paintwork to Brem color list with colored B35 brackets

Electric version e.Mahn-AIR, page 245

STANDARD FITTING

REG ø 1/2"

Fittings ø 3/8", on request

Fittings on request, page 279

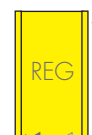

TAPPING CENTRES

Standard connection REG with reverse valves

MAHN-AIR

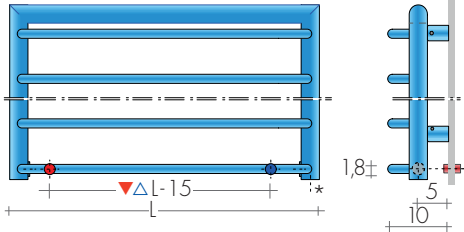

MAHN-A2R

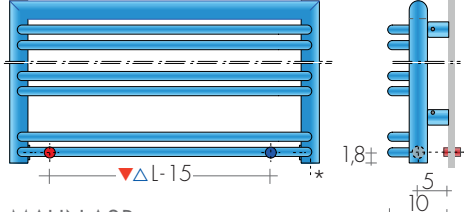

MAHN-A3R

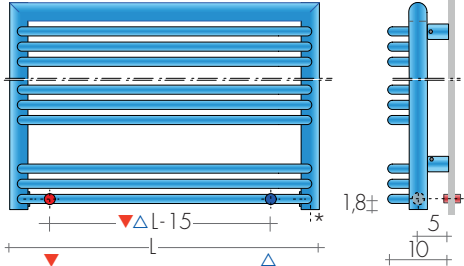

*E.H.E
mixed version

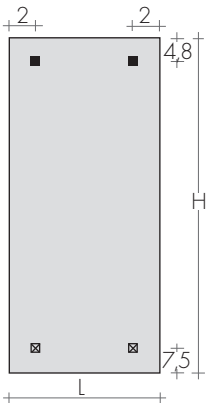

FIXINGS
Brackets B35 included



MAHN-AIR 142-51

MAHN-A2R 142-51

MAHN-A3R 155-51

RECOMMENDED VALVES

CHROME VALVES KIT with:

- n°2 Valves with tailpieces
- n°2 Fittings (multilayer ø 16, copper ø 12, 14)
- n°2 Chrome wall plates ø 48, hole ø 16

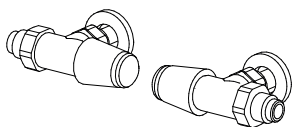

KIT REVERSE VALVES TON
page 269

Art. KVR 137,10€

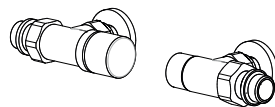

KIT REVERSE VALVES CYL with thermostatic option
page 273
Art. KCR 149,90€
Extra for BREM color list 53,40€



REMOTE FITTINGS Art. REM 42,10€
Tapping centres: at the rear of radiator ▲▽ L-3cm
DISTANT Valves page 274

KIT REVERSE VALVES TON with THERMOSTATIC
Head page 269 Art. KTR 190,30€

PLANK

PLANK is a modern design towel rail warmer with 20 x 20 mm square tubes and

round manifolds. Suitable for any setting and available in different heights and

widths, can satisfy any request of heating performance for your bathroom

DIMENSIONS

Width: 40/50/60/120 cm

Height: 44/52/88/124/172/180 cm

Depth: 5 cm

Depth from wall: 8 cm

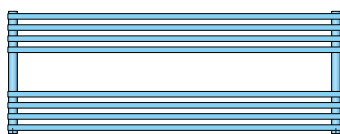

PLANK 45 - 120



PLANK 50 - 120

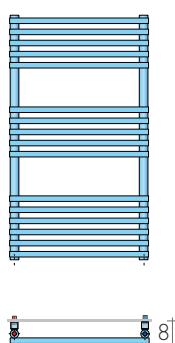

PLANK 90 - ..

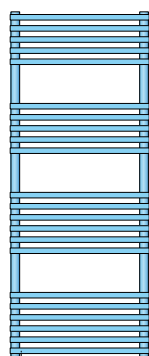

PLANK 125 - ..

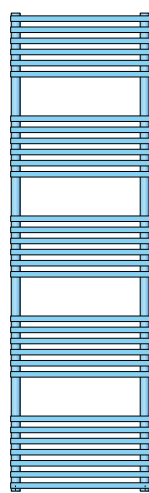

PLANK 170 - ..

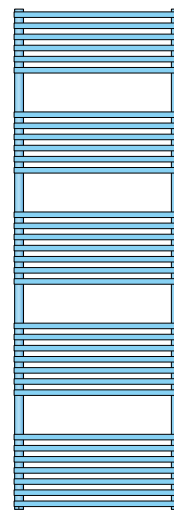

PLANK 180 - 60

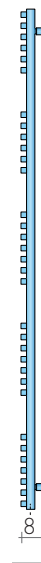

MODEL	H-L cm	Standard white sablé SB 9016 €	EN 442			▲ ▼ t.c. cm	Height H cm	Width L cm	Weight M Kg	Volume V dm ³	DUAL FUEL VERSION with E.H.E. and*	
			Δt 50K watt	Δt 40K watt	Δt 30K watt						Watt	€
PLANK	45-120	460,10	489	369	257	117	44	120	8,4	3,5	-	-
PLANK	50-120	497,10	608	459	320	117	52	120	10,5	4,4	-	-
PLANK	90-40	365,80	▶ 390	294	205	37	88	40	7,0	3,1	400	103,40
PLANK	90-50	379,70	▶ 463	350	244	47	88	50	8,2	3,6	500	105,60
PLANK	125-40	489,40	▶ 539	407	284	37	124	40	9,6	4,3	500	105,60
PLANK	125-50	506,40	▶ 640	483	337	47	124	50	11,4	5,0	650	107,80
PLANK	125-60	523,20	741	559	390	57	124	60	13,1	5,7	800	112,60
PLANK	170-40	669,80	▶ 757	572	398	37	172	40	13,5	6,0	800	112,60
PLANK	170-50	696,20	▶ 899	679	473	47	172	50	15,9	7,0	900	116,20
PLANK	180-60	763,70	1110	838	584	57	180	60	19,4	8,4	1200	124,50

▶ Available Stock in standard white

*Dual fuel valve or T to be added p.207
Thermostats p.208-209

STANDARD PRODUCTION

White sablé SB9016 paintwork, G30 brackets
Tolerance ± 3 mm - Air vent ø 1/2"

MAXIMUM OPERATING PRESSURE 8 BAR

PRODUCTION ON REQUEST

Paint to Brem color list with G30 colored
brackets +15/25%

Electric version e.PLANK, page 249

STANDARD FITTINGS

EG ø 1/2"



TAPPING CENTRES

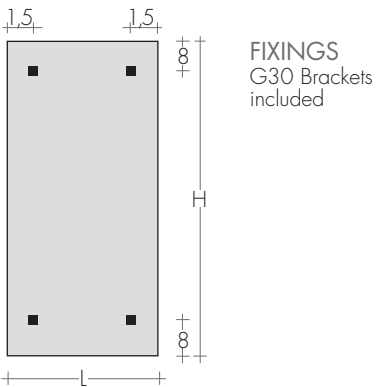
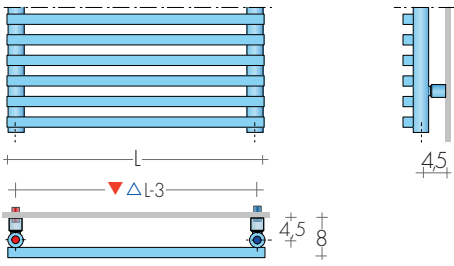

RECOMMENDED VALVES

CHROME VALVES KIT with:

- n°2 Valves with tailpieces
- n°2 Fittings (multilayer ø 16, copper ø 12, 14)
- n°2 Chrome wall plates ø 48, hole ø 16

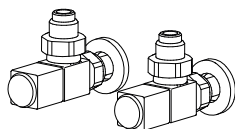

ANGLED QUADRA VALVES KIT
page 271 Art. KQS 180,10€
Extra for BREM color list 53,40€

SPECIAL FINISHES

page 267
Finishes Gold, Bronze, Brushed Nickel for 2 valves
Brushed Nickel FITTING KIT extra Art. RN 30,50€

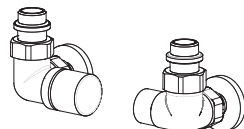

KIT SIDE control VALVES CYL with THERMOSTATIC
option, page 273 Art. KCL 162,50€
Extra for BREM color list 53,40€

REMOTE FITTINGS

Art. REM 42,10€
Tapping centres: at the rear of radiator ▲ ▼ EG
DISTANT Valves page 274

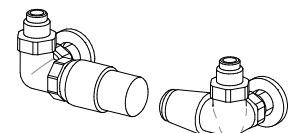
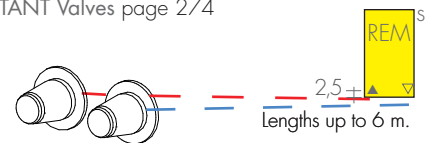

KIT SIDE control VALVES TON with Thermostatic
Head, page 269 Art. KTL 203,70€

PLANK-AIR

PLANK-AIR is a modern design towel rail warmer with 20 x 20 mm square tubes and

round manifolds. Suitable for any setting and available in five heights and four

widths, can satisfy any request of heating performance for your bathroom

DIMENSIONS

Width: 40/50/60/120 cm

Height: 44/60/92/116/156/180 cm

Depth: 5 cm

Depth from wall: 8 cm



PLANK-AIR 44 - 120



PLANK-AIR 60 - 120

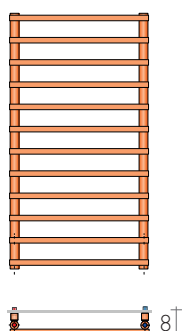

PLANK-AIR 92 - ..

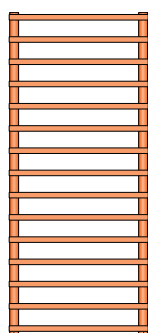

PLANK-AIR 116 - ..

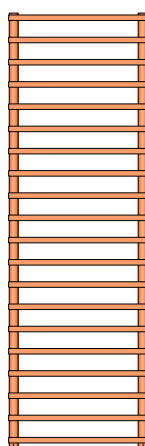

PLANK-AIR 156 - ..

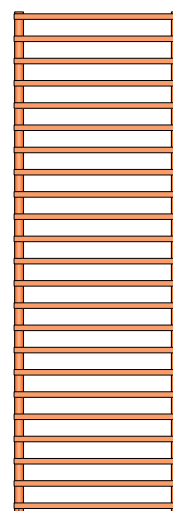

PLANK-AIR 180 - 60

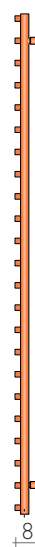

MODEL	H-L cm	Standard white sablé SB 9016 €	EN 442			▲▼ t.c. cm	Height H cm	Width L cm	Weight M Kg	Volume V dm ³	DUAL FUEL VERSION with E.H.E. and* Watt €	
			Δt50K watt	Δt40K watt	Δt30K watt							
PLANK-AIR	44-120	416,10	379	286	199	117	44	120	6,6	2,8	-	-
PLANK-AIR	60-120	474,50	507	383	267	117	60	120	8,8	3,7	-	-
PLANK-AIR	92-40	329,20	321	242	169	37	92	40	5,8	2,7	300	102,20
PLANK-AIR	92-50	352,90	376	284	198	47	92	50	6,7	3,0	400	103,40
PLANK-AIR	116-40	401,30	402	304	211	37	116	40	7,3	3,3	400	103,40
PLANK-AIR	116-50	446,10	471	356	248	47	116	50	8,5	3,8	500	105,60
PLANK-AIR	156-40	496,50	537	405	282	37	156	40	9,8	4,5	500	105,60
PLANK-AIR	156-50	528,40	629	475	331	47	156	50	11,3	5,1	650	107,80
PLANK-AIR	156-60	559,40	721	544	379	57	156	60	12,9	5,7	800	112,60
PLANK-AIR	180-40	591,80	618	467	325	37	180	40	11,2	5,1	650	107,80
PLANK-AIR	180-50	610,80	724	547	381	47	180	50	13,0	5,9	800	112,60
PLANK-AIR	180-60	649,20	830	627	437	57	180	60	14,8	6,6	900	116,20

*Dual fuel valve or T to be added p.207
Thermostats p.208-209

STANDARD PRODUCTION

White sablé SB9016 paintwork, G30 brackets, tolerance ± 3 mm - Air vent ø 1/2"

MAXIMUM OPERATING PRESSURE 8 BAR

PRODUCTION ON REQUEST

Paint to Brem color list with G30 colored brackets +15/25%

Electric version e.PLANK-AIR, page 249

STANDARD FITTINGS

EG ø 1/2"



TAPPING CENTRES

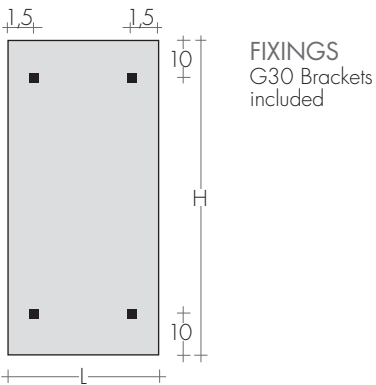
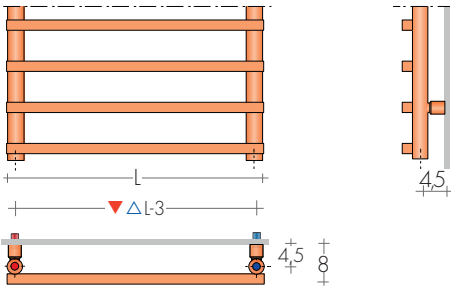

FIXINGS
G30 Brackets
included



PLANK-AIR 156-50

RECOMMENDED VALVES

CHROME VALVES KIT with:

- n°2 Valves with tailpieces
- n°2 Fittings (multilayer ø 16, copper ø 12, 14)
- n°2 Chrome wall plates ø 48, hole ø 16

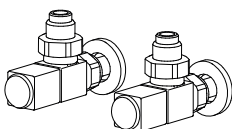

ANGLED QUADRA VALVES KIT
page 271 Art. KQS 180,10€
Extra for BREM color list 53,40€

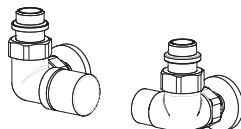

KIT SIDE control VALVES CYL with THERMOSTATIC
option, page 273 Art. KCL 162,50€
Extra for BREM color list 53,40€



SPECIAL FINISHES page 267
Finishes Gold, Bronze, Brushed Nickel for 2 valves
Brushed Nickel FITTING KIT extra Art. RN 30,50€

REMOTE FITTINGS Art. REM 42,10€
Tapping centres: at the rear of radiator ▲▼ EG
DISTANT Valves page 274

KIT SIDE control VALVES TON with Thermostatic
Head, page 269 Art. KTL 203,70€

PLUS 12

The PLUS 12 towel warmer is produced with thin $\varnothing 12$ tubes that emit very high yields.

The manifolds, with their round tubes, are extremely compact to minimise space.

The PLUS 12 comes in all the shades in the Brem colour list.

DIMENSIONS

Widths: 40/50/60/75 cm
 Heights: 85/115/145/175 cm
 Depth: 4 cm
 Depth from wall: 9 cm

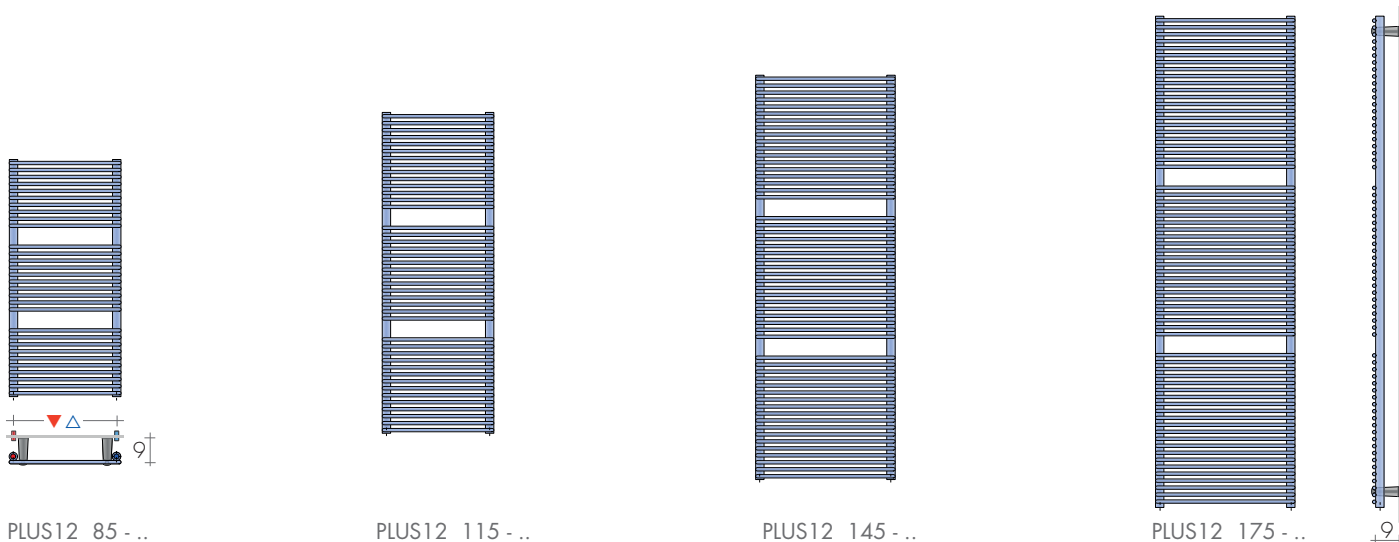

PLUS12 85 - ..

PLUS12 115 - ..

PLUS12 145 - ..

PLUS12 175 - ..

MODEL	HxL cm	Standard white sablé SB9016 €	EN 442			▲▽ t.c. cm	Height H cm	Width L cm	Weight M Kg	Volume V dm ³	DUAL FUEL VERSION with E.H.E. and* Watt €	
			Δt 50K watt	Δt 40K watt	Δt 30K watt						Watt	€
PLUS 12	85-40	394,10	382	291	205	37	85	40	5	1,9	400	103,40
PLUS 12	85-50	401,50	455	347	244	47	85	50	5,8	2,2	500	105,60
PLUS 12	115-40	560,60	531	405	285	37	115	40	7,0	2,6	500	105,60
PLUS 12	115-50	576,90	633	482	339	47	115	50	8,1	3,0	650	107,80
PLUS 12	145-40	642,50	679	517	364	37	145	40	8,9	3,4	650	107,80
PLUS 12	145-50	662,60	812	619	435	47	145	50	10,3	3,8	800	112,60
PLUS 12	145-60	687,70	944	719	506	57	145	60	11,8	4,2	900	116,20
PLUS 12	175-40	734,40	828	631	444	37	175	40	10,8	4,1	800	112,60
PLUS 12	175-50	768,90	990	754	531	47	175	50	12,6	4,6	900	116,20
PLUS 12	175-60	788,50	1151	877	617	57	175	60	14,4	5,1	1200	124,50
PLUS 12	175-75	892,20	1394	1062	747	72	175	75	17,0	5,9	1500	135,40

► Available Stock in standard white

*Dual fuel valve or T to be added p.207
 Thermostats p.208-209

STANDARD PRODUCTION

White sablé SB9016 paintwork, M8GB
 brackets, Tolerance ± 3 mm - Air vent $\varnothing 1/8"$
 MAXIMUM OPERATING PRESSURE 6 BAR

PRODUCTION ON REQUEST

Paint to Brem color list with
 chrome-plated brackets M8GC +15/25%
 Electric version e.Plus12, page 251

STANDARD FITTINGS

EG $\varnothing 1/2"$

Accessories, page 277



TAPPING CENTRES

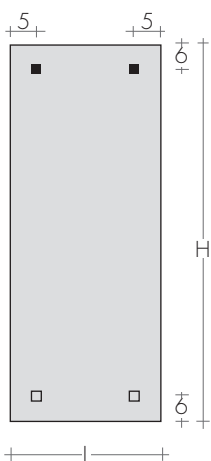
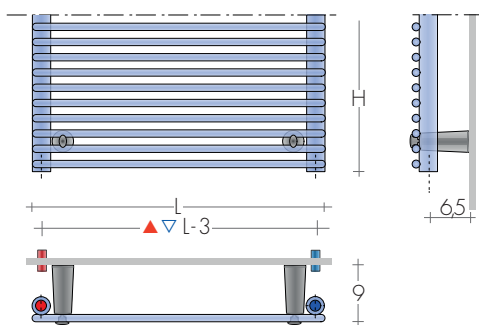

FIXINGS
Brackets included



Art. M8G..

□ Mod. h 175cm

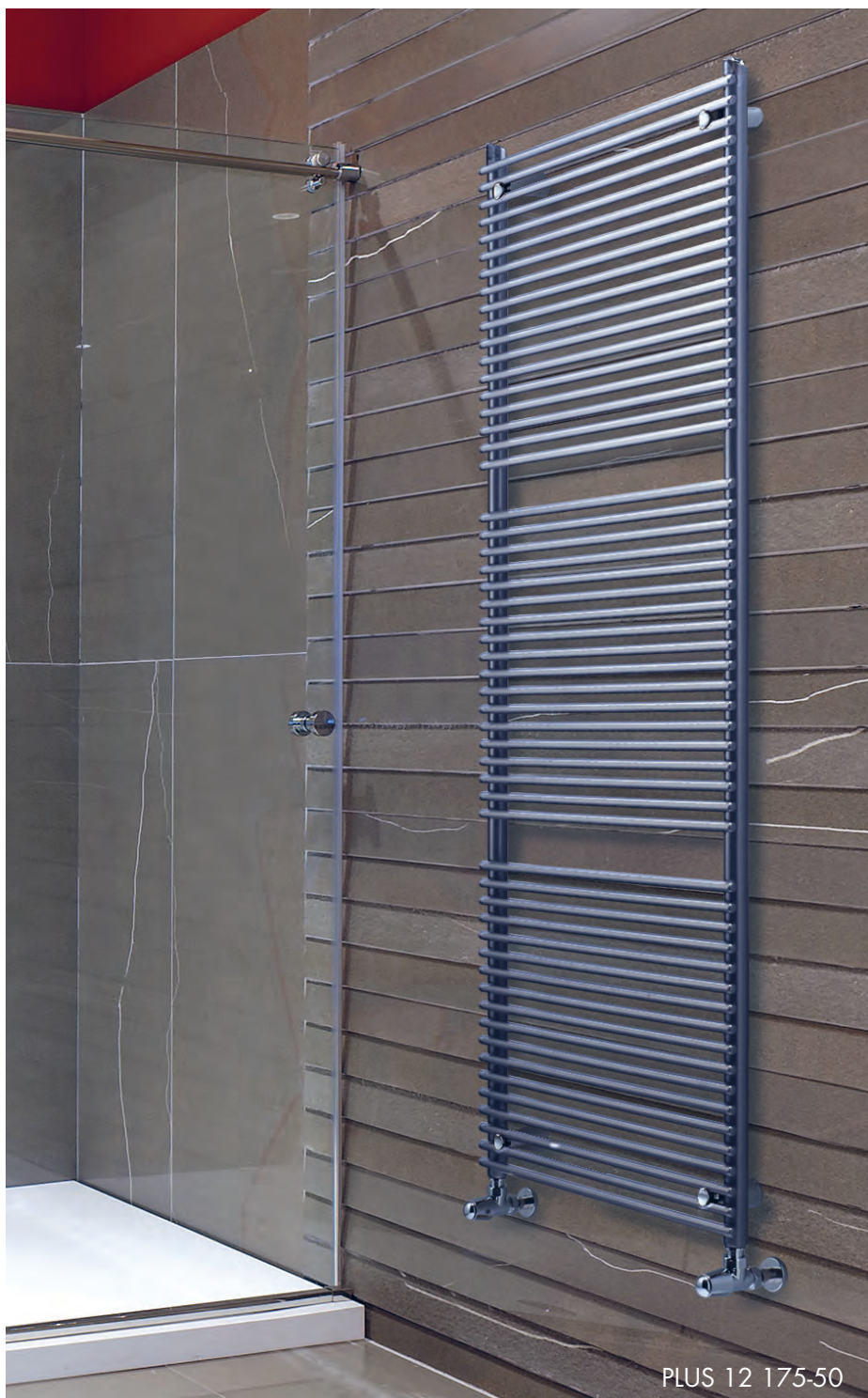

PLUS 12 175-50

RECOMMENDED VALVES

CHROME VALVES KIT with:

- n°2 Valves with tailpieces
- n°2 Fittings (multilayer ø 16, copper ø 12, 14)
- n°2 Chrome wall plates ø 48, hole ø 16

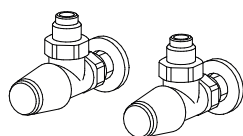

KIT ANGLED VALVES TON
page 269

Art. KVS 137,10€

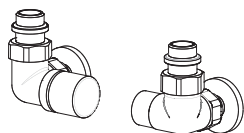

KIT SIDE control VALVES CYL with THERMOSTATIC
option, page 273
Art. KCL 162,50€
Extra for BREM color list 53,40€



SPECIAL FINISHES page 267
Finishes Gold, Bronze, Brushed Nickel for 2 valves
Brushed Nickel FITTING KIT extra Art. RN 30,50€

REMOTE FITTINGS Art. REM 42,10€
Tapping centres: at the rear of radiator ▲▼ EG
DISTANT Valves page 274

KIT SIDE control VALVES TON with Thermostatic
Head, page 269 Art. KTL 203,70€

PLUS 18

Towel warmer with a classic design suitable for installation in any bathroom.

Made with vertical manifolds and round horizontal tubes is available in six heights

and four widths. The radiant tubes have the terminals with an exclusive spherical shape.

DIMENSIONS

Width 42/52/62 cm

Height 79,2/122,4/158,4/180 cm

Depth 4,7 cm

Depth from wall 8,9 cm

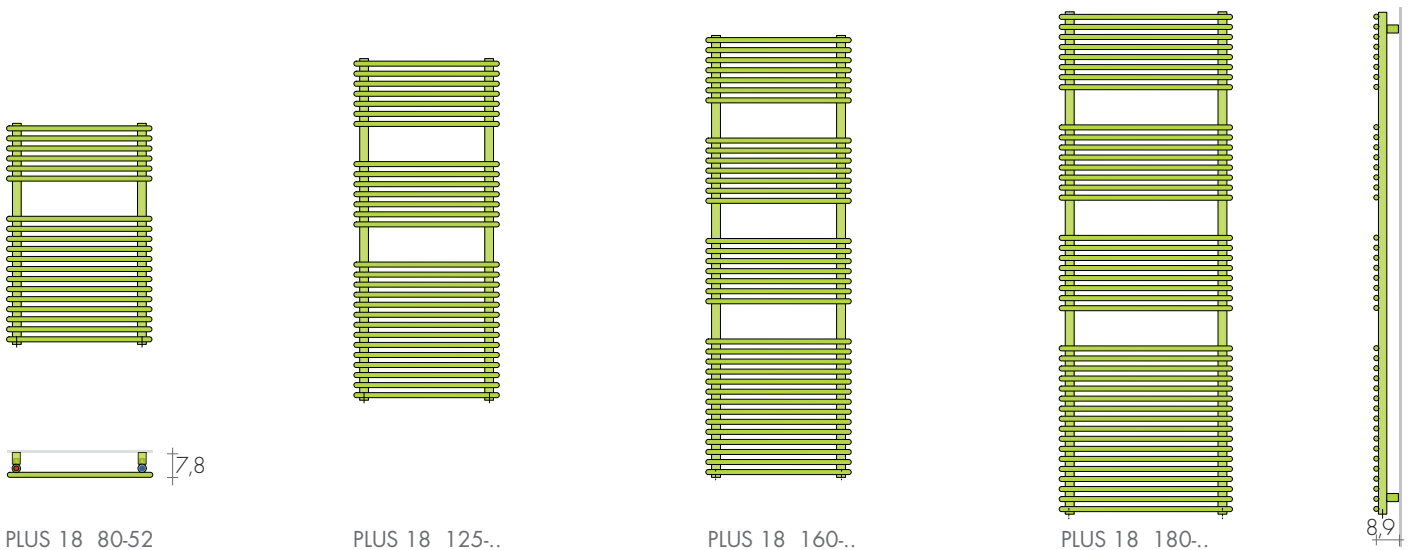

PLUS 18 80-52

PLUS 18 125-..

PLUS 18 160-..

PLUS 18 180-..

MODEL	H-L cm	Standard white sablé SB9016 €	EN 442			▲ ▽ t.c. cm	Height H cm	Width L cm	Weight M Kg	Volume V dm ³	DUAL FUEL VERSION with E.H.E. and* Watt €	
			Δt 50 K watt	Δt 40 K watt	Δt 30 K watt						Watt	€
PLUS 18	80-52	302,40	408	310	217	45	79,2	52	7,2	2,9	400	103,40
PLUS 18	125-42	379,70	516	392	275	35	122,4	42	9,2	3,8	500	105,60
PLUS 18	125-52	393,80	607	462	324	45	122,4	52	10,7	4,3	650	107,80
PLUS 18	160-42	457,10	650	494	346	35	158,4	42	11,6	4,8	650	107,80
PLUS 18	160-52	478,10	764	581	407	45	158,4	52	13,5	5,5	800	112,60
PLUS 18	160-62	500,60	878	668	468	55	158,4	62	15,5	6,2	900	116,20
PLUS 18	180-42	538,60	756	575	403	35	180	42	13,5	5,6	800	112,60
PLUS 18	180-52	562,60	889	676	474	45	180	52	15,7	6,4	900	116,20
PLUS 18	180-62	586,50	1022	777	545	55	180	62	18,0	7,2	1200	124,50

▶ Available Stock in standard white

*Dual fuel valve or T to be added p.207
Thermostats p.208-209

STANDARD PRODUCTION

White sablé SB9016 paintwork - white G40 brackets; Tolerance ± 3 mm - Air vent ø 1/2"

MAXIMUM OPERATING PRESSURE 8 BAR

PRODUCTION ON REQUEST

Paint to Brem color list with G40 colored brackets +15/25%

Electric version e.PLUS 18, page 251

STANDARD FITTINGS

EG ø 1/2"

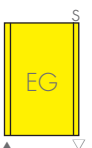

TAPPING CENTRES

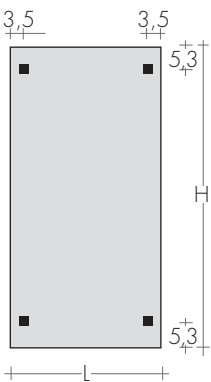
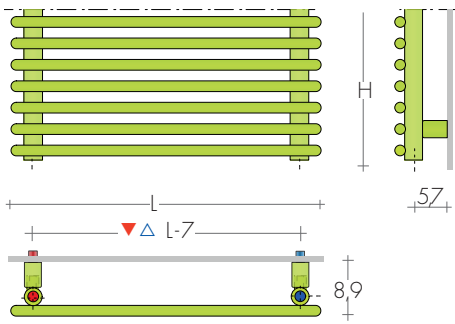

FIXINGS
Brackets Art. G40
included



PLUS 18 125-52

RECOMMENDED VALVES

CHROME VALVES KIT with:

- n°2 Valves with tailpieces
- n°2 Fittings (multilayer ø 16, copper ø 12, 14)
- n°2 Chrome wall plates ø 48, hole ø 16

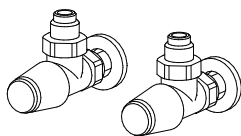

KIT ANGLED VALVES TON
page 269

Art. KVS 137,10€

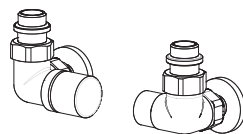

KIT SIDE control VALVES CYL with THERMOSTATIC
option, page 273
Art. KCL 162,50€
Extra for BREM color list 53,40€



SPECIAL FINISHES page 267
Finishes Gold, Bronze, Brushed Nickel for 2 valves
Brushed Nickel FITTING KIT extra Art. RN 30,50€

REMOTE FITTINGS Art. REM 42,10€
Tapping centres: at the rear of radiator ▲▼ EG
DISTANT Valves page 274

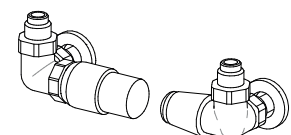

KIT SIDE control VALVES TON with Thermostatic
Head, page 269 Art. KTL 203,70€

PLUS-AIR

Towel warmer with a classic design suitable for installation in any bathroom. Made with

vertical collectors and round horizontal tubes, it is available in six heights and four

widths. The radiant tubes have terminals with an exclusive spherical shape.

DIMENSIONS

Width 42/52/62 cm

Height 101/136/171/185 cm

Depth 4,7 cm

Depth from wall 7,8 cm

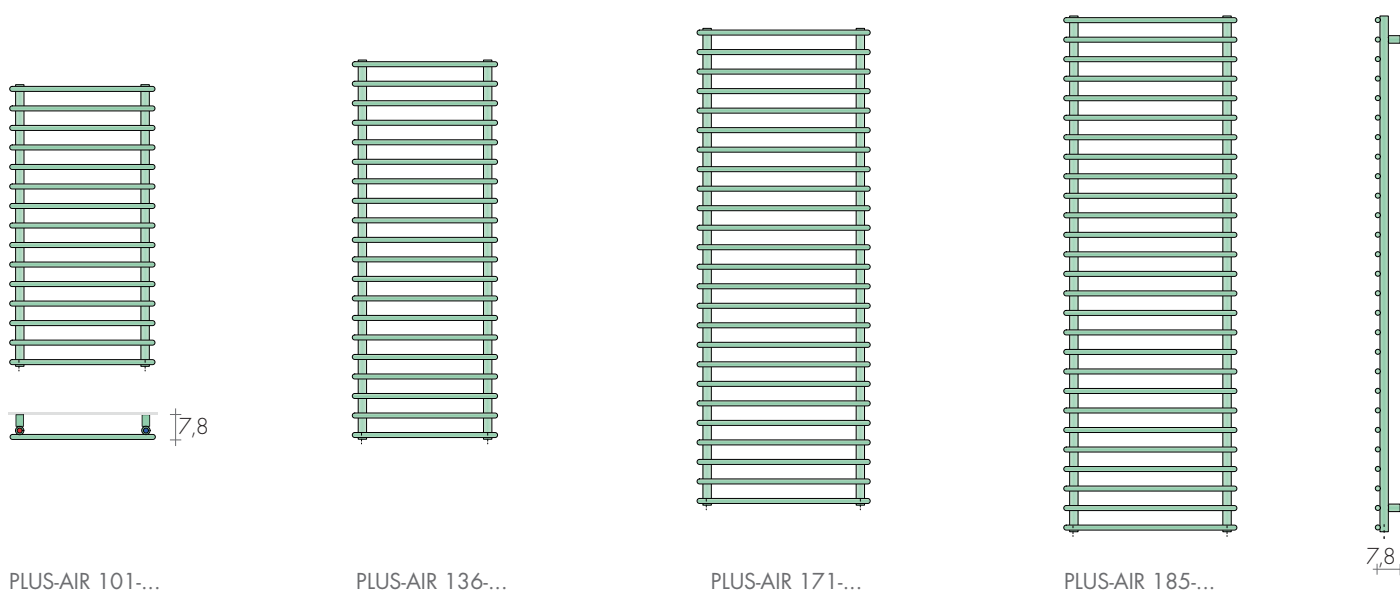

PLUS-AIR 101-...

PLUS-AIR 136-...

PLUS-AIR 171-...

PLUS-AIR 185-...

MODEL	H/L cm	Standard white sablé SB9016 €	EN 442			▲ ▽ t.c. cm	Height H cm	Width L cm	Weight M Kg	Volume V dm ³	DUAL FUEL VERSION with E.H.E. and* Watt €	
			Δt 50 K watt	Δt 40 K watt	Δt 30 K watt						Watt	€
PLUS-AIR	101-42	322,80	314	239	167	35	101	42	2,5	5,7	300	102,20
PLUS-AIR	101-52	334,80	363	276	193	45	101	52	2,8	6,6	400	103,40
PLUS-AIR	136-42	368,40	420	319	224	35	136	42	3,3	7,7	400	103,40
PLUS-AIR	136-52	382,00	485	369	259	45	136	52	3,7	8,8	500	105,60
PLUS-AIR	171-42	416,00	526	400	280	35	171	42	4,2	9,6	500	105,60
PLUS-AIR	171-52	435,10	608	462	324	45	171	52	4,7	11	650	107,80
PLUS-AIR	171-62	455,60	689	524	367	55	171	62	5,1	12,4	650	107,80
PLUS-AIR	185-42	457,90	569	433	303	35	185	42	4,5	10,4	500	105,60
PLUS-AIR	185-52	478,10	657	500	350	45	185	52	5,0	11,9	650	107,80
PLUS-AIR	185-62	498,60	744	566	397	55	185	62	5,6	13,4	800	112,60

*Dual fuel valve or T to be added p.207
Thermostats p.208-209

STANDARD PRODUCTION

White sablé SB9016 paintwork - G30 white brackets; Tolerance ± 3 mm - Air vent ø 1/2"

MAXIMUM OPERATING PRESSURE 8 BAR

PRODUCTION ON REQUEST

Paint to Brem color list with G30 colored brackets +15/25%

Electric version e-Plus-AIR p. 252

STANDARD FITTINGS

EG ø 1/2"



TAPPING CENTRES

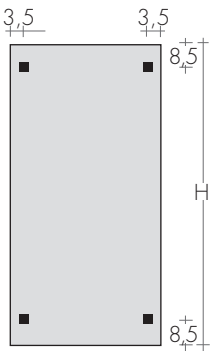
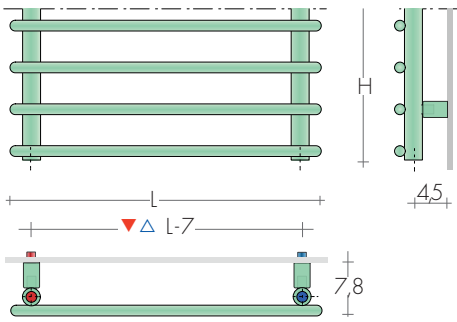

FIXINGS
Brackets Art. G30
included



PLUS-AIR 171-52

RECOMMENDED VALVES

CHROME VALVES KIT with:

- n°2 Valves with tailpieces
- n°2 Fittings (multilayer ø 16, copper ø 12, 14)
- n°2 Chrome wall plates ø 48, hole ø 16

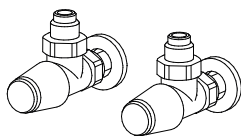

KIT ANGLED VALVES TON
page 269

Art. KVS 137,10€

SPECIAL FINISHES

page 267
Finishes Gold, Bronze, Brushed Nickel for 2 valves
Brushed Nickel FITTING KIT extra Art. RN 30,50€

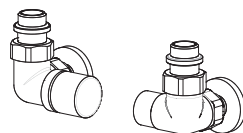

KIT SIDE control VALVES CYL with THERMOSTATIC
option, page 273
Art. KCL 162,50€
Extra for BREM color list 53,40€

REMOTE FITTINGS

Art. REM 42,10€
Tapping centres: at the rear of radiator ▲▼ EG
DISTANT Valves page 274

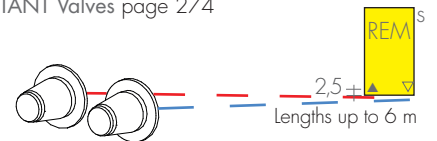

KIT SIDE control VALVES TON with Thermostatic
Head, page 269

Art. KTL 203,70€

RAW VERTICAL MODELS

RAW a particularly iconic product, its curved 25 mm diameter tubes have been

assembled and welded to form box shapes with an attractive diagonal cross in the centre.

Form without form, three dimensional and yet empty, a framework. *design Davide Diliberto*

DIMENSIONS

Width : 50/77 cm

Height : 50/77/104/130/157/183/210 cm

Depth : 10 cm

Depth from wall : 13,5 cm

RAW1

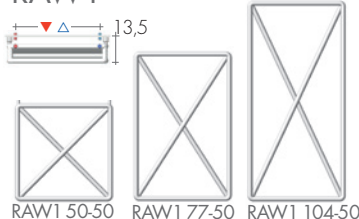

RAW1 50-50 RAW1 77-50 RAW1 104-50

RAW2

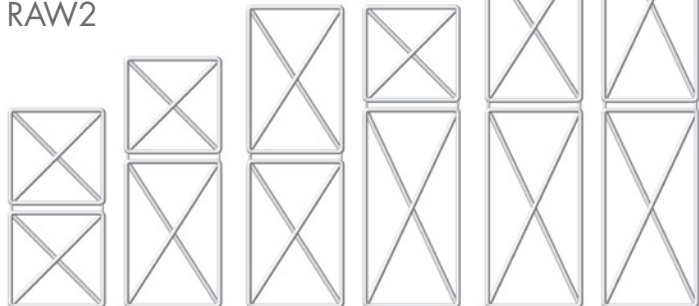

RAW2 104-50 RAW2 130-50 RAW2 157-50A RAW2 157-50B RAW2 183-50 RAW2 210-50

RAW3

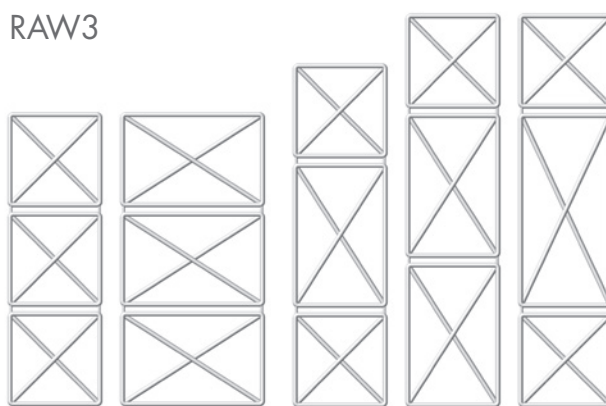

RAW3 157-50 RAW3 157-77 RAW3 183-50 RAW3 210-50A RAW3 210-50B



A'DESIGN AWARD
WINNER 2019
GOLD

VERTICAL MODELS

	HL cm	Standard white sablé SB 9016 €	EN 442			▲▼ t.c. cm	Height H cm	Width L cm	Weight M kg	Volume V dm ³	DUAL FUEL VERSION with E.H.E. and sleeve	
			Δt 50 K watt	Δt 40 K watt	Δt 30 K watt						Watt	€
RAW1	50-50	632,90	287	219	155	42	50,5	50,5	4,4	2,1	300	126,20
RAW1	77-50	731,40	356	272	192	42	77,0	50,5	5,5	2,7	400	127,40
RAW1	104-50	815,80	421	320	224	42	103,5	50,5	6,7	3,3	400	127,40
RAW2	104-50	1054,90	578	440	308	42	103,5	50,5	8,8	4,3	500	129,60
RAW2	130-50	1118,10	647	539	342	42	130,0	50,5	9,9	4,9	650	131,80
RAW2	157-50A	1181,40	712	539	376	42	156,5	50,5	11,1	5,5	800	136,60
RAW2	157-50B	1181,40	717	543	379	42	156,5	50,5	11,1	5,4	800	136,60
RAW2	183-50	1216,50	782	592	413	42	183,0	50,5	12,3	6,0	800	136,60
RAW2	210-50	1265,80	846	637	442	42	209,5	50,5	13,5	6,6	900	140,20
RAW3	157-50	1476,80	868	657	458	42	156,5	50,5	13,2	6,4	900	140,20
RAW3	157-77	1547,20	1077	815	569	68,5	156,5	77,0	16,6	8,2	1200	148,50
RAW3	183-50	1504,90	938	710	495	42	183,0	50,5	14,3	7,0	900	140,20
RAW3	210-50A	1519,10	1003	755	525	42	209,5	50,5	15,5	7,6	900	140,20
RAW3	210-50B	1519,10	1007	758	527	42	209,5	50,5	15,5	7,6	900	140,20

Other sizes and with 60 cm wide elements on request.

Thermostats p.228-229

MIXED VERSION
fittings EG ▲▼ 5 cm

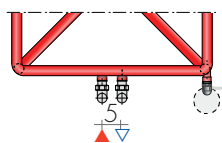

STANDARD PRODUCTION

White sablé SB9016 paintwork, B35 brackets

Tolerance ± 3mm - Air vent ø 1/8"

MAXIMUM OPERATING PRESSURE 8 BAR

PRODUCTION ON REQUEST

Paintwork to BREM color list with

colored B35 brackets

Electric version, e.Raw page 254

+15/25%

STANDARD FITTING EG ø 1/2"

Fittings 3/8" on request

Feet and dividers, on request

Special fittings, page 278



TAPPING CENTRES

EG vertical standard fittings

Side fittings, on request without extra

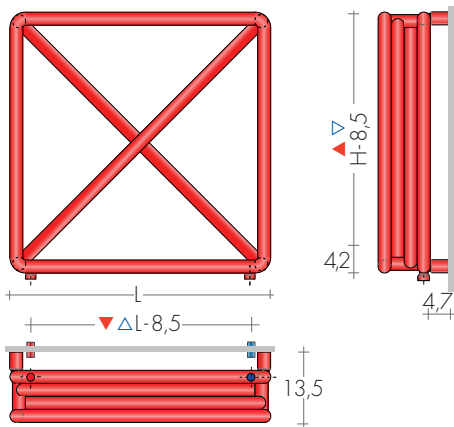

DESIGN YOUR RADIATOR BY COMPOSING BASIC MODULES

Request feasibility and quotation

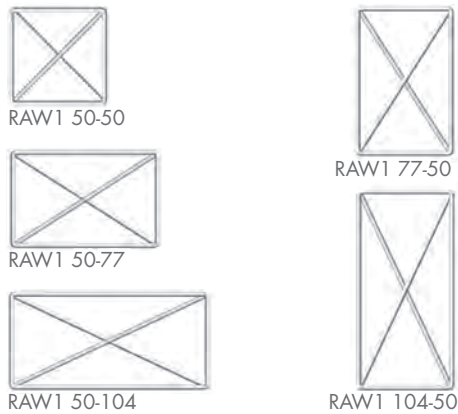

FIXINGS

Brackets included

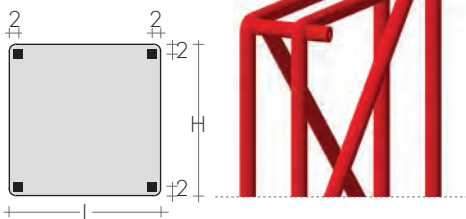

RECOMMENDED VALVES

CHROME VALVES KIT with:

- n°2 Valves with tailpieces
- n°2 Fittings (multilayer ø 16, copper ø 12, 14)
- n°2 Chrome wall plates ø 48, hole ø 16

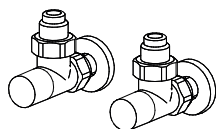

KIT ANGLED VALVES MINI page 270
chrome-plated or white color Art. KMS 124,00€

SPECIAL FINISHES

page 267
Finishes Gold, Bronze, Brushed Nickel for 2 valves
Brushed Nickel FITTING KIT extra Art. RN 30,50€

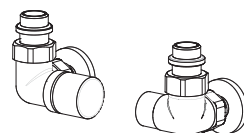

KIT SIDE control VALVES CYL with THERMOSTATIC
option, page 273 Art. KCL 162,50€
Extra for BREM color list 53,40€

REMOTE FITTINGS

Art. REM 42,10€
Tapping centres: at the rear of radiator ▲▼ EG
DISTANT Valves page 274

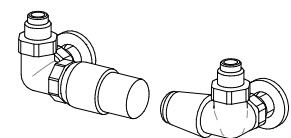
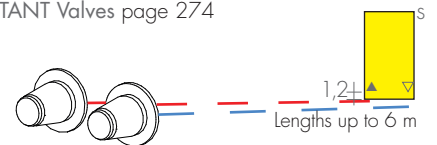

KIT SIDE control VALVES TON with Thermostatic
Head, page 269 Art. KTL 203,70€

RAW HORIZONTAL MODELS

RAW a particularly iconic product, its curved 25 mm diameter tubes have been

assembled and welded to form box shapes with an attractive diagonal cross in the centre.

Form without form, three dimensional and yet empty, a framework. *design Davide Diliberto*

DIMENSIONS

Width : 77/104 cm

Height : 50 /77/104/130/157 cm

Depth : 10 cm

Depth from wall : 13,5 cm



A'DESIGN AWARD
WINNER 2019
GOLD

RAW1



RAW1 50-77



RAW1 50-104

RAW2



RAW2 50-104



RAW2 50-130



RAW2 50-157A



RAW2 50-157B



RAW2 77-104



RAW2 104-77



RAW2 104-77

RAW3



RAW3 50-157

HORIZONTAL MODEL	HL cm	Standard white sablé SB 9016 €	EN 442			▲▽ t.c. cm	Height H cm	Width L cm	Weight M Kg	Volume V dm ³	DUAL FUEL VERSION with E.H.E. and sleeve	
			Δt 50 K watt	Δt 40 K watt	Δt 30 K watt						Watt	€
RAW1	50-77	731,40	356	272	192	68,5	50,5	77,0	5,5	2,7	400	127,40
RAW1	50-104	815,80	421	320	224	95	50,5	103,5	6,7	3,3	400	127,40
RAW2	50-104	1054,90	578	440	308	95	50,5	103,5	8,8	4,3	650	131,80
RAW2	50-130	1118,10	647	492	345	121,5	50,5	130	9,9	4,9	650	131,80
RAW2	50-157A	1181,40	712	539	376	148	50,5	156,5	11,1	5,5	650	131,80
RAW2	50-157B	1181,40	717	543	379	148	50,5	156,5	11,1	5,4	650	131,80
RAW2	77-104	1181,40	717	543	379	95	77,0	103,5	11,1	5,4	650	131,80
RAW2	104-77	1181,40	726	548	384	68,5	103,5	77,0	11,1	5,4	800	136,60
RAW3	50-157	1476,80	868	657	458	148	50,5	156,5	13,2	6,4	900	140,20

*horizontal resistance

Thermostats p.228-229

MIXED VERSION fittings EG ▲▽ 5 cm

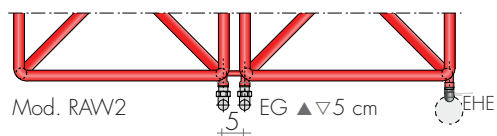
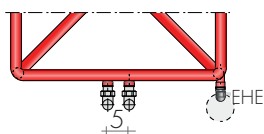

STANDARD PRODUCTION

White "sablé" paintwork - white B35 brackets

Tolerance ± 3mm - Air vent ø 1/8"

MAXIMUM OPERATING PRESSURE 8 BAR

PRODUCTION ON REQUEST

Paintwork to BREM color list with colored B35 brackets

Electric version, e.Raw page 254

+1,5/25%

STANDARD FITTING EG ø 1/2"

Fittings 3/8" on request

Feet and dividers, on request

Special fittings, page 279

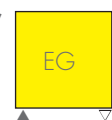

TAPPING CENTRES

EG vertical standard fittings
Side fittings, on request without extra

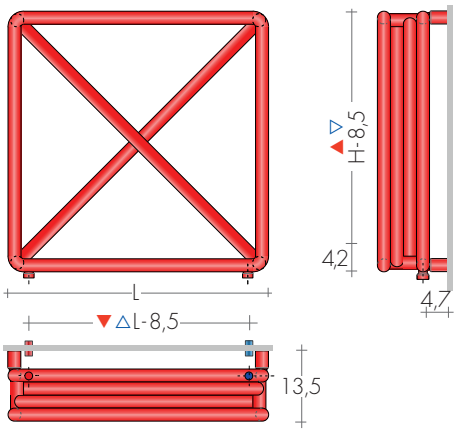

FIXINGS

Brackets included

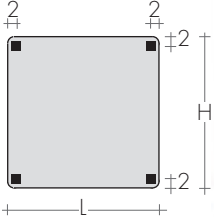

RECOMMENDED VALVES

CHROME VALVES KIT with:

- n°2 Valves with tailpieces
- n°2 Fittings (multilayer ø 16, copper ø 12, 14)
- n°2 Chrome wall plates ø 48, hole ø 16

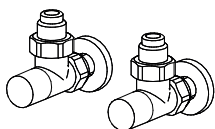

KIT ANGLED VALVES MINI page 270
chrome-plated or white color Art. KMS 124,00€

SPECIAL FINISHES

page 267
Finishes Gold, Bronze, Brushed Nickel for 2 valves
Brushed Nickel FITTING KIT extra Art. RN 30,50€

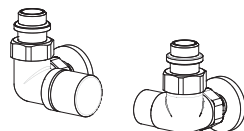

KIT SIDE control VALVES CYL with THERMOSTATIC
option, page 273 Art. KCL 162,50€
Extra for BREM color list 53,40€

REMOTE FITTINGS

Art. REM 42,10€
Tapping centres: at the rear of radiator ▲▽ EG
DISTANT Valves page 274

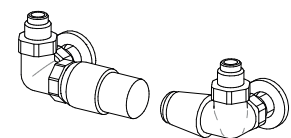
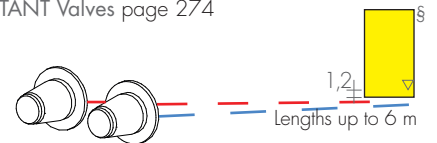

KIT SIDE control VALVES TON with Thermostatic
Head, page 269 Art. KTL 203,70€

SHAR

SHAR has all the main characteristics of a traditional heated towel rail. Its aesthetic

harmony arises from the semi-oval shape of the manifolds, which are reduced to minimum

dimensions and with radiating tubes of \varnothing 15 mm, they portray lightness and solidity.

DIMENSIONS

Width 33 / 45 / 50 / 60 / 75 cm

Height 71,8 / 110,3 / 140,6 / 181,8 cm

Depth 3 cm

Depth from wall 10 cm

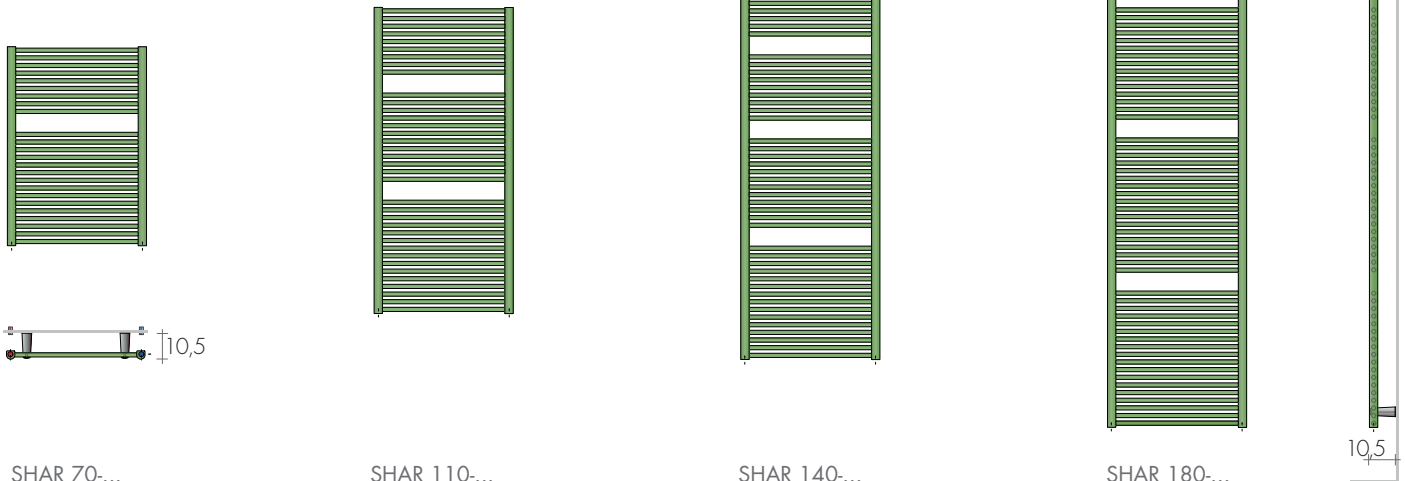

MODEL	HL cm	Standard white sablé SB 9016 €	EN 442			▲ ▽ t.c. cm	Height H cm	Width L cm	Weight M Kg	Volume V dm ³	DUAL FUEL VERSION with E.H.E. and*	
			Δt 50K watt	Δt 40K watt	Δt 30K watt						Watt	€
SHAR	70-45	400,00	353	267	181	42	71,8	45	4,9	3,12	400	103,40
SHAR	70-50	410,90	389	294	200	47	71,8	50	5,3	3,27	400	103,40
SHAR	70-60	427,10	458	346	235	57	71,8	60	6,1	3,59	500	105,60
SHAR	110-45	519,70	526	397	270	42	110,3	45	7,4	4,74	500	105,60
SHAR	110-50	532,90	580	438	298	47	110,3	50	8,0	4,97	650	107,80
SHAR	110-60	556,50	684	516	352	57	110,3	60	9,2	5,45	650	107,80
Slim SHAR	140-33	612,00	468	353	241	30	140,6	33	7,3	4,51	500	105,60
SHAR	140-45	653,50	653	493	336	42	140,6	45	9,3	6,00	650	107,80
SHAR	140-50	671,30	720	544	370	47	140,6	50	10,0	6,29	800	112,60
SHAR	140-60	699,90	851	643	437	57	140,6	60	11,6	6,88	900	116,20
Slim SHAR	180-33	748,00	618	467	318	30	181,8	33	9,7	4,89	650	107,80
SHAR	180-45	798,80	870	657	447	42	181,8	45	12,2	7,85	900	116,20
SHAR	180-50	820,70	955	721	491	47	181,8	50	13,2	8,24	900	116,20
SHAR	180-60	856,60	1126	850	579	57	181,8	60	15,3	9,03	1200	124,50
SHAR	180-75	912,90	1363	1029	701	72	181,8	75	18,1	10,21	1500	135,40
VERSION - CHROME												
S-CROM	70-50	941,20	311	235	160	47	71,8	50	5,3	3,27	300	102,20
S-CROM	110-50	1220,80	464	350	238	47	110,3	50	8,0	4,97	500	105,60
S-CROM	110-60	1303,90	547	413	281	57	110,3	60	9,2	5,45	500	105,60
S-CROM	140-33	1400,30	374	282	193	30	140,6	33	7,3	4,51	400	103,40
S-CROM	140-50	1538,80	576	435	296	47	140,6	50	10,0	6,29	650	107,80
S-CROM	180-33	1715,20	494	373	254	30	181,8	33	9,7	4,89	500	105,60
S-CROM	180-45	1836,40	696	526	358	42	181,8	45	12,2	7,85	650	107,80
S-CROM	180-50	1879,00	764	577	393	47	181,8	50	13,2	8,24	800	112,60

Made-to-measure versions on request Available Stock in standard white

*Dual fuel valve or T to be added p.207
Thermostats p.208-209

MAXIMUM OPERATING PRESSURE 8 BAR

STANDARD PRODUCTION

White "sablé" paintwork-white brackets M8B
Chrome-plated finish with chrome-pl. brackets
Tolerance \pm 3 mm - Air vent \varnothing 1/8"

PRODUCTION ON REQUEST

Paint to Brem color list with
chrome-plated M8C brackets +15%/25%
Electric version e.Shar, page 257

STANDARD FITTINGS

EG \varnothing 1/2"
Special fittings, page 279
Shar as a divider, page 202



TAPPING CENTRES

EG vertical standard fittings

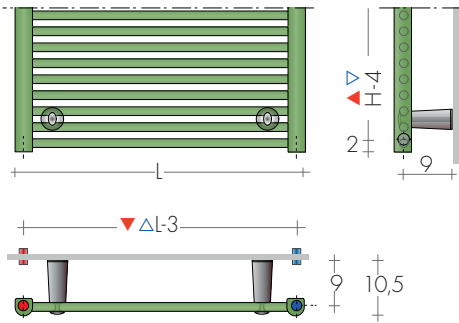

Side fittings on request ▲▼ H-4 cm, ø 1/2"
Extra Art. AS 91,20€

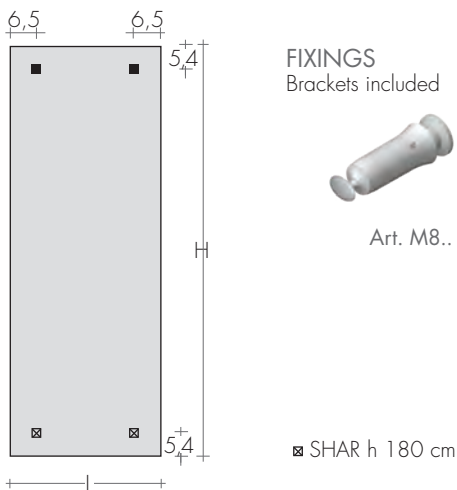

S-CROM 140-50

RECOMMENDED VALVES

CHROME VALVES KIT with:

- n°2 Valves with tailpieces
- n°2 Fittings (multilayer ø 16, copper ø 12, 14)
- n°2 Chrome wall plates ø 48, hole ø 16

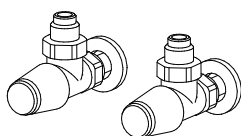

KIT ANGLED VALVES TON
page 269

Art. KVS 137,10€

SPECIAL FINISHES

Finishes Gold, Bronze, Brushed Nickel for 2 valves
Brushed Nickel FITTING KIT extra Art. RN 30,50€

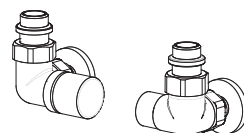

KIT SIDE control VALVES CYL with THERMOSTATIC
option, page 273 Art. KCL 162,50€
Extra for BREM color list 53,40€

REMOTE FITTINGS

Art. REM 42,10€
Tapping centres: at the rear of radiator ▲▼ EG
DISTANT Valves page 274

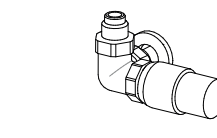
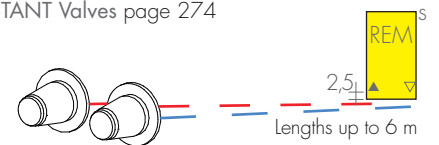

KIT SIDE control VALVES TON with Thermostatic
Head, page 269 Art. KTL 203,70€

SHAR-AIR

SHAR-AIR is the traditional towel warmer suitable for any room. The semioval main-

pipes and the tubes with a diameter of 15 mm are repeated at different rates, forming

harmonious balance and wide range of thermal outputs.

DIMENSIONS

Width 50 / 60 cm

Height 94,5/105,5/122/124,5/144,5/162/182/183,5/184,5 cm

Depth 3 cm

Depth from wall 10 cm



SHAR-AIR
95-50

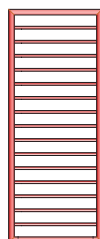

SHAR-AIR
125-50



SHAR-AIR
162-50



SHAR-AIR
184-50

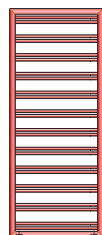
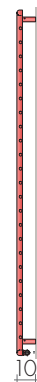

SHAR-A2R
122-50

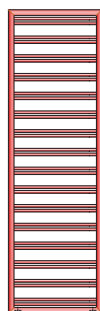

SHAR-A2R
162-50

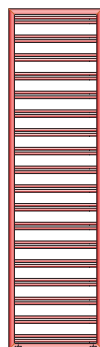

SHAR-A2R
182-50

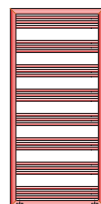

SHAR-A3R
105-50



SHAR-A3R
145-50

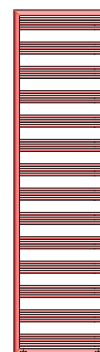

SHAR-A3R
183-50



MODEL	HL cm	Standard white sablé SB 9016 €	EN 442			▲ ▽ t.c. cm	Height H cm	Width L cm	Weight M Kg	Volume V dm ³	DUAL FUEL VERSION with E.H.E. and sleeve	
			Δt 50K watt	Δt 40K watt	Δt 30K watt						Watt	€
SHAR-AIR	95-50	536,70	301	225	155	38	94,5	50	5	2,4	300	126,20
SHAR-AIR	125-50	585,30	387	289	199	38	124,5	50	6,3	3	400	127,40
SHAR-AIR	162-50	684,90	493	369	253	38	162	50	7,9	3,8	500	129,60
SHAR-AIR	184-50	722,50	558	417	287	38	184,5	50	8,9	4,3	500	129,60
SHAR AIR	184-60	750,50	636	476	327	48	184,5	60	9,9	4,7	650	131,80
SHAR-A2R	122-50	665,30	498	373	256	38	122	50	7,6	3,5	500	129,60
SHAR-A2R	162-50	796,70	647	484	333	38	162	50	9,7	4,5	650	131,80
SHAR-A2R	182-50	853,10	721	539	371	38	182	50	10,8	5	800	136,60
SHAR-A2R	182-60	905,70	837	626	430	48	182	60	12,3	5,6	900	140,20
SHAR-A3R	105-50	639,90	479	358	246	38	105,5	50	7,2	3,3	500	129,60
SHAR-A3R	145-50	786,80	639	478	328	38	144,5	50	9,5	4,3	650	131,80
SHAR-A3R	183-50	945,40	799	598	411	38	183,5	50	11,7	5,4	800	136,60
SHAR-A3R	183-60	1008,60	932	697	479	48	183,5	60	13,4	6,1	900	140,20

Thermostats p.228-229

STANDARD PRODUCTION

White sablé SB9016 paintwork, B70 brackets
Tolerance ± 3mm - Air vent ø 1/8"

MAXIMUM OPERATING PRESSURE 8 BAR

PRODUCTION ON REQUEST

Paintwork to BREM color list with
colored B70 brackets

Electric version e.Shar-AIR page 258

+15/25%

STANDARD FITTINGS

REG ø 1/2"

Feet and dividers, page 202

Special fittings, page 279



TAPPING CENTRES

REG fittings with reverse valves as standard
SHAR-AIR

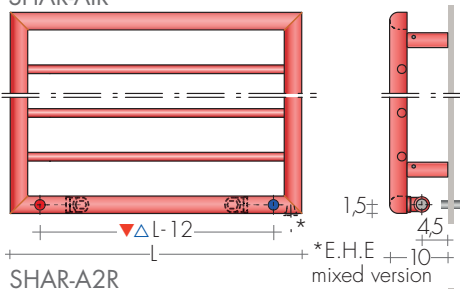

SHAR-A2R

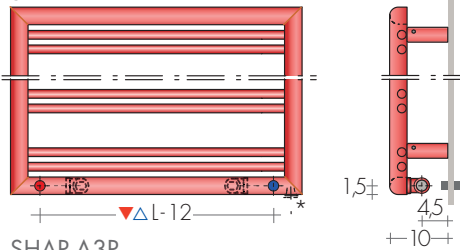

SHAR-A3R

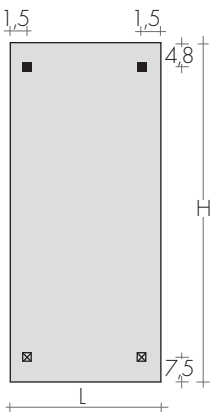
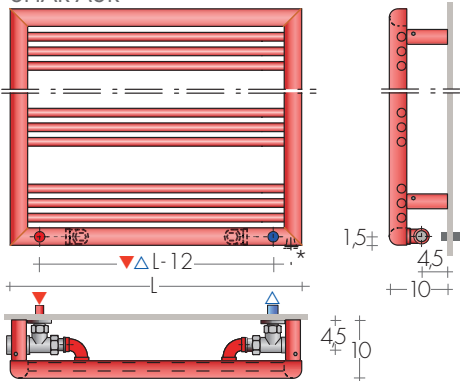

FIXINGS
Brackets B70 included



SHAR-AIR 162-50

SHAR-A2R 162-50

SHAR-A3R 183-50

RECOMMENDED VALVES

CHROME VALVES KIT with:

- n°2 Valves with tailpieces
- n°2 Fittings (multilayer ø 16, copper ø 12, 14)
- n°2 Chrome wall plates ø 48, hole ø 16

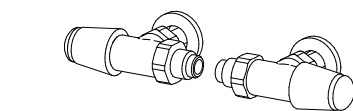

KIT REVERSE VALVES TON
page 269

Art. KVR 137,10€

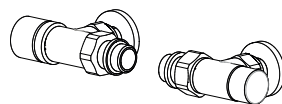

KIT REVERSE VALVES CYL with thermostatic option
page 273
Art. KCR 149,90€
Extra for BREM color list 53,40€

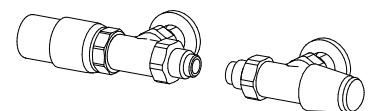

KIT REVERSE VALVES TON with THERMOSTATIC
Head page 269
Art. KTR 190,30€

SPECIAL FINISHES

page 267
Finishes Gold, Bronze, Brushed Nickel for 2 valves
Brushed Nickel FITTING KIT extra Art. RN 30,50€

REMOTE FITTINGS

Art. REM 42,10€
Tapping centres: at the rear of radiator ▲▼ L - 16cm
DISTANT Valves page 274

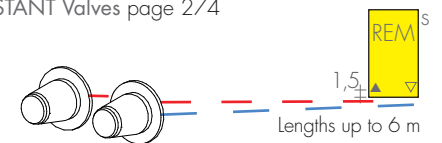

START START CURVO

The START heated towel rail is produced using thin radiating $\varnothing 12$ tubes connected to vertical manifolds forming the exclusive

pointed arch shape. The straight version is unusual in that it has offset upper tubes to improve the distribution of the heat. The

START CURVO is the first heated towel rail with rounded surfaces. The original design of pure and slightly arched lines makes START unique.

DIMENSIONS

Width 35 / 45 / 55 / 60 cm

Height 75 / 90 / 120 / 150 / 180 cm

Depth 4,7 cm

Depth from wall 10 cm

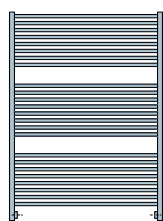

START 75 - ...

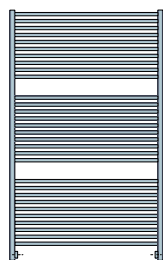

START 90 - ...
ST-CURVO 90-55

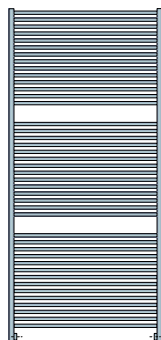

START 120 - ...
ST-CURVO 120-55

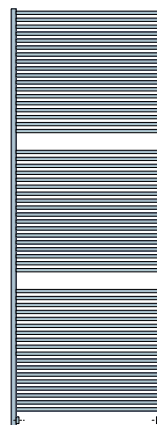

START 150 - ...
ST-CURVO 150-55



START 180 - ...

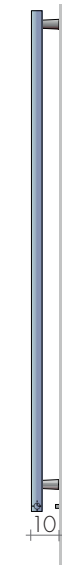

MODEL	H-L cm	Standard white sablé SB 9016 €	EN 442			▲ ▼ t.c. cm	Height H cm	Width L cm	Weight M Kg	Volume V dm ³	DUAL FUEL VERSION with E.H.E. and sleeve	
			Δt.50K wall	Δt.40K wall	Δt.30K wall						Watt	€
START	75-45	418,50	339	256	174	31	75	45	4,4	1,46	300	126,20
START	75-55	438,30	401	303	206	41	75	55	5,0	1,65	400	127,40
START	90-45	511,80	409	309	210	31	90	45	5,4	1,79	400	127,40
START	90-55	533,60	484	365	249	41	90	55	6,2	2,03	500	129,60
START	120-45	612,00	552	417	284	31	120	45	7,4	2,46	500	129,60
START	120-55	634,00	654	494	336	41	120	55	8,6	2,79	650	131,80
Slim START	150-35	742,80	573	433	295	21	150	35	7,1	2,43	650	131,80
START	150-45	764,40	703	531	361	31	150	45	9,4	3,12	650	131,80
START	150-55	797,10	832	628	428	41	150	55	10,9	3,54	800	136,60
START	180-45	876,50	861	650	443	31	180	45	11,5	3,78	900	140,20
START	180-55	909,10	1016	767	522	41	180	55	13,3	4,30	900	140,20
START	180-60	931,30	1094	826	562	46	180	60	14,2	4,56	1200	148,50
CHROME-PLATED- START												
ST-CROM	90-45	1139,80	327	247	168	31	90	45	5,4	1,79	300	126,20
ST-CROM	90-55	1189,00	386	291	199	41	90	55	6,2	2,03	400	127,40
ST-CROM	120-45	1361,70	442	334	227	31	120	45	7,4	2,46	400	127,40
ST-CROM	120-55	1410,90	523	395	269	41	120	55	8,6	2,79	500	129,60
ST-CROM	150-45	1702,00	562	424	289	31	150	45	9,4	3,12	500	129,60
ST-CROM	150-55	1776,10	666	503	343	41	150	55	10,9	3,54	650	131,80
ST-CROM	180-35	1902,70	565	427	291	21	180	35	9,6	2,94	500	129,60
ST-CROM	180-55	2025,30	813	614	418	41	180	55	13,3	4,30	800	136,60
START CURVO												
ST-CURVO	90-55	732,80	484	365	249	39,5	90	54	6,2	2,03	500	129,60
ST-CURVO	120-55	851,30	654	494	336	39,5	120	54	8,6	2,79	650	131,80
ST-CURVO	150-55	1038,70	832	628	428	39,5	150	54	10,9	3,54	900	140,20
CHROME-PLATED- START CURVO												
C-CROM	120-55	1778,60	523	395	269	39,5	120	54	8,6	2,79	500	129,60
C-CROM	150-55	2169,60	666	503	343	39,5	150	54	10,9	3,54	650	131,80

Customized dimensions on request

Available Stock in standard white

Thermostats p.228-229

STANDARD PRODUCTION

White sablé SB9016 paintwork, brackets white
Tolerance ± 3 mm - Air vent $\varnothing 1/8"$
Maximum operating pressure 8 bar

PRODUCTION ON REQUEST

Paint to Brem color list
chrome-plated M.. brackets +15/25%
Electric version e.Start page 259

STANDARD FITTING

REG $\varnothing 1/2"$
EG and side fittings, on request
Start as a divider, page 202

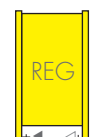

TAPPING CENTRES REG

Model START, as standard REG connections

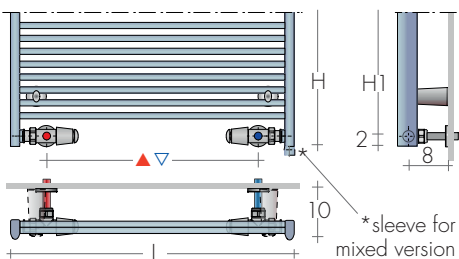

Model START CURVO, as standard REG connections

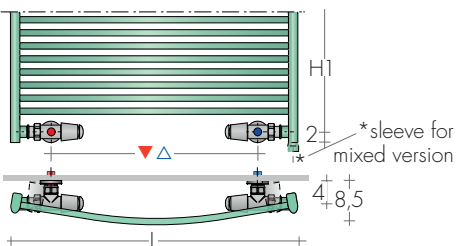

Height (H1) is 4 cm less for:

- EG FITTING (t.c. L-1,8cm)
- SIDE FITTINGS AC/BD (t.c. H1-4cm)

On request Extra Art. AS 91,20€

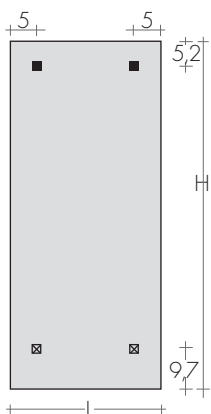

FIXINGS
Brackets included



START Art. M8..



Start CURVO Art. M4F..

☒ H 180 cm



START 180-45

RECOMMENDED VALVES

CHROME VALVES KIT with:

- n°2 Valves with tailpieces
- n°2 Fittings (multilayer ø 16, copper ø 12, 14)
- n°2 Chrome wall plates ø 48, hole ø 16

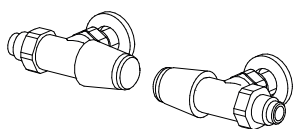

KIT REVERSE VALVES TON
page 269

Art. KVR 137,10€

SPECIAL FINISHES

page 267
Finishes Gold, Bronze, Brushed Nickel for 2 valves
Brushed Nickel FITTING KIT extra Art. RN 30,50€

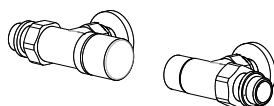

KIT REVERSE VALVES CYL with thermostatic option
page 273 Art. KCR 149,90€
Extra for BREM color list 53,40€

REMOTE FITTINGS

Art. REM 42,10€
Tapping centres: at the rear of radiator ▲▽ EG
DISTANT Valves page 274

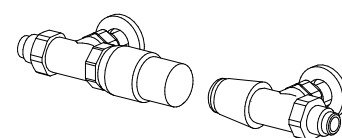
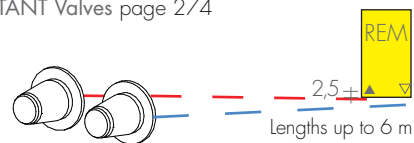

KIT REVERSE VALVES TON with THERMOSTATIC
Head page 269 Art. KTR 190,30€

SHAR DIVIS START DIVIS KUAD DIVIS

TOWEL HEATER DIVIDERS

SHAR, START and KUAD heated towel rail, with the addition of feet and side or

ceiling fittings, can be used as partitions in bathrooms, kitchens or other rooms

wherever you want a stylish, functional separation.

REVERSE FITTINGS

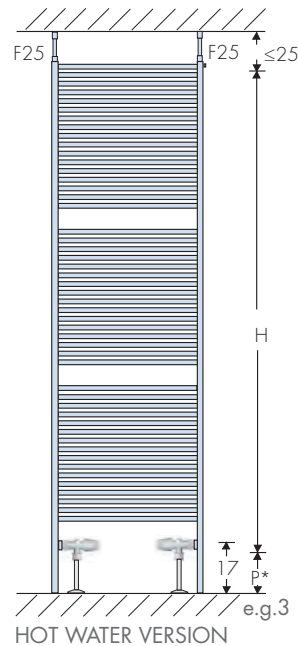
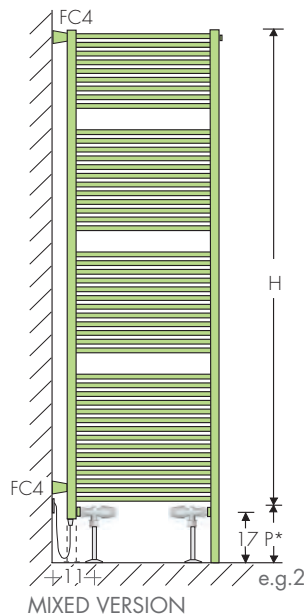
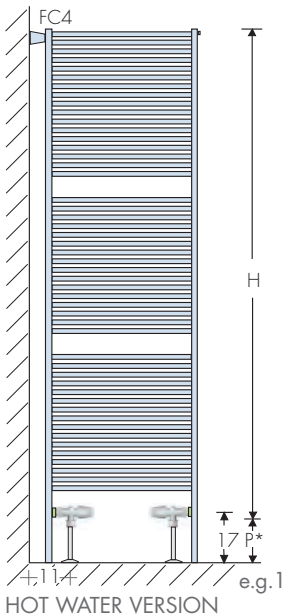

VERTICAL FITTINGS

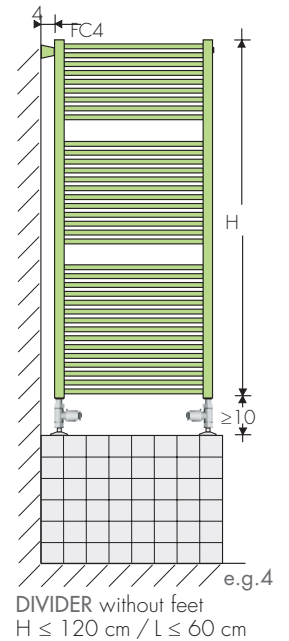

TOWEL HEATER DIVIDERS

SHAR DIVIS: standard H + 19 cm (P*)

START/KUAD DIVIS: standard H + 15 cm (P*)

MANIFOLD FOOT (P*)

Shar foot (each) Art. PC19 100,10€

Start/Kuad foot (each) Art. PC15 100,10€

FOOT COVER (each) Art. PT 36,60€

PAINTED SIDE BRACKET can be reduced from 10 to 4 cm Art. F10 83,90€

PAINTED CEILING BRACKET can be reduced from 25 to 4 cm Art. F25 87,50€

CHROME-PLATED BRACKET (with 1/8" sleeve) adjustable, 4-6 cm Art. FC4 71,80€

REVERSE or SIDE ø 1/2" FITTINGS

for towel heaters dividers Art. AS 91,20€

Side fitting tapping centre Shar: H - 4 cm

Side fitting tapping centre Start/Kuad: H - 4 - 4 cm

Reverse fitting tapping centre Shar: L - 17,7 cm

Reverse fitting tapping centre Start/Kuad: L - 14 cm

SLEEVE ø 1/2" or ø 3/8" for

Electrical Immersion Heater p. 207

Art. M12 24,00€

Art. M38 24,00€

"Always send us a drawing with measurements"

SIDE FITTINGS

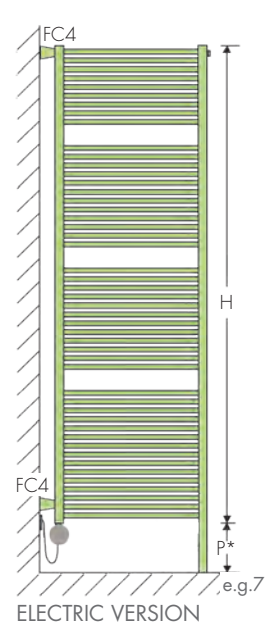
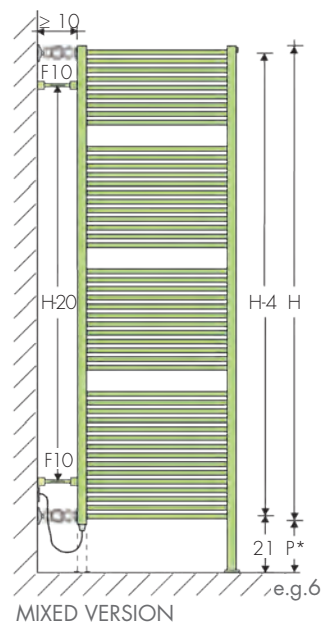
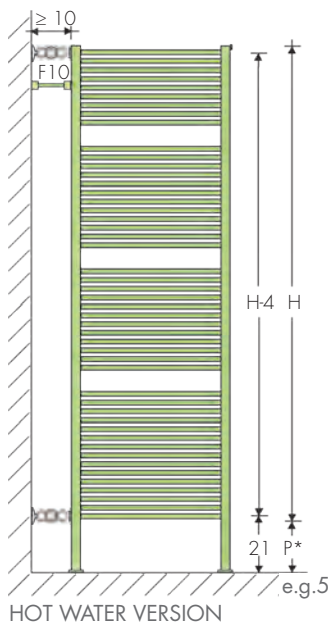

CHROME PLATED TOWEL HEATER DIVIDERS
Ask for feasibility study and estimate.

CROSS AS A DIVIDER page 58

STANDARD PRODUCTION

White "sablé" paintwork -RAL9016

Air vent ø 1/8" - Tolerance ± 3mm

MAXIMUM OPERATING PRESSURE 8 BAR

PRODUCTION ON REQUEST

Paintwork to Brem color list with specified brackets +15/25%

Chrome-plated version, on request

STANDARD FITTING

REG (BD/AC) ø 1/2"

EG ø 1/2"

Electric version, on request

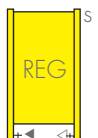

SHAR MODEL

SIDE FITTINGS

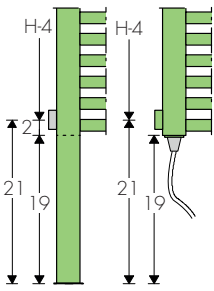

REVERSE FITTINGS

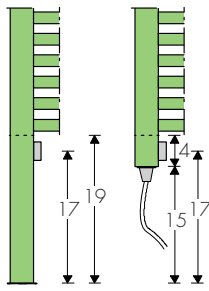

START/KUAD MODEL

SIDE FITTINGS

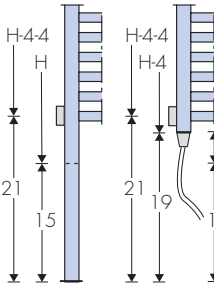

REVERSE FITTINGS

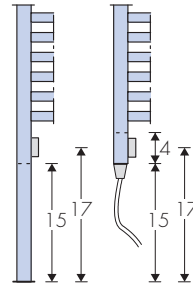

The price of towel heater dividers is obtained by adding to the cost of the standard white model:
 - feet, brackets and fittings,
 - accessories, valves, tube covers and rose washers

E.g. 1: START DIVIS (water) 180-55 (H+15cm)

START 180-55 white	n°1	909,10€
Art. PC15 foot h=15	n°2	200,20€
Art. FC4	n°1	71,80€
Art. AS towel heater divider fittings	n°1	91,20€
Tot.		1272,30€

E.g. 2: SHAR DIVIS (dual fuel version) 180-50(H+19cm)

SHAR 180-50 white	n°1	820,70€
Art. PC19 foot h=19 cm	n°1	100,10€
Art. FC4	n°2	143,60€
Art. M38 for R.E.	n°1	24,00€
Art. R900II for R.E. 900W	n°1	116,20€
Art. AS towel heater divider fittings	n°1	91,20€
Tot.		1295,80€

E.g. 5: e.KUAD DIVIS (electric) 175-50 (H+15cm)

e.KUAD 175-50 white	n°1	889,60€
Art. PC15 foot h=15 cm	n°1	100,10€
Art. FC4	n°2	143,60€
KIT RT 900IIT	n°1	255,30€
White Termostat	Art. DYPB	89,60€
Tot.		1478,20€



START DIVIS 180-55

RECOMMENDED VALVES

CHROME VALVES KIT with:

- n°2 Valves with tailpieces
- n°2 Fittings (multilayer ø 16, copper ø 12, 14)
- n°2 Chrome wall plates ø 48, hole ø16

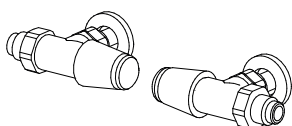

KIT REVERSE VALVES TON
page 269

Art. KVR 137,10€

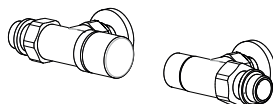

KIT REVERSE VALVES CYL with thermostatic option
page 273
Extra for BREM color list

Art. KCR 149,90€
53,40€

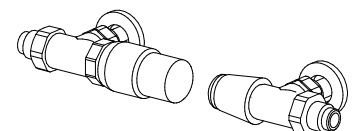

KIT REVERSE VALVES TON with THERMOSTATIC
Head page 269

Art. KTR 190,30€

SPECIAL FINISHES

Finishes Gold, Bronze, Brushed Nickel for 2 valves
 Brushed Nickel FITTING KIT extra Art. RN 30,50€

page 267

SIDE FITTINGS VALVES

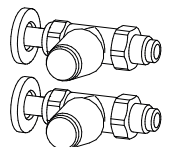

KIT STRAIGHT VALVES TON
p. 269 Art. KVD 149,30€

ELECTRIC INDEX

- A GREEN CHOICE
- INDEPENDENCE FROM THE CENTRAL HEATING SYSTEM
- FOR EXTRA HEAT AT LOW TEMPERATURES
- SMART DOMOTIC DIALOGUE
- ENERGY-SAVING PTC ELECTRICAL HEATING ELEMENTS AND A SPECIAL ADJUSTABLE FITTING ON THE REAR

RADIATORS COLLECTION

	page
e.CHEM	214
e.CLAK	216
e.CROSS-G	220
e.CROSS-Q	221
e.CROSS-V	220
e.LAME	230
e.LAME-UP	231
e.HERG	235
e.PHUL	247
e.REGULAR	255

BREM offers a wide range of radiators and electric towel warmers representing nearly all products presented by Brem.

TOWEL HEATER COLLECTION

	page
e.ALIS	210
e.ASYMM e.ASYMP	211
e.CAMEO	212
e.CANNUCCIA STRAW	213
e.CHEM-M e.CHEM-S	214
e.CLARK	217
e.CROSS	218
e.CROSS-CROM ..-FO/FA	219
e.CROSS-Q	221
e.CROSS-R	222
e.CUBICO	223
e.DUO	224
e.ESSEN	225
e.FIT	226
e.FLAG	227
e.FRAC	228
e.FREE	229
e.GEOMETRICA-T ..-O	230
e.GEOMETRICA-Q ..-R	231
e.GUEST	232
e.HAND	233
e.HERG-OT	234
e.HERG'S	235
e.HOOK	236
e.KORE PLUS	237
e.KUAD	238
e.KUO	239
e.LAMATH	240
e.LAME SLIM	242
e.MAHN	244
e.MAHN-AIR	245
e.MANT	246
e.PIT	248
e.PLANK e.PLANK-AIR	249
e.PLATT	250
e.PLUS 12	251
e.PLUS18 e.PLUS-AIR	252
e.QUAR	253
e.RAW	254
e.SBARRA e.SBARRA-UP	256
e.SHAR	257
e.SHAR-AIR	258
e.START	259
e.UNIPLATT	260
e.VELETTA	261
e.VISION	262
e.ZOOM	263

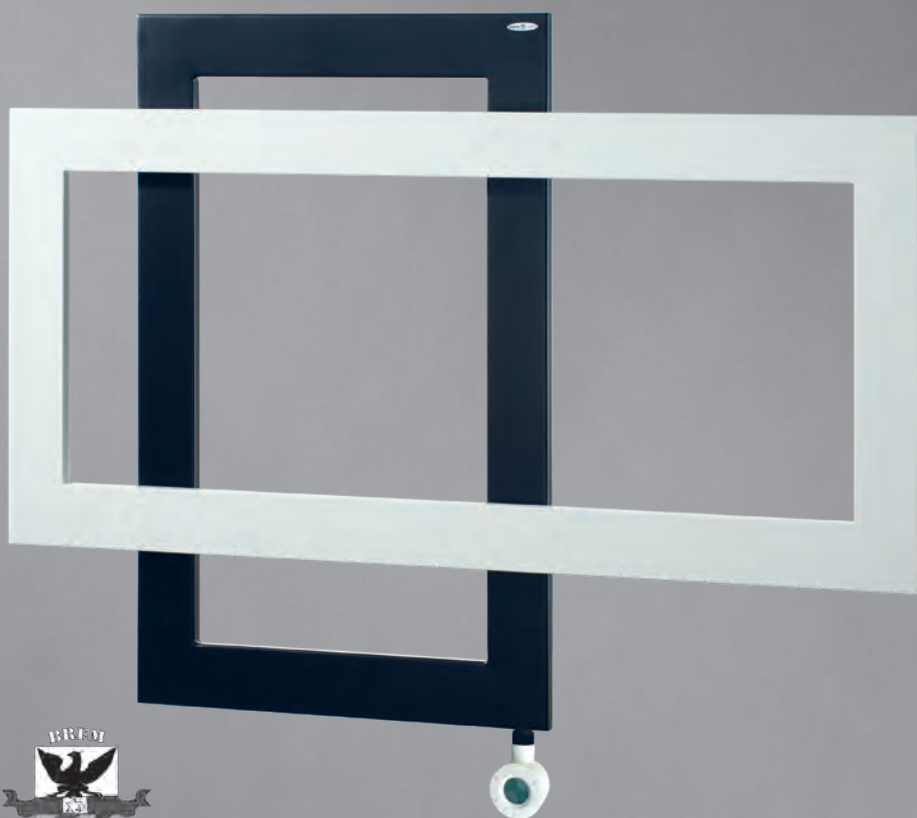

ELECTRIC HEATING ELEMENT

BREM uses PTC electric heating element. PTC means "Positive Temperature Coefficient" and characterizes the electrical behaviour of the semiconductor heater segment: with increasing temperature the resistance of the PTC element rises instantaneously and reduces automatically the power output generating the so called "self-limiting" effect.

1200W and 1500W electric heating elements work using constant power and are equipped with thermal limiter that stops the emission of heat.

The class II PTC heating up process will automatically go through three phases:

- Start-up. In the first 60 sec the PTC works at 130% circa of the nominal power ("turbo boost power" effect) to trigger best the convection inside the radiator;
- Nominal power phase. In this phase the PTC heating elements reaches the equilibrium temperature working at the nominal power;
- Energy saving phase. With the increasing of the ambient temperature the power output decreases until a new equilibrium is reached where the power consumption is reduced (typically at 70% - 80% of the nominal power).

The PTC electric heating elements (CE marked) have the following advantages:

- Intrinsic safety (no risk of overheating, burnings or fire)
- No need of thermofuse and therefore no more burnt heaters also in case of partial filling
- Reduced diameter and length vs constant power heaters (in particular 11 mm diameter also for class II elements)
- No cold lengths (differently from constant power heaters which require not heating zones for the thermostat and the thermofuse)
- Better circulation and faster heat-up times
- Absolutely no noise due to cavitation effects
- Better duration thanks to the reduction of the PTC on/off phases.

ELECTRIC RESISTANCE R...II WITH CABLE, in stainless steel with special 3/8" connection and 1.5 m long cable to be connected to the electrical system. The terminal part can be rotated ± 90° to allow the electric cable to be directed directly towards the wall or to the side, where it connects better to the electrical socket (3/8" to 1/2" adapter included)

ELECTRIC RESISTANCE R...IIF WITH FASTON in stainless steel with 1/2" connection, without cable, is equipped with faston connectors for connecting the thermostat.

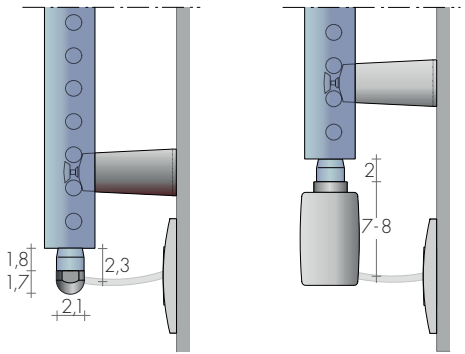

E.H.E. CLASS II

power absorbed	average consumption	ø3/8" with cable	ø1/2" with faston	PRICE
R.E. 250W	~0,19 KWH	Art. R250II	Art. R250IIF	101,10€
R.E. 300W	~0,225 KWH	Art. R300II	Art. R300IIF	102,20€
R.E. 400W	~0,30 KWH	Art. R400II	Art. R400IIF	103,40€
R.E. 500W	~0,375 KWH	Art. R500II	Art. R500IIF	105,60€
R.E. 650W	~0,49 KWH	Art. R650II	Art. R650IIF	107,80€
R.E. 800W	~0,60 KWH	Art. R800II	Art. R800IIF	112,60€
R.E. 900W	~0,675 KWH	Art. R900II	Art. R900IIF	116,20€
R.E. *1200W	~0,90 KWH	Art. R1200II	Art. R1200IIF	124,50€
R.E. *1500W	~1,125 KWH	Art. R1500II	Art. R1500IIF	135,40€

*Electric Heating Element working with constant power e.g. Average consumption 0,46/0,52 KWH (average 0,49KWH) per hour with 650W electric heater x cost of KWH in the bill

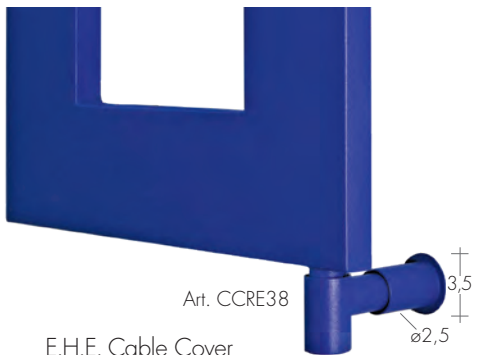

E.H.E. Cable Cover

Sleeve 3/8" Art. CCRE38 73,40€
Sleeve 1/2" Art. CCRE12 73,40€

The EU 2015/1188 ECODESIGN standard provides that electric towel heaters and radiators, in order to save energy, work with devices equipped with weekly programming, electronic temperature control and open window detector.

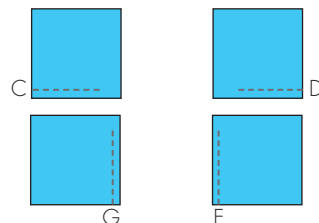

Electric Heating Element POSITION
 © Horizontal E.H.E. (on request in D)
 © Vertical E.H.E. (on request in E)
 To verify for each model

WARNINGS

TOWEL HEATERS WITH CLASS II ELECTRIC HEATING ELEMENT CAN BE INSTALLED INSIDE SPACE 2, WITH CABLE INSIDE SPACE 3



MIXED TOWEL HEATERS & RADIATORS

ARTICLES FOR MIXED VERSIONS

By applying an electric resistance to the Brem towel warmers, they heat the rooms in the intermediate seasons when the centralized system is off (hydraulic and electric operation).

The application of the electric heating element is thanks to:

- \varnothing 3/8" special sleeve welded on the return tube
- or \varnothing 1/2" sleeve for digital thermostat
- chrome plated TR accessory mounted on the return tube
- using the mixed valve for the connection

Art. M38	24,00€
Art. M12	24,00€
Art. TR	24,00€

MIXED VERSIONS with SLEEVE

Put the \varnothing 3/8" or \varnothing 1/2" sleeve for the electric heating element on the return manifold

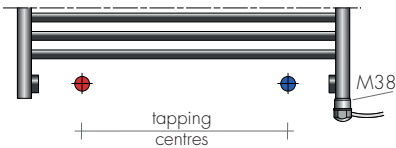

MIXED VERSIONS with TR Accessory

The tapping centres are reduced by 8 cm

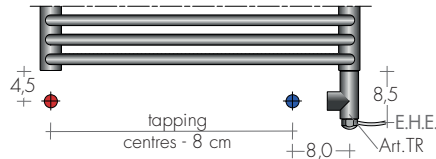

LAME Mixed versions

MIXED VERSIONS WITH MIXED VALVES

BREM offers a side control valve, complete with a \varnothing 1/2" fitting for the electrical heating element, to be installed on the right manifold of the return.

Using the mixed valve results in an increase in depth from the wall of 2cm.



UNI PLATT Mixed Quadra valve with thermostat

VALVES TON CHROME MIXED

TON side control, with fitting and round washer	Art.	multilayer	copper
		€	€
side control (S) delivery	LS..	65,90	63,60
TON side control MIXED (D)	LXD..	103,70	101,30
KIT TON MIXED	KLXD	188,20	

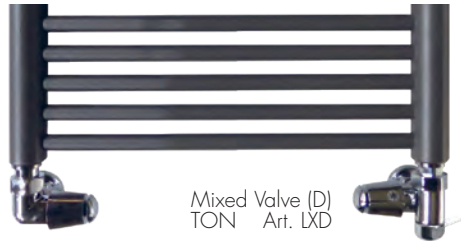

Mixed Valve (D)
TON Art. LXD

VALVE CYL CHROME MIXED LOCKSHIELD

CYL side control, with fitting and round washer	Art.	multilayer	copper
		€	€
side control (S) (delivery)	CLS..	85,30	82,90
CYL lockshield MIXED (D)	CYLXD	98,20	95,80
KIT CYL MIXED	KCLXD	202,10	

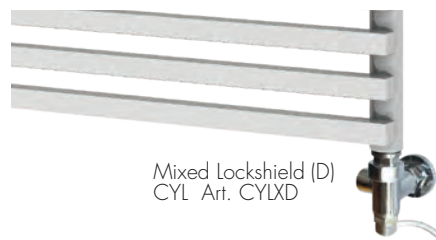

Mixed Lockshield (D)
CYL Art. CYLXD



START Mixed version

VALVE QUADRA CHROME MIXED

QUADRA side control, with fitting and round washer	Art.	multilayer	copper
		€	€
side control (S) (delivery)	QLS..	86,40	84,00
QUADRA MIXED (D)	QLXD..	112,00	109,80
KIT QUADRA MIXTE	KQLX	220,30	



Mixed Valve (D)
QUADRA Art. QLXD



UNI PLATT Mixed Quadra valve

THE RESISTANCE MUST WORK CONNECTED TO A THERMOSTAT compliant with ECODESIGN STANDARDS (pages 208-209)

KIT RE and Wi-Fi THERMOSTATS

RE KIT ELECTRIC HEATING ELEMENT with CABLE

- RE KIT with:
- Class II Electric Heating Element $\varnothing 1/2"$ with adjustable cable ($\pm 90^\circ$)
 - Filling with diathermic liquid and test
 - Chrome-plated plugs and brackets for wall fixing

KIT RE	cl.II with Electric Heating Element	250W	Art.	R250IIE	191,90€
KIT RE	cl.II with Electric Heating Element	300W	Art.	R300IIE	193,80€
KIT RE	cl.II with Electric Heating Element	400W	Art.	R400IIE	195,70€
KIT RE	cl.II with Electric Heating Element	500W	Art.	R500IIE	208,50€
KIT RE	cl.II with Electric Heating Element	650W	Art.	R650IIE	222,90€
KIT RE	cl.II with Electric Heating Element	800W	Art.	R800IIE	240,50€
KIT RE	cl.II with Electric Heating Element	900W	Art.	R900IIE	255,30€
KIT RE*	cl.II with Electric Heating Element	1200W	Art.	R1200IIE	276,30€
KIT RE*	cl.II with Electric Heating Element	1500W	Art.	R1500IIE	298,00€

*Electric heating element working with constant power



E.H.E. Cable Cover
Sleeve 3/8" Art. CCRE38 73,40€
Sleeve 1/2" Art. CCRE12 73,40€

THE HEATER MUST WORK CONNECTED TO A THERMOSTATIC CONTROL

KIT RT-WIFI

TR-WIFI is a wifi system with a single-zone thermostat, gateway and receiver that allows you to turn on, turn off and program up to 6 electric towel warmers directly or via wifi with the free dedicated App.

The RTWIFI Kit includes:

- Thermostat (battery operated)
- Built-in receiver
- Gateway Art. KITRT-wifi 199,80€

Additional receiver for electric radiators and split AC: 1 for each electrical radiator (up to 6) Art. SA868 64,20€

THERMOSTATS WiFi

compiants with ECODESIGN standards



FREE APP
SALUS RT310i

FEATURES

- Switching volt free and 230V
- Optional control via Smartphone, Tablet or PC
- Easy to use App
- Pre-paired wireless communication, so no more dip switches!
- Wall or desk mounted thermostat
- Choose to use schedule or control manually
- Adjustable frost protection when the thermostat is off
- Wireless communication test function
- Suitable for heating or cooling applications

OPTIONAL

On wall box for receiver

Art. SUNI 19,90€ 8,4 x 8,4 x 2,8 cm



RT-WIFI PROGRAMS

- Daily program for the entire week (every day is the same)
- Program for weekdays and weekends (5/2)
- Daily program (every day is different)
- Vacation Mode Program stops the system, to resume the set program.

5 Year Warranty

KIT ELY-WIFI TOP DESIGN

KIT ELY-WIFI is a wifi system with a single-zone thermostat advanced area for heating and cooling systems that allows you to manage the climate of your home with ease and comfort; controls up to 16 electric radiators.

Art. KITELY-wifi 396,10€

KIT ELY TOP Design includes:

- Thermostat with magnetic charging base and magnetic plate for wall mounting
- Rechargeable Li-ion battery with wireless recharging.
- Gateway a 230V
- Receiver (Relay)

Additional receiver for electric radiators and (split AC): 1 for each electrical device (up to 16) Art. SA600 99,10€



KIT ELY TOP DESIGN WIFI

Modern design with a metallic ring and negative display. WiFi setup via Bluetooth. Controls heating and cooling via app or locally. Energy optimisation features. Zigbee 2.4 GHz communication.



App: Salus Premium Lite

GOOGLE Assistance

COMPATIBLE with: alexa



KIT RT and THERMOSTATS ON THE RADIATOR

RT KIT ELECTRIC HEATING ELEMENT with FASTON

- RT KIT with:
- Class II Electric Heating Element (double protection) $\varnothing 1/2"$ with Faston
 - Filling with diathermic liquid and test
 - Chrome-plated plugs and brackets for wall fixing

KIT RT	cl.II with Electric Heating Element	250W	Art.	R250IIT	191,90€
KIT RT	cl.II with Electric Heating Element	300W	Art.	R300IIT	193,80€
KIT RT	cl.II with Electric Heating Element	400W	Art.	R400IIT	195,70€
KIT RT	cl.II with Electric Heating Element	500W	Art.	R500IIT	208,50€
KIT RT	cl.II with Electric Heating Element	650W	Art.	R650IIT	222,90€
KIT RT	cl.II with Electric Heating Element	800W	Art.	R800IIT	240,50€
KIT RT	cl.II with Electric Heating Element	900W	Art.	R900IIT	255,30€
KIT RT*	cl.II with Electric Heating Element	1200W	Art.	R1200IIT	276,30€
KIT RT*	cl.II with Electric Heating Element	1500W	Art.	R1500IIT	298,00€

*Electric heating element working with constant power

THE HEATER MUST WORK CONNECTED TO A THERMOSTATIC CONTROL

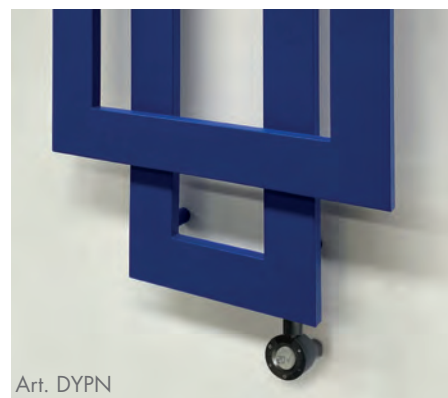

Art. DYPN

THERMOSTATS on the RADIATOR

compiants with ECODESIGN standards

THERMOSTAT DYP

DYNAMIC PRO is a white or black digital chronothermostat that can be positioned on the right or left of the towel warmer; 90 cm cable and with 2.5 cm adjustable cable cover.

* possible sleeve for the E.H.E.
(check the drawings of each model)

- White thermostat with white cable cover adjustable in depth

Art. DYPB 89,60€

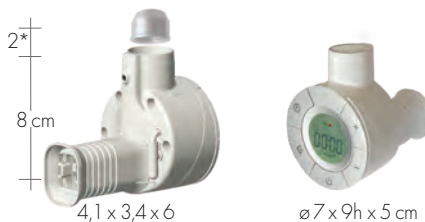

Art. DYPB

- Black thermostat, complete with black cable cover

Art. DYPN 103,40€



Art. DYPN

REMOTE CONTROL for DYP Thermostats

10,8 x 5,3x 2,3 cm

Infrared remote control with display and wall mounting support (magnetic coupling) is equipped with double transmitter and presence sensor

Art. TIR 41,00€



CIRCLE Wi-Fi THERMOSTAT (up to 800w heating elements)

The innovative Wifi user interface allows the control of the towel warmers with a dedicated App from a device such as a tablet or a smartphone with both Android and iOS operating systems.
80 cm cable length

- Chrome and glossy black finish Art. CIR-wifi 198,50€



Art. CIR chrome and glossy black

e.ALIS-ONE

TECHNICAL DATA p. 52
ELECTRIC KIT DATA p. 208-209



MODEL	H - L cm	Standard white sablé SB 9016 €	BREM Colors		KIT HEATING ELEMENT with:		
			+15% €	+25% €	Cable R...E Art. (W)	Faston R...T Art. (W)	€
ALIS-ONE	56-51	546,60	628,60	683,30	R300IIE	R300IIT	193,80
ALIS-ONE	56-91	640,00	736,00	800,00	R500IIE	R500IIT	208,50
ALIS-ONE	56-121	710,10	816,60	887,60	R650IIE	R650IIT	222,90
ALIS-ONE	70-51	586,00	673,90	732,50	R400IIE	R400IIT	195,70
ALIS-ONE	98-51	664,80	764,50	831,00	R500IIE	R500IIT	208,50
ALIS-ONE	126-51	743,70	855,30	929,60	R650IIE	R650IIT	222,90
ALIS-ONE	154-51	822,50	945,90	1028,10	R800IIE	R800IIT	240,50
ALIS-ONE	182-51	901,40	1036,60	1126,80	R900IIE	R900IIT	255,30

HEATING ELEMENT POSITION
© Vertical Heating Element

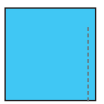

G

THERMOSTATS Wi-Fi FOR KIT RE P. 208

ACCESSORIES FOR

E.H.E. white cable cover
or radiator color (together)
Art.CCRE38 ø3/8" 73,40€
Art.CCRE12 ø1/2" 73,40€



The KIT RT Wi-Fi includes:
- Thermostat RT (battery)
- Gateway
- Built-in receiver

Art. KITRT-wifi 199,80€

Additional receiver
(up to 6) radiators)



Art. SA868 64,20€

KIT ELY Wi-Fi TOP DESIGN includes:
- Thermostat with magnetic charging base
and magnetic plate for wall mounting
- Gateway a 230V
- Built-in Receiver

Art. KITELY-wifi 396,10€

Additional receiver: 1 for each electrical radiators
or split AC (up to 16) Art. SA600 99,10€



e.ASYMM e.ASYMP

design Luigi Brembilla

TECHNICAL DATA p. 54
ELECTRIC KIT DATA p. 208-209

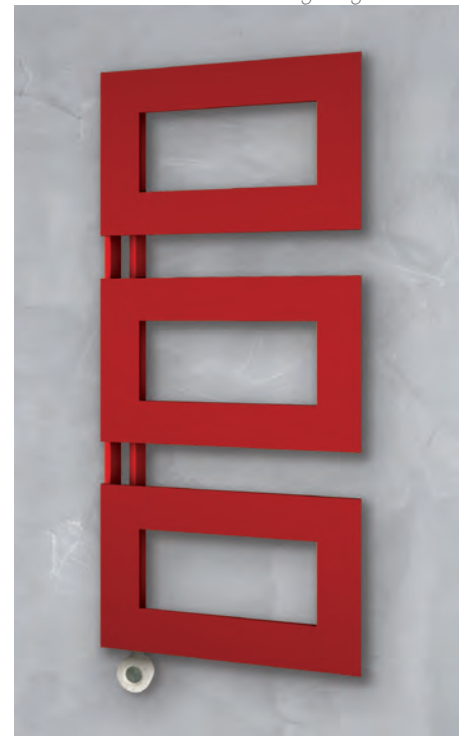
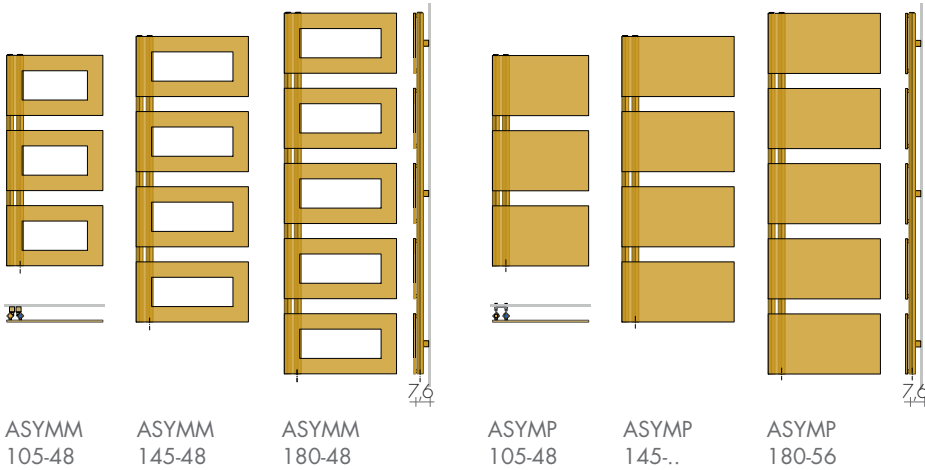

MODEL	H - L cm	Standard white	BREM Colors		KIT HEATING ELEMENT with:		
		sablé SB 9016 €	+15% €	+25% €	Cable R...E Art. (W)	Faston R...T Art. (W)	€
ASYMM	105-48	695,30	799,60	869,10	R500IIE	R500IIT	208,50
ASYMM	145-48	841,60	967,80	1052,00	R650IIE	R650IIT	222,90
ASYMM	180-48	963,30	1107,80	1204,10	R900IIE	R900IIT	255,30
ASYMP	105-48	831,00	955,70	1038,80	R650IIE	R650IIT	222,90
ASYMP	145-48	1018,00	1170,70	1272,50	R800IIE	R800IIT	240,50
ASYMP	145-56	1059,00	1217,90	1323,80	R900IIE	R900IIT	255,30
ASYMP	180-56	1180,70	1357,80	1475,90	R1200IIE	R1200IIT	276,30

HEATING ELEMENT POSITION
E Vertical Heating Element

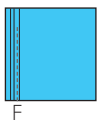

ELECTRIC VERSIONS

THERMOSTATS ON THE RADIATOR FOR KIT RT P. 209

THERMOSTAT mod. DYP



White with
white cable cover
Art. DYPB 89,60€

ø 7 x 9 x 5 cm



Black with
black cable cover
Art. DYPN 103,40€

REMOTE CONTROL for thermostats DYP

10,8 x 5,3 x 2,3 cm



Art. TIR 41,00€

THERMOSTAT CIRCLE Wi-Fi
up to 800 W
heating elements



ø 6 x 8 x 5 cm



Chrome/Black finish
Art. CIR-wifi 198,50€



ELECTRIC



e.CAMEO

design Davide Diliberto

TECHNICAL DATA p. 120
ELECTRIC KIT DATA p. 208-209

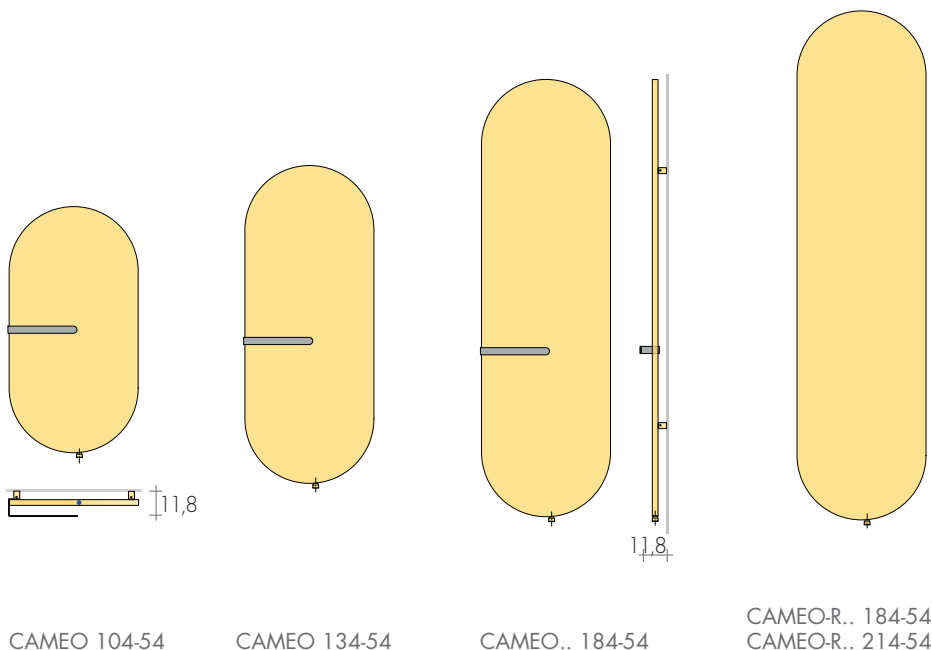

MODEL	H - L cm	Standard white	BREM Colors		KIT HEATING ELEMENT with:		
		sablé SB 9016 €	+15% €	+25% €	Cable R...E Art. (W)	Faston R...T Art. (W)	€
CAMEO 104-54	104,54	1049,30	1206,70	1311,60	R500IIE	R500IIT	208,50
CAMEO 134-54	134,54	1170,30	1345,80	1462,90	R650IIE	R650IIT	222,90
CAMEO 184-54	134,54	1342,40	1543,80	1678,00	R900IIE	R900IIT	255,30
CAMEO-L 184-54	158,54	1585,80	1823,70	1982,30	R1200IIE	R1200IIT	276,30
Models without towel bar - RADIATORS							
CAMEO-R 184-54	128,54	1281,50	1473,70	1601,90	R900IIE	R900IIT	255,30
CAMEO-RL 184-54	152,54	1524,90	1753,60	1906,10	R1200IIE	R1200IIT	276,30
CAMEO-R 214-54	138,54	1382,20	1589,50	1727,80	R1200IIE	R1200IIT	276,30
CAMEO-RL 214-54	182,54	1822,70	2096,10	2278,40	R1500IIE	R1500IIT	298,00

Towel bar on the right side, on request without extra

TOWEL BAR CAMEO: STANDARD COLORS
- white sablé SB 9016 - quartz grey SB 7039
- black sablé SB 9005 - same color as the radiator

Additional or deductible towel bar CAMEO
Art. MCA 60,90€

In one paintwork to Brem color list different from the radiator
Extra Art. CM 52,90€

HEATING ELEMENT POSITION
© Vertical Heating Element

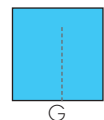

THERMOSTATS Wi-Fi FOR KIT RE P. 208

ACCESSORIES FOR



The KIT RT Wi-Fi includes:
- Thermostat RT (battery)
- Gateway
- Built-in receiver

Art. KITRT-wifi 199,80€

Additional receiver
(up to 6) radiators)



Art. SA868 64,20€

KIT ELY Wi-Fi TOP DESIGN includes:
- Thermostat with magnetic charging base and magnetic plate for wall mounting
- Gateway a 230V
- Built-in Receiver

Art. KITELY-wifi 396,10€

Additional receiver: 1 for each electrical radiators or split AC (up to 16)
Art. SA600 99,10€



e.CANNUCCIA STRAW

design Bettazzi+Percoco Architects

TECHNICAL DATA
and other dimensions p.168
ELECTRIC KIT DATA p. 208-209

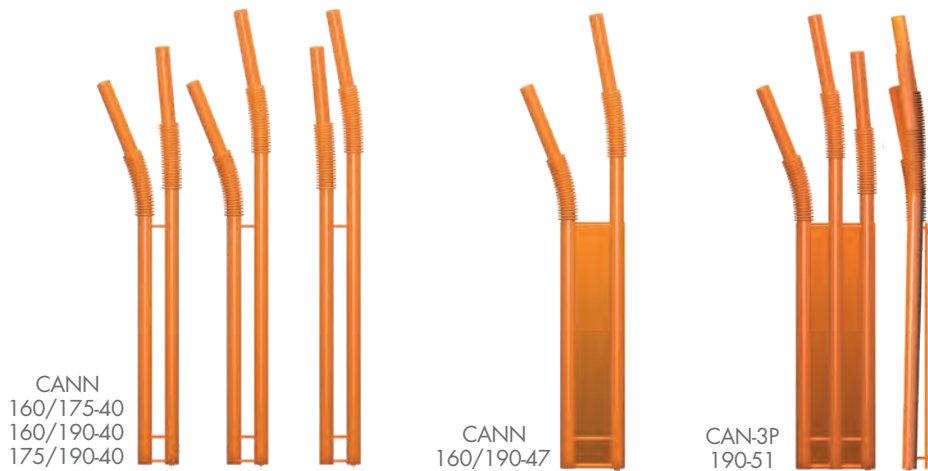
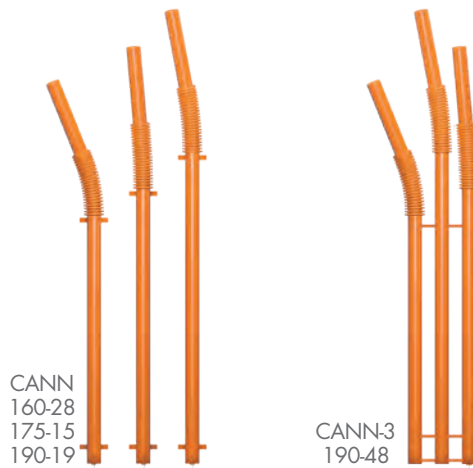

MODEL (STRAW)	H - L cm	Standard white	BREM Colors	BREM Colors	KIT HEATING ELEMENT with:		
		sablé SB 9016 €	+15% €	+25% €	Cable R...E Art. (W)	Faston R...T Art. (W)	€
CANN	160-28	602,60	693,00	753,30	R250IIE	R250IIT	191,90
CANN	175-15	624,50	718,20	780,60	R250IIE	R250IIT	191,90
CANN	190-19	646,20	743,10	807,80	R250IIE	R250IIT	191,90
CANN 160/175-40		973,60	1119,60	1217,00	R300IIE	R300IIT	193,80
CANN 160/190-40		995,20	1144,50	1244,00	R300IIE	R300IIT	193,80
CANN 175/190-27		1017,00	1169,60	1271,30	R400IIE	R400IIT	195,70
CANN-3	190-48	1293,70	1487,80	1617,10	R500IIE	R500IIT	208,50
CAN-P 160/190-47		1272,40	1463,30	1590,50	R650IIE	R650IIT	222,90
CAN-3P	190-51	1570,90	1806,50	1963,60	R800IIE	R800IIT	240,50

TOWEL BAR with wall fixings
(white or in the radiator color)

Art. MCA 30 84,60€ 30/15 cm (L/p)
Art. MCA 36 91,30€ 36/18 cm (L/p)



HEATING ELEMENT Position
©Vertical Heating Element

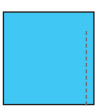

ELECTRIC VERSIONS

THERMOSTATS IN THE RADIATOR FOR KIT RT P. 209

THERMOSTAT mod. DYP



White with
white cable cover
Art. DYPB 89,60€

ø 7 x 9 x 5 cm



Black with
black cable cover
Art. DYPN 103,40€

REMOTE CONTROL for thermostats DYP

10,8 x 5,3 x 2,3 cm



Art. TIR 41,00€

THERMOSTAT CIRCLE Wi-Fi
up to 800 W
heating elements



ø 6 x 8 h x 5 cm



Chrome/Black finish
Art. CIR-wifi 198,50€



e.CHEM e.CHEM-M

design Davide Diliberto

TECHNICAL DATA and other dimensions p. 150, 170
ELECTRIC KIT DATA p. 208-209

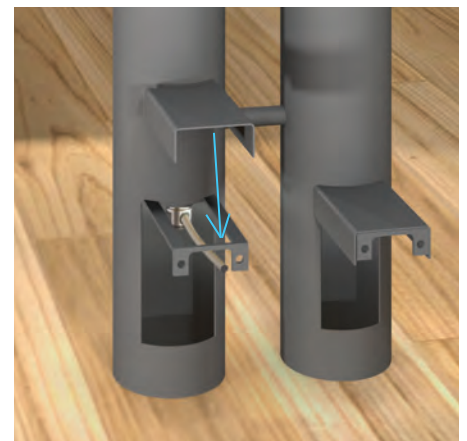
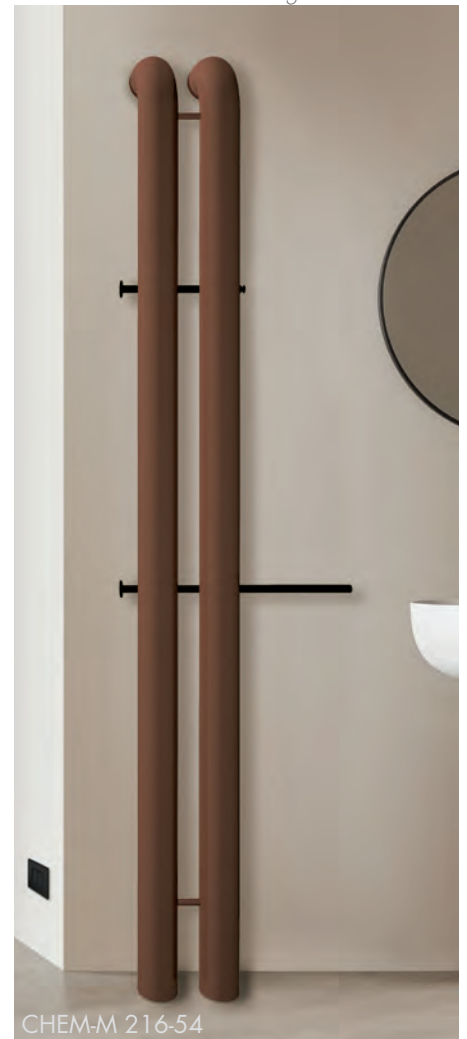
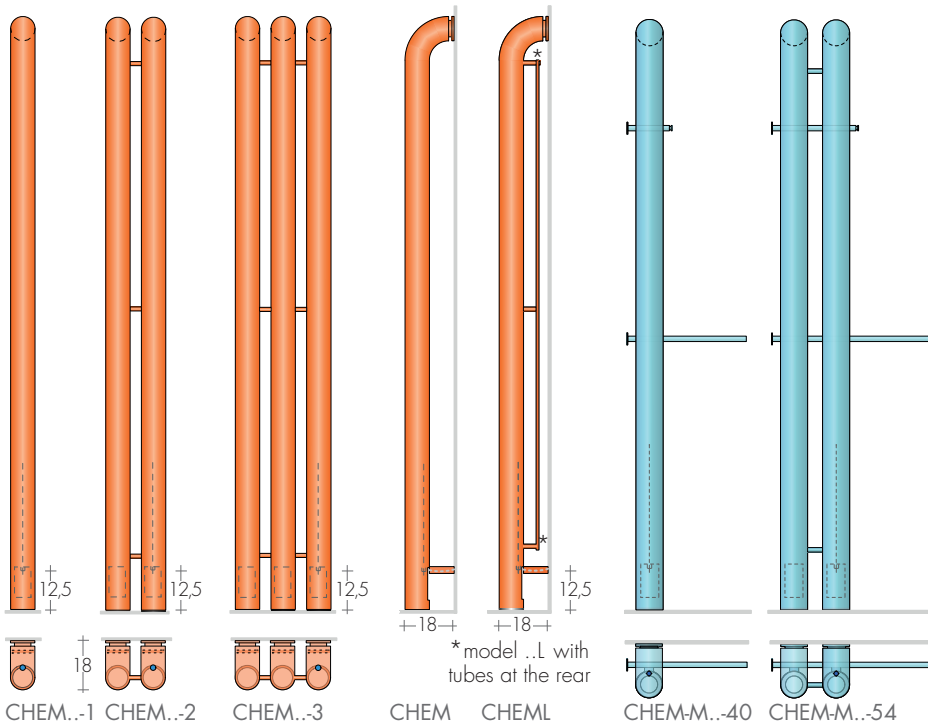

HEATING ELEMENT POSITION
© Vertical Heating Element

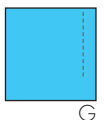

MODEL	H - L cm	Standard white	BREM Colors	BREM Colors	KIT HEATING ELEMENT with:		
		sablé SB 9016 €	+15% €	+25% €	Cable R..E Art. (W)	Faston R..T Art. (W)	€
CHEM	196-1	682,10	784,40	852,60	R300IIE	-	193,80
CHEM	196-2	917,30	1054,90	1146,60	R650IIE	-	222,90
CHEM	196-3	1152,50	1325,40	1440,60	R900IIE	-	255,30
CHEML	196-1	787,90	906,10	984,90	R500IIE	-	208,50
CHEML	196-2	1129,00	1298,40	1411,30	R900IIE	-	255,30
CHEML	196-3	1470,00	1690,50	1837,50	R1500IIE	-	276,00
CHEM	216-1	717,40	825,00	896,80	R400IIE	-	195,70
CHEM	216-2	970,30	1115,80	1212,90	R800IIE	-	240,50
CHEM	216-3	1223,00	1406,50	1528,80	R1200IIE	-	276,30
CHEML	216-1	827,90	952,10	1034,90	R500IIE	-	208,50
CHEML	216-2	1191,30	1370,00	1489,10	R1200IIE	-	276,30
CHEML	216-3	1554,70	1787,90	1943,40	R1500IIE	-	298,00
CHEM-M	196-40	752,60	865,50	940,80	R300IIE	-	193,80
CHEM-M	196-54	987,80	1136,00	1234,80	R650IIE	-	222,90
CHEM-M	216-40	787,90	906,10	984,90	R400IIE	-	195,70
CHEM-M	216-54	1040,80	1196,90	1301,00	R800IIE	-	240,50

CHEM-M, Towel holder and Knob
standard colors: white sablé SB 9016
quartz grey SB 7039 jet black SB 9005
Paintwork to Brem color list Extra Art. CM 52,90€

ONLY with Wi-Fi THERMOSTATS for KIT RE

THERMOSTATS Wi-Fi FOR KIT RE P. 208

E.H.E. white cable cover
integrated in the radiator bracket

The KIT RT Wi-Fi includes:
- Thermostat RT (battery)
- Gateway
- Built-in receiver

Art. KITRT-wifi 199,80€

Additional receiver
(up to 6) radiators)

Art. SA868 64,20€



KIT ELY Wi-Fi TOP DESIGN includes:
- Thermostat with magnetic charging base
and magnetic plate for wall mounting
- Gateway a 230V
- Built-in Receiver

Art. KITELY-wifi 396,10€

Additional receiver: 1 for each electrical radiators
or split AC (up to 16) Art. SA600 99,10€



ACCESSORIES FOR



e.CHEM-S

design Davide Diliberto

TECHNICAL DATA and other dimensions p. 172
ELECTRIC KIT DATA p. 208-209

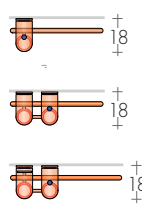

CHEM-S 196-50/..
216-50/..
CHEM-S 196D-50/..
216D-50/..
CHEM-S 216DL*60/..

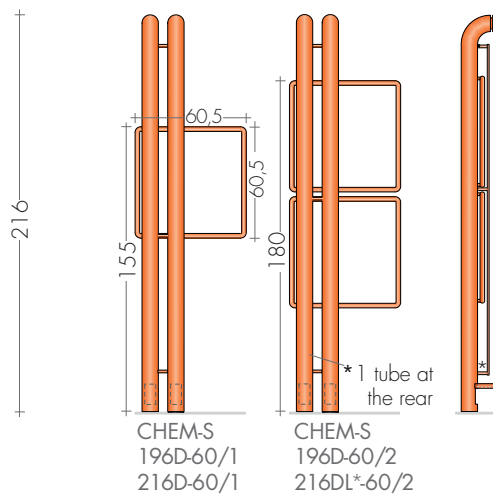
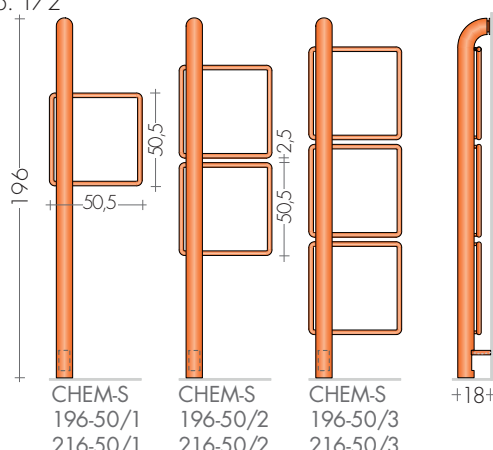

CHEM-S 216-50/2

MODEL	H - L cm	Standard white	BREM Colors		KIT HEATING ELEMENT with:		
		sablé SB 9016 €	+15% €	+25% €	Cable R...E Art. (WV)	Faston R...T Art. (WV)	€
CHEM-S 196-50/1	155	764,40	879,10	955,50	R400IIE	-	195,70
CHEM-S 196-50/2	170	858,50	987,30	1073,10	R500IIE	-	208,50
CHEM-S 196-50/3	180	952,60	1095,50	1190,80	R650IIE	-	222,90
CHEM-S 196D-50/1	155	999,60	1149,50	1249,50	R800IIE	-	240,50
CHEM-S 196D-50/2	170	1093,70	1257,80	1367,10	R900IIE	-	255,30
CHEM-S 196D-50/3	180	1187,80	1366,00	1484,80	R900IIE	-	255,30
CHEM-S 216-50/1	216	799,70	919,70	999,60	R500IIE	-	208,50
CHEM-S 216-50/2	216	893,80	1027,90	1117,30	R500IIE	-	208,50
CHEM-S 216-50/3	216	987,80	1136,00	1234,80	R650IIE	-	222,90
CHEM-S 216D-50/1	216	1034,90	1190,10	1293,60	R800IIE	-	240,50
CHEM-S 216D-50/2	216	1129,00	1298,40	1411,30	R900IIE	-	255,30
CHEM-S 216D-60/1	216	1059,50	1218,50	1324,40	R900IIE	-	255,30
CHEM-S 216DL-60/2	216	1331,50	1531,20	1664,40	R1200IIE	-	276,30

ONLY with Wi-Fi THERMOSTATS for KIT RE

HEATING ELEMENT POSITION
© Vertical Heating Element

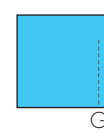

ELECTRIC VERSIONS

THERMOSTATS Wi-Fi FOR KIT RE P. 208

The KIT RT Wi-Fi includes:
- Thermostat RT (battery)
- Gateway
- Built-in receiver

Art. KITRT-wifi 199,80€



Additional receiver
(up to 6) radiators)

Art. SA868 64,20€

KIT ELY Wi-Fi TOP DESIGN includes:
- Thermostat with magnetic charging base
and magnetic plate for wall mounting
- Gateway a 230V
- Built-in Receiver

Art. KITELY-wifi 396,10€



Additional receiver: 1 for each electrical radiators
or split AC (up to 16) Art. SA600 99,10€

ELECTRIC



TECHNICAL DATA and other dimensions p. 86, 88
ELECTRIC KIT DATA p. 208-209

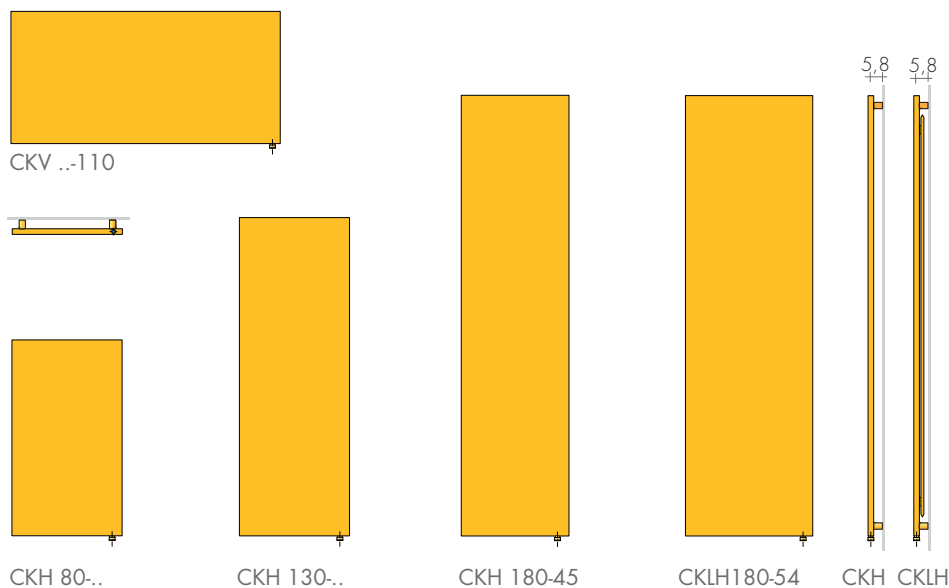

MODEL	H - L cm	Standard white	BREM Colors	BREM Colors	KIT HEATING ELEMENT with:		
		sablé SB 9016 €	+15% €	+25% €	Cable R..E Art. (W)	Faston R..T Art. (W)	€
CKV	45-110	1041,20	1197,40	1301,50	R500IIE	R500IIT	208,50
CKV	54-110	1110,20	1276,70	1387,80	R650IIE	R650IIT	222,90
CKH	80-45	788,30	906,50	985,40	R400IIE	R400IIT	195,70
CKH	80-54	866,10	996,00	1082,60	R500IIE	R500IIT	208,50
CKH	130-45	951,40	1094,10	1189,30	R650IIE	R650IIT	222,90
CKH	130-54	1040,00	1196,00	1300,00	R800IIE	R800IIT	240,50
CKH	180-36	1018,90	1171,70	1273,60	R800IIE	R800IIT	240,50
CKH	180-45	1114,40	1281,60	1393,00	R900IIE	R900IIT	255,30
CKLH	180-36	1319,40	1517,30	1649,30	R900IIE	R900IIT	255,30
CKLH	180-45	1430,50	1645,10	1788,10	R1200IIE	R1200IIT	276,30
CKLH	180-54	1566,70	1801,70	1958,40	R1500IIE	R1500IIT	298,00
CKH	200-54	1274,10	1465,20	1592,60	R1200IIE	R1200IIT	276,30
CKLH	200-54	1694,40	1948,60	2118,00	R1500IIE	R1500IIT	298,00

CLAK-FO/FA Gilded Leaf/Silver Leaf: Price x 1,9

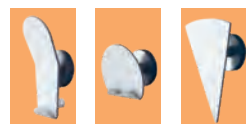

KNOBS with magnet
page 277

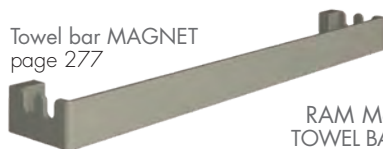

Towel bar MAGNET
page 277

RAM Magnetic
TOWEL BAR
page 277



HEATING ELEMENT POSITION
© Vertical Heating Element



THERMOSTATS Wi-Fi FOR KIT RE P. 208

ACCESSORIES FOR

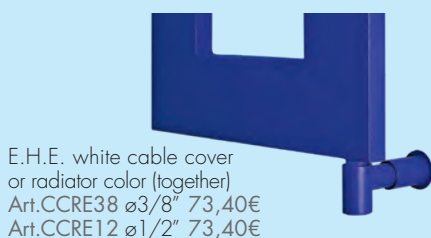

E.H.E. white cable cover
or radiator color (together)
Art.CCRE38 ø3/8" 73,40€
Art.CCRE12 ø1/2" 73,40€

The KIT RT Wi-Fi includes:
- Thermostat RT (battery)
- Gateway
- Built-in receiver

Art. KITRT-wifi 199,80€

Additional receiver
(up to 6) radiators)



Art. SA868 64,20€

KIT ELY Wi-Fi TOP DESIGN includes:
- Thermostat with magnetic charging base
and magnetic plate for wall mounting
- Gateway a 230V
- Built-in Receiver

Art. KITELY-wifi 396,10€

Additional receiver: 1 for each electrical radiators
or split AC (up to 16) Art. SA600 99,10€



TECHNICAL DATA and other dimensions p. 122
ELECTRIC KIT DATA p. 208-209

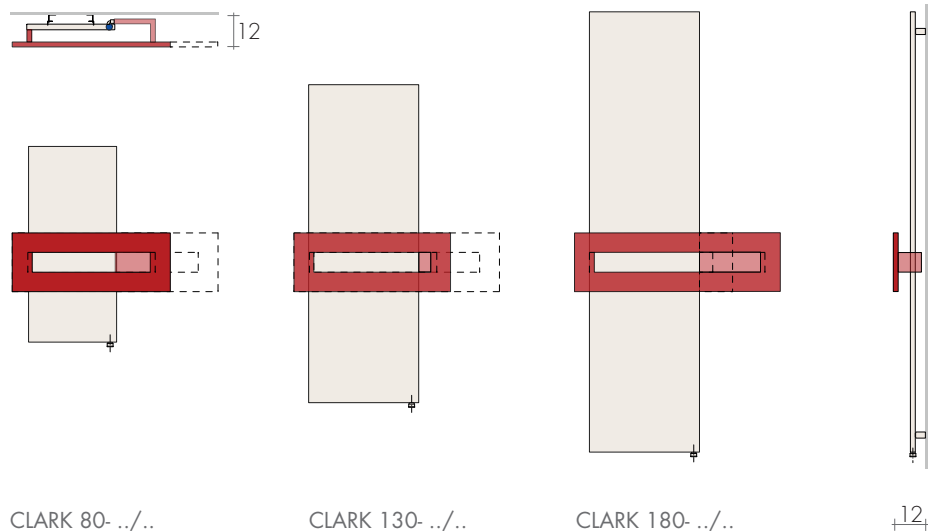

CLARK 80- ../..

CLARK 130- ../..

CLARK 180- ../..



HEATING ELEMENT POSITION
© Vertical Heating Element



MODEL	H - L cm	Standard white	BREM Colors	BREM Colors	KIT HEATING ELEMENT with:		
		sablé SB 9016 €	+15% €	+25% €	Cable R. E Art. (W)	Faston R. T Art. (W)	€
CLARK	80-36/64	1102,40	1267,80	1378,00	R500IIE	R500IIT	208,50
CLARK	80-45/84	1233,10	1418,10	1541,40	R650IIE	R650IIT	222,90
CLARK	130-36/64	1233,00	1418,00	1541,30	R650IIE	R650IIT	222,90
CLARK	130-45/84	1396,10	1605,50	1745,10	R800IIE	R800IIT	240,50
CLARK	180-36/64	1431,60	1646,30	1789,50	R900IIE	R900IIT	255,30
CLARK	180-45/84	1559,00	1792,90	1948,80	R1200IIE	R1200IIT	276,30

TOWEL BAR CLARK

STANDARD COLORS:
- white sablé SB9016
- grey sablé SB7039
- black sablé SB9005
- same color ordered with the radiator +15/25%
Paintwork to Brem color list Extra Art. CMC74,50€

ELECTRIC VERSIONS

THERMOSTATS IN THE RADIATOR FOR KIT RT P. 209

THERMOSTAT mod. DYP



White with
white cable cover
Art. DYPB 89,60€

ø 7 x 9 x 5 cm



Black with
black cable cover
Art. DYPN 103,40€

REMOTE CONTROL for thermostats DYP

10,8 x 5,3 x 2,3 cm



Art. TIR 41,00€

THERMOSTAT CIRCLE Wi-Fi up to 800 W heating elements



ø 6 x 8 x 5 cm



Chrome/Black finish
Art. CIR-wifi 198,50€



e.CROSS WITH CROSSED SQUARES

design Luigi Brembilla

TECHNICAL DATA and other dimensions p. 56
ELECTRIC KIT DATA p. 208-209

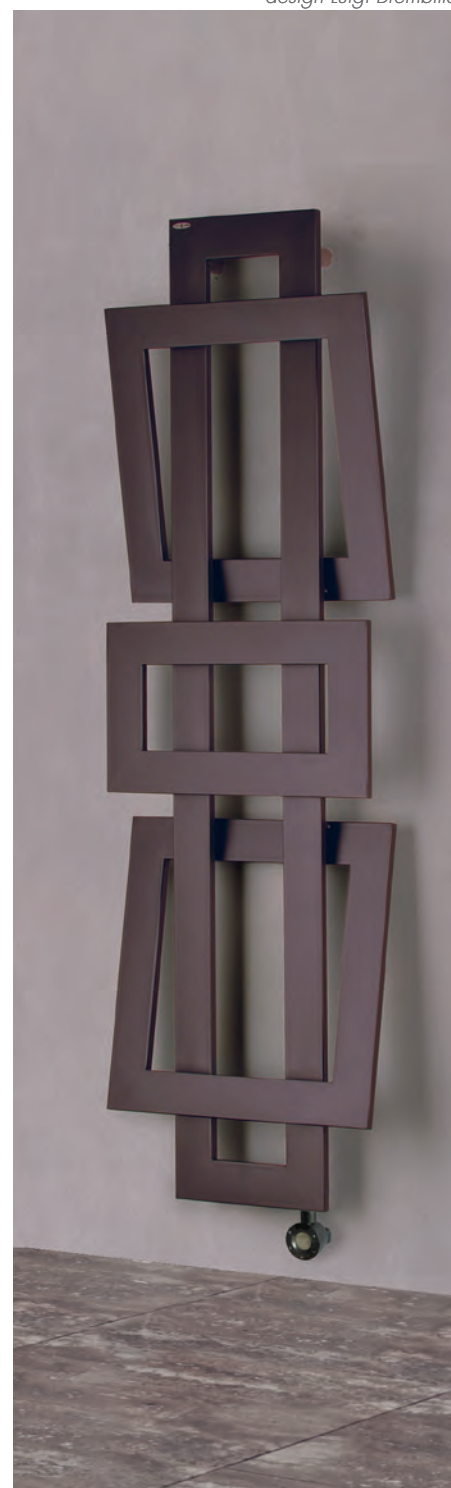
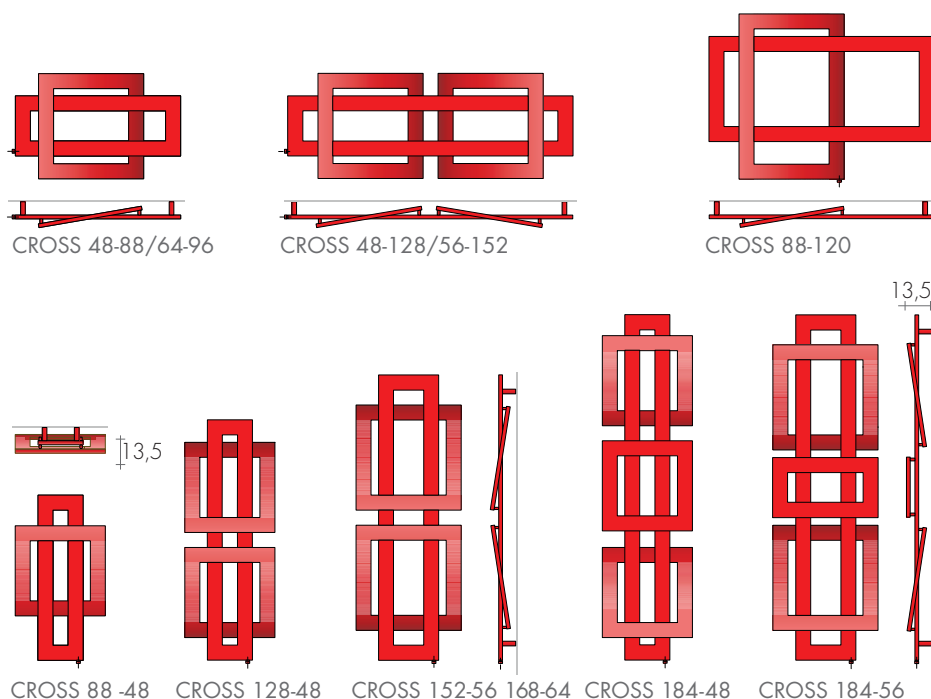

MODEL	H - L cm	Standard white	BREM Colors		KIT HEATING ELEMENT with:		
		sablé SB 9016 €	+15% €	+25% €	Cable R...E Art. (W)	Faston R...T Art. (W)	€
CROSS 48-88	48-88	768,20	883,40	960,30	R400IIE	R400IIT	195,70
CROSS 48-128	48-128	1066,50	1226,50	1333,10	R650IIE	R650IIT	222,90
CROSS 56-152	56-152	1156,10	1329,50	1445,10	R800IIE	R800IIT	240,50
CROSS 64-96	64-96	867,60	997,70	1084,50	R500IIE	R500IIT	208,50
CROSS 88-48	88-48	754,00	867,10	942,50	R400IIE	R400IIT	195,70
CROSS 88-120	88-120	939,50	1080,40	1174,40	R650IIE	R650IIT	222,90
CROSS 128-48	128-48	1058,30	1217,00	1322,90	R650IIE	R650IIT	222,90
CROSS 152-56	152-56	1146,10	1318,00	1432,60	R800IIE	R800IIT	240,50
CROSS 168-64	168-64	1224,90	1408,60	1531,10	R900IIE	R900IIT	255,30
CROSS 184-48	184-48	1375,70	1582,10	1719,60	R900IIE	R900IIT	255,30
CROSS 184-56	184-56	1434,70	1649,90	1793,40	R900IIE	R900IIT	255,30

HEATING EL. POSITION
 ☉ Horizontal Heating El.
 ☉ Vertical Heating El.

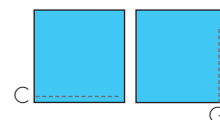

THERMOSTATS Wi-Fi FOR KIT RE P. 208

ACCESSORIES FOR

E.H.E. white cable cover
or radiator color (together)
Art.CCRE38 ø3/8" 73,40€
Art.CCRE12 ø1/2" 73,40€



The KIT RT Wi-Fi includes:
 - Thermostat RT (battery)
 - Gateway
 - Built-in receiver

Art. KITRT-wifi 199,80€

Additional receiver
(up to 6) radiators)



Art. SA868 64,20€

KIT ELY Wi-Fi TOP DESIGN includes:
 - Thermostat with magnetic charging base
and magnetic plate for wall mounting
 - Gateway a 230V
 - Built-in Receiver

Art. KITELY-wifi 396,10€

Additional receiver: 1 for each electrical radiators
or split AC (up to 16) Art. SA600 99,10€



e.CROSS-CROM WITH OVERLAPPING SQUARES

e.CROSS-FO/FA GILDED/SILVER LEAF

design Luigi Brembilla

TECHNICAL DATA and other dimensions p. 63
ELECTRIC KIT DATA p. 208-209

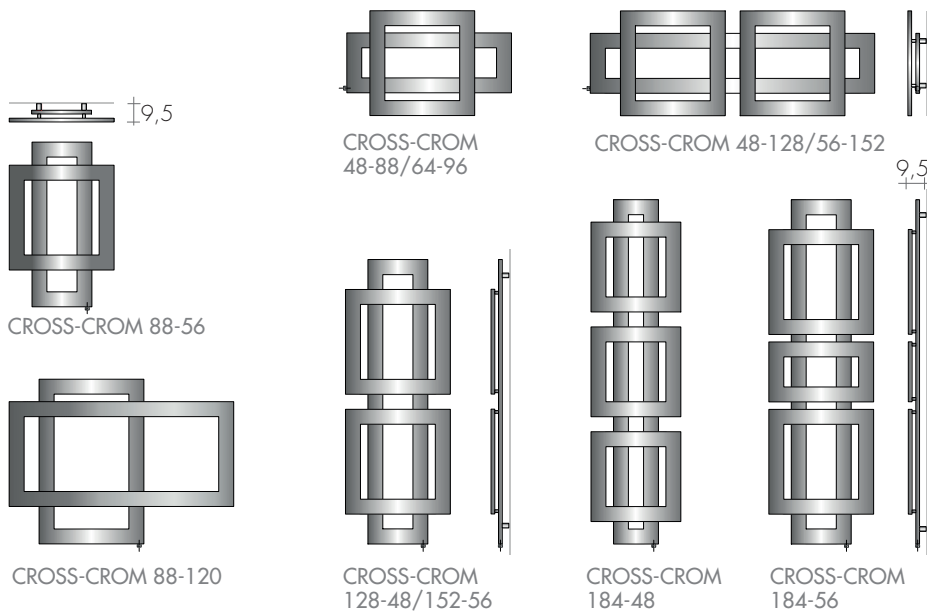

MODEL WITH OVERLAPPING SQUARES	H-L cm	Chrome-plated standard €
Cross CROM 48-88	48-88	1790,00
Cross CROM 48-128	48-128	2484,90
Cross CROM 56-152	56-152	2693,70
Cross CROM 64-96	64-96	2021,70
Cross CROM 88-56	88-56	1828,50
Cross CROM 88-120	88-120	2188,40
Cross CROM 128-48	128-48	2465,20
Cross CROM 152-56	152-56	2670,40
Cross CROM 184-48	184-48	3543,90
Cross CROM 184-56	184-56	3695,80

KIT HEATING ELEMENT with:		
Cable R...E Art. (W)	Faston R...T Art. (W)	€
R300IIE	R300IIT	193,80
R500IIE	R500IIT	208,50
R650IIE	R650IIT	222,90
R400IIE	R400IIT	195,70
R500IIE	R500IIT	208,50
R500IIE	R500IIT	208,50
R650IIE	R650IIT	222,90
R800IIE	R800IIT	240,50
R900IIE	R900IIT	255,30

MODEL WITH OVERLAPPING SQUARES	H-L cm	Gilded/Silver leaf €
Cross FO/FA 48-88	48-88	2151,20
Cross FO/FA 48-128	48-128	2986,00
Cross FO/FA 64-96	64-96	2429,10
Cross FO/FA 88-48	88-48	2111,00
Cross FO/FA 88-120	88-120	2284,70
Cross FO/FA 128-48	128-48	2630,20
Cross FO/FA 152-56	152-56	3093,10
Cross FO/FA 168-64	168-64	3209,40
Cross FO/FA 184-48	184-48	3348,70
Cross FO/FA 184-56	184-56	3492,50

KIT HEATING ELEMENT with:		
Cable R...E Art. (W)	Faston R...T Art. (W)	€
R400IIE	R400IIT	195,70
R650IIE	R650IIT	222,90
R500IIE	R500IIT	208,50
R400IIE	R400IIT	195,70
R650IIE	R650IIT	222,90
R650IIE	R650IIT	222,90
R800IIE	R800IIT	240,50
R900IIE	R900IIT	255,30
R900IIE	R900IIT	255,30
R900IIE	R900IIT	255,30

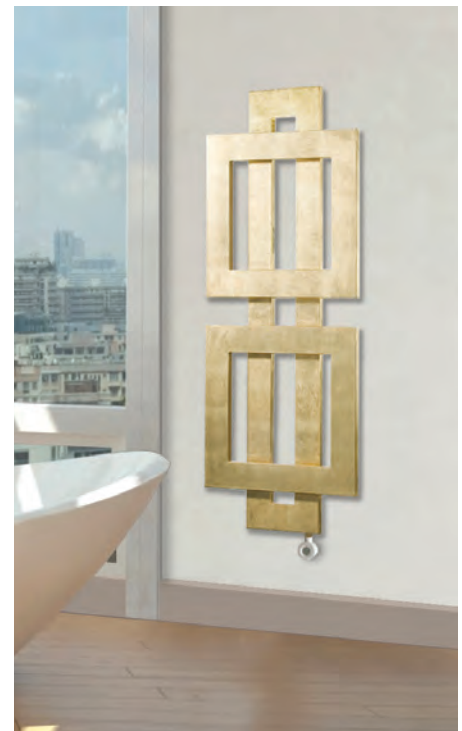

HEATING EL. POSITION
 ☉ Horizontal Heating El.
 ☉ Vertical Heating El.

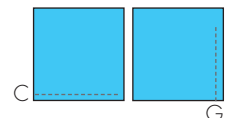

ELECTRIC VERSIONS

THERMOSTATS IN THE RADIATOR FOR KIT RT P. 209

THERMOSTAT mod. DYP



White with white cable cover
Art. DYPB 89,60€

ø 7 x 9 x 5 cm



Black with black cable cover
Art. DYPN 103,40€

REMOTE CONTROL for thermostats DYP

10,8 x 5,3 x 2,3 cm



Art. TIR 41,00€

THERMOSTAT CIRCLE Wi-Fi
up to 800 W heating elements



ø 6 x 8 x 5 cm



Chrome/Black finish
Art. CIR-wifi 198,50€



e.CROSS-G - e.CROSS-V

TECHNICAL DATA and other dimensions
 CROSS-G page 46, CROSS-V page 50
 ELECTRIC KIT DATA page 208-209

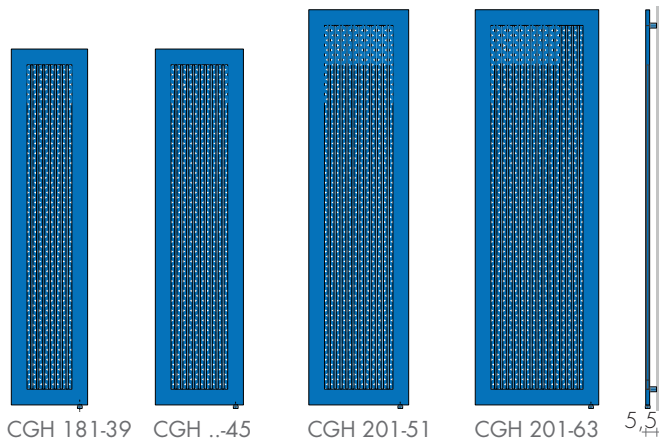

CGH 181-39 CGH ...45 CGH 201-51 CGH 201-63 5,5

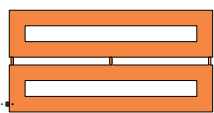

CROSS-2V 52-104



CROSS-V 52-144

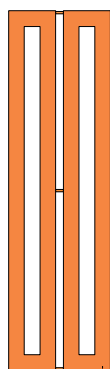

CROSS-..V ...52

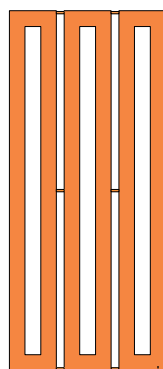

CROSS-V ...80

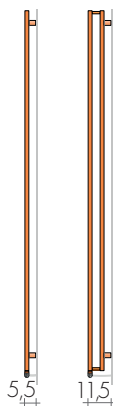

CROSS-V ...2V

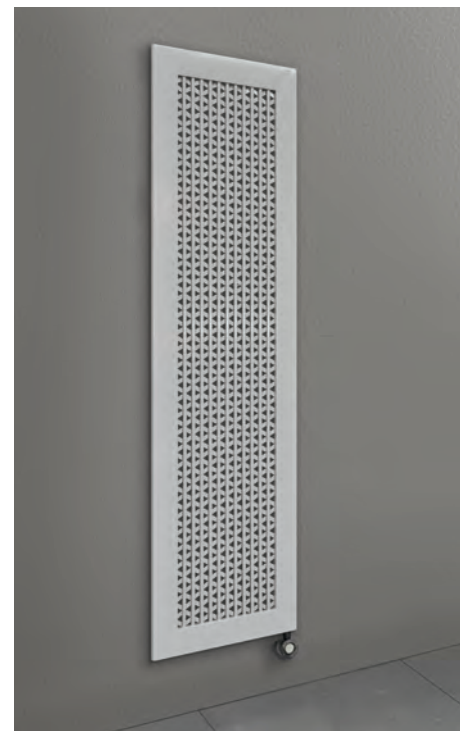

MODEL	H - L cm	Standard white sablé SB 9016 €	BREM Colors		KIT HEATING ELEMENT with:		
			+15% €	+25% €	Cable R...E Art. (W)	Faston R...T Art. (W)	€
CGH 181-39	181-39	1159,20	1333,10	1449,00	R800IIE	R800IIT	240,50
CGH 181-45	181-45	1216,30	1398,70	1520,40	R900IIE	R900IIT	255,30
CGH 201-45	201-45	1284,20	1476,80	1605,30	R900IIE	R900IIT	255,30
CGH 201-51	201-51	1341,40	1542,60	1676,80	R1200IIE	R1200IIT	276,30
CGH 201-63	201-63	1455,90	1674,30	1819,90	R1500IIE	R1500IIT	298,00
CROSS-V 52-144	52-144	772,20	888,00	965,30	R650IIE	R650IIT	222,90
CROSS-2V 52-104	52-104	1140,80	1311,90	1426,00	R900IIE	R900IIT	255,30
CROSS-2V 52-144	52-144	1467,00	1687,10	1833,80	R1200IIE	R1200IIT	276,30
CROSS-V 184-52	184-52	1059,20	1218,10	1324,00	R900IIE	R900IIT	255,30
CROSS-V 184-80	184-80	1465,30	1685,10	1831,60	R1200IIE	R1200IIT	276,30
CROSS-V 208-80	208-80	1512,60	1739,50	1890,80	R1500IIE	R1500IIT	298,00
CROSS-2V 184-52	184-52	1059,20	1218,10	1324,00	R1500IIE	R1500IIT	298,00

Other sizes on request

HEATING EL. POSITION
 ☉ Horizontal Heating El.
 ☉ Vertical Heating El.

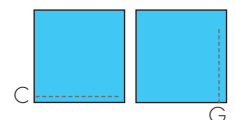

THERMOSTATS Wi-Fi FOR KIT RE P. 208

ACCESSORIES FOR



E.H.E. white cable cover
 or radiator color (together)
 Art.CCRE38 ø3/8" 73,40€
 Art.CCRE12 ø1/2" 73,40€

The KIT RT Wi-Fi includes:
 - Thermostat RT (battery)
 - Gateway
 - Built-in receiver

Art. KITRT-wifi 199,80€

Additional receiver
 (up to 6) radiators)



Art. SA868 64,20€

KIT ELY Wi-Fi TOP DESIGN includes:
 - Thermostat with magnetic charging base
 and magnetic plate for wall mounting
 - Gateway a 230V
 - Built-in Receiver

Art. KITELY-wifi 396,10€

Additional receiver: 1 for each electrical radiators
 or split AC (up to 16) Art. SA600 99,10€



e.CROSS-Q WITH OVERLAPPING SQUARES

design Luigi Brembilla

TECHNICAL DATA and other dimensions p. 60
ELECTRIC KIT DATA p. 208-209

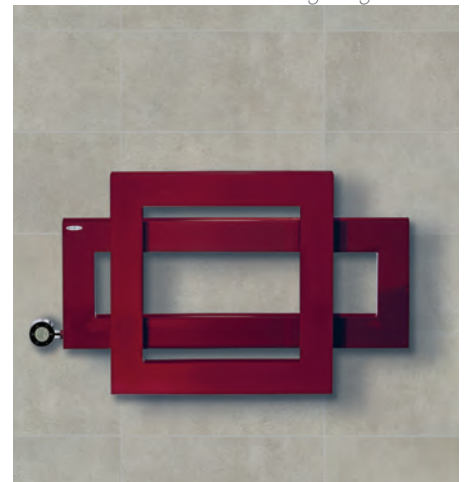
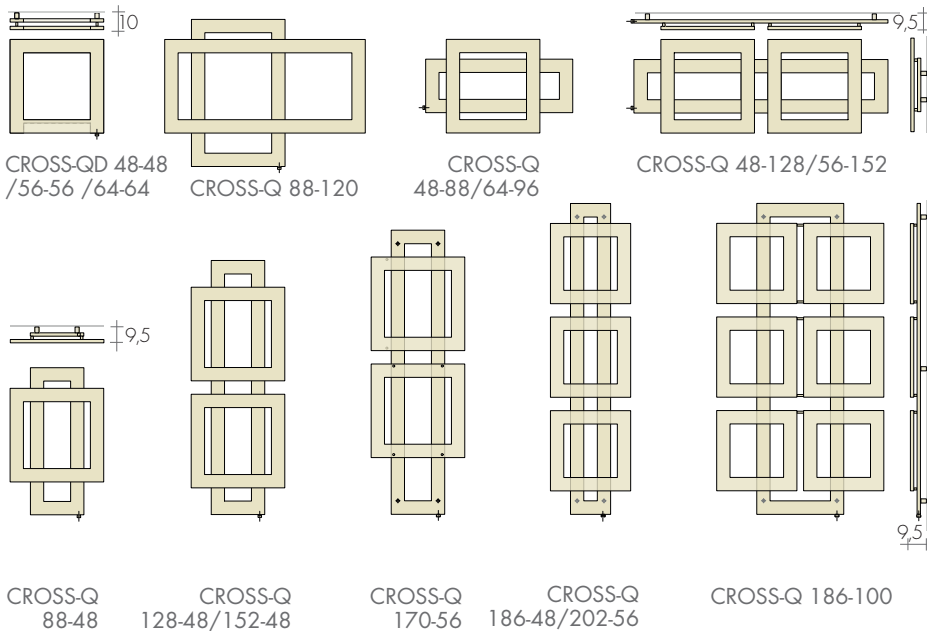

MODEL	H - L cm	Standard white sablé SB 9016 €	BREM Colors		KIT HEATING ELEMENT with:		
			+15% €	+25% €	Cable R...E Art. (W)	Faston R...T Art. (W)	€
CROSS-QD 48-48	48-48	465,40	535,20	581,80	R250IIE	R250IIT	191,90
CROSS-QD 56-56	56-56	506,70	582,70	633,40	R300IIE	R300IIT	193,80
CROSS-QD 64-64	64-64	531,80	611,60	664,80	R400IIE	R400IIT	195,70
CROSS-Q 48-88	48-88	731,70	841,50	914,60	R400IIE	R400IIT	195,70
CROSS-Q 48-128	48-128	1015,70	1168,10	1269,60	R650IIE	R650IIT	222,90
CROSS-Q 56-152	56-152	1101,00	1266,20	1376,30	R800IIE	R800IIT	240,50
CROSS-Q 64-96	64-96	826,10	950,00	1032,60	R500IIE	R500IIT	208,50
CROSS-Q 88-48	88-48	718,10	825,80	897,60	R400IIE	R400IIT	195,70
CROSS-Q 88-120	88-120	894,50	1028,70	1118,10	R650IIE	R650IIT	206,40
CROSS-Q 128-48	128-48	1008,00	1159,20	1260,00	R650IIE	R650IIT	222,90
CROSS-Q 152-48	152-48	1059,70	1218,70	1324,60	R650IIE	R650IIT	222,90
CROSS-Q 170-56	170-56	1290,40	1484,00	1613,00	R800IIE	R800IIT	240,50
CROSS-Q 186-48	186-48	1310,20	1506,70	1637,80	R900IIE	R900IIT	255,30
CROSS-Q 186-100	186-100	2132,50	2452,40	2665,60	R1500IIE	R1500IIT	298,00
CROSS-Q 202-56	202-56	1374,60	1580,80	1718,30	R1200IIE	R1200IIT	276,30

HEATING EL. POSITION
 ☉ Horizontal Heating El.
 ☉ Vertical Heating El.

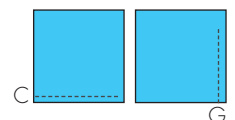

ELECTRIC VERSIONS

THERMOSTATS IN THE RADIATOR FOR KIT RT P. 209

THERMOSTAT mod. DYP



White with
white cable cover
Art. DYPB 89,60€

∅ 7 x 9 x 5 cm



Black with
black cable cover
Art. DYPN 103,40€

REMOTE CONTROL for thermostats DYP

10,8 x 5,3 x 2,3 cm



Art. TIR 41,00€

THERMOSTAT CIRCLE Wi-Fi
up to 800 W
heating elements



∅ 6 x 8 h x 5 cm



Chrome/Black finish
Art. CIR-wifi 198,50€



e.CROSS-R

design Luigi Brembilla

TECHNICAL DATA and other dimensions p. 66
ELECTRIC KIT DATA p. 208-209

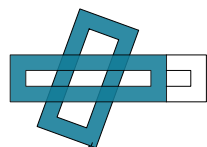

CROSS-R 70-104/124
R-CROM 70-124

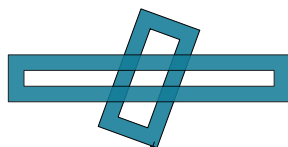

CROSS-R 70-144

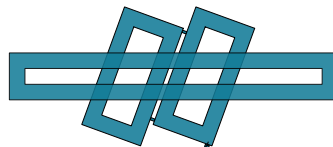

CROSS-R2 70-144/164

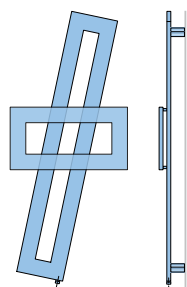
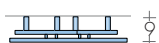

CROSS-R 137-56
R-CROM 137-64

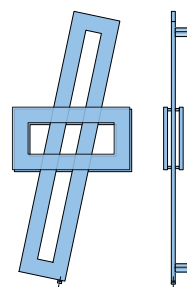
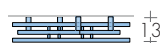

CROSS-RD 137-56

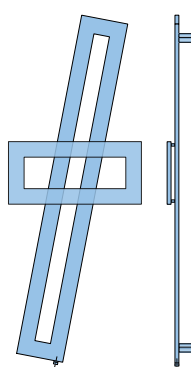

R-CROM 177-64

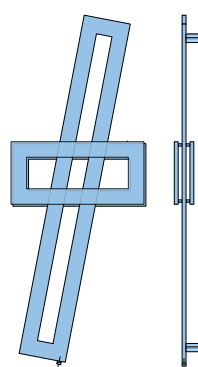

CROSS-RD 177-64

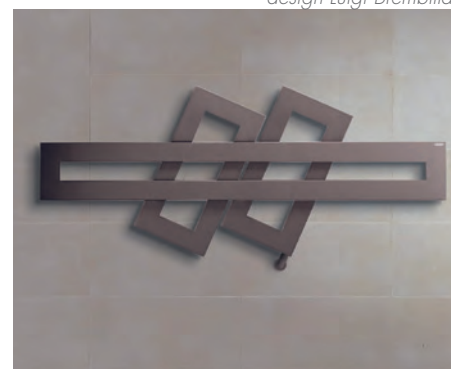

MODELE	H - L cm	Standard white	BREM Colors	BREM Colors	KIT HEATING ELEMENT with:		
		sablé SB 9016 €	+15% €	+25% €	Cable R..E Art. (W)	Faston R..T Art. (W)	€
CROSS-R	70-104	829,80	954,30	1037,30	R400IIE	R400IIT	195,70
CROSS-R	70-124	908,10	1044,30	1135,10	R500IIE	R500IIT	208,50
CROSS-R	70-144	986,40	1134,40	1233,00	R500IIE	R500IIT	208,50
CROSS-R2	70-144	1259,80	1448,80	1574,80	R650IIE	R650IIT	222,90
CROSS-R2	70-164	1443,70	1660,30	1804,60	R800IIE	R800IIT	240,50
CROSS-R	137-56	919,30	1057,20	1149,10	R500IIE	R500IIT	208,50
CROSS-RD	137-56	1244,00	1430,60	1555,00	R650IIE	R650IIT	222,90
CROSS-RD	177-64	1382,00	1589,30	1727,50	R800IIE	R800IIT	240,50
CHROME FINISH							
R-CROM	70-124	2152,30	-	-	R400IIE	R400IIT	195,70
R-CROM	137-56	2262,00	-	-	R500IIE	R500IIT	208,50
R-CROM	177-64	2730,10	-	-	R500IIE	R500IIT	208,50

HEATING ELEMENT POSITION
© Vertical Heating Element



G

THERMOSTATS Wi-Fi FOR KIT RE P. 208

ACCESSORIES FOR

E.H.E. white cable cover
or radiator color (together)
Art.CCRE38 ø3/8" 73,40€
Art.CCRE12 ø1/2" 73,40€



The KIT RT Wi-Fi includes:
- Thermostat RT (battery)
- Gateway
- Built-in receiver

Art. KITRT-wifi 199,80€

Additional receiver
(up to 6) radiators)



Art. SA868 64,20€

KIT ELY Wi-Fi TOP DESIGN includes:
- Thermostat with magnetic charging base
and magnetic plate for wall mounting
- Gateway a 230V
- Built-in Receiver

Art. KITELY-wifi 396,10€

Additional receiver: 1 for each electrical radiators
or split AC (up to 16) Art. SA600 99,10€



e.CUBICO

design Luigi Brembilla

TECHNICAL DATA p. 124
ELECTRIC KIT DATA p. 208-209

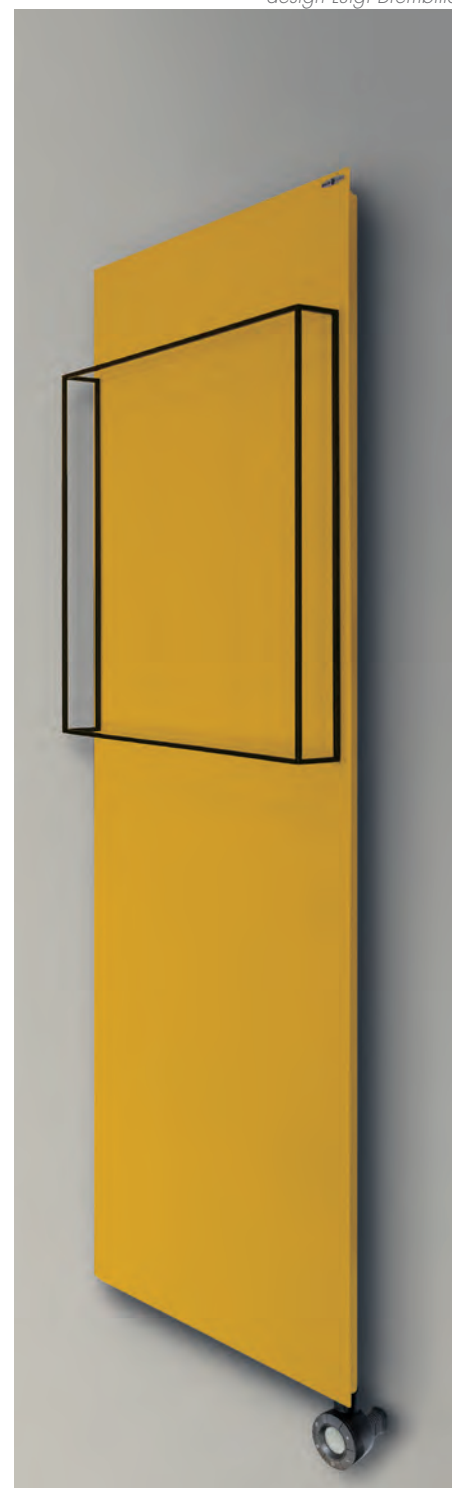
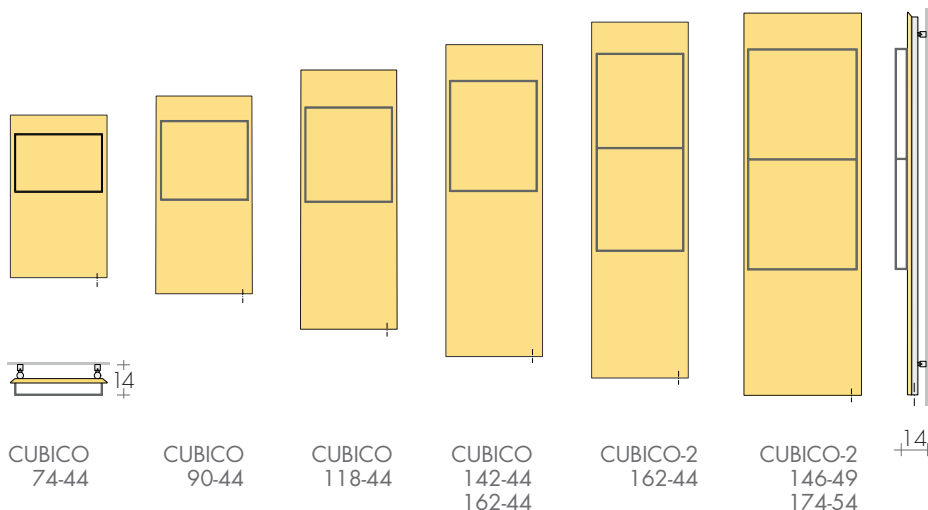

HEATING ELEMENT POSITION
© Vertical Heating Element

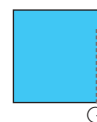

MODELE'25	H - L cm	Standard white sablé SB 9016 €	BREM Colors		KIT HEATING ELEMENT with:		
			+15% €	+25% €	Cable R..E Art. (W)	Faston R..T Art. (W)	€
CUBICO	74-44	708,70	815,00	885,90	R400IIE	R400IIT	195,70
CUBICO	90-44	785,10	902,90	981,40	R500IIE	R500IIT	208,50
CUBICO	118-44	870,10	1000,60	1087,60	R650IIE	R650IIT	222,90
CUBICO	142-44	944,30	1085,90	1180,40	R800IIE	R800IIT	240,50
CUBICO	162-44	1006,40	1157,40	1258,00	R900IIE	R900IIT	255,30
CUBICO-2	162-44	1040,00	1196,00	1300,00	R900IIE	R900IIT	255,30
CUBICO-2	146-49	1026,30	1180,20	1282,90	R900IIE	R900IIT	255,30
CUBICO-2	174-54	1111,90	1278,70	1389,90	R1200IIE	R1200IIT	276,30

TOWEL BAR CUBICO: STANDARD COLORS
 - white sablé SB 9016 - quartz grey SB 7039
 - black sablé SB 9005 - same color as the radiator
 In one paintwork to Brem color list different from the radiator
 Extra Art.CM 52,90€

ELECTRIC VERSIONS

THERMOSTATS IN THE RADIATOR FOR KIT RT P. 209

THERMOSTAT mod. DYP



White with
white cable cover
Art. DYPB 89,60€

ø 7 x 9 x 5 cm



Black with
black cable cover
Art. DYPN 103,40€

REMOTE CONTROL for thermostats DYP

10,8 x 5,3 x 2,3 cm



Art. TIR 41,00€

THERMOSTAT CIRCLE Wi-Fi
up to 800 W
heating elements



ø 6 x 8 h x 5 cm



Chrome/Black finish
Art. CIR-wifi 198,50€



ELECTRIC



TECHNICAL DATA p. 126
ELECTRIC KIT DATA p. 208-209

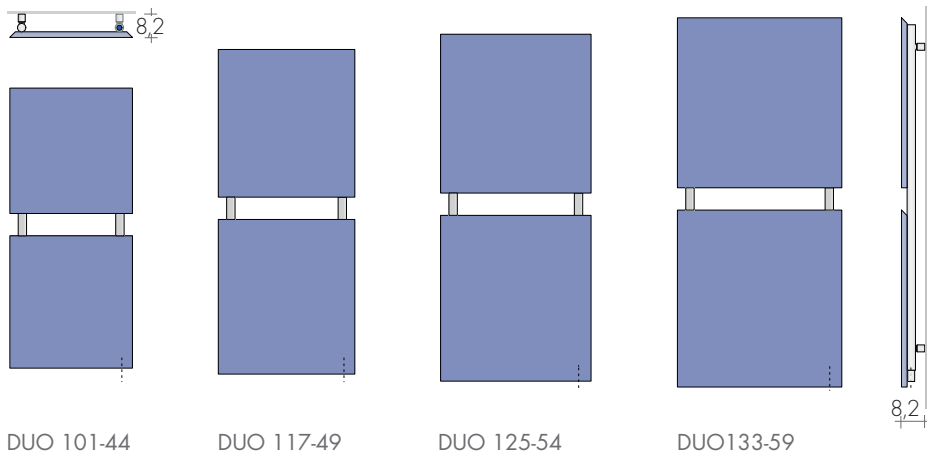

DUO 101-44

DUO 117-49

DUO 125-54

DUO 133-59

MODEL	H - L cm	Standard white	BREM Colors	BREM Colors	KIT HEATING ELEMENT with		
		sablé SB 9016 €	+15% €	+25% €	Cable R..E Art. (W)	Faston R..T Art. (W)	€
DUO	101-44	525,30	604,10	656,60	R500IIE	R500IIT	208,50
DUO	117-49	597,00	686,60	746,30	R650IIE	R650IIT	222,90
DUO	125-54	668,80	769,10	836,00	R800IIE	R800IIT	240,50
DUO	133-59	727,00	836,10	908,80	R900IIE	R900IIT	255,30

BICOLOR SOLUTION:

- BIC10 Cover in a Brem color and back radiator white sablé SB9016 +10%
Cover in standard white and back in Ral color +10%
- BIC20 Cover in a Brem color and back radiator black sablé SB9005 or grey sablé SB7039 +20%
- BIC35 N° 2 Brem colors of your choice +35%



HEATING ELEMENT POSITION
© Vertical Heating Element

THERMOSTATS Wi-Fi FOR KIT RE P. 208

ACCESSORIES FOR

E.H.E. white cable cover
or radiator color (together)
Art.CCRE38 ø3/8" 73,40€
Art.CCRE12 ø1/2" 73,40€



The KIT RT Wi-Fi includes:
- Thermostat RT (battery)
- Gateway
- Built-in receiver

Art. KITRT-wifi 199,80€

Additional receiver
(up to 6) radiators)



Art. SA868 64,20€

KIT ELY Wi-Fi TOP DESIGN includes:
- Thermostat with magnetic charging base
and magnetic plate for wall mounting
- Gateway a 230V
- Built-in Receiver

Art. KITELY-wifi 396,10€

Additional receiver: 1 for each electrical radiators
or split AC (up to 16)



Art. SA600 99,10€

e.ESSEN

design Luigi Brembilla

TECHNICAL DATA and other dimensions p. 70
ELECTRIC KIT DATA p. 208-209

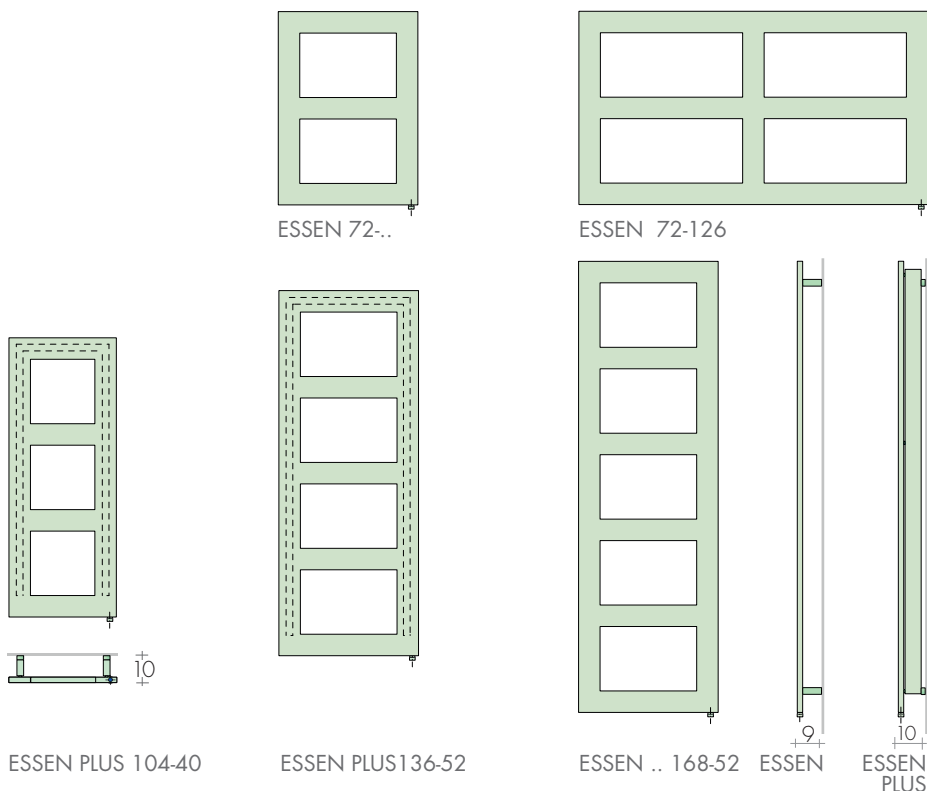

HEATING ELEMENT POSITION
© Vertical Heating Element



MODEL	H - L cm	Standard white	BREM Colors		KIT HEATING ELEMENT with		
		sablé SB 9016 €	+15% €	+25% €	Cable R...E Art. (W)	Faston R...T Art. (W)	€
ESSEN	72-40	632,10	726,90	790,10	R250IIE	R250IIT	191,90
ESSEN PLUS	72-52	657,70	756,40	822,10	R400IIE	R400IIT	195,70
ESSEN	72-126	943,30	1084,80	1179,10	R650IIE	R650IIT	222,90
ESSEN PLUS	104-40	828,00	952,20	1035,00	R500IIE	R500IIT	208,50
ESSEN	136-52	822,50	945,90	1028,10	R500IIE	R500IIT	208,50
ESSEN PLUS	136-52	1183,50	1361,00	1479,40	R800IIE	R800IIT	240,50
ESSEN	168-52	972,40	1118,30	1215,50	R650IIE	R650IIT	222,90
ESSEN PLUS	168-52	1082,50	1244,90	1353,10	R900IIE	R900IIT	255,30
CHROME FINISH							
Essen CROM	136-52	1928,80	-	-	R400IIE	R400IIT	195,70
Essen CROM	168-52	2138,60	-	-	R500IIE	R500IIT	208,50

ELECTRIC VERSIONS

THERMOSTATS IN THE RADIATOR FOR KIT RT P. 209

THERMOSTAT mod. DYP



White with white cable cover
Art. DYPB 89,60€

ø 7 x 9 x 5 cm



Black with black cable cover
Art. DYPN 103,40€

REMOTE CONTROL for thermostats DYP

10,8 x 5,3 x 2,3 cm



Art. TIR 41,00€

THERMOSTAT CIRCLE Wi-Fi
up to 800 W
heating elements



ø 6 x 8 h x 5 cm



Chrome/Black finish
Art. CIR-wifi 198,50€



ELECTRIC



TECHNICAL DATA p. 72
ELECTRIC KIT DATA p. 208-209

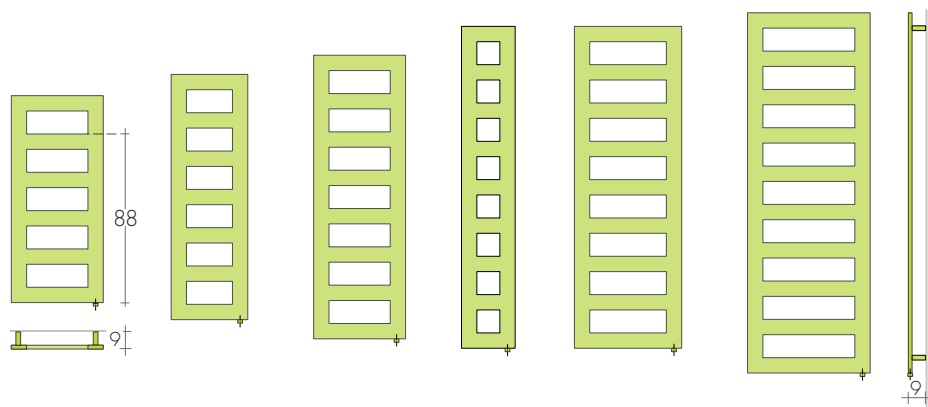

FIT 88-48
FIT 108-48
FIT 128-40
FIT 128-56
FIT 148-48
FIT 168-28
FIT 168-40
FIT 168-56
FIT 168-64
FIT 188-56



HEATING ELEMENT POSITION
© Vertical Heating Element

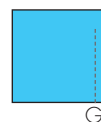

MODEL	H - L cm	Standard white	BREM Colors	BREM Colors	KIT HEATING ELEMENT with:		
		sablé SB 9016 €	+15% €	+25% €	Cable R..E Art. (W)	Faston R..T Art. (W)	€
FIT 88-48	88	704,30	809,90	880,40	R400IIE	R400IIT	195,70
FIT 108-48	108	747,90	860,10	934,90	R500IIE	R500IIT	208,50
FIT 128-40	128	777,70	894,40	972,10	R500IIE	R500IIT	208,50
FIT 128-56	128	877,90	1009,60	1097,40	R650IIE	R650IIT	222,90
FIT 148-48	148	904,40	1040,10	1130,50	R650IIE	R650IIT	222,90
FIT 168-28	168	909,40	1045,80	1136,80	R500IIE	R500IIT	208,50
FIT 168-40	168	940,60	1081,70	1175,80	R650IIE	R650IIT	222,90
FIT 168-56	168	1002,80	1153,20	1253,50	R800IIE	R800IIT	240,50
FIT 168-64	168	1017,00	1169,60	1271,30	R900IIE	R900IIT	255,30
FIT 188-56	188	1067,80	1228,00	1334,80	R900IIE	R900IIT	255,30

THERMOSTATS Wi-Fi FOR KIT RE P. 208

ACCESSORIES FOR

E.H.E. white cable cover
or radiator color (together)
Art.CCRE38 ø3/8" 73,40€
Art.CCRE12 ø1/2" 73,40€



The KIT RT Wi-Fi includes:
- Thermostat RT (battery)
- Gateway
- Built-in receiver

Art. KITRT-wifi 199,80€

Additional receiver
(up to 6) radiators)



Art. SA868 64,20€

KIT ELY Wi-Fi TOP DESIGN includes:
- Thermostat with magnetic charging base
and magnetic plate for wall mounting
- Gateway a 230V
- Built-in Receiver

Art. KITELY-wifi 396,10€

Additional receiver: 1 for each electrical radiators
or split AC (up to 16)



Art. SA600 99,10€



TECHNICAL DATA p. 128
ELECTRIC KIT DATA p. 208-209

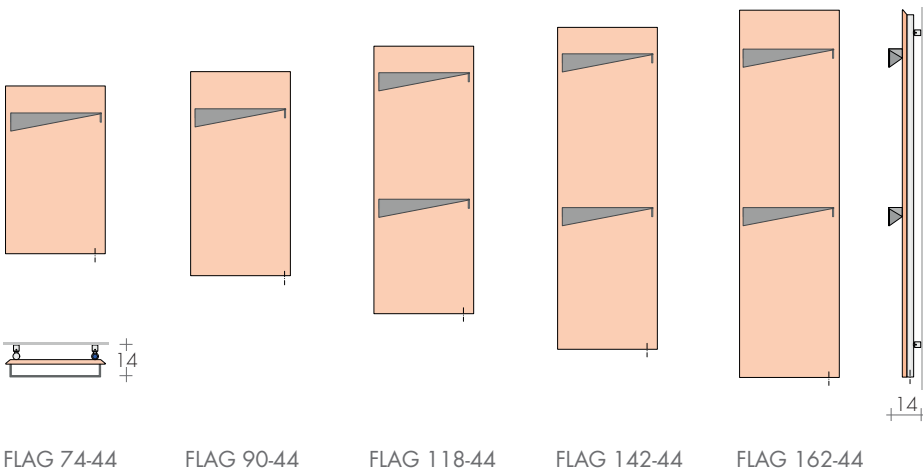

HEATING ELEMENT POSITION
© Vertical Heating Element

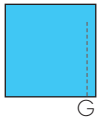

MODEL	H - L cm	Standard white	BREM Colors	BREM Colors	KIT HEATING ELEMENT with:		
		sablé SB 9016 €	+15% €	+25% €	Cable R..E Art. (W)	Faston R..T Art. (W)	€
FLAG	74-44	668,40	768,70	835,50	R400IIE	R400IIT	195,70
FLAG	90-44	744,80	856,50	931,00	R500IIE	R500IIT	208,50
FLAG	118-44	890,30	1023,80	1112,90	R650IIE	R650IIT	222,90
FLAG	142-44	964,40	1109,10	1205,50	R800IIE	R800IIT	240,50
FLAG	162-44	1026,60	1180,60	1283,30	R900IIE	R900IIT	255,30

TOWEL BAR FLAG: STANDARD COLORS
 - white sablé SB 9016 - quartz grey SB 7039
 - black sablé SB 9005 - same color as the radiator
 In one paintwork to Brem color list different from the radiator
 Extra Art.CM 52,90€

ELECTRIC VERSIONS

THERMOSTATS IN THE RADIATOR FOR KIT RT P. 209

THERMOSTAT mod. DYP



White with white cable cover
Art. DYPB 89,60€

ø 7 x 9 x 5 cm



Black with black cable cover
Art. DYPN 103,40€

REMOTE CONTROL for thermostats DYP

10,8 x 5,3 x 2,3 cm



Art. TIR 41,00€

THERMOSTAT CIRCLE Wi-Fi
up to 800 W
heating elements



ø 6 x 8 h x 5 cm



Chrome/Black finish
Art. CIR-wifi 198,50€



TECHNICAL DATA and other dimensions page 174
ELECTRIC KIT DATA page 208-209

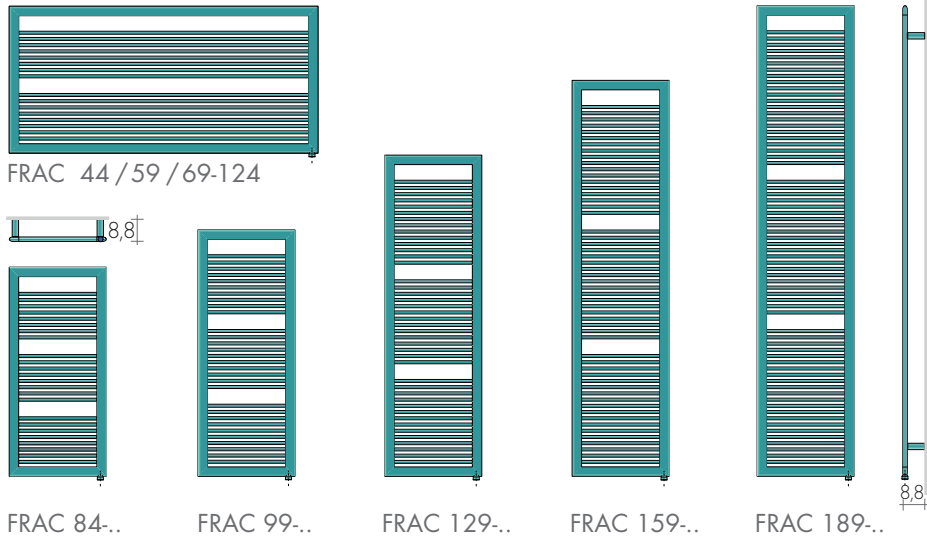

MODELE	H - L cm	Standard white	BREM Colors	BREM Colors	KIT HEATING ELEMENT with:		
		sablé SB 9016 €	+15% €	+25% €	Cable R.E Art. (W)	Faston R.T Art. (W)	€
FRAC 44-124	44-124	593,30	682,30	741,60	R500IIE	R500IIT	208,50
FRAC 59-124	59-124	709,50	815,90	886,90	R650IIE	R650IIT	222,90
FRAC 69-124	69-124	817,60	940,20	1022,00	R800IIE	R800IIT	240,50
FRAC 84-39	49-49	499,40	574,30	624,30	R300IIE	R300IIT	193,80
FRAC 84-49	518,20	518,20	595,90	647,80	R400IIE	R400IIT	195,70
FRAC 99-39	588,20	588,20	676,40	735,30	R400IIE	R400IIT	195,70
FRAC 99-49	608,90	608,90	700,20	761,10	R500IIE	R500IIT	208,50
FRAC 129-39	683,60	683,60	786,10	854,50	R500IIE	R500IIT	193,10
FRAC 129-49	704,60	704,60	810,30	880,80	R650IIE	R650IIT	206,40
FRAC 159-39	808,20	808,20	929,40	1010,30	R650IIE	R650IIT	222,90
FRAC 159-49	828,80	828,80	953,10	1036,00	R800IIE	R800IIT	240,50
FRAC 159-54	902,90	902,90	1038,30	1128,60	R900IIE	R900IIT	255,30
FRAC 189-39	937,00	937,00	1077,60	1171,30	R800IIE	R800IIT	240,50
FRAC 189-59	944,20	944,20	1085,80	1180,30	R1200IIE	R1200IIT	276,30

CHROME HOOK
(ø 3 x 3,5 cm) p.277 Art. AC n°2 90,90€



HEATING ELEMENT POSITION
© Vertical Heating Element

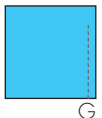

THERMOSTATS Wi-Fi FOR KIT RE P. 208

ACCESSORIES FOR

E.H.E. white cable cover
or radiator color (together)
Art.CCRE38 ø3/8" 73,40€
Art.CCRE12 ø1/2" 73,40€



The KIT RT Wi-Fi includes:
- Thermostat RT (battery)
- Gateway
- Built-in receiver

Art. KITRT-wifi 199,80€

Additional receiver
(up to 6) radiators)



Art. SA868 64,20€

KIT ELY Wi-Fi TOP DESIGN includes:
- Thermostat with magnetic charging base
and magnetic plate for wall mounting
- Gateway a 230V
- Built-in Receiver

Art. KITELY-wifi 396,10€

Additional receiver: 1 for each electrical radiators
or split AC (up to 16) Art. SA600 99,10€



TECHNICAL DATA
and other dimensions page 74
ELECTRIC KIT DATA page 208-209

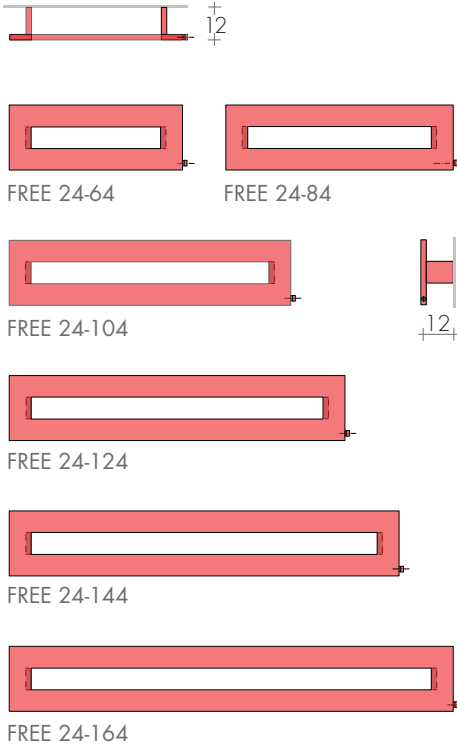

CABLE COVER FREE
E.H.E. L = 12 cm
Art. CCREF 89,60€

MODEL'25	H - L cm	Standard white	BREM Colors		KIT HEATING ELEMENT with		
		sablé SB 9016 €	+15% €	+25% €	Cable R.E Art. (W)	Faston R.T Art. (W)	€
FREE	24-64	351,70	404,50	439,60	R250IIE	R250IIT	191,90
FREE	24-84	392,20	451,00	490,30	R250IIE	R250IIT	191,90
FREE	24-104	432,80	497,70	541,00	R300IIE	R300IIT	193,80
FREE	24-124	473,30	544,30	591,60	R300IIE	R300IIT	193,80
FREE	24-144	514,00	591,10	642,50	R400IIE	R400IIT	195,70
FREE	24-164	554,70	637,90	693,40	R500IIE	R500IIT	193,10



HEATING ELEMENT POSITION
ⓐ Horizontal Heating Element
On request, Element in ⓐ



ELECTRIC VERSIONS

THERMOSTATS IN THE RADIATOR FOR KIT RT P. 209

THERMOSTAT mod. DYP



White with
white cable cover
Art. DYPB 89,60€

ø 7 x 9 x 5 cm



Black with
black cable cover
Art. DYPN 103,40€

REMOTE CONTROL for thermostats DYP

10,8 x 5,3 x 2,3 cm



Art. TIR 41,00€

THERMOSTAT CIRCLE Wi-Fi
up to 800 W
heating elements



ø 6 x 8 h x 5 cm



Chrome/Black finish
Art. CIR-wifi 198,50€



TECHNICAL DATA and other dimensions page 130
ELECTRIC KIT DATA page 208-209

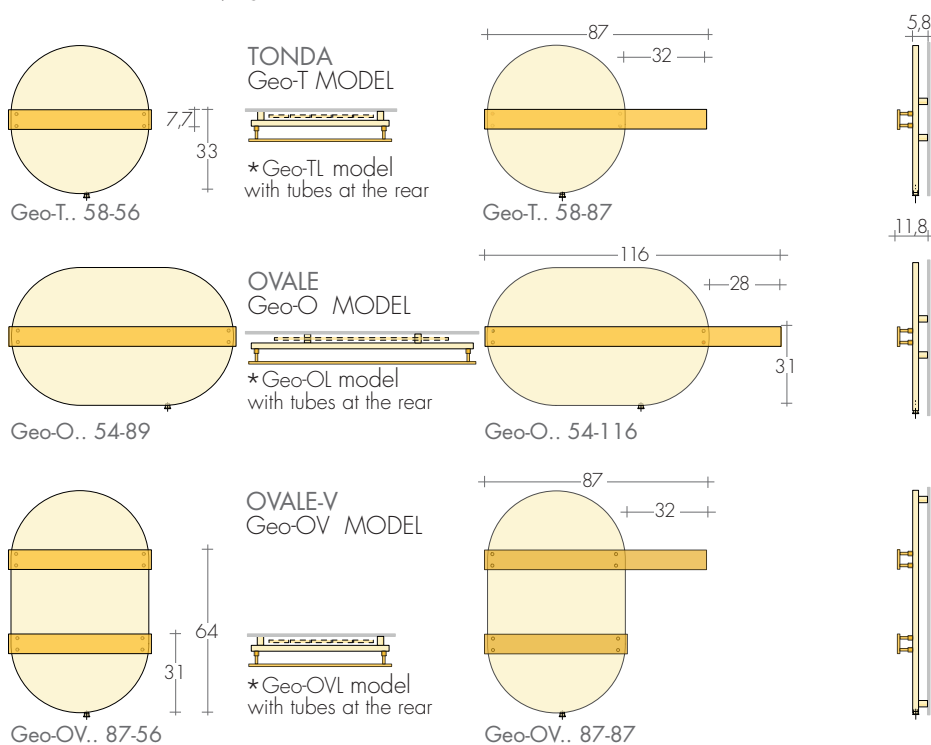

ON REQUEST, FREE OF CHARGE, TOWEL BAR WITH THE LEFT EXTENSION

MODEL	H - L cm	Standard white	BREM Colors		KIT HEATING ELEMENT with:		
		sablé SB 9016 €	+15% €	+25% €	Cable R..E Art. (W)	Faston R..T Art. (W)	€
Geo-T	58-56	893,80	1027,90	1117,30	R300IIE	R300IIT	193,80
Geo-TL	58-56	1093,70	1257,80	1367,10	R500IIE	R500IIT	208,50
Geo-T	58-87	923,20	1061,70	1154,00	R400IIE	R400IIT	195,70
Geo-TL	58-87	1123,10	1291,60	1403,90	R500IIE	R500IIT	208,50
Geo-O	54-89	952,60	1095,50	1190,80	R500IIE	R500IIT	208,50
Geo-OL	54-89	1152,50	1325,40	1440,60	R800IIE	R800IIT	240,50
Geo-O	54-116	993,80	1142,90	1242,30	R500IIE	R500IIT	208,50
Geo-OL	54-116	1193,70	1372,80	1492,10	R800IIE	R800IIT	240,50
Geo-OV	87-56	1070,20	1230,70	1337,80	R500IIE	R500IIT	208,50
Geo-OVL	87-56	1270,10	1460,60	1587,60	R800IIE	R800IIT	240,50
Geo-OV	87-87	1099,60	1264,50	1374,50	R650IIE	R650IIT	222,90
Geo-OVL	87-87	1299,50	1494,40	1624,40	R800IIE	R800IIT	240,50

TOWEL BAR GEO: STANDARD COLORS

- white sablé SB 9016 - quartz grey SB 7039
- black sablé SB 9005 - same color as the radiator

In one paintwork to Brem color list different from the radiator
Extra Art.CM 52,90€

HEATING ELEMENT POSITION
© Vertical Heating Element



THERMOSTATS Wi-Fi FOR KIT RE P. 208

ACCESSORIES FOR

E.H.E. white cable cover
or radiator color (together)
Art.CCRE38 ø3/8" 73,40€
Art.CCRE12 ø1/2" 73,40€



The KIT RT Wi-Fi includes:
- Thermostat RT (battery)
- Gateway
- Built-in receiver

Art. KITRT-wifi 199,80€

Additional receiver
(up to 6) radiators)

Art. SA868

64,20€



KIT ELY Wi-Fi TOP DESIGN includes:
- Thermostat with magnetic charging base
and magnetic plate for wall mounting
- Gateway a 230V
- Built-in Receiver

Art. KITELY-wifi 396,10€

Additional receiver: 1 for each electrical radiators
or split AC (up to 16) Art. SA600 99,10€



e.GEOMETRICA

e.GEO-QUADRA e.GEO-RETTANGOLARE

TECHNICAL DATA and other dimensions page 132
ELECTRIC KIT DATA page 208-209

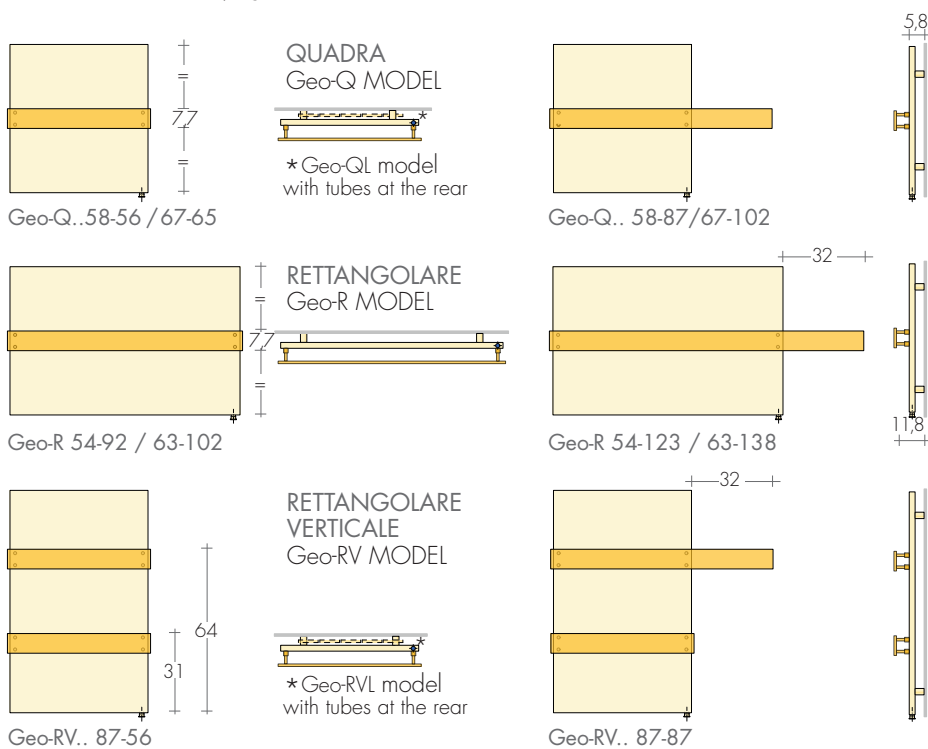

MODEL	H - L cm	Standard white	BREM Colors	BREM Colors	KIT HEATING ELEMENT with:		
		sablé SB 9016 €	+15% €	+25% €	Cable R.E Art. (VV)	Faston R.T Art. (VV)	€
Geo-Q 58-56	58-56	946,70	1088,70	1183,40	R400IIE	R400IIT	195,70
Geo-QL 58-56	58-56	1146,70	1318,70	1433,40	R500IIE	R500IIT	208,50
Geo-Q 58-87	58-87	976,10	1122,50	1220,10	R400IIE	R400IIT	195,70
Geo-QL 58-87	58-87	1164,20	1338,80	1455,30	R500IIE	R500IIT	208,50
Geo-Q 67-65	67-65	1009,00	1160,40	1261,30	R500IIE	R500IIT	208,50
Geo-QL 67-65	67-65	1244,20	1430,80	1555,30	R650IIE	R650IIT	222,90
Geo-Q 67-102	67-102	1044,30	1200,90	1305,40	R650IIE	R650IIT	222,90
Geo-QL 67-102	67-102	1273,70	1464,80	1592,10	R800IIE	R800IIT	240,50
Geo-R 54-92	54-92	1039,60	1195,50	1299,50	R650IIE	R650IIT	222,90
Geo-R 54-123	54-123	1080,80	1242,90	1351,00	R650IIE	R650IIT	222,90
Geo-R 63-102	63-102	1186,00	1363,90	1482,50	R800IIE	R800IIT	240,50
Geo-R 63-138	63-138	1227,20	1411,30	1534,00	R900IIE	R900IIT	255,30
Geo-RV 87-56	87-56	1064,30	1223,90	1330,40	R650IIE	R650IIT	222,90
Geo-RVL 87-56	87-56	1264,30	1453,90	1580,40	R800IIE	R800IIT	240,50
Geo-RV 87-87	87-87	1093,70	1257,80	1367,10	R650IIE	R650IIT	222,90

TOWEL BAR GEO: STANDARD COLORS
- white sablé SB 9016 - quartz grey SB 7039
- black sablé SB 9005 - same color as the radiator
In one paintwork to Brem color list different from the radiator
Extra Art.CM 52,90€

ON REQUEST, BAR with DOUBLE PROJECTION

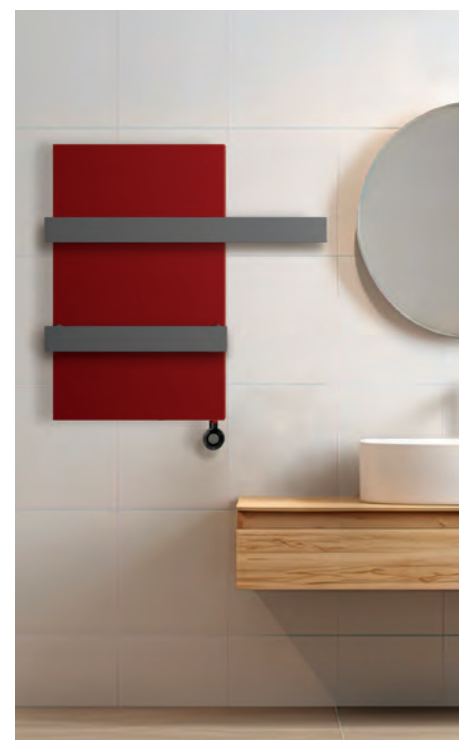
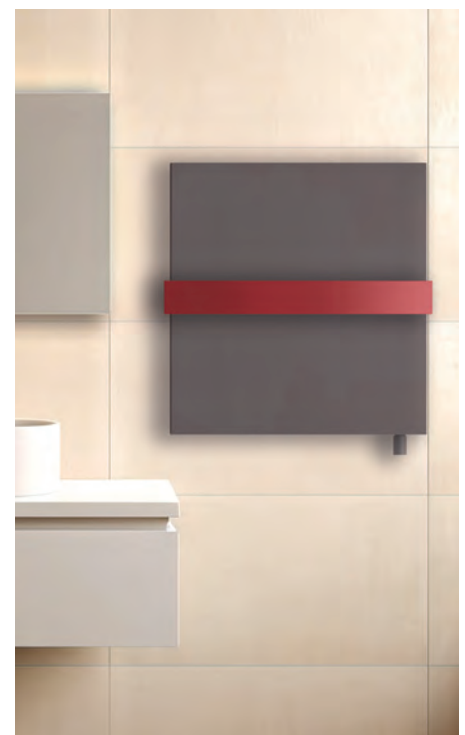
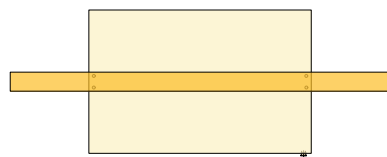

HEATING ELEMENT POSITION
© Vertical Heating Element

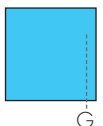

ELECTRIC VERSIONS

THERMOSTATS IN THE RADIATOR FOR KIT RT P. 209

THERMOSTAT mod. DYP



White with white cable cover
Art. DYPB 89,60€

ø 7 x 9 x 5 cm



Black with black cable cover
Art. DYPN 103,40€

REMOTE CONTROL for thermostats DYP

10,8 x 5,3 x 2,3 cm



Art. TIR 41,00€

THERMOSTAT CIRCLE Wi-Fi
up to 800 W
heating elements



ø 6 x 8 h x 5 cm



Chrome/Black finish
Art. CIR-wifi 198,50€



e.GUEST

design Davide Diliberto

TECHNICAL DATA page 28
ELECTRIC KIT DATA page 208

FREESTANDING MODELS

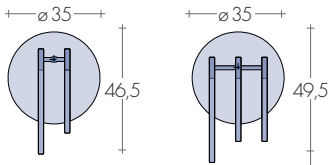

GUEST-A
104-12

GUEST-A
104-22



GUEST-A
104-12

GUEST-A
104-22

SUSPENDED MODELS and MODELS WITH FEET

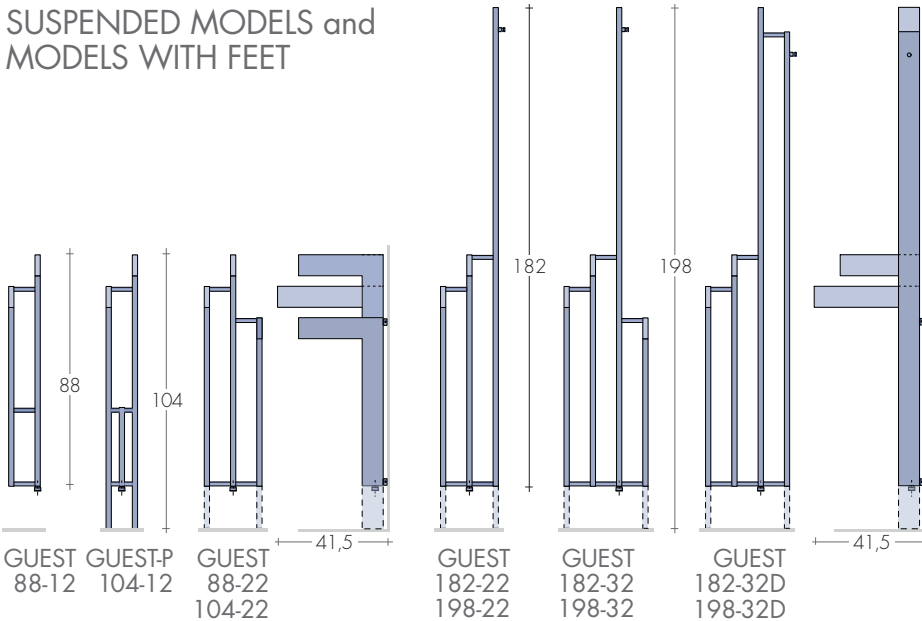

GUEST
88-12

GUEST-P
104-12

GUEST
88-22
104-22

GUEST
182-22
198-22

GUEST
182-32
198-32

GUEST
182-32D
198-32D

MODEL	H - L cm	Standard white	BREM Colors	BREM Colors	KIT HEATING ELEMENT with:		
		sablé SB 9016 €	+15% €	+25% €	Cable R.E Art. (W)	Faston R.T Art. (W)	€
GUEST	88-12	391,70	450,50	489,60	R250IIE	R250IIF	191,90
GUEST	88-22	526,40	605,40	658,00	R400IIE	R400IIF	195,70
GUEST	182-22	613,50	705,50	766,90	R500IIE	R500IIF	208,50
GUEST	182-32	695,00	799,30	868,80	R650IIE	R650IIF	222,90
GUEST	182-32D	753,40	866,40	941,80	R650IIE	R650IIF	222,90
MODELS WITH FEET							
GUEST	104-12	428,00	492,20	535,00	R300IIE	R300IIT	193,80
GUEST	104-22	562,70	647,10	703,40	R400IIE	R400IIT	195,70
GUEST	198-22	649,80	747,30	812,30	R500IIE	R500IIT	208,50
GUEST	198-32	731,20	840,90	914,00	R650IIE	R650IIT	222,90
GUEST	198-32D	789,70	908,20	987,10	R800IIE	R800IIT	240,50
FREESTANDING MODELS							
GUEST	104-12	498,50	573,30	623,10	R300IIE	R300IIT	193,80
GUEST	104-22	633,20	728,20	791,50	R400IIE	R400IIT	195,70



HEATING ELEMENT POSITION
© Vertical Heating Element

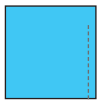

G

THERMOSTATS Wi-Fi FOR KIT RE P. 208

ACCESSORIES FOR

White cable cover or radiator color (Painted together) for E.H.E.)

Art.CCRE38 \varnothing 3/8" 73,40€
Art.CCRE12 \varnothing 1/2" 73,40€



The KIT RT Wi-Fi includes:

- Thermostat RT (battery)
- Gateway
- Built-in receiver

Art. KITRT-wifi 199,80€

Additional receiver
(up to 6) radiators)

Art. SA868 64,20€



KIT ELY Wi-Fi TOP DESIGN includes:

- Thermostat with magnetic charging base and magnetic plate for wall mounting
- Gateway a 230V
- Built-in Receiver

Art. KITELY-wifi 396,10€

Additional receiver: 1 for each electrical radiators or split AC (up to 16) Art. SA600 99,10€



e.HAND

design Luigi Brembilla

Electric heated towel rail for bathroom towels available in two sizes: 55 and 123 cm; powered by electrical supply 24VDC.

Hand can be installed horizontally or vertically, left or right, high or low connection, to allow free compositions.

DIMENSIONS

Lengths: 7,7 / 55 / 123 cm
 Heights: 7,7 / 55 / 123 cm
 Depth / Depth from wall: 7 cm

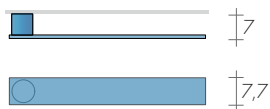

HAND 8-55

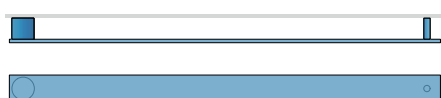

HAND 8-123

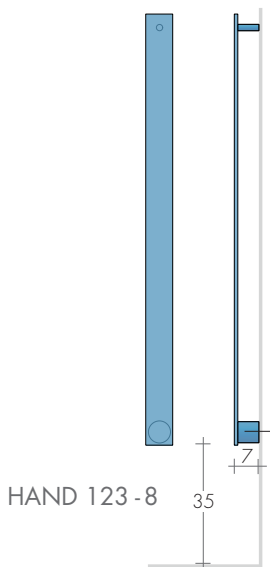

HAND 123-8



SPECIAL GALVANIC FINISHES on request

- GOLD
- BRONZE
- NICKEL BRUSHED
- BLACK NICKEL



MODEL	H-L cm	PRICES INCLUDE THE ELECTRIC ELEMENT, 24VDC			Heating ELEMENT 24VDC - Class III THERMAL OUTPUT /Consumption
		Standard white sablé SB 9016 €	BREM Colors +15% €	BREM Colors +25% €	
HAND 8-55	55	526,40	605,40	658,00	30 W
HAND 8-123	123	694,40	798,60	868,00	75 W
HAND 55-8	55	526,40	605,40	658,00	30 W
HAND 123-8	123	694,40	798,60	868,00	75 W

HAND: suitable for bathrobes
 Art. HB 44,20€

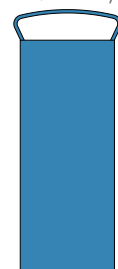

Prepare 24vDC CONTROLLED LIGHT POINT with SELV POWER SUPPLY

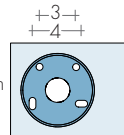
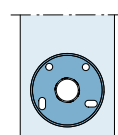

FIXINGS included

CONNECTION E.H.E. 24VDC

ELECTRIC VERSIONS

THERMOSTATS IN THE RADIATOR FOR KIT RT P. 209 DO NOT USE with HAND

THERMOSTAT mod. DYP



White with white cable cover
 Art. DYPB 89,60€

ø 7 x 9 x 5 cm



Black with black cable cover
 Art. DYPN 103,40€

REMOTE CONTROL for thermostats DYP

10,8 x 5,3 x 2,3 cm



Art. TIR 41,00€

THERMOSTAT CIRCLE Wi-Fi
 up to 800 W heating elements



ø 6 x 8 x 5 cm



Chrome/Black finish
 Art. CIR-wifi 198,50€



e.HERG-ÖT

design Luigi Brebbia

TECHNICAL DATA and other dimensions p. 30
ELECTRIC KIT DATA p. 208-209

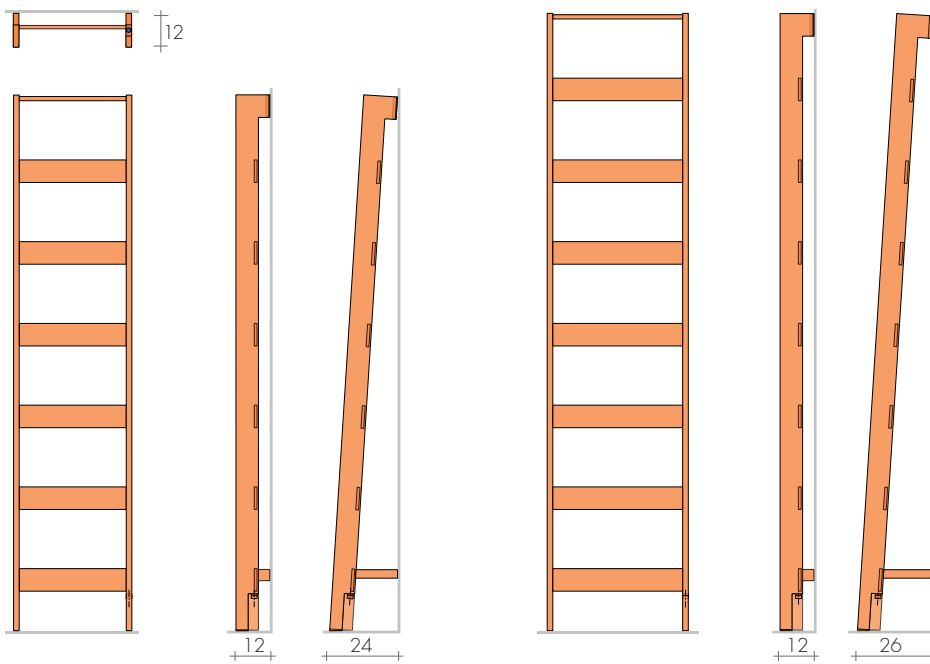

HERG-ÖT 185-42

HERG-ÖT 212-50 ..58



MODEL	H - L cm	Standard white sablé SB 9016 €	BREM Colors +15% €	BREM Colors +25% €	KIT HEATING ELEMENT with:		
					Cable R.E Art. (W)	Faston R.T Art. (W)	€
HERG-ÖT 185-42	185-42	995,20	1144,50	1244,00	R650IIE	-	222,90
HERG-ÖT 185-50	185-50	1163,20	1337,70	1454,00	R800IIE	-	240,50
HERG-ÖT 185-58	185-58	1204,20	1384,80	1505,30	R900IIE	-	255,30
Angled HERG-ÖT, extra Art. HOI			108,80€	ONLY with Wi-Fi THERMOSTATS for KIT RE			

HEATING ELEMENT POSITION
© Vertical Heating Element

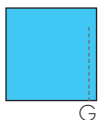

THERMOSTATS Wi-Fi FOR KIT RE P. 208

ACCESSORIES FOR

E.H.E. white cable cover
or radiator color (together)
Art.CCRE38 ø3/8" 73,40€
Art.CCRE12 ø1/2" 73,40€



The KIT RT Wi-Fi includes:
- Thermostat RT (battery)
- Gateway
- Built-in receiver

Art. KITRT-wifi 199,80€

Additional receiver
(up to 6) radiators)

Art. SA868 64,20€



KIT ELY Wi-Fi TOP DESIGN includes:
- Thermostat with magnetic charging base
and magnetic plate for wall mounting
- Gateway a 230V
- Built-in Receiver

Art. KITELY-wifi 396,10€

Additional receiver: 1 for each electrical radiators
or split AC (up to 16) Art. SA600 99,10€



e.HERG'S TOWEL HEATERS

e.HERG RADIATORS

design Luigi Brembilla

TECHNICAL DATA

HERG RADIATORS page 14
 HERG'S TOWEL-HEATERS page 32
 On request other dimensions
 ELECTRIC KIT DATA page 208-209

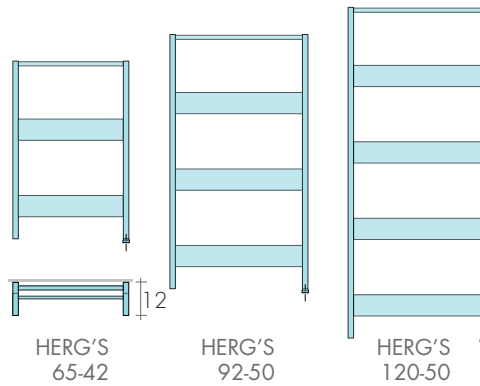

HERG'S 65-42

HERG'S 92-50

HERG'S 120-50

HERG HGS

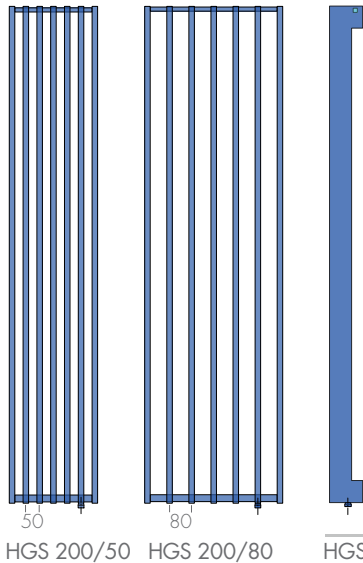

HGS 200/50

HGS 200/80

HGS..

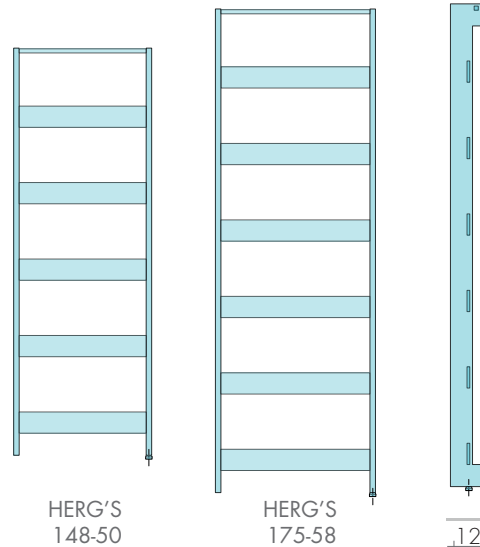

HERG'S 148-50

HERG'S 175-58



HERG'S 92-50



HGS 200/50 - 7el

MODEL	H - L cm	Standard white	BREM Colors	BREM Colors	KIT HEATING ELEMENT with:		
		sablé SB 9016 €	+15% €	+25% €	Cable R..E Art. (W)	Faston R..T Art. (W)	€
Towelheaters							
HERG'S	65-42	533,80	613,90	667,30	R250IIE	R250IIT	191,90
HERG'S	92-50	642,40	738,80	803,00	R400IIE	R400IIT	195,70
HERG'S	120-50	786,40	904,40	983,00	R500IIE	R500IIT	208,50
HERG'S	148-50	895,10	1029,40	1118,90	R650IIE	R650IIT	222,90
HERG'S	175-58	1031,40	1186,10	1289,30	R800IIE	R800IIT	240,50
Radiators							
	Hcm/PE -n°el. L cm						
HGS	180/80-5el 34	976,60	1123,10	1220,80	R900IIE	R900IIT	255,30
HGS	200/50-5el 22	1016,00	1168,40	1270,00	R800IIE	R800IIT	240,50
HGS	200/80-5el 34	1016,00	1168,40	1270,00	R900IIE	R900IIT	255,30
HGS	200/80-6el 42	1145,40	1317,20	1431,80	R1200IIE	R1200IIT	276,30
HGS	200/50-7el 32	1275,10	1466,40	1593,90	R1200IIE	R1200IIT	276,30
HGS	200/80-8el 58	1404,70	1615,40	1755,90	R1500IIE	R1500IIT	298,00
HGS	200/50-9el 42	1534,40	1764,60	1918,00	R1500IIE	R1500IIT	298,00

PE = step (distance between the midpoints of 2 elements)

HEATING ELEMENT POSITION
 © Vertical Heating Element

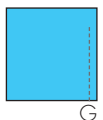

ELECTRIC VERSIONS

THERMOSTATS IN THE RADIATOR FOR KIT RT P. 209

THERMOSTAT mod. DYP



White with white cable cover
 Art. DYPB 89,60€

ø 7 x 9 x 5 cm



Black with black cable cover
 Art. DYPN 103,40€

REMOTE CONTROL for thermostats DYP

10,8 x 5,3 x 2,3 cm



Art. TIR 41,00€

THERMOSTAT CIRCLE Wi-Fi up to 800 W heating elements



ø 6 x 8 x 5 cm



Chrome/Black finish
 Art. CIR-wifi 198,50€



TECHNICAL DATA and other dimensions p.34
ELECTRIC KIT DATA p. 208-209

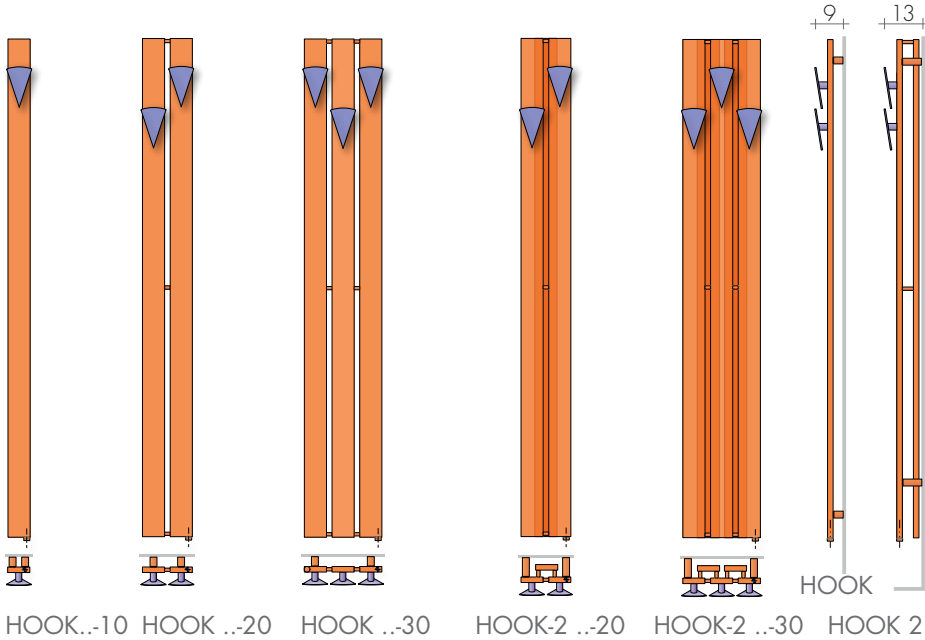

MODEL	H - L cm	Standard white	BREM Colors		KIT HEATING ELEMENT with:		
		sablé SB 9016 €	+15% €	+25% €	Cable R..E Art. (W)	Faston R..T Art. (W)	€
HOOK	180-20	771,80	887,60	964,80	R400IIE	R400IIT	195,70
HOOK	180-30	981,70	1129,00	1227,10	R500IIE	R500IIT	208,50
HOOK	210-10	580,80	667,90	726,00	R250IIE	R250IIT	191,90
HOOK	210-20	790,60	909,20	988,30	R400IIE	R400IIT	195,70
HOOK	210-30	1000,20	1150,20	1250,30	R650IIE	R650IIT	222,90
HOOK-2	180-20	971,80	1117,60	1214,80	R500IIE	R500IIT	208,50
HOOK-2	180-30	996,80	1146,30	1246,00	R650IIE	R650IIT	222,90
HOOK-2	210-20	1156,50	1330,00	1445,60	R650IIE	R650IIT	222,90
HOOK-2	210-30	1181,20	1358,40	1476,50	R900IIE	R900IIT	255,30

KNOB mod. HK: STANDARD COLORS
- white sablé SB 9016 - quartz grey SB 7039
- black sablé SB 9005 - same color as the radiator
In one paintwork to Brem color list different from the radiator
Extra Art. CM 52,90€

KNOB, on demand without extra

Mod. PO



Mod. ARO



HEATING ELEMENT POSITION
© Vertical Heating Element

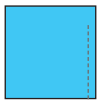

G

THERMOSTATS Wi-Fi FOR KIT RE P. 208

ACCESSORIES FOR

E.H.E. white cable cover
or radiator color (together)
Art.CCRE38 ø3/8" 73,40€
Art.CCRE12 ø1/2" 73,40€



The KIT RT Wi-Fi includes:
- Thermostat RT (battery)
- Gateway
- Built-in receiver

Art. KITRT-wifi 199,80€

Additional receiver
(up to 6) radiators)

Art. SA868 64,20€



KIT ELY Wi-Fi TOP DESIGN includes:
- Thermostat with magnetic charging base
and magnetic plate for wall mounting
- Gateway a 230V
- Built-in Receiver

Art. KITELY-wifi 396,10€

Additional receiver: 1 for each electrical radiators
or split AC (up to 16) Art. SA600 99,10€



e.KORE PLUS

design Luigi Brembilla

TECHNICAL DATA and other dimensions p.76
ELECTRIC KIT DATA p. 208-209

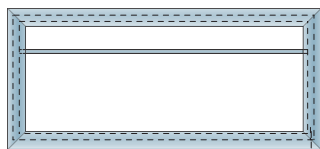

KORE-P 55-124

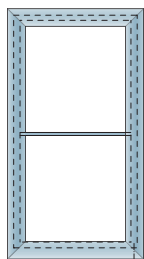

KORE-P 98-54

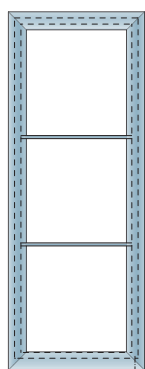

KORE-P 140-54

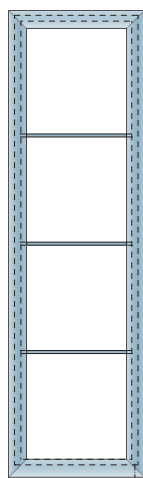

KORE-P 180-54

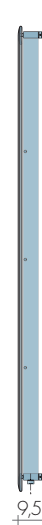

HEATING ELEMENT POSITION
© Vertical Heating Element



MODEL	H - L cm	Standard white sablé SB 9016 €	BREM Colors		KIT HEATING ELEMENT with:		
			+15% €	+25% €	Cable R..E Art. (W)	Faston R..T Art. (W)	€
KORE-P	55-124	658,80	757,60	823,50	R500IIE	R500IIT	208,50
KORE-P	98-54	567,70	652,90	709,60	R400IIE	R400IIT	195,70
KORE-P	140-54	687,10	790,20	858,90	R500IIE	R500IIT	208,50
KORE-P	180-54	738,90	849,70	923,60	R650IIE	R650IIT	222,90

ELECTRIC VERSIONS

THERMOSTATS IN THE RADIATOR FOR KIT RT P. 209

THERMOSTAT mod. DYP



White with
white cable cover
Art. DYPB 89,60€

ø 7 x 9 x 5 cm



Black with
black cable cover
Art. DYPN 103,40€

REMOTE CONTROL for thermostats DYP

10,8 x 5,3 x 2,3 cm



Art. TIR 41,00€

THERMOSTAT CIRCLE Wi-Fi
up to 800 W
heating elements



ø 6 x 8 x 5 cm



Chrome/Black finish
Art. CIR-wifi 198,50€



e.KUAD

TECHNICAL DATA and other dimensions p. 176
ELECTRIC KIT DATA p. 208-209

e.KUAD has squared manifolds at front as standard.
State if the manifolds front side are curved

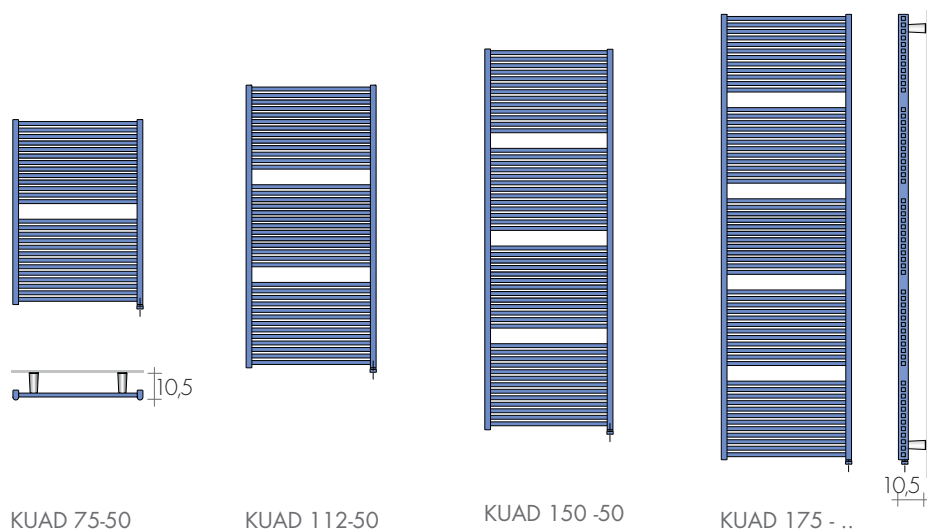

MODEL	H - L cm	Standard white sablé SB 9016 €	BREM Colors		KIT HEATING ELEMENT with:		
			+15% €	+25% €	Cable R..E Art. (W)	Faston R..T Art. (W)	€
KUAD	75-50	420,30	483,30	525,40	R400IIE	R400IIT	195,70
KUAD	112-50	627,20	721,30	784,00	R650IIE	R650IIT	222,90
KUAD	150-50	780,90	898,00	976,10	R800IIE	R800IIT	240,50
KUAD Slim	175-35	849,00	976,40	1061,30	R650IIE	R650IIT	222,90
KUAD	175-50	889,60	1023,00	1112,00	R900IIE	R900IIT	255,30

Towel heaters height = H - 4 cm (71-108,5-146-171cm)

HEATING ELEMENT POSITION
© Vertical Heating Element



THERMOSTATS Wi-Fi FOR KIT RE P. 208

ACCESSORIES FOR

E.H.E. white cable cover
or radiator color (together)
Art.CCRE38 ø3/8" 73,40€
Art.CCRE12 ø1/2" 73,40€



The KIT RT Wi-Fi includes:
- Thermostat RT (battery)
- Gateway
- Built-in receiver

Art. KITRT-wifi 199,80€

Additional receiver
(up to 6) radiators)



Art. SA868 64,20€

KIT ELY Wi-Fi TOP DESIGN includes:
- Thermostat with magnetic charging base
and magnetic plate for wall mounting
- Gateway a 230V
- Built-in Receiver

Art. KITELY-wifi 396,10€

Additional receiver: 1 for each electrical radiators
or split AC (up to 16)



Art. SA600 99,10€



TECHNICAL DATA and other dimensions p. 36
ELECTRIC KIT DATA p. 208-209

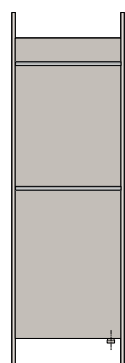
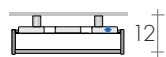

KUO 110..

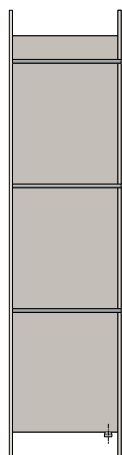

KUO 140..

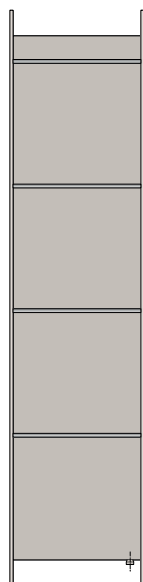

KUO 180..

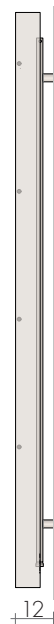

MODEL	H - L cm	Standard white	BREM Colors	BREM Colors	KIT HEATING ELEMENT with:		
		sablé SB 9016 €	+15% €	+25% €	Cable R..E Art. (W)	Faston R..T Art. (W)	€
KUO	110-25	591,00	679,70	738,80	R400IIE	R400IIT	195,70
KUO	110-35	664,70	764,40	830,90	R500IIE	R500IIT	208,50
KUO	140-25	676,30	777,70	845,40	R500IIE	R500IIT	208,50
KUO	140-35	775,30	891,60	969,10	R650IIE	R650IIT	222,90
KUO	140-42	918,30	1056,00	1147,90	R800IIE	R800IIT	240,50
KUO	180-25	845,80	972,70	1057,30	R650IIE	R650IIT	222,90
KUO	180-35	1013,40	1165,40	1266,80	R900IIE	R900IIT	255,30
KUO	180-42	1054,30	1212,40	1317,90	R1200IIE	R1200IIT	276,30

HEATING ELEMENT POSITION
© Vertical Heating Element



G

ELECTRIC VERSIONS

THERMOSTATS IN THE RADIATOR FOR KIT RT P. 209

THERMOSTAT mod. DYP



White with
white cable cover
Art. DYPB 89,60€

ø 7 x 9 x 5 cm



Black with
black cable cover
Art. DYPN 103,40€

REMOTE CONTROL for thermostats DYP

10,8 x 5,3 x 2,3 cm



Art. TIR 41,00€

THERMOSTAT CIRCLE Wi-Fi
up to 800 W
heating elements



ø 6 x 8 x 5 cm



Chrome/Black finish
Art. CIR-wifi 198,50€



TECHNICAL DATA and other dimensions p. 38
ELECTRIC KIT DATA p. 208-209

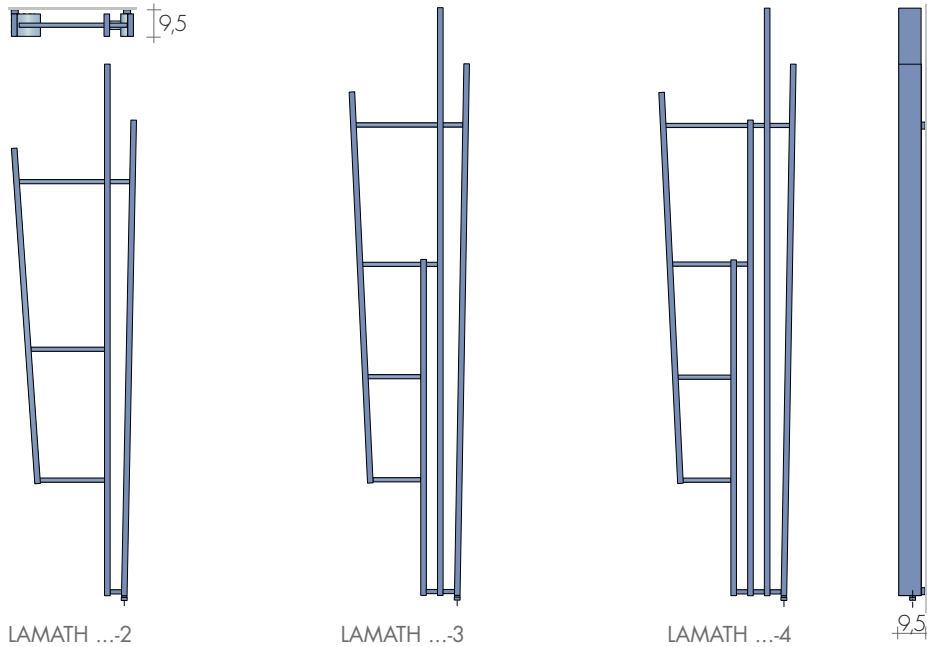

HEATING ELEMENT POSITION
© Vertical Heating Element

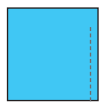

G

MODEL	H - n° cm-el	Standard white sablé SB 9016 €	BREM Colors		KIT HEATING ELEMENT with:		
			+15% €	+25% €	Cable R.E Art. (W)	Faston R.T Art. (W)	€
LAMATH	190-2	723,40	831,90	904,30	R400IIE	R400IIT	195,70
LAMATH	190-3	857,40	986,00	1071,80	R500IIE	R500IIT	208,50
LAMATH	190-4	991,90	1140,70	1239,90	R650IIE	R650IIT	222,90
LAMATH	210-2	774,60	890,80	968,30	R500IIE	R500IIT	208,50
LAMATH	210-3	927,10	1066,20	1158,90	R650IIE	R650IIT	222,90
LAMATH	210-4	1079,60	1241,50	1349,50	R800IIE	R800IIT	240,50

THERMOSTATS Wi-Fi FOR KIT RE P. 208

ACCESSORIES FOR

E.H.E. white cable cover
or radiator color (together)
Art.CCRE38 ø3/8" 73,40€
Art.CCRE12 ø1/2" 73,40€



The KIT RT Wi-Fi includes:
- Thermostat RT (battery)
- Gateway
- Built-in receiver

Art. KITRT-wifi 199,80€

Additional receiver
(up to 6) radiators)



Art. SA868 64,20€

KIT ELY Wi-Fi TOP DESIGN includes:
- Thermostat with magnetic charging base
and magnetic plate for wall mounting
- Gateway a 230V
- Built-in Receiver

Art. KITELY-wifi 396,10€

Additional receiver: 1 for each electrical radiators
or split AC (up to 16)



Art. SA600 99,10€



TECHNICAL DATA and other dimensions p. 10
ELECTRIC KIT DATA p. 208-209

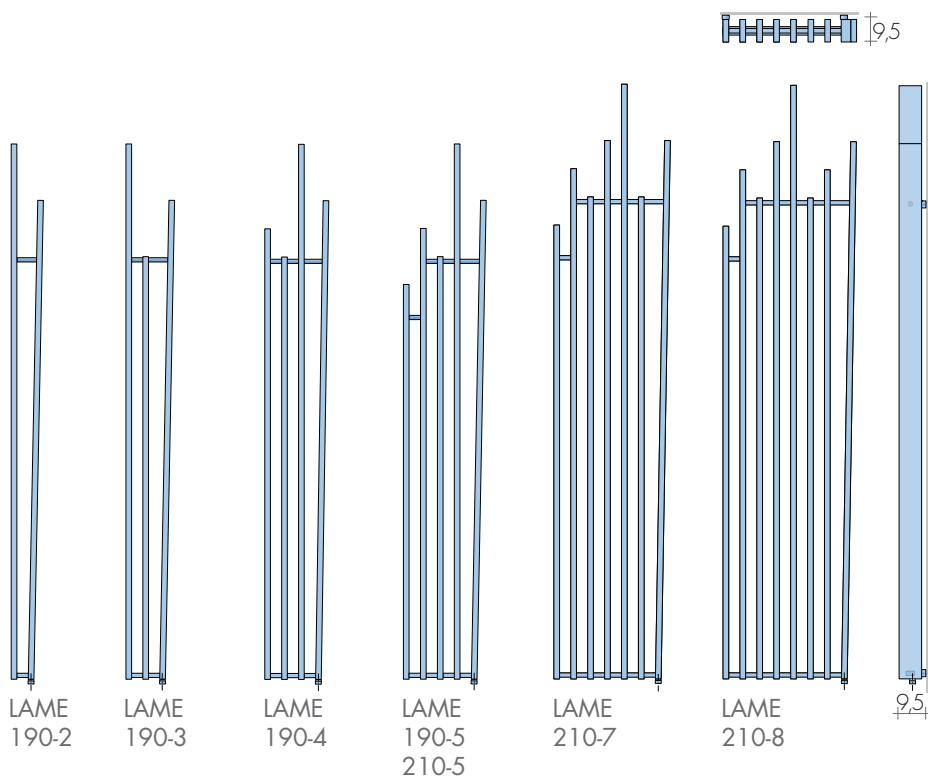

MODEL	H - n° cm-el	L cm	Standard white	BREM Colors	BREM Colors	KIT HEATING ELEMENT with:		
			sablé SB 9016 €	+15% €	+25% €	Cable R.E Art. (W)	Faston R.T Art. (W)	€
LAME 190-2	11	625,00	718,80	781,30	R400IIE	R400IIT	195,70	
LAME 190-3	17	768,40	883,70	960,50	R500IIE	R500IIT	208,50	
LAME 190-4	23	911,80	1048,60	1139,80	R650IIE	R650IIT	222,90	
LAME 190-5	29	1055,30	1213,60	1319,10	R800IIE	R800IIT	240,50	
LAME 190-6	35	1198,50	1378,30	1498,10	R900IIE	R900IIT	255,30	
LAME 210-5	29	1148,60	1320,90	1435,80	R900IIE	R900IIT	255,30	
LAME 210-7	41	1472,60	1693,50	1840,80	R1200IIE	R1200IIT	276,30	
LAME 210-8	47	1634,80	1880,00	2043,50	R1500IIE	R1500IIT	298,00	

HEATING ELEMENT POSITION
© Vertical Heating Element



ELECTRIC VERSIONS

THERMOSTATS IN THE RADIATOR FOR KIT RT P. 209

THERMOSTAT mod. DYP



White with
white cable cover
Art. DYPB 89,60€

ø 7 x 9 x 5 cm



Black with
black cable cover
Art. DYPN 103,40€

REMOTE CONTROL for thermostats DYP

10,8 x 5,3 x 2,3 cm



Art. TIR 41,00€

THERMOSTAT CIRCLE Wi-Fi
up to 800 W
heating elements



ø 6 x 8 x 5 cm



Chrome/Black finish
Art. CIR-wifi 198,50€



e.LAME SLIM

design Davide Brembilla

TECHNICAL DATA and other dimensions p. 40
ELECTRIC KIT DATA p. 208-209

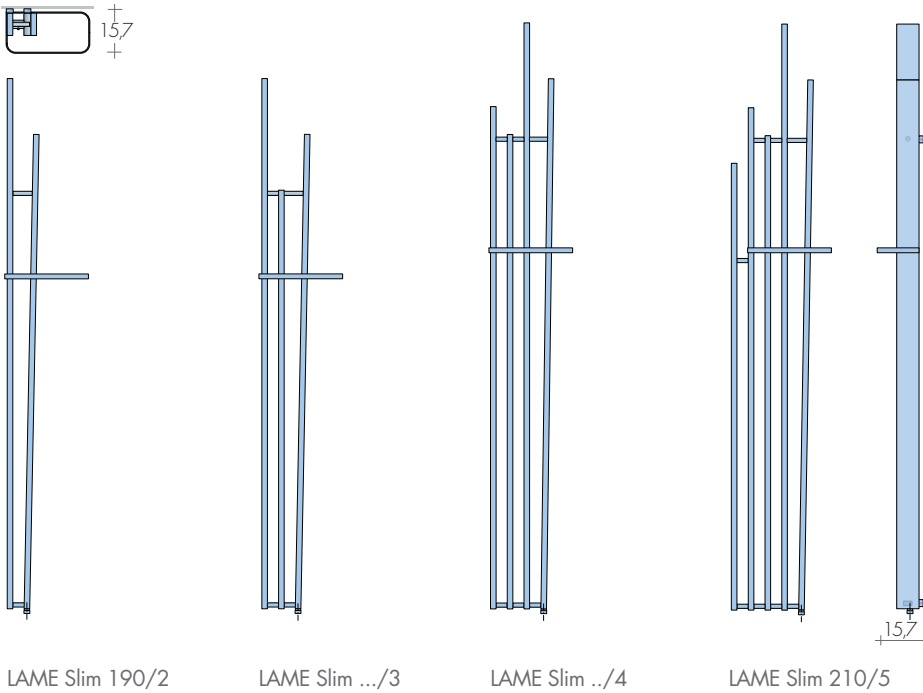

MODEL	H-n° cm-el	L cm	Standard white	BREM Colors	BREM Colors	KIT HEATING ELEMENT with:		
			sablé SB 9016 €	+15% €	+25% €	Cable R.E Art. (VV)	Faston R.T Art. (VV)	€
LAME SLIM 190/2	11		713,10	820,10	891,40	R400IIE	R400IIT	181,20
LAME SLIM 190/3	17		856,60	985,10	1070,80	R500IIE	R500IIT	193,10
LAME SLIM 190/4	23		999,80	1149,80	1249,80	R650IIE	R650IIT	206,40
LAME SLIM 210/3	17		918,70	1056,50	1148,40	R500IIE	R500IIT	208,50
LAME SLIM 210/4	23		1081,70	1244,00	1352,10	R800IIE	R800IIT	240,50
LAME SLIM 210/5	29		1259,30	1448,20	1574,10	R900IIE	R900IIT	255,30

Width with towel bar 30 cm, and 36 cm for mod 210/5



HEATING ELEMENT POSITION
© Vertical Heating Element

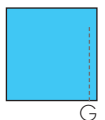

G

THERMOSTATS IN THE RADIATOR FOR KIT RT P.209 ACCESSORIES FOR

THERMOSTAT mod. DYP



White with white cable cover
Art. DYPB 89,60€

ø 7 x 9 x 5 cm



Black with black cable cover
Art. DYPN 103,40€

REMOTE CONTROL for thermostats DYP

10,8 x 5,3 x 2,3 cm



Art. TIR 41,00€

THERMOSTAT CIRCLE Wi-Fi
up to 800 W
heating elements



ø 6 x 8 x 5 cm



Chrome/Black finish
Art. CIR-wifi 198,50€



e.LAME-UP

design Davide Brembilla

TECHNICAL DATA and other dimensions p. 12
ELECTRIC KIT DATA p. 208-209

Standard position on the short side
On request: position on the long side
Extra Art. LAME-UPL 72,50€

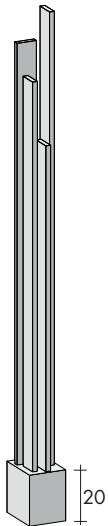
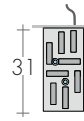
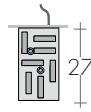
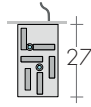
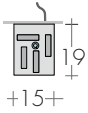

LAME-UP
200-4

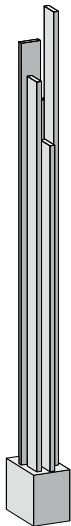

LAME-UP
200-5

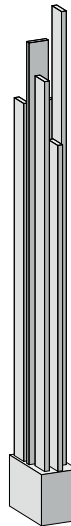

LAME-UP
200-6

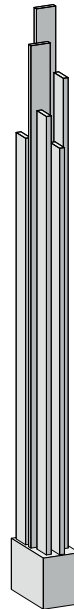

LAME-UP
230-6

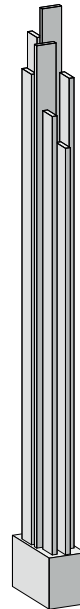

LAME-UP
200-8
230-8

MODEL	H - L cm	Standard white sablé SB 9016 €	BREM Colors +15% €	BREM Colors +25% €	KIT HEATING ELEMENT with:		
					Cable R.E Art. (W)	Faston R.T Art. (W)	€
LAME-UP	200-4	1032,60	1187,50	1290,80	R650IIE	-	222,90
LAME-UP	200-5	1279,00	1470,90	1598,80	R800IIE	-	240,50
LAME-UP	200-6	1449,80	1667,30	1812,30	R900IIE	-	255,30
LAME-UP	200-8	1862,70	2142,10	2328,40	R1200IIE	-	276,30
LAME-UP	230-6	1572,40	1808,30	1965,50	R1200IIE	-	276,30
LAME-UP	230-8	2010,00	2311,50	2512,50	R1500IIE	-	298,00
led light page 12 n.1		Art. F.LED1	65,00€	ONLY with Wi-Fi THERMOSTATS for KIT RE			
n.2		Art. F.LED2	108,20€				



HEATING ELEMENT POSITION
© Vertical Heating Element



ELECTRIC VERSIONS

THERMOSTATS Wi-Fi FOR KIT RE P. 208

E.H.E. white cable cover
or radiator color (together)
Art.CCRE38 ø3/8" 73,40€
Art.CCRE12 ø1/2" 73,40€



The KIT RT Wi-Fi includes:
- Thermostat RT (battery)
- Gateway
- Built-in receiver

Art. KITRT-wifi 199,80€

Additional receiver
(up to 6) radiators)

Art. SA868 64,20€



KIT ELY Wi-Fi TOP DESIGN includes:
- Thermostat with magnetic charging base
and magnetic plate for wall mounting
- Gateway a 230V
- Built-in Receiver

Art. KITELY-wifi 396,10€

Additional receiver: 1 for each electrical radiators
or split AC (up to 16) Art. SA600 99,10€



TECHNICAL DATA and other dimensions p. 178
ELECTRIC KIT DATA p. 208-209

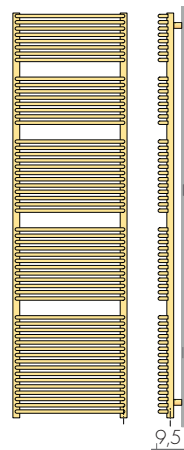
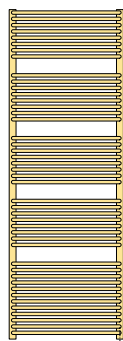
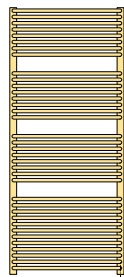
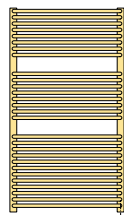
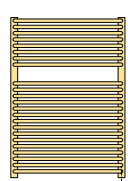

MAHN 70-50

MAHN 90-50

MAHN 120-50

MAHN 150-50

MAHN 180-..



HEATING ELEMENT POSITION
© Vertical Heating Element



G

MODEL	H - L cm	Standard white	BREM Colors	BREM Colors	KIT HEATING ELEMENT with:		
		sablé SB 9016 €	+15% €	+25% €	Cable R.E Art. (W)	Faston R.T Art. (W)	€
MAHN	70-50	584,00	671,60	730,00	R400IIE	R400IIT	195,70
MAHN	90-50	742,70	854,10	928,40	R500IIE	R500IIT	208,50
MAHN	120-50	883,60	1016,10	1104,50	R650IIE	R650IIT	222,90
MAHN	150-50	1047,30	1204,40	1309,10	R800IIE	R800IIT	240,50
Slim-MAHN	180-28	1135,30	1305,60	1419,10	R650IIE	R650IIT	222,90
MAHN	180-60	1302,20	1497,50	1627,80	R1200IIE	R1200IIT	276,30

THERMOSTATS Wi-Fi FOR KIT RE P. 208

ACCESSORIES FOR

E.H.E. white cable cover
or radiator color (together)
Art.CCRE38 ø3/8" 73,40€
Art.CCRE12 ø1/2" 73,40€



The KIT RT Wi-Fi includes:
- Thermostat RT (battery)
- Gateway
- Built-in receiver

Art. KITRT-wifi 199,80€

Additional receiver
(up to 6) radiators)

Art. SA868 64,20€



KIT ELY Wi-Fi TOP DESIGN includes:
- Thermostat with magnetic charging base
and magnetic plate for wall mounting
- Gateway a 230V
- Built-in Receiver

Art. KITELY-wifi 396,10€

Additional receiver: 1 for each electrical radiators
or split AC (up to 16) Art. SA600 99,10€



e.MAHN-AIR

TECHNICAL DATA and other dimensions p. 180
ELECTRIC KIT DATA p. 208-209

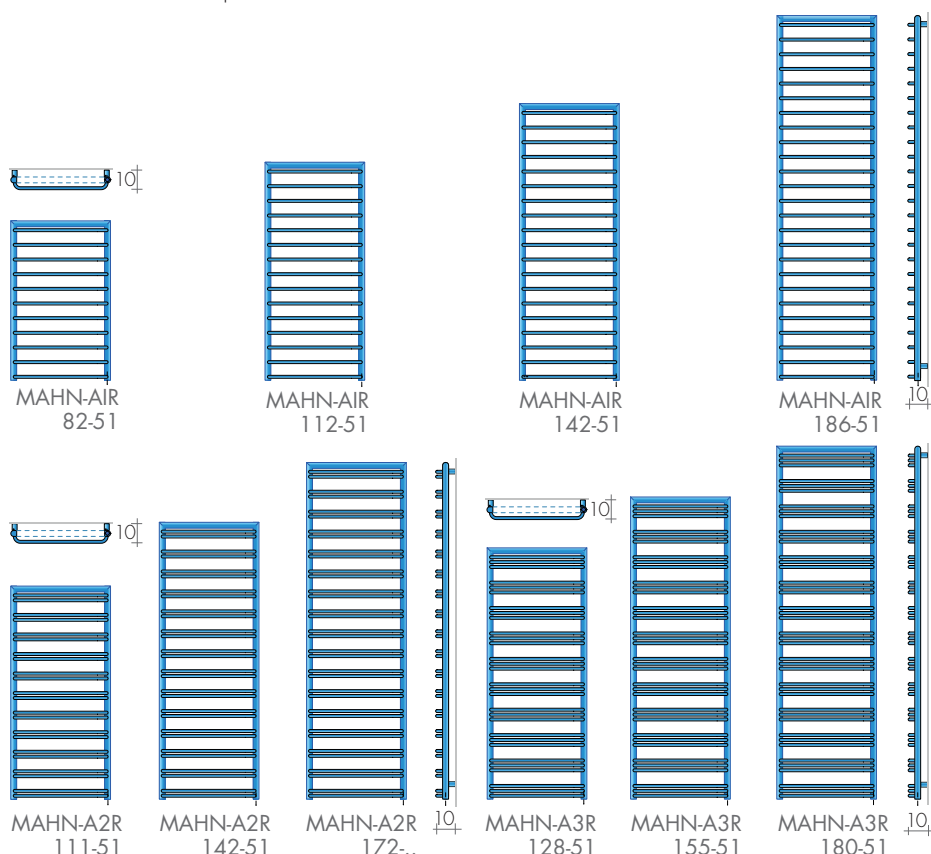

MODEL	H - L cm	Standard white	BREM Colors	BREM Colors	KIT HEATING ELEMENT with:		
		sablé SB 9016 €	+15% €	+25% €	Cable R..E Art. (W)	Faston R..T Art. (W)	€
MAHN-AIR	82-51	525,50	604,30	656,90	R300IIE	R300IIT	193,80
MAHN-AIR	112-51	594,20	683,30	742,80	R400IIE	R400IIT	195,70
MAHN-AIR	142-51	751,00	863,70	938,80	R500IIE	R500IIT	208,50
MAHN-AIR	186-51	867,10	997,20	1083,90	R650IIE	R650IIT	222,90
MAHN-A2R	111-51	705,50	811,30	881,90	R500IIE	R500IIT	208,50
MAHN-A2R	142-51	839,30	965,20	1049,10	R650IIE	R650IIT	222,90
MAHN-A2R	172-51	929,00	1068,40	1161,30	R800IIE	R800IIT	240,50
MAHN-A2R	172-61	976,60	1123,10	1220,80	R900IIE	R900IIT	255,30
MAHN-A3R	128-51	861,80	991,10	1077,30	R650IIE	R650IIT	222,90
MAHN-A3R	155-51	942,50	1083,90	1178,10	R800IIE	R800IIT	240,50
MAHN-A3R	180-51	1012,70	1164,60	1265,90	R900IIE	R900IIT	255,30

CHROME HOOK, only Mahn-A2R et A3R
(ø 3 x 3,5 cm)p.277 Art. AC n°2 90,90€



HEATING ELEMENT POSITION
© Vertical Heating Element



ELECTRIC VERSIONS

THERMOSTATS IN THE RADIATOR FOR KIT RT P. 209

THERMOSTAT mod. DYP



White with
white cable cover
Art. DYPB 89,60€

ø 7 x 9 x 5 cm



Black with
black cable cover
Art. DYPN 103,40€

REMOTE CONTROL for thermostats DYP

10,8 x 5,3 x 2,3 cm



Art. TIR 41,00€

THERMOSTAT CIRCLE Wi-Fi
up to 800 W
heating elements



ø 6 x 8 h x 5 cm



Chrome/Black finish
Art. CIR-wifi 198,50€



TECHNICAL DATA and other dimensions p. 138
ELECTRIC KIT DATA p. 208-209

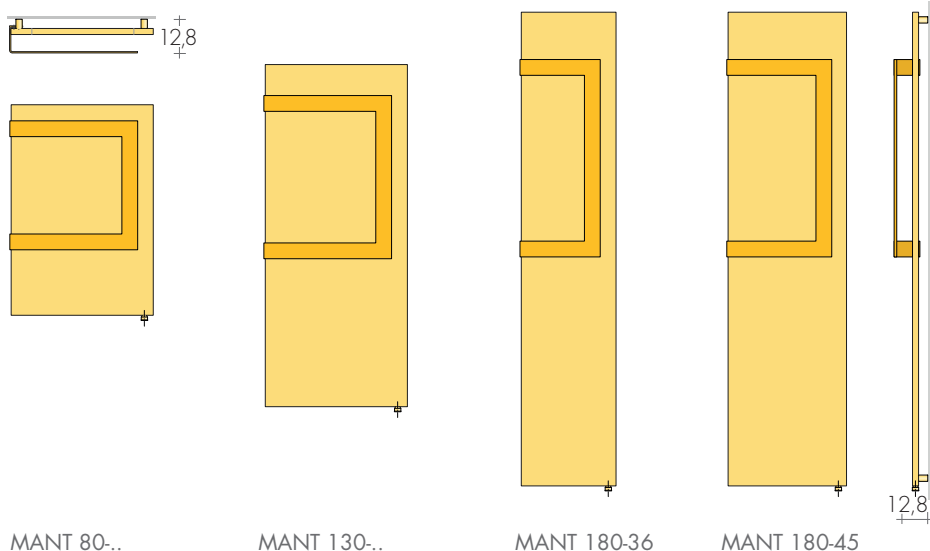

MODEL	H - L cm	Standard white	BREM Colors	BREM Colors	KIT HEATING ELEMENT with:		
		sablé SB 9016 €	+15% €	+25% €	Cable R.E Art. (W)	Faston R.T Art. (W)	€
MANT	80-45	862,70	992,10	1078,40	R400IIE	R400IIT	195,70
MANT	80-54	940,50	1081,60	1175,60	R500IIE	R500IIT	208,50
MANT	130-45	1032,50	1187,40	1290,60	R650IIE	R650IIT	222,90
MANT	130-54	1121,20	1289,40	1401,50	R800IIE	R800IIT	240,50
MANT	180-36	1100,10	1265,10	1375,10	R650IIE	R650IIT	222,90
MANT	180-45	1202,30	1382,60	1502,90	R900IIE	R900IIT	255,30

TOWEL BAR MANT: STANDARD COLORS
 - white sablé SB 9016 - quartz grey SB 7039
 - black sablé SB 9005 - same color as the radiator
 In one paintwork to Brem color list different from the radiator
 Extra Art. CM 52,90€

On request, free of charge, the bar on the right

HEATING ELEMENT POSITION
 ☉ Vertical Heating Element

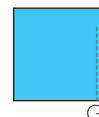

THERMOSTATS Wi-Fi FOR KIT RE P. 208

ACCESSORIES FOR

E.H.E. white cable cover
or radiator color (together)
Art.CCRE38 ø3/8" 73,40€
Art.CCRE12 ø1/2" 73,40€



The KIT RT Wi-Fi includes:
 - Thermostat RT (battery)
 - Gateway
 - Built-in receiver

Art. KITRT-wifi 199,80€

Additional receiver
(up to 6) radiators)



Art. SA868 64,20€

KIT ELY Wi-Fi TOP DESIGN includes:
 - Thermostat with magnetic charging base
and magnetic plate for wall mounting
- Gateway a 230V
- Built-in Receiver

Art. KITELY-wifi 396,10€

Additional receiver: 1 for each electrical radiators
or split AC (up to 16) Art. SA600 99,10€



e.PHUL

TECHNICAL DATA and other dimensions p. 106
ELECTRIC KIT DATA p. 208-209

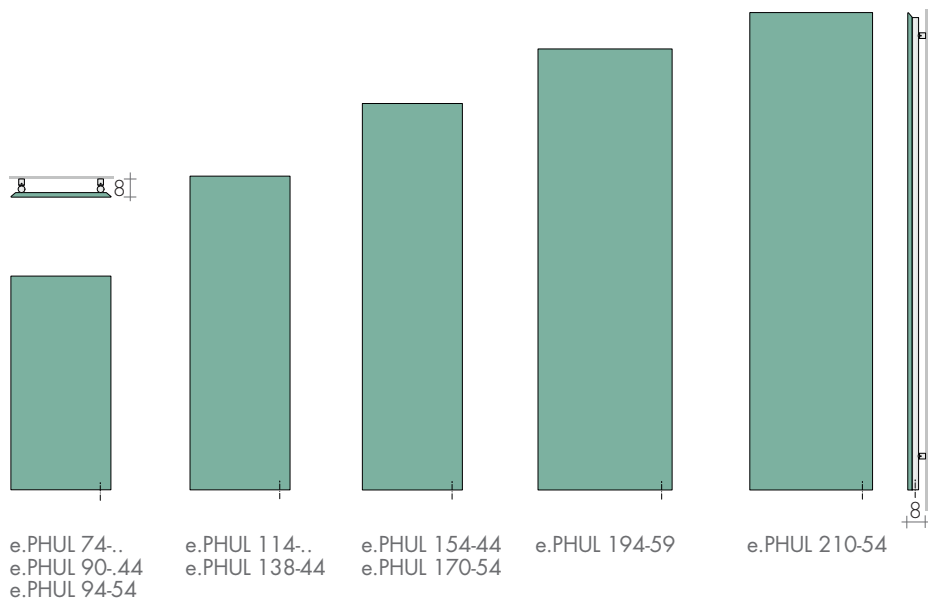

RAM
page 277

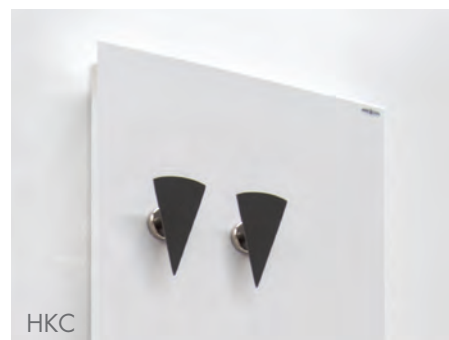

MODEL'25	H-L cm	Standard white	BREM Colors	BREM Colors	KIT HEATING ELEMENT with:		
		sablé SB 9016 €	+15% €	+25% €	Cable R.E Art. (WV)	Faston R.T Art. (WV)	€
PHUL	74-44	607,90	699,10	759,90	R400IIE	R400IIT	195,70
PHUL	74-54	667,10	767,20	833,90	R500IIE	R500IIT	208,50
PHUL	90-44	684,30	786,90	855,40	R500IIE	R500IIT	208,50
PHUL	94-54	726,30	835,20	907,90	R650IIE	R650IIT	222,90
PHUL	114-44	746,90	858,90	933,60	R650IIE	R650IIT	222,90
PHUL	114-54	795,80	915,20	994,80	R800IIE	R800IIT	240,50
PHUL	138-44	821,10	944,30	1026,40	R800IIE	R800IIT	240,50
PHUL	154-44	866,40	996,40	1083,00	R900IIE	R900IIT	255,30
PHUL	170-54	1077,10	1238,70	1346,40	R1200IIE	R1200IIT	276,30
PHUL	194-59	1256,30	1444,70	1570,40	R1500IIE	R1500IIT	298,00
PHUL	210-54	1281,40	1473,60	1601,80	R1500IIE	R1500IIT	298,00

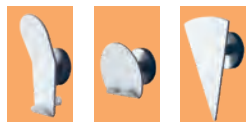

KNOBS with magnet
page 277

TOWEL BAR MAGNET
page 277

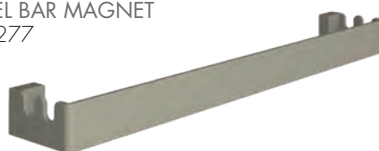

HEATING ELEMENT POSITION
© Vertical Heating Element



ELECTRIC VERSIONS

THERMOSTATS IN THE RADIATOR FOR KIT RT P. 209

THERMOSTAT mod. DYP



White with
white cable cover
Art. DYPB 89,60€

ø 7 x 9 x 5 cm



Black with
black cable cover
Art. DYPN 103,40€

REMOTE CONTROL for thermostats DYP

10,8 x 5,3 x 2,3 cm



Art. TIR 41,00€

THERMOSTAT CIRCLE Wi-Fi
up to 800 W
heating elements



ø 6 x 8 x 5 cm



Chrome/Black finish
Art. CIR-wifi 198,50€



TECHNICAL DATA and other dimensions p. 78
ELECTRIC KIT DATA p. 208-209

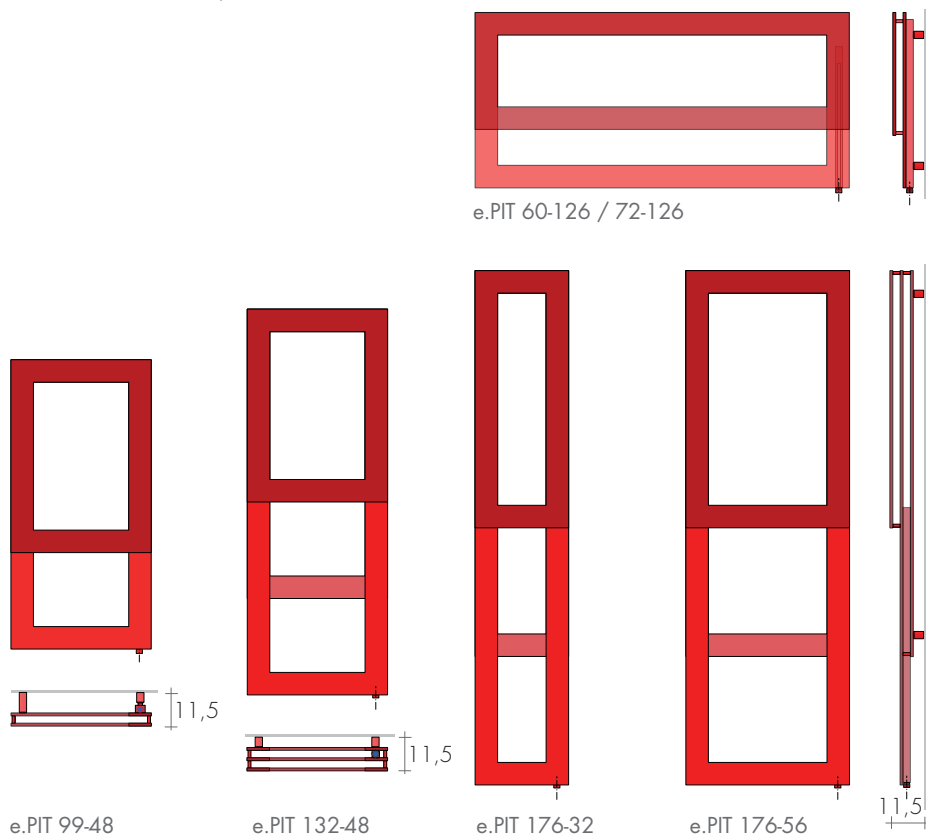

MODEL	H - L cm	Standard white sablé SB 9016 €	BREM Colors +15% €	BREM Colors +25% €	KIT HEATING ELEMENT with:		
					Cable R.E Art. (W)	Faston R.T Art. (W)	€
e.PIT 60-126		1093,80	1257,90	1367,30	R650IIE	R650IIT	222,90
e.PIT 72-126		1314,30	1511,40	1642,90	R900IIE	R900IIT	255,30
e.PIT 99-48		849,90	977,40	1062,40	R400IIE	R400IIT	195,70
e.PIT 132-48		1153,90	1327,00	1442,40	R650IIE	R650IIT	222,90
e.PIT 176-32		1237,80	1423,50	1547,30	R800IIE	R800IIT	240,50
e.PIT 176-56		1344,30	1545,90	1680,40	R900IIE	R900IIT	255,30

Prices include the additional manifold

HEATING ELEMENT POSITION
© Vertical Heating Element



G

THERMOSTATS Wi-Fi FOR KIT RE P. 208

ACCESSORIES FOR

E.H.E. white cable cover
or radiator color (together)
Art.CCRE38 ø3/8" 73,40€
Art.CCRE12 ø1/2" 73,40€



The KIT RT Wi-Fi includes:
- Thermostat RT (battery)
- Gateway
- Built-in receiver

Art. KITRT-wifi 199,80€

Additional receiver
(up to 6) radiators)

Art. SA868 64,20€



KIT ELY Wi-Fi TOP DESIGN includes:
- Thermostat with magnetic charging base
and magnetic plate for wall mounting
- Gateway a 230V
- Built-in Receiver

Art. KITELY-wifi 396,10€

Additional receiver: 1 for each electrical radiators
or split AC (up to 16) Art. SA600 99,10€



e.PLANK e.Plank-AIR

TECHNICAL DATA and other dimensions p. 182,184
ELECTRIC KIT DATA p. 208-209

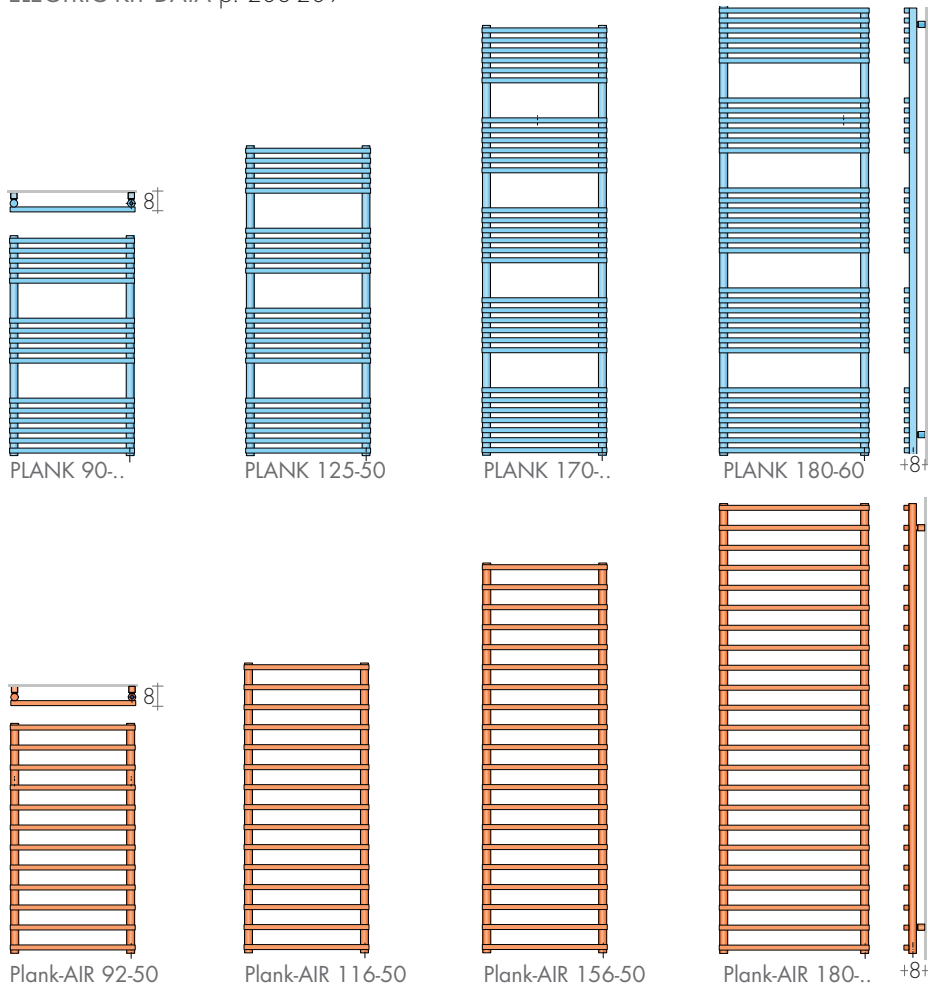

MODEL	H - L cm	Standard white	BREM Colors	BREM Colors	KIT HEATING ELEMENT with:		
		RAL 9016 €	+15% €	+25% €	Cable R.E Art. (W)	Faston R.T Art. (W)	€
PLANK	90-40	365,80	420,70	457,30	R400IIE	R400IIT	195,70
PLANK	90-50	379,70	436,70	474,60	R500IIE	R500IIT	208,50
PLANK	125-50	506,40	582,40	633,00	R650IIE	R650IIT	222,90
PLANK	170-40	669,80	770,30	837,30	R800IIE	R800IIT	240,50
PLANK	170-50	696,20	800,60	870,30	R900IIE	R900IIT	255,30
PLANK	180-60	763,70	878,30	954,60	R1200IIE	R1200IIT	276,30
Plank-AIR	92-50	352,90	405,80	441,10	R400IIE	R400IIT	195,70
Plank-AIR	116-50	446,10	513,00	557,60	R500IIE	R500IIT	208,50
Plank-AIR	156-50	528,40	607,70	660,50	R650IIE	R650IIT	222,90
Plank-AIR	180-50	610,80	702,40	763,50	R800IIE	R800IIT	240,50
Plank-AIR	180-60	649,20	746,60	811,50	R900IIE	R900IIT	255,30

HEATING ELEMENT POSITION
© Vertical Heating Element



ELECTRIC VERSIONS

THERMOSTATS IN THE RADIATOR FOR KIT RT P. 209

THERMOSTAT mod. DYP



White with white cable cover
Art. DYPB 89,60€

ø 7 x 9 x 5 cm



Black with black cable cover
Art. DYPN 103,40€

REMOTE CONTROL for thermostats DYP

10,8 x 5,3 x 2,3 cm



Art. TIR 41,00€

THERMOSTAT CIRCLE Wi-Fi
up to 800 W
heating elements



ø 6 x 8 h x 5 cm



Chrome/Black finish
Art. CIR-wifi 198,50€



e.PLATT

COLOR/INOX/GILDED-SILVER LEAF

TECHNICAL DATA and other dimensions p.140-143
ELECTRIC KIT DATA p. 208-209

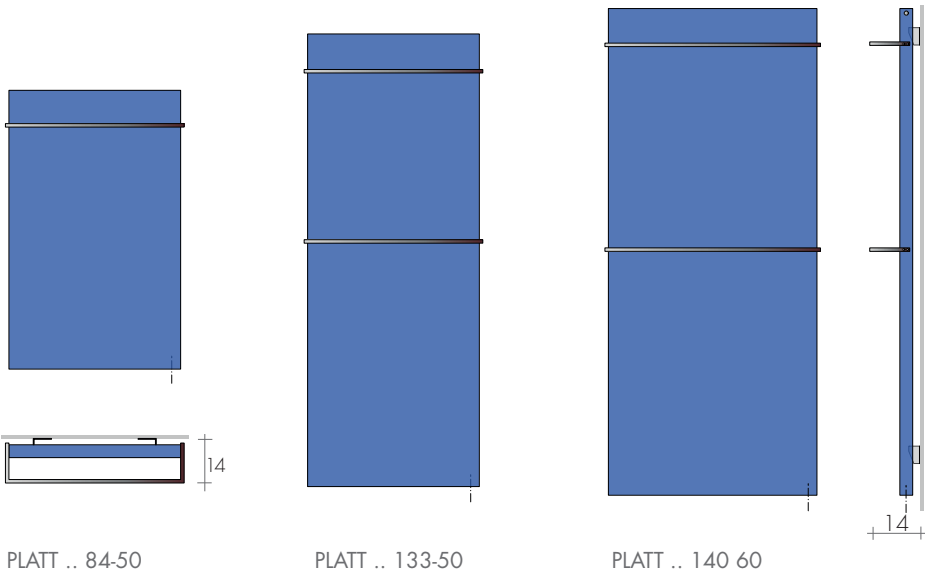

MODEL	H - L cm	Standard white	BREM Colors	BREM Colors	KIT HEATING ELEMENT with:		
		sablé SB 9016 €	+15% €	+25% €	Cable R..E Art. (W)	Faston R..T Art. (W)	€
Platt COLOR 84-50	84-50	853,40	981,40	1066,80	R400IIE	R400IIT	195,70
Platt COLOR 133-50	133-50	1154,10	1327,20	1442,60	R650IIE	R650IIT	222,90
Platt COLOR 140-60	140-60	1306,90	1502,90	1633,60	R800IIE	R800IIT	240,50
PLATT INOX SATIN							
Platt INOX 84-50	84-50	1247,40	-	-	R400IIE	R400IIT	195,70
Platt INOX 133-50	133-50	1635,90	-	-	R650IIE	R650IIT	222,90
Platt INOX 140-60	140-60	1734,70	-	-	R800IIE	R800IIT	240,50
FO GILDED LEAF/ FA SILVER LEAF							
Platt FO/FA 84-50	84-50	1613,00	-	-	R400IIE	R400IIT	195,70
Platt FO/FA 133-50	133-50	2130,70	-	-	R650IIE	R650IIT	222,90
Platt FO/FA 140-60	140-60	2417,80	-	-	R800IIE	R800IIT	240,50

TOWEL BAR PLATT: STANDARD COLORS
- white sablé SB 9016 - quartz grey SB 7039
- black sablé SB 9005 - same color as the radiator
In one paintwork to Brem color list different from the radiator
Extra Art. CM 52,90€

Towel bar in BR0019 color for gilded leaf, in BR0002 color for silver leaf as standard.
Gilded/silver leaf towel bar Extra (each) 150,90€
Chrome-plated towel bar as standard for Platt Color

HEATING ELEMENT POSITION
© Vertical Heating Element

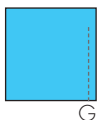

THERMOSTATS Wi-Fi FOR KIT RE P. 208

ACCESSORIES FOR



E.H.E. white cable cover or radiator color (together)
Art.CCRE38 ø3/8" 73,40€
Art.CCRE12 ø1/2" 73,40€

The KIT RT Wi-Fi includes:
- Thermostat RT (battery)
- Gateway
- Built-in receiver

Art. KITRT-wifi 199,80€

Additional receiver (up to 6) radiators)



Art. SA868 64,20€

KIT ELY Wi-Fi TOP DESIGN includes:
- Thermostat with magnetic charging base and magnetic plate for wall mounting
- Gateway a 230V
- Built-in Receiver

Art. KITELY-wifi 396,10€

Additional receiver: 1 for each electrical radiators or split AC (up to 16) Art. SA600 99,10€



e.PLUS 12

TECHNICAL DATA and other dimensions p. 186
ELECTRIC KIT DATA p. 208-209

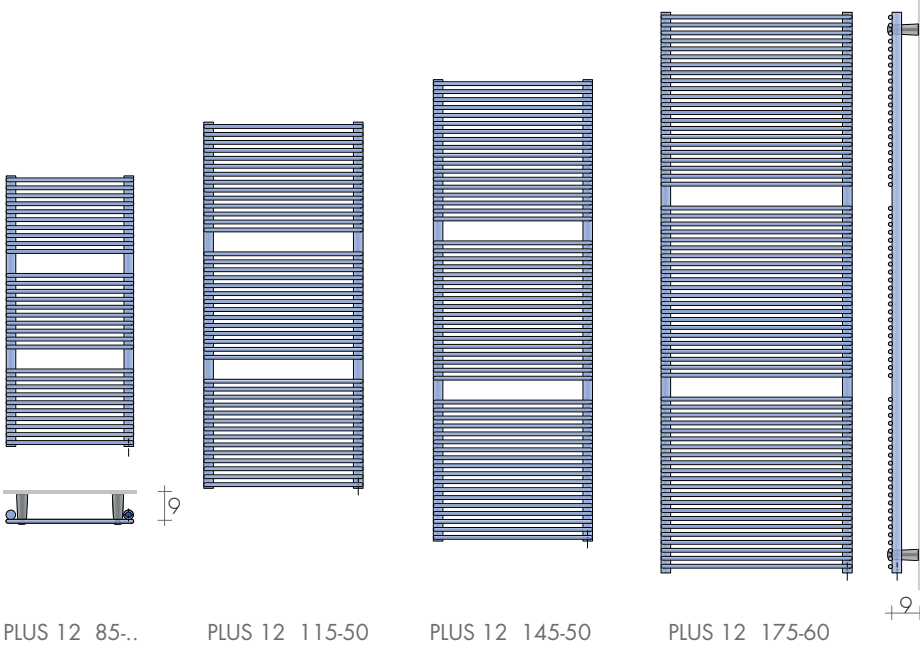

PLUS 12 85-..

PLUS 12 115-50

PLUS 12 145-50

PLUS 12 175-60

MODEL'25	H - L cm	Standard satin white SB 9016 €	BREM Colors +15% €	BREM Colors +25% €	KIT HEATING ELEMENT with:		
					Cable R..E Art. (W)	Faston R..T Art. (W)	€
PLUS 12	85-40	394,10	453,20	492,60	R400IIE	R400IIT	195,70
PLUS 12	85-50	401,50	461,70	501,90	R500IIE	R500IIT	208,50
PLUS 12	115-50	576,90	663,40	721,10	R650IIE	R650IIT	222,90
PLUS 12	145-50	662,60	762,00	828,30	R800IIE	R800IIT	240,50
PLUS 12	175-60	788,50	906,80	985,60	R1200IIE	R1200IIT	276,30

CHROME HOOK
ø3 x 3,5 cm, p. 277

Art. AC n°2 90,90€



HEATING ELEMENT POSITION
© Vertical Heating Element

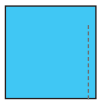

ELECTRIC VERSIONS

THERMOSTATS IN THE RADIATOR FOR KIT RT P. 209

THERMOSTAT mod. DYP



White with
white cable cover
Art. DYPB 89,60€

ø 7 x 9 x 5 cm



Black with
black cable cover
Art. DYPN 103,40€

REMOTE CONTROL for thermostats DYP

10,8 x 5,3 x 2,3 cm



Art. TIR 41,00€

THERMOSTAT CIRCLE Wi-Fi
up to 800 W
heating elements



ø 6 x 8 x 5 cm



Chrome/Black finish
Art. CIR-wifi 198,50€



e.PLUS 18 e.Plus-AIR

TECHNICAL DATA and other dimensions p. 188-190
ELECTRIC KIT DATA p. 208-209

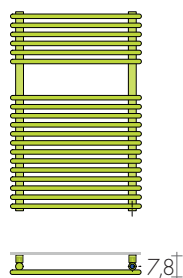

PLUS 18 80-52

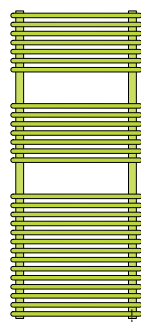

PLUS 18 125-52

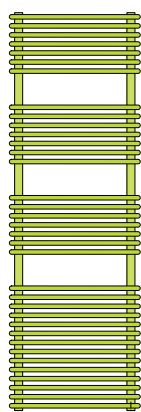

PLUS 18 160-52

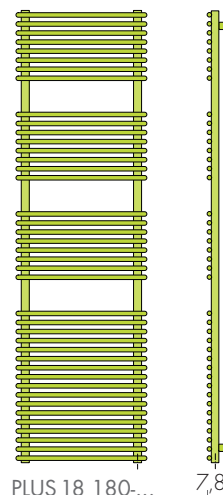

PLUS 18 180-52

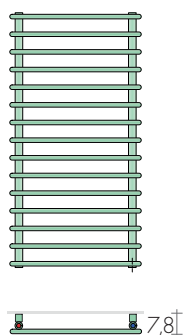

PLUS-AIR 101-52

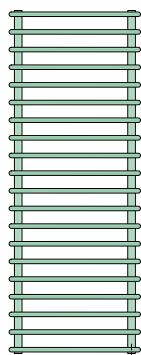

PLUS-AIR 136-52

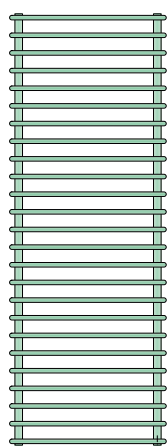

PLUS-AIR 171-52

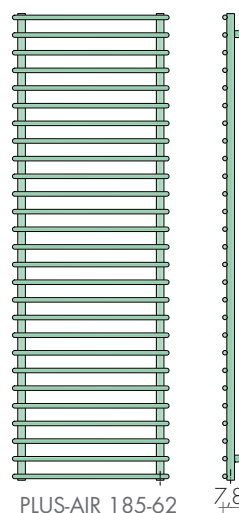

PLUS-AIR 185-62



HEATING ELEMENT POSITION
© Vertical Heating Element

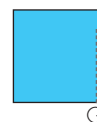

MODEL	H - L cm	Standard white	BREM Colors	BREM Colors	KIT HEATING ELEMENT with:		
		sablé SB 9016 €	+15% €	+25% €	Cable R..E Art. (W)	Faston R..T Art. (W)	€
PLUS 18	80-52	302,40	347,80	378,00	R400IIE	R400IIT	195,70
PLUS 18	125-42	379,70	436,70	474,60	R500IIE	R500IIT	208,50
PLUS 18	125-52	393,80	452,90	492,30	R650IIE	R650IIT	222,90
PLUS 18	160-52	478,10	549,80	597,60	R800IIE	R800IIT	240,50
PLUS 18	180-52	562,60	647,00	703,30	R900IIE	R900IIT	255,30
PLUS 18	180-62	586,50	674,50	733,10	R1200IIE	R1200IIT	276,30
PLUS-AIR	101-42	322,80	371,20	403,50	R300IIE	R300IIT	193,80
PLUS-AIR	101-52	334,80	385,00	418,50	R400IIE	R400IIT	195,70
PLUS-AIR	136-42	368,40	423,70	460,50	R400IIE	R400IIT	195,70
PLUS-AIR	136-52	382,00	439,30	477,50	R500IIE	R500IIT	208,50
PLUS-AIR	171-52	435,10	500,40	543,90	R650IIE	R650IIT	222,90
PLUS-AIR	185-62	498,60	573,40	623,30	R800IIE	R800IIT	240,50

THERMOSTATS Wi-Fi FOR KIT RE P. 208

ACCESSORIES FOR



E.H.E. white cable cover
or radiator color (together)
Art.CCRE38 ø3/8" 73,40€
Art.CCRE12 ø1/2" 73,40€

The KIT RT Wi-Fi includes:
- Thermostat RT (battery)
- Gateway
- Built-in receiver

Art. KITRT-wifi 199,80€

Additional receiver
(up to 6) radiators)



Art. SA868 64,20€

KIT ELY Wi-Fi TOP DESIGN includes:
- Thermostat with magnetic charging base
and magnetic plate for wall mounting
- Gateway a 230V
- Built-in Receiver

Art. KITELY-wifi 396,10€

Additional receiver: 1 for each electrical radiators
or split AC (up to 16) Art. SA600 99,10€



TECHNICAL DATA and other dimensions p. 80
ELECTRIC KIT DATA p. 208-209

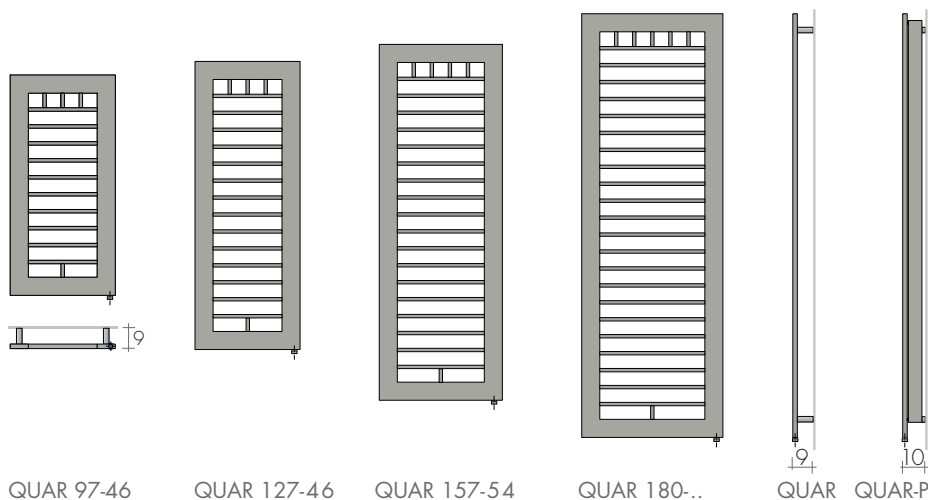

QUAR 97-46 QUAR 127-46 QUAR 157-54 QUAR 180-62 QUAR 180-38 QUAR-P



HEATING ELEMENT POSITION
© Vertical Heating Element



MODEL	H - L cm	Standard white	BREM Colors	BREM Colors	KIT HEATING ELEMENT with:		
		sablé SB 9016 €	+15% €	+25% €	Cable R.E Art. (W)	Faston R.T Art. (W)	€
QUAR	97-46	868,10	998,30	1085,10	R400IIE	R400IIT	195,70
QUAR	127-46	936,50	1077,00	1170,60	R500IIE	R500IIT	208,50
QUAR	157-54	1060,90	1220,00	1326,10	R650IIE	R650IIT	222,90
QUAR-P	157-54	1318,00	1515,70	1647,50	R900IIE	R900IIT	255,30
QUAR	180-62	1204,60	1385,30	1505,80	R800IIE	R800IIT	240,50
QUAR-P	180-38	1388,70	1597,00	1735,90	R900IIE	R900IIT	255,30
QUAR-P	180-62	1461,80	1681,10	1827,30	R1200IIE	R1200IIT	276,30

ELECTRIC VERSIONS

THERMOSTATS IN THE RADIATOR FOR KIT RT P. 209

THERMOSTAT mod. DYP



White with
white cable cover
Art. DYPB 89,60€

ø 7 x 9 x 5 cm



Black with
black cable cover
Art. DYPN 103,40€

REMOTE CONTROL for thermostats DYP

10,8 x 5,3 x 2,3 cm



Art. TIR 41,00€

THERMOSTAT CIRCLE Wi-Fi
up to 800 W
heating elements



ø 6 x 8 x 5 cm



Chrome/Black finish
Art. CIR-wifi 198,50€



TECHNICAL DATA and other dimensions p. 192 and 194
ELECTRIC KIT DATA p. 208-209
Below, the main dimensions for bathrooms.

HORIZONTAL MODELS

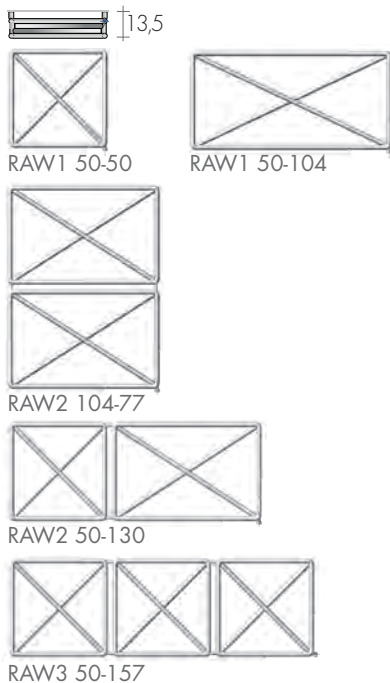

VERTICAL MODELS

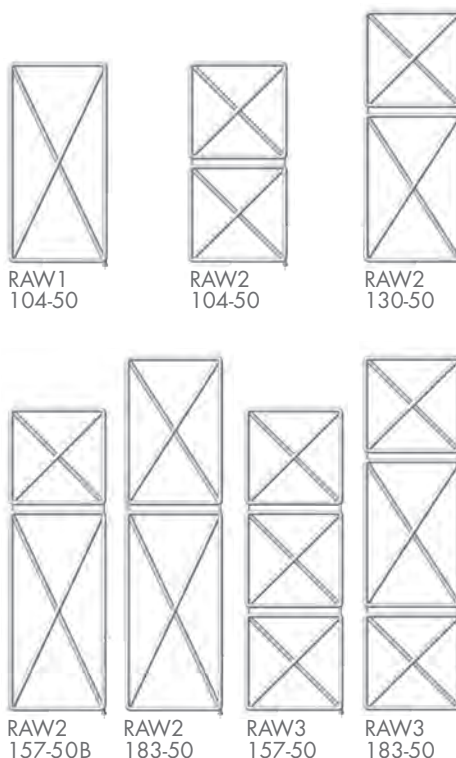

MODEL	H - L cm	Standard white sablé SB 9016 €	BREM Colors		KIT HEATING ELEMENT with:		
			+15% €	+25% €	Cable R..E Art. (W)	Faston R..T Art. (W)	€
HORIZONTAL MODELS							
RAW1	50-50	632,90	727,80	791,10	R300IIE	R300IIT	193,80
RAW1	50-104	815,80	938,20	1019,80	R400IIE	R400IIT	195,70
RAW2	50-130	1118,10	1285,80	1397,60	R650IIE	R650IIT	222,90
RAW3*	50-157	1476,80	1698,30	1846,00	R800IIE	R800IIT	240,50
VERTICAL MODELS							
RAW1	104-50	815,80	938,20	1019,80	R400IIE	R400IIT	195,70
RAW2	104-50	1054,90	1213,10	1318,60	R500IIE	R500IIT	208,50
RAW2	104-77	1181,40	1358,60	1476,80	R800IIE	R800IIT	240,50
RAW2	130-50	1118,10	1285,80	1397,60	R650IIE	R650IIT	222,90
RAW2	157-50B	1181,40	1358,60	1476,80	R800IIE	R800IIT	240,50
RAW2	183-50	1216,50	1399,00	1520,60	R800IIE	R800IIT	240,50
RAW3	157-50	1476,80	1698,30	1846,00	R900IIE	R900IIT	255,30
RAW3	183-50	1504,90	1730,60	1881,10	R900IIE	R900IIT	255,30

* Horizontal Heating El.

On request, RAW module compositions according to design



HEATING EL. POSITION
Ⓓ Horizontal Heating El.
Ⓒ Vertical Heating Element

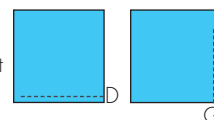

THERMOSTATS Wi-Fi FOR KIT RE P. 208

ACCESSORIES FOR

E.H.E. white cable cover
or radiator color (together)
Art.CCRE38 ø3/8" 73,40€
Art.CCRE12 ø1/2" 73,40€



The KIT RT Wi-Fi includes:
- Thermostat RT (battery)
- Gateway
- Built-in receiver

Art. KITRT-wifi 199,80€

Additional receiver
(up to 6) radiators)

Art. SA868 64,20€



KIT ELY Wi-Fi TOP DESIGN includes:
- Thermostat with magnetic charging base
and magnetic plate for wall mounting
- Gateway a 230V
- Built-in Receiver

Art. KITELY-wifi 396,10€

Additional receiver: 1 for each electrical radiators
or split AC (up to 16) Art. SA600 99,10€



e.REGULAR

TECHNICAL DATA and other dimensions p. 22
ELECTRIC KIT DATA p. 208-209

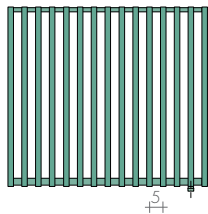

R 75/50-..el
step 50

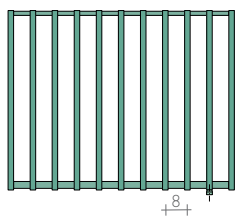

R 75/80-..el
step 80

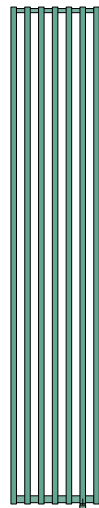
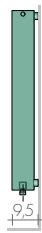

R../50-..el
step 50

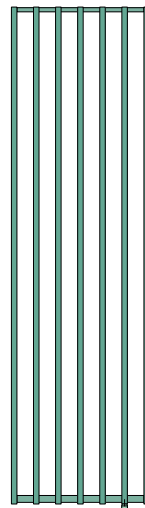

R../80-..el
step 50

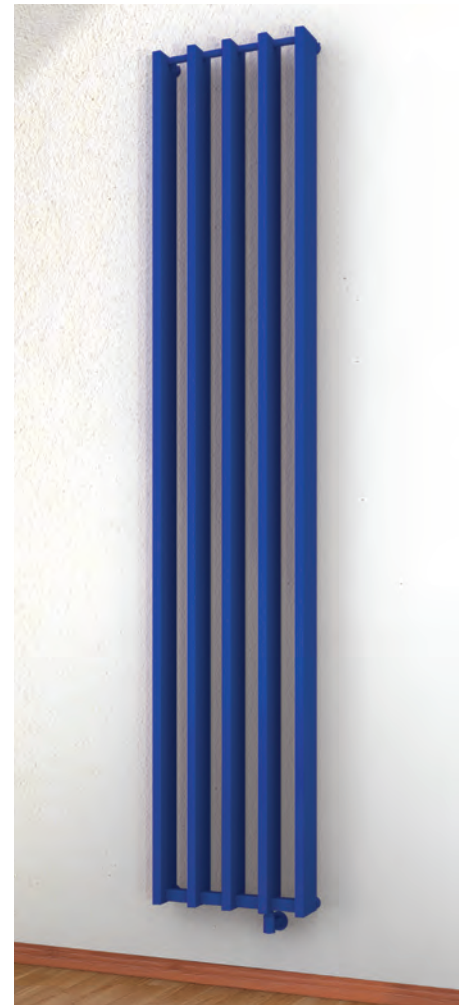

MODEL	Standard white sablé SB 9016		BREM Colors		KIT HEATING ELEMENT with:			
	H/step	n°él.	Lcm	+15% €	+25% €	Cable R.E Art. (W)	Faston R.T Art. (W)	€
R 75/80-9el	66		645,50	742,30	806,90	R650IIE	R650IIT	222,90
R 75/80-11el	82		748,30	860,50	935,40	R800IIE	R800IIT	240,50
R 75/80-13el	98		851,20	978,90	1064,00	R900IIE	R900IIT	255,30
R 75/50-11el	52		748,30	860,50	935,40	R650IIE	R650IIT	222,90
R 75/50-13el	62		851,20	978,90	1064,00	R800IIE	R800IIT	240,50
R 75/50-15el	72		954,00	1097,10	1192,50	R900IIE	R900IIT	255,30
R180/80-5el	34		864,90	994,60	1081,10	R800IIE	R800IIT	240,50
R180/80-7el	50		1070,50	1231,10	1338,10	R1200IIE	R1200IIT	276,30
R200/50-6el	27		1011,40	1163,10	1264,30	R900IIE	R900IIT	255,30
R200/50-8el	37		1225,80	1409,70	1532,30	R1200IIE	R1200IIT	276,30
R200/50-10el	47		1440,10	1656,10	1800,10	R1500IIE	R1500IIT	298,00
R200/80-8el	58		1225,80	1409,70	1532,30	R1500IIE	R1500IIT	298,00

PE = step (distance between the midpoints of 2 elements)

HEATING EL. POSITION
© Vertical Heating Elemen

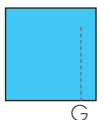

ELECTRIC VERSIONS

THERMOSTATS IN THE RADIATOR FOR KIT RT P. 209

THERMOSTAT mod. DYP



White with
white cable cover
Art. DYPB 89,60€

ø 7 x 9 x 5 cm



Black with
black cable cover
Art. DYPN 103,40€

REMOTE CONTROL for thermostats DYP

10,8 x 5,3 x 2,3 cm



Art. TIR 41,00€

THERMOSTAT CIRCLE Wi-Fi
up to 800 W
heating elements



ø 6 x 8 h x 5 cm



Chrome/Black finish
Art. CIR-wifi 198,50€



e.SBARRA e.SBARRA-UP

TECHNICAL DATA and other dimensions p. 24
ELECTRIC KIT DATA p. 208-209

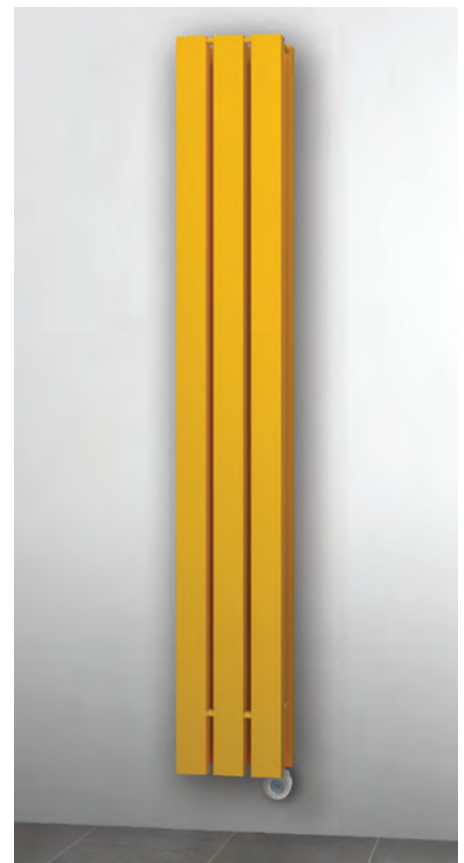
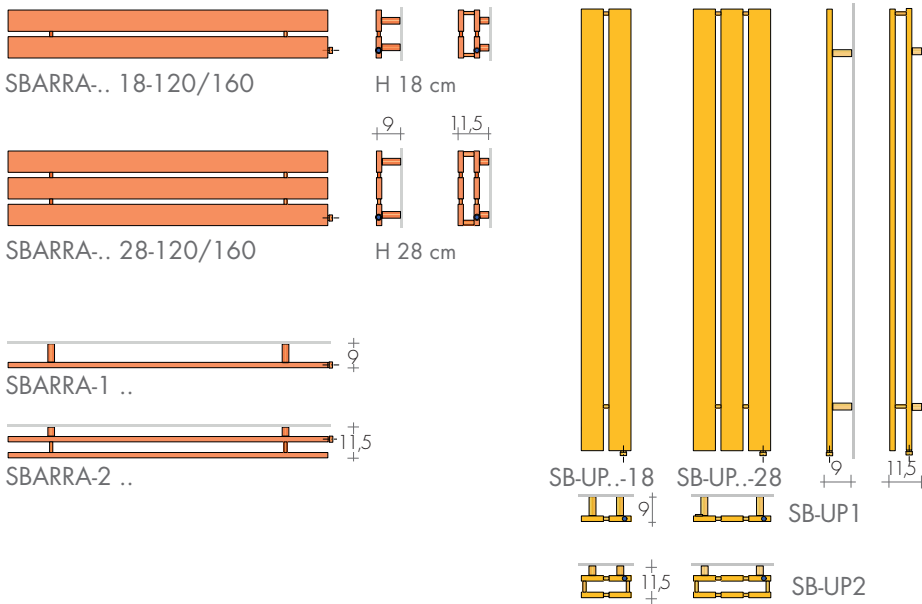

MODEL	H - L cm	Standard white	BREM Colors		KIT HEATING ELEMENT with:		
		sablé SB 9016 €	+15% €	+25% €	Cable R.E Art. (W)	Faston R.T Art. (W)	€
SBARRA-1	18-120	508,30	584,50	635,40	R300IIE	R300IIT	193,80
SBARRA-1	18-160	568,20	653,40	710,30	R400IIE	R400IIT	195,70
SBARRA-1	28-120	615,80	708,20	769,80	R400IIE	R400IIT	195,70
SBARRA-1	28-160	684,40	787,10	855,50	R500IIE	R500IIT	208,50
SBARRA-2	18-120	994,30	1143,40	1242,90	R500IIE	R500IIT	208,50
SBARRA-2	18-160	1094,70	1258,90	1368,40	R650IIE	R650IIT	222,90
SBARRA-2	28-120	1198,50	1378,30	1498,10	R650IIE	R650IIT	222,90
SBARRA-2	28-160	1316,10	1513,50	1645,10	R800IIE	R800IIT	240,50
SB-UP1	180-18	585,20	673,00	731,50	R400IIE	R400IIT	195,70
SB-UP2	180-18	1112,00	1278,80	1390,00	R650IIE	R650IIT	222,90
SB-UP2	180-28	1333,20	1533,20	1666,50	R900IIE	R900IIT	255,30
SB-UP1	220-18	622,40	715,80	778,00	R500IIE	R500IIT	208,50
SB-UP2	220-18	1149,30	1321,70	1436,60	R800IIE	R800IIT	240,50
SB-UP2	220-28	1370,30	1575,80	1712,90	R1200IIE	R1200IIT	276,30

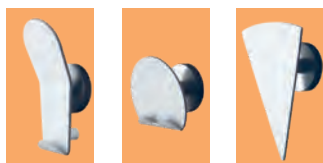

KNOBS with magnet page 277

HEATING EL. POSITION
Ⓚ Horizontal Heating El.
Ⓞ Vertical Heating Element

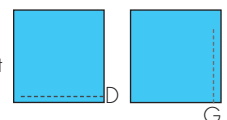

THERMOSTATS Wi-Fi FOR KIT RE P. 208

ACCESSORIES FOR

E.H.E. white cable cover
or radiator color (together)
Art.CCRE38 ø3/8" 73,40€
Art.CCRE12 ø1/2" 73,40€



The KIT RT Wi-Fi includes:
- Thermostat RT (battery)
- Gateway
- Built-in receiver

Art. KITRT-wifi 199,80€

Additional receiver
(up to 6) radiators)



Art. SA868 64,20€

KIT ELY Wi-Fi TOP DESIGN includes:
- Thermostat with magnetic charging base
and magnetic plate for wall mounting
- Gateway a 230V
- Built-in Receiver

Art. KITELY-wifi 396,10€

Additional receiver: 1 for each electrical radiators
or split AC (up to 16) Art. SA600 99,10€



e.SHAR

TECHNICAL DATA and other dimensions p. 196
ELECTRIC KIT DATA p. 208-209

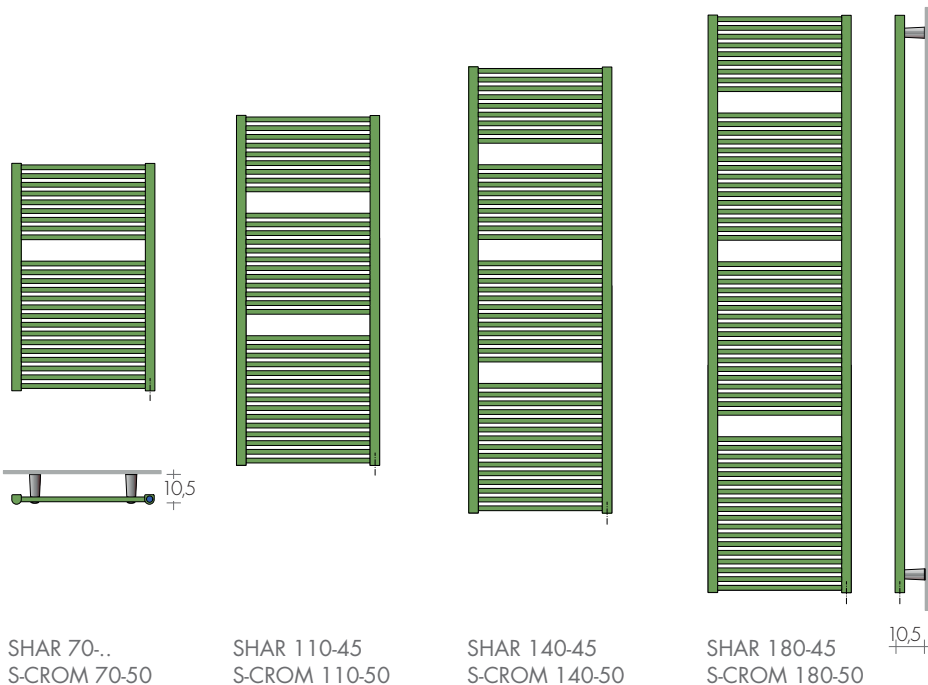

SHAR 70-
S-CROM 70-50

SHAR 110-45
S-CROM 110-50

SHAR 140-45
S-CROM 140-50

SHAR 180-45
S-CROM 180-50

MODEL	H - L cm	Standard white sablé SB 9016 €	BREM Colors		KIT HEATING ELEMENT with:		
			+15% €	+25% €	Cable R.E Art. (W)	Faston R.T Art. (W)	€
SHAR	70-50	410,90	472,50	513,60	R400IIE	R400IIT	195,70
SHAR	70-60	427,10	491,20	533,90	R500IIE	R500IIT	208,50
SHAR	110-45	519,70	597,70	649,60	R500IIE	R500IIT	208,50
SHAR	140-45	653,50	751,50	816,90	R650IIE	R650IIT	222,90
SHAR	180-45	798,80	918,60	998,50	R900IIE	R900IIT	255,30
CHROME-PLATED FINISH							
S-CROM	70-50	896,40	-	-	R300IIE	R300IIT	193,80
S-CROM	110-50	1162,70	-	-	R500IIE	R500IIT	208,50
S-CROM	140-50	1465,40	-	-	R650IIE	R650IIT	222,90
S-CROM	180-50	1789,30	-	-	R800IIE	R800IIT	240,50

CHROME HOOK
(ø 3 x 3,5 cm) p.277 Art. AC n°2 90,90€



HEATING ELEMENT POSITION
© Vertical Heating Element



ELECTRIC VERSIONS

THERMOSTATS IN THE RADIATOR FOR KIT RT P. 209

THERMOSTAT mod. DYP



White with
white cable cover
Art. DYPB 89,60€

ø 7 x 9 x 5 cm



Black with
black cable cover
Art. DYPN 103,40€

REMOTE CONTROL for thermostats DYP

10,8 x 5,3 x 2,3 cm



Art. TIR 41,00€

THERMOSTAT CIRCLE Wi-Fi
up to 800 W
heating elements



ø 6 x 8 h x 5 cm



Chrome/Black finish
Art. CIR-wifi 198,50€



e.SHAR-AIR

TECHNICAL DATA and other dimensions p. 198
ELECTRIC KIT DATA p. 208-209

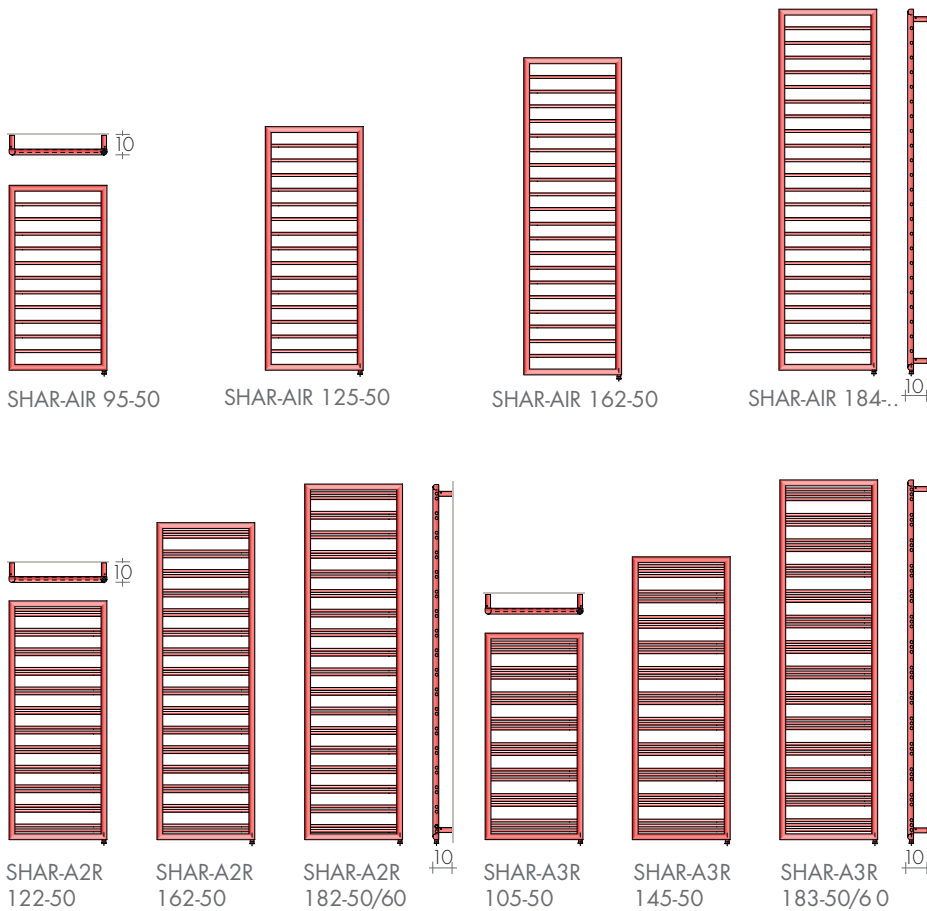

MODEL	H - L cm	Standard white sablé SB 9016 €	BREM Colors		KIT HEATING ELEMENT with:		
			+15% €	+25% €	Cable R..E Art. (WV)	Faston R..T Art. (WV)	€
SHAR-AIR 95-50		536,70	617,20	670,90	R300IIE	R300IIT	193,80
SHAR-AIR 125-50		585,30	673,10	731,60	R400IIE	R400IIT	195,70
SHAR-AIR 162-50		684,90	787,60	856,10	R500IIE	R500IIT	208,50
SHAR-AIR 184-60		750,50	863,10	938,10	R650IIE	R650IIT	222,90
SHAR-A2R 122-50		665,30	765,10	831,60	R500IIE	R500IIT	208,50
SHAR-A2R 162-50		796,70	916,20	995,90	R650IIE	R650IIT	222,90
SHAR-A2R 182-50		853,10	981,10	1066,40	R800IIE	R800IIT	240,50
SHAR-A2R 182-60		905,70	1041,60	1132,10	R900IIE	R900IIT	255,30
SHAR-A3R 105-50		639,90	735,90	799,90	R500IIE	R500IIT	208,50
SHAR-A3R 145-50		786,80	904,80	983,50	R650IIE	R650IIT	222,90
SHAR-A3R 183-50		945,40	1087,20	1181,80	R800IIE	R800IIT	240,50
SHAR-A3R 183-60		1008,60	1159,90	1260,80	R900IIE	R900IIT	255,30

CHROME HOOK only Shar-A2R e A3R
(ø 3 x 3,5 cm) p.277 Art. AC n°2 90,90€



HEATING ELEMENT POSITION
© Vertical Heating Element

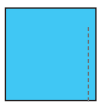

G

THERMOSTATS Wi-Fi FOR KIT RE P. 208

ACCESSORIES FOR

E.H.E. white cable cover
or radiator color (together)
Art.CCRE38 ø3/8" 73,40€
Art.CCRE12 ø1/2" 73,40€



The KIT RT Wi-Fi includes:
- Thermostat RT (battery)
- Gateway
- Built-in receiver

Art. KITRT-wifi 199,80€

Additional receiver
(up to 6) radiators)

Art. SA868 64,20€



KIT ELY Wi-Fi TOP DESIGN includes:
- Thermostat with magnetic charging base
and magnetic plate for wall mounting
- Gateway a 230V
- Built-in Receiver

Art. KITELY-wifi 396,10€

Additional receiver: 1 for each electrical radiators
or split AC (up to 16) Art. SA600 99,10€



e.START e.START CURVO

TECHNICAL DATA and other dimensions p. 200
ELECTRIC KIT DATA p. 208-209

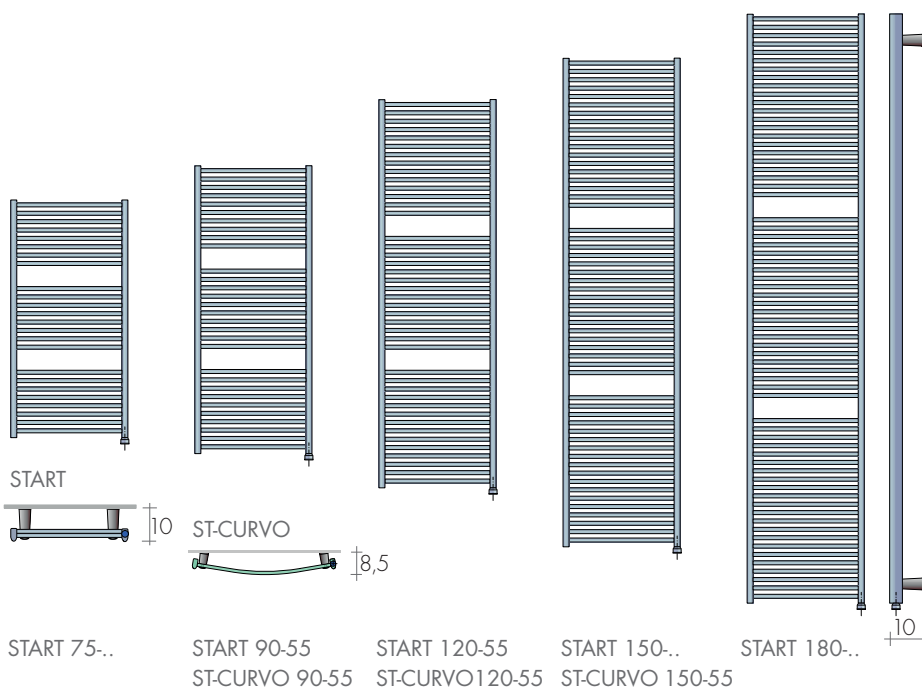

MODEL	H - L cm	Standard white	BREM Colors	BREM Colors	KIT HEATING ELEMENT with:		
		sablé SB 9016 €	+15% €	+25% €	Cable R..E Art. (W)	Faston R..T Art. (W)	€
START	75-45	418,50	481,30	523,10	R300IIE	R300IIT	193,80
START	75-55	438,30	504,00	547,90	R400IIE	R400IIT	195,70
START	90-45	511,80	588,60	639,80	R400IIE	R400IIT	195,70
START	90-55	533,60	613,60	667,00	R500IIE	R500IIT	208,50
START	120-55	634,00	729,10	792,50	R650IIE	R650IIT	222,90
START	150-55	797,10	916,70	996,40	R800IIE	R800IIT	240,50
Slim START	180-35	854,70	982,90	1068,40	R650IIE	R650IIT	222,90
START	180-45	876,50	1008,00	1095,60	R900IIE	R900IIT	255,30
START	180-60	931,30	1071,00	1164,10	R1200IIE	R1200IIT	276,30
ST-CURVO	90-55	732,80	842,70	916,00	R500IIE	R500IIT	208,50
ST-CURVO	120-55	851,30	979,00	1064,10	R650IIE	R650IIT	222,90
ST-CURVO	150-55	1038,70	1194,50	1298,40	R900IIE	R900IIT	255,30

CHROME HOOK
(ø 3 x 3,5 cm) p.277 Art. AC n°2 90,90€



Chromed models 55 cm wide on request
Towel heaters height = H - 4 cm

HEATING ELEMENT POSITION
© Vertical Heating Element

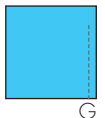

ELECTRIC VERSIONS

THERMOSTATS IN THE RADIATOR FOR KIT RT P. 209

THERMOSTAT mod. DYP



White with
white cable cover
Art. DYPB 89,60€

ø 7 x 9 x 5 cm



Black with
black cable cover
Art. DYPN 103,40€

REMOTE CONTROL for thermostats DYP

10,8 x 5,3 x 2,3 cm



Art. TIR 41,00€

THERMOSTAT CIRCLE Wi-Fi
up to 800 W
heating elements



ø 6 x 8 x 5 cm



Chrome/Black finish
Art. CIR-wifi 198,50€



e.Uni-PLATT

TECHNICAL DATA p. 144
ELECTRIC KIT DATA p. 208-209



MODEL	H - L cm	Standard white	BREM Colors	BREM Colors	KIT HEATING ELEMENT with:		
		sablé SB 9016 €	+15% €	+25% €	Cable R..E Art. (W)	Faston R..T Art. (W)	€
UNI-PLATT	77-50	745,00	856,80	931,30	R400IIE	R400IIT	195,70
UNI-PLATT	126-50	1021,30	1174,50	1276,60	R650IIE	R650IIT	222,90
UNI-PLATT	140-60	1176,70	1353,20	1470,90	R800IIE	R800IIT	240,50

TOWEL BARS UNI: STANDARD COLORS
 - white sablé SB 9016 - quartz grey SB 7039
 - black sablé SB 9005 - same color as the radiator

Chrome towel bar, (each) Extra 88,30€
 Additional chrome towel bar (each) 162,70€

In one paintwork to Brem color list different from the radiator
 Extra Art.CM 52,90€

HEATING ELEMENT POSITION
 © Vertical Heating Element

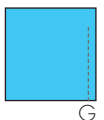

THERMOSTATS Wi-Fi FOR KIT RE P. 208

ACCESSORIES FOR

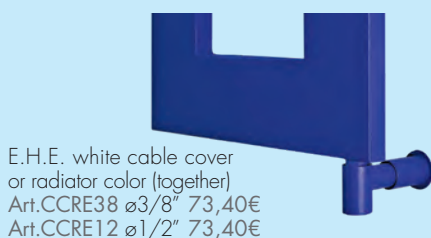

E.H.E. white cable cover
 or radiator color (together)
 Art.CCRE38 ø3/8" 73,40€
 Art.CCRE12 ø1/2" 73,40€

The KIT RT Wi-Fi includes:
 - Thermostat RT (battery)
 - Gateway
 - Built-in receiver

Art. KITRT-wifi 199,80€

Additional receiver
 (up to 6) radiators)



Art. SA868 64,20€

KIT ELY Wi-Fi TOP DESIGN includes:
 - Thermostat with magnetic charging base
 and magnetic plate for wall mounting
 - Gateway a 230V
 - Built-in Receiver

Art. KITELY-wifi 396,10€

Additional receiver: 1 for each electrical radiators
 or split AC (up to 16) Art. SA600 99,10€



e.VELETTA

design Davide Diliberto

TECHNICAL DATA and other dimensions p. 146
ELECTRIC KIT DATA p. 208-209

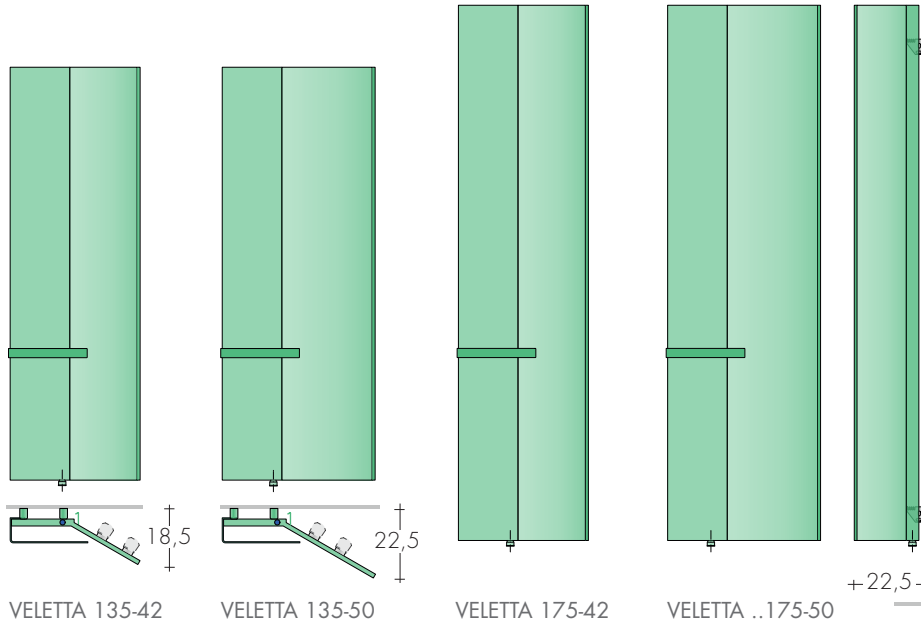

VERSION-SX, on request without extra

MODEL	H - L cm	Standard white sablé SB 9016 €	BREM Colors		KIT HEATING ELEMENT with:		
			+15% €	+25% €	Cable®R..E Art. (W)	Faston^R..T Art. (W)	€
VELETTA	135-42	1145,80	1317,70	1432,30	R650IIE	R650IIT	222,90
VELETTA	135-50	1234,40	1419,60	1543,00	R800IIE	R800IIT	240,50
VELETTA	175-42	1212,80	1394,70	1516,00	R900IIE	R900IIT	255,30
VELETTA	175-50	1307,30	1503,40	1634,10	R900IIE	R900IIT	255,30
VELETTA-L	175-50	1571,60	1807,30	1964,50	R1200IIE	R1200IIT	276,30

TOWEL BAR VEL: STANDARD COLORS
- white sablé SB 9016 - quartz grey SB 7039
- black sablé SB 9005 - same color as the radiator

In one paintwork to Brem color list different from the radiator
Extra Art.CM 52,90€

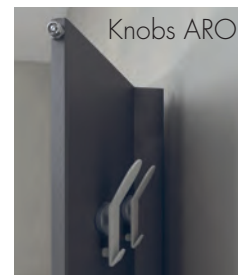
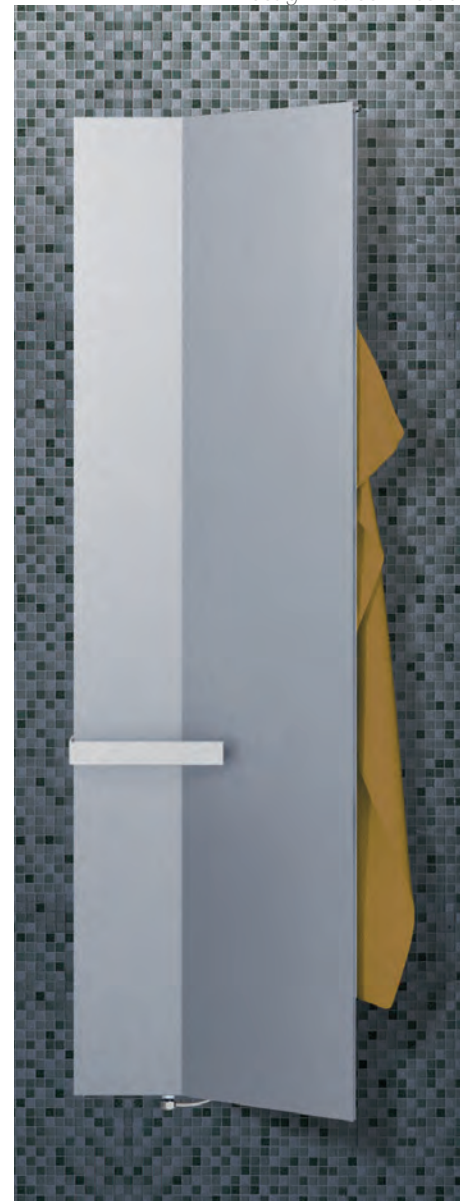

Magnetic KNOBS
NOT INCLUDED
page 277
Art. ARC /POC /HKC
each 95,50€

HEATING ELEMENT POSITION
⊙ Vertical Heating Element

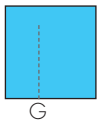

ELECTRIC VERSIONS

THERMOSTATS IN THE RADIATOR FOR KIT RT P. 209

THERMOSTAT mod. DYP



White with
white cable cover
Art. DYPB 89,60€

ø 7 x 9 x 5 cm



Black with
black cable cover
Art. DYPN 103,40€

REMOTE CONTROL for thermostats DYP

10,8 x 5,3 x 2,3 cm



Art. TIR 41,00€

THERMOSTAT CIRCLE Wi-Fi
up to 800 W
heating elements



ø 6 x 8 h x 5 cm



Chrome/Black finish
Art. CIR-wifi 198,50€



e.VISION

design Luigi Brembilla

TECHNICAL DATA and other dimensions p. 82
ELECTRIC KIT DATA p. 208-209

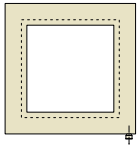

VISION-..48-48
VISION-..56-56
VISION-..64-64

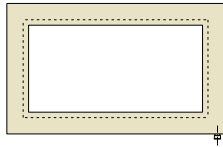

VISION-..48-80

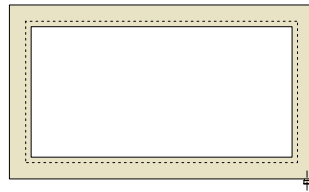

VISION-..64-112

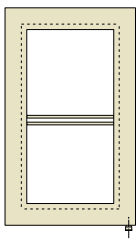

VISION-2ST 80-48

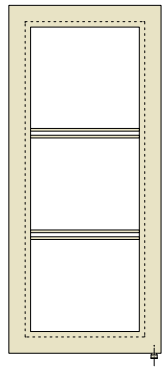

VISION-1ST 128-56

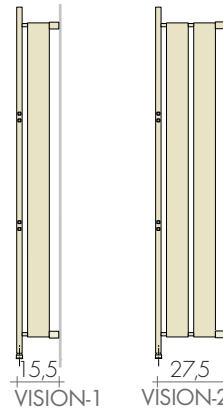

VISION-1

VISION-2



MODEL	H - L cm	Standard white	BREM Colors	BREM Colors	KIT HEATING ELEMENT with:		
		sablé SB 9016 €	+15% €	+25% €	Câble [®] R..E Art. (W)	Faston [^] R..T Art. (W)	€
VISION-1	48-48	717,90	825,60	897,40	R300IIE	R300IIT	193,80
VISION-1	56-56	747,60	859,70	934,50	R400IIE	R400IIT	195,70
VISION-1	64-64	810,70	932,30	1013,40	R500IIE	R500IIT	208,50
VISION-1	48-80	822,50	945,90	1028,10	R500IIE	R500IIT	208,50
VISION-1	56-112	895,20	1029,50	1119,00	R650IIE	R650IIT	222,90
VISION-1	64-112	946,00	1087,90	1182,50	R650IIE	R650IIT	222,90
VISION-2	48-80	1138,90	1309,70	1423,60	R650IIE	R650IIT	222,90
VISION-2	64-112	1310,00	1506,50	1637,50	R900IIE	R900IIT	255,30
VISION-2ST	80-48	1312,20	1509,00	1640,30	R650IIE	R650IIT	222,90
VISION-1ST	128-56	1178,20	1354,90	1472,80	R800IIE	R800IIT	240,50

HEATING ELEMENT POSITION
© Vertical Heating Element

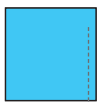

G

THERMOSTATS Wi-Fi FOR KIT RE P. 208

ACCESSORIES FOR

E.H.E. white cable cover
or radiator color (together)
Art.CCRE38 ø3/8" 73,40€
Art.CCRE12 ø1/2" 73,40€



The KIT RT Wi-Fi includes:
- Thermostat RT (battery)
- Gateway
- Built-in receiver

Art. KITRT-wifi 199,80€

Additional receiver
(up to 6) radiators)

Art. SA868 64,20€



KIT ELY Wi-Fi TOP DESIGN includes:
- Thermostat with magnetic charging base
and magnetic plate for wall mounting
- Gateway a 230V
- Built-in Receiver

Art. KITELY-wifi 396,10€

Additional receiver: 1 for each electrical radiators
or split AC (up to 16) Art. SA600 99,10€



ELECTRIC KIT DATA p. 208-209

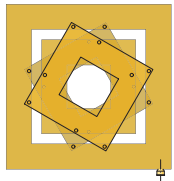
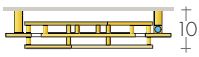

e.ZOOM 50-50

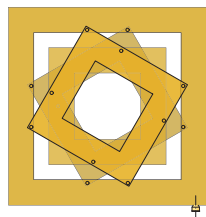

e.ZOOM 60-60

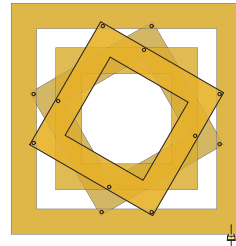

e.ZOOM 70-70

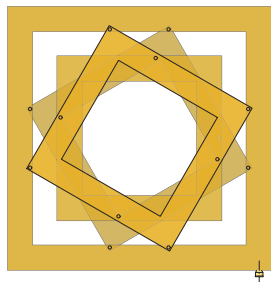

e.ZOOM 80-80

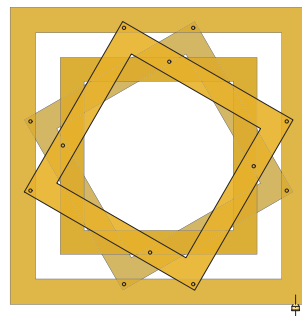

e.ZOOM 90-90

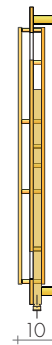

MODEL'25	H - L cm	Standard white	BREM Colors	BREM Colors	KIT HEATING ELEMENT with:		
		sablé SB 9016 €	+15% €	+25% €	Cable R..E Art. (W)	Faston R..T Art. (W)	€
e.ZOOM 50-50		878,50	1010,30	1098,10	R400IIE	R400IIT	195,70
e.ZOOM 60-60		978,00	1124,70	1222,50	R500IIE	R500IIT	208,50
e.ZOOM 70-70		1077,30	1238,90	1346,60	R650IIE	R650IIT	222,90
e.ZOOM 80-80		1214,60	1396,80	1518,30	R650IIE	R650IIT	222,90
e.ZOOM 90-90		1379,40	1586,30	1724,30	R800IIE	R800IIT	240,50

Prices include the additional manifold

ON REQUEST HYDRAULIC VERSION

MODEL'25	H-L cm	Standard white sablé SB 9016 €	EN 442 Δt 50 K watt	Δt 40 K watt	Δt 30 K watt	▲ ▽ t.c. cm	Depth cm	Weight M Kg	Volume V dm ³
ZOOM 50-50		774,00	358	270	188	19	11,5	7,4	2,2
ZOOM 60-60		873,50	463	350	244	19	11,5	9,0	2,7
ZOOM 70-70		972,80	577	436	304	19	11,5	12,1	3,6
ZOOM 80-80		1110,10	681	514	358	19	11,5	14,3	4,3
ZOOM 90-90		1274,90	804	607	423	19	11,5	16,8	5,0

Mixed Version to estimate

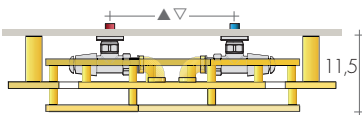

REVERSE FITTINGS
REG \varnothing 1/2" ▲ ▽ 19 cm at the rear



HEATING ELEMENT POSITION
© Vertical Heating Element

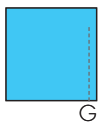

ELECTRIC VERSIONS

THERMOSTATS IN THE RADIATOR FOR KIT RT P. 209

THERMOSTAT mod. DYP



White with
white cable cover
Art. DYPB 89,60€

\varnothing 7 x 9 x 5 cm



Black with
black cable cover
Art. DYPN 103,40€

REMOTE CONTROL for thermostats DYP

10,8 x 5,3 x 2,3 cm



Art. TIR 41,00€

THERMOSTAT CIRCLE Wi-Fi up to 800 W heating elements



\varnothing 6 x 8 x 5 cm



Chrome/Black finish
Art. CIR-wifi 198,50€



VALVES & ACCESSORIES



VALVES 266

TON VALVES 268

TON VALVES KIT 269

MINI VALVES 270

QUADRA VALVES 271

CYL VALVES 272

CYL VALVES KIT 273

DISTANT VALVES 274

SISTEM WiFi 275

SPECIAL VERSIONS 276

BRACKETS 276

ACCESSORIES 277

FITTINGS 278



CHROME-PLATED VALVES

BREM proposes the substitution of the traditional valves with one type of valve, which can also be used as lock-shield.

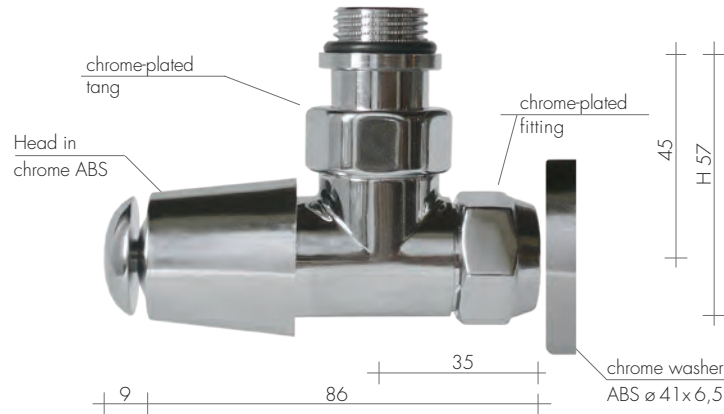

- Brem valves are complete with:
- chrome-plated o-ring tang ($\varnothing 3/8'' - 1/2''$)
 - chrome-plated fitting with o-ring
 - chrome-plated round washer ($\varnothing 41 \times 6,5 \text{ mm}$)
 - thermostatic head (for thermostatic valves)

On demand: stainless steel pipe cover to be cut to right size

VALVES COMPONENTS

CHROME-PLATED O-RING TANG

$\varnothing 3/8'' - 1/2''$

to connect to the radiator

1/2" Fitting

Art. CVL12 10,00€

3/8" Fitting

Art. CVL38 10,00€



CHROME-PLATED FITTINGS (24F19)

to connect to the system:



Multilayer FITTINGS $\varnothing 10-14, 12-16, 13-18, 14-18, 16-20$

Art. RM.. 9,20€



Copper FITTINGS $\varnothing 10-12-14-15-16-18$

Art. RR..(R10 - R12 - R..) 6,80€

VALVE FITTING KIT et INSERTS

Chromed fittings and washers for 2 valve (tube multi-couche $\varnothing 16$ and cuivre $\varnothing 12-14$) Art. RK 38,20



Round washer chrome-plated



Fitting with inserts for multilayer $\varnothing 16$



Inserts for copper $\varnothing 12$ and $\varnothing 14$

FITTINGS KIT FOR PAIR of COLORED VALVES

n.2 cones

n.2 fittings

n.2 washers



- BRUSHED NICKEL Finish

Supplement Art. RN 30,50€

- BRONZE Finish

Supplement Art. RB 28,50€

- OR Finish

Supplement Art. RO 57,00€



VALVES ACCESSORIES

ROUND WASHER chrome-plated $\varnothing 41 \text{ mm}$
for tubes $\varnothing 10 - 12 - 14 - 15 - 16 - 18 - 1/2''$
(indicate \varnothing) Art. RC.. 3,40€



CHROME-PLATED ECCENTRICS

Adaptors to be mounted between valve and radiator to vary tapping centre from 1 to 6 cm

Art. EC1 1 cm eccentric 14,30€

Art. EC2 2 cm eccentric 19,40€

Art. EC3 3 cm eccentric 22,50€

Specify when ordering if 1/2" or 3/8"



TUBES COVERS for fittings

10 cm long, polished stainless steel tube: slide over pipes for fitting $\varnothing \leq 16 \text{ mm}$ and cut in half to size using the round washer to cover the cut.

inner $\varnothing 15 \text{ mm}$

Art. CA15 11,10€

inner $\varnothing 16 \text{ mm}$

Art. CA16 11,10€

for valves KIT

Art. CA18 12,40€



SINGLE TUBE COVERING KIT

tapping centres 38mm, 5x10cm squared covering, and n° 2 tubes $\varnothing 16$ or $\varnothing 20 \text{ L}=7 \text{ cm}$

Art. KM16 65,70€

Art. KM20 68,60€



THERMOSTATIC CHROME-PLATED HEAD

Thermostatic head with liquid sensor (only for valves with thermostatic option)

Art. STC 53,10€



THERMOSTATIC CHROME-PLATED HEAD

Metal thermostatic head with liquid sensor (only for valves with thermostatic option)

- WHITE and MATT BLACK

Art. STB/STN cad. 61,20€

- BRUSHED NICKEL Finish

Art. STN cad. 78,70€

- BRONZE Finish

Art. STR cad. 76,00€

- GOLD Finish

Art. STO cad. 89,60€

SPECIAL FINISHES

VALVES - ACCESSORIES

TON
VALVE



GILDED LEAF FINISH

TON and QUADRA valve in gilded leaf.
O-ring tang \varnothing 1/2" or 3/8", multilayer fitting \varnothing 16,
copper \varnothing 12,14 (other diameters by estimate) and
round washer, all in gold finish

Extra each Art. VFO 95,20€

QUADRA
VALVE



SILVER LEAF FINISH

TON and QUADRA valve in silver leaf.
O-ring tang \varnothing 1/2" or 3/8", multilayer fitting \varnothing 16,
copper \varnothing 12,14 (other diameters by estimate) and
round washer, all in brushed nickel finish

Extra each Art. VFA 95,20€



GOLDEN FINISH

TON and QUADRA valve, oring tang \varnothing 1/2" or
3/8", fitting (multilayer \varnothing 16, copper \varnothing 12,14),
golden finish round washer (variable price)

Extra each Art. VOR 76,40€



BRONZE FINISH

TON and QUADRA valve, oring tang \varnothing 1/2" or
3/8" and fitting (multilayer \varnothing 16, copper \varnothing 12,14),
in bronze finish and round washer in bronze color

Extra each Art. VBZ 34,10€



BRUSHED NICKEL FINISH

TON and QUADRA valve, oring tang \varnothing 1/2" or
3/8", fitting (multilayer \varnothing 16, copper \varnothing 12,14) and
round washer, all in brushed nickel finish

Extra each Art. VNS 36,00€



On request:
CYL VALVES IN SPECIAL FINISHES

CHROME-PLATED TON VALVE

Easy control valve also usable as a lockshield with tang, fitting and round washer

Valve with chrome thermostatic head, tang, fitting and round washer

ANGLED TON VALVE



Art. VSM.. 59,20€
Art. VSR.. 56,90€
Art. VSF 54,90€



THERMOSTATIC ANGLED TON VALVE



Art. TSM.. 112,40€
Art. TSR.. 110,10€
Art. TSF 107,00€

STRAIGHT TON VALVE



Art. VDM.. 65,30€
Art. VDR.. 63,00€
Art. VDF 60,60€

TON VALVE
Headwheel \varnothing 28-34 / L 95 / H 57mm

THERMOSTATIC STRAIGHT TON VALVE



Art. TDM.. 118,50€
Art. TDR.. 116,20€
Art. TDF 111,80€

VALVES LEGEND:

VS.. Angled TON	FITTINGS for tubes:
VD.. Straight TON	M Multilayer
VR.. Reverse TON	R Copper
L.. Side control TON	F Steel \varnothing 1/2"
T.. Thermostatic valve	INDICATE \varnothing OF TUBE

REVERSE TON VALVE



Art. VRM.. 59,20€
Art. VRR.. 56,90€
Art. VRF 54,90€

Angled TON Valve Copper fitting
How to order: ART. VSR14—tube \varnothing 14

THERMOSTATIC REVERSE TON VALVE



Art. TRM.. 112,40€
Art. TRR.. 110,10€
Art. TRF 107,00€

SIDE CONTROL TON VALVE

Indicate always S or D version



Art. L..M.. 65,90€
Art. L..R.. 63,60€
Art. L..F 60,70€

THERMOSTATIC SIDE CONTROL left TON VALVE.



Art. LTSM.. 119,10€
Art. LTSR.. 116,70€
Art. LTDF 113,90€

MIXED TON VALVE only \varnothing 1/2" Electric Heating El.



Art. LXDM.. 103,70€
Art. LXDR.. 101,30€

TUBES COVERS for fittings
10 cm long, polished stainless steel tube: slide over pipes for fitting $\varnothing \leq 16$ mm and cut in half to size using the rose washer to cover the cut
inner \varnothing 15 mm Art. CA15 11,70€
inner \varnothing 16 mm Art. CA16 11,70€

THERMOSTATIC SIDE CONTROL left TON VALVE



Art. LTDM.. 119,10€
Art. LTDR.. 116,70€
Art. LTDF 113,90€

NICKEL-PLATED TON VALVES KIT

SIDE CONTROL TON VALVES KIT, easy control, nickel-plated valves, chrome round washer.



Art. KVLN 104,80€

The KIT includes 2 easy control valves or a thermostatic valve and a easy control valve, unions, round washer \varnothing 48 and fittings for multilayer pipe \varnothing 16 and copper pipe inserts \varnothing 12 and \varnothing 14

SIDE CONTROL TON VALVES KIT with THERMOSTATIC Head, nickel-plated valves, chrome round washer.



Art. KTLND 161,10€

CHROME-PLATED TON VALVES KIT

TON valves KIT

The KIT includes 2 simple regulation valves with tangs, round washers $\varnothing 48$ and fittings for multilayer pipe $\varnothing 16$ and 4 copper pipe inserts $\varnothing 12$ and 14



Fitting with inserts for multilayer $\varnothing 16$



inserts for copper $\varnothing 14$



inserts for copper $\varnothing 12$

TON KIT Thermostatic head

The KIT includes a thermostatic valve and a simple regulation valves, with tangs, round washers $\varnothing 48$ and fitting with n°6 inserts for pipe multilayer $\varnothing 16$, copper $\varnothing 12 - \varnothing 14$



ANGLED TON VALVES KIT
Art. KVS 137,10€

ANGLED TON VALVES KIT with THERMOSTATIC Head Art. KTS 190,30€



STRAIGHT TON VALVES KIT
Art. KVD 149,30€

STRAIGHT TON VALVES KIT with THERMOSTATIC Head Art. KTD 202,40€



REVERSE TON VALVES KIT
Art. KVR 137,10€

REVERSE TON VALVES KIT with THERMOSTATIC Head Art. KTR 190,30€



SIDE CONTROL TON VALVES KIT
Art. KVL 150,50€

SIDE CONTROL TON VALVES KIT with THERMOSTATIC Head
S version Art. KTL 203,70€
D version Art. KTLD 203,70€



TUBES COVERS for KIT

10 cm long, polished stainless steel tube: slide over pipes for fitting $\varnothing \leq 16$ mm and cut in half to size using the rose washer to cover the cut for VALVES KIT



Art. CA18 12,40€

TON VALVES KIT for DUAL FUEL VERSIONS



Art. KLXD

SIDE CONTROL TON VALVES KIT S and MIXED VALVE with $\varnothing 1/2"$ for Electric Heating Element
Art. KLXD 188,20€

SIDE CONTROL TON VALVES KIT with Thermostatic Head and MIXED
Art. KTLXD 241,50€



Art. KTLXD

CHROME-PLATED MINI VALVE

MINI Model

Easy control valve also usable as a lockshield with tang, fitting and round washer

ANGLED MINI VALVE



Art. MSM.. 52,70€
Art. MSR.. 50,30€

STRAIGHT MINI VALVE



Art. MDM.. 59,10€
Art. MDR.. 56,80€



MINI VALVE

Headwheel ø 24 / 71,5 / H 57mm

MINI valve: harmonious combination of essential design, very small size and easy control.

MS.. Angled Mini
MD.. Straight Mini

FITTINGS for Tubes:
M Multilayer
R Copper

INDICATE TUBE Ø

How to order: ART. MS $\frac{\text{Angled MINI valve}}{\text{Multilayer fitting}}$ M12-16 $\frac{\text{Copper}}{\text{Multilayer fitting}}$ ø12-16 tube

MINI valves KIT

The KIT includes 2 simple regulation valves with tangs, round washers ø 48 and fittings for multilayer pipe ø16 and 4 copper pipe inserts ø12 and 14



ANGLED MINI VALVES KIT



Art. KMS 124,00€

STRAIGHT MINI VALVES KIT



Art. KMD 136,90€

TUBES COVERS for fittings



Ø 18mm, 10 cm long, polished stainless steel tube: slide over pipes for fitting (ø 12, 14, 16 mm) and cut in half to size using the rose washer with adapters to cover the cut.

inner ø15 mm
inner ø16 mm
for valves KIT

Art. CA15 11,10€
Art. CA16 11,10€
Art. CA18 12,40€

WHITE MINI VALVE

Angled WHITE MINI

ANGLED WHITE MINI VALVE

Valve usable also as lock-shield, complete with chrome-plated O-ring Tang, fitting and round washer.

Art. MSBM.. 52,70€ Ral 9016
Art. MSBR.. 50,30€ Ral 9016



ANGLED WHITE MINI VALVE

MINI valve is provided in standard white (chr.-plated O-ring Tang, fitting and round washer)

Angled WHITE MINI valves KIT



ANGLED WHITE MINI VALVES KIT

n°2 Standard white MINI valves complete with chrome-plated O-ring Tangs, round washers and fittings (multilayer ø16, copper ø12, 14)

Art. KMSB 124,00€ Ral 9016

KIT Fitting brushed NICKEL for n°2 valves

extra Art. RN 30,50€



CHROME-PLATED QUADRA VALVE

QUADRA Model

Easy control valve also usable as a lockshield with tang, fitting and round washer



QUADRA VALVE

Headwheel 26x26 / 86 / H 57mm

QUADRA Valves KIT

The KIT includes 2 simple regulation valves with tangs, round washers ø 48 and fittings for multilayer pipe ø16 and 4 copper pipe inserts ø12 and 14



ANGLED QUADRA VALVES KIT



Art. KQS 180,10€

STRAIGHT QUADRA VALVES KIT



Art. KQD 190,00€

REVERSE QUADRA VALVES KIT



Art. KQR 180,10€

SIDE control QUADRA VALVES KIT



Art. KQL 191,20€

ANGLED QUADRA VALVE



Art. QSM.. 80,70€
Art. QSR.. 78,30€

STRAIGHT QUADRA VALVE



Art. QDM.. 85,70€
Art. QDR.. 83,40€

REVERSE QUADRA VALVE

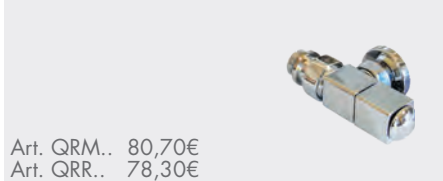

Art. QRM.. 80,70€
Art. QRR.. 78,30€

SIDE control QUADRA VALVE
Always state S or D version.



Art. QL..M.. 86,40€
Art. QL..R.. 84,00€

QUADRA valve: refined geometrical design to match with other squared shapes.

QS.. QUADRA Angled FITTINGS for tubes
QD.. QUADRA Straight M Multilayer
QR.. QUADRA Reverse R Copper
QL.. QUADRA Side control INDICATE tube ø

Reverse QUADRA valve Copper fitting
How to order: ART. QR R14 tube ø14

MIXED QUADRA VALVE only ø1/2" for Electric Heating Element. Easy control valve. It can be used together with angled or side control valves. Indicate always S or D version



Art. QLX..M.. 121,00€
Art. QLX..R.. 118,60€

COLORED QUADRA VALVE

COLORED QUADRA Model

COLORED QUADRA VALVE

Valves in the same BREM color of radiator, complete with chrome-plated O-ring Tang, fitting and round washer (with inserts for multilayer ø16 and copper ø12,14).

EXTRA FOR COLOR n. 2 pieces Art. VC 53,40€



QUADRA COLORED VALVE

ANGLED - STRAIGHT - REVERSE - SIDE CONTROL provided in one color of BREM list (chrome-plated O-ring Tangs, fittings and washer)

COLORED QUADRA Valves KIT

COLORED QUADRA VALVES KIT

- n°2 QUADRA valves in the same BREM color of radiator, complete with chrome-plated O-ring Tangs, fittings and round washers (with inserts for multilayer ø16 and copper ø12 and ø14).

EXTRA FOR COLOR (KIT) Art. VC 53,40€
KIT Fitting brushed NICKEL extra Art. RN 30,50€



KIT Fitting brushed NICKEL for n°2 valves extra Art. RN 30,50€



CHROME-PLATED CYL VALVE WITH THERMOSTATIC OPTION

Valve convertible to thermostatic for manual or electronic thermostatic heads.
Valve and lockshield can be painted in a color from the BREM color.
O-ring tang, fittings and round washer only chrome-plated.



VALVES LEGEND:
CS.. Angled CYL
CD.. Straight CYL
CR.. Reverse CYL
CL.. Side control CYL

LOCKSHIELD LEGEND:
CYS.. Angled lockshield CYL
CYD.. Straight lockshield CYL
CYR.. Reverse lockshield CYL
CYL.. Side control lockshield CYL

FITTINGS for tubes:
M Multilayer
R Copper
Indicate ø of tube.
Angled CYL Valve Copper fitting
How to order: ART. CSR14 tube ø14

VALVE CYL
Headwell ø 31 / 88 / H 57mm
LOCKSHIELD CYL
Cap ø 26 / 72 / H 57mm

Valve and lockshield complete with O-ring tang, fittings and round washer only chrome-plated.

ANGLED CYL VALVE
THERMOSTATIC option



Art. CSM.. 78,90€
Art. CSR.. 76,60€

ANGLED CYL LOCKSHIELD.



Art. CYSM.. 52,40€
Art. CYSR.. 50,00€

THERMOSTATIC ANGLED CYL VALVE



Art. TSM.. 112,40€
Art. TSR.. 110,10€

STRAIGHT CYL VALVE
THERMOSTATIC option



Art. CDM.. 83,30€
Art. CDR.. 80,90€

STRAIGHT CYL LOCKSHIELD



Art. CYDM.. 56,90€
Art. CYDR.. 54,50€

THERMOSTATIC STRAIGHT CYL VALVE



Art. TDM.. 118,50€
Art. TDR.. 116,10€

REVERSE CYL VALVE THERMOSTATIC option



Art. CRM.. 78,90€
Art. CRR.. 76,60€

REVERSE CYL LOCKSHIELD



Art. CYRM.. 56,90€
Art. CYRR.. 54,50€

THERMOSTATIC REVERSE CYL VALVE



Art. TRM.. 112,40€
Art. TRR.. 110,10€

SIDE CONTROL CYL VALVE THERMOSTATIC option. Indicate always S or D version.



Art. CL..M.. 85,30€
Art. CL..R.. 82,90€

SIDE CONTROL CYL LOCKSHIELD
Indicate always S or D version.

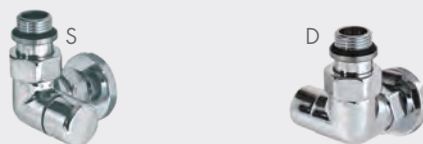

Art. CYL..M.. 58,60€
Art. CYL..R.. 56,30€

THERMOSTATIC SIDE CONTROL CYL VALVE
Indicate always S or D version.



Art. LT..M.. 119,10€
Art. LT..R.. 116,70€

TUBES COVERS for fittings



Ø 18mm, 10 cm long, polished stainless steel tube: slide over pipes for fitting (ø 12, 14, 16 mm) and cut in half to size using the rose washer with adapters to cover the cut.

inner ø15 mm Art. CA15 11,10€
inner ø16 mm Art. CA16 11,10€
for valves KIT Art. CA18 12,40€

MIXED CYL LOCKSHIELD for ø1/2" Electric Heating El. Easy control valve complete with fitting and round washer, it can be used together with angled or side control valves. Indicate always S or D version.

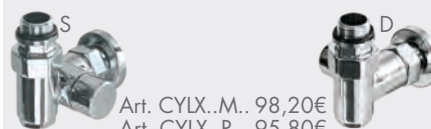

Art. CYLX..M.. 98,20€
Art. CYLX..R.. 95,80€

SINGLE TUBE COVERING KIT tapping centres 38mm 100x50mm squared covering, and n° 2 tubes (16 or 20mm ø, 70mm long).

Art. KM16 68,90€
Art. KM20 72,00€



CYL VALVE KIT in BREM COLOURS



CYL painted, fittings and round washer chrome-plated
Extra for BREM color list + KIT Fitting brushed NICKEL

The valves with thermostatic option and the CYL lockshields can be supplied painted in a colour from the BREM colour list, (O-ring tang, fittings and round washer chrome-plated). Valve or Dual tube CYL KIT: Extra for BREM color list Art. VC 53,40€



KIT Fitting brushed NICKEL for n°2 valves
extra Art. RN 30,50€

CHROME-PLATED CYL VALVE KIT

CYL KIT with THERMOSTATIC OPTION

Chrome Valve CYL with thermostatic option and lockshield with tang, washer $\varnothing 48$ and fitting with n°6 inserts for pipe multilayer $\varnothing 16$, copper $\varnothing 12 - \varnothing 14$



Fitting with inserts for multilayer $\varnothing 16$



inserts for copper $\varnothing 14$



inserts for copper $\varnothing 12$

CYL KIT with THERMOSTATIC HEAD

Chrome Valves CYL KIT with thermostatic head, with tang, washer $\varnothing 48$ and fitting with n°6 inserts for pipe multilayer $\varnothing 16$, copper $\varnothing 12 - \varnothing 14$



ANGLED CYL VALVES KIT THERMOSTATIC option Art. KCS 149,90€

ANGLED CYL VALVE KIT with THERMOSTATIC Head Art. KCTS 179,90€



STRAIGHT CYL VALVES KIT THERMOSTATIC option Art. KCD..158,80€

STRAIGHT CYL VALVES KIT with THERMOSTATIC Head Art. KCTD 188,80€



REVERSE CYL VALVES KIT THERMOSTATIC option Art. KCR 149,90€

REVERSE CYL VALVES KIT with THERMOSTATIC Head Art. KCTR 179,90€



Art. KCL

SIDE CONTROL CYL VALVES KIT THERMOSTATIC option Art. KCL 162,50€
Version D Art. KCLD 162,50€

SIDE CONTROL CYL VALVES KIT with THERMOSTATIC Head Art. KCTL 192,60€
Version D Art. KCTLD 192,60€



Art. KCLD



Art. KCTL

Art. KCTLD



SINGLE-TUBE CYL VALVE KIT THERMOSTATIC option $\blacktriangle \nabla$ 38mm with $\varnothing 10$ mm and 45 cm probe, and flow diverter system to everse delivery and return.
Art. KCM 175,90€

probe cm 70 10,10€
probe cm 100 14,10€

SINGLE TUBE Valve KIT with THERMOSTATIC Head $\blacktriangle \nabla$ 38mm Art. KTM 206,00€



DUAL TUBE CYL Valve KIT THERMOSTATIC option, $\blacktriangle \nabla$ 5 cm Art. KCB 171,50€

DUAL TUBE Valve KIT with THERMOSTATIC Head, $\blacktriangle \nabla$ 5 cm Art. KTB 201,50€



CYL VALVE KIT FOR DUAL FUEL VERSIONS



Art. KCLXD

SIDE CONTROL CYL VALVES KIT THERMOSTATIC option, lockshield Mixte Art. KCLXS 202,10€
D Version Art. KCLXD 202,10€

SIDE CONTROL CYL VALVES KIT THERMOSTATIC lockshield Mixte Art. KCTLXS 232,10€
D Version Art. KCTLXD 232,10€



Art. KCLXS

REMOTE VALVES

REMOTE VALVES GROUP

The remote valves group includes 2 builtin valves in raw brass to be fixed on the wall bracket, with chromed handwheels, washers and chrome fittings for: MULTILAYER or COPPER pipe (indicate \varnothing of tube)



TON REMOTE Valves GROUP wall recessed with 2 valves, round washers and fittings (provide \varnothing of tube):
 MULTILAYER Art. VGM.. 158,00€
 COPPER Art. VGR.. 155,60€

TON REMOTE Valves GROUP with THERMOSTATIC HEAD and complete fittings (provide \varnothing of tube):
 MULTILAYER Art. VGTM.. 211,10€
 COPPER Art. VGTR.. 208,70€



CYL REMOTE Valves GROUP wall recessed with THERMOSTATIC OPTION with 2 valves, round washers and fittings (provide \varnothing of tube):
 MULTILAYER Art. CGM..205,70€
 COPPER Art. CGR.. 201,00€

CYL REMOTE Valves GROUP with THERMOSTATIC HEAD and complete fittings (provide \varnothing of tube):
 MULTILAYER Art. CGTM..222,70€
 COPPER Art. CGTR.. 217,90€



QUADRA REMOTE Valves GROUP wall recessed with 2 valves, round washers and fittings (provide \varnothing of tube):
 MULTILAYER Art. QGM..174,20€
 COPPER Art. QGR.. 171,20€
 Extra for BREM color list Art. VC 53,40€

Remote valves are placed in a low-visibility spot. In case of thermostatic valves, they should be sensitive to room temperature.



KIT REMOTE VALVES GROUP

The Kit includes 2 raw brass valves to be fixed on the wall bracket, chromed round handwheels, washer and fittings with inserts for multilayer pipes \varnothing 16 and copper \varnothing 12 and 14 mm.



Thermostatic TON valves

TON VALVE GROUP KIT with simple regulation
 Art. KVG 176,60€

TON VALVE GROUP KIT with thermostatic head
 Art. KVGT 229,80€



CYL remote valves

CYL Valves GROUP KIT thermostatic option
 Art. KCG 224,30€

CYL Valves GROUP KIT with thermostatic head
 Art. KCGT 241,30€

Extra for BREM color list Art. VC 53,40€



QUADRA remote valves

QUADRA Valves GROUP KIT with simple regulation
 Art. KQG 192,90€

Extra for BREM color list Art. VC 53,40€

FITTINGS AT THE REAR OF RADIATOR

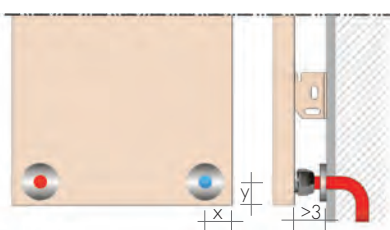

Brem proposes fittings consisting of threaded sleeves (\varnothing 24 F19) welded on the back of the radiator.
 Art. REM 42,10€

The connection of the pipes from the remote group (up to 6 m.), is made by screwing the \varnothing 16 or \varnothing 12-14 fittings complete with washers, directly to the radiator.
 Art. RK 38,20€

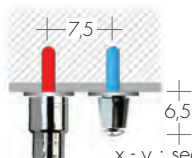
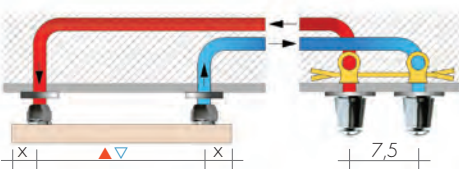

x - y : see dimensions in each model



ADVANCED wifi SYSTEM

THERMOSTATS COMPLIANT WITH ECODESIGN STANDARDS

No matter where you are, your home can always be within reach. You can control

your devices with our free application. With a few simple clicks you can adjust all the

parameters of your living space to meet the needs of you and your family.

GATEWAY WiFi

The GTAD Advanced Gateway allows you to control various devices: thermostats, valves, air conditioning, household appliances.

- LED Indication
- Connects all SALUS Smart Home products to the Salus Smart Home app - Salus Premium Lite app
- Cable and WiFi connection (cable connection is needed to set up WiFi)
- Table or wall mounted
- Wireless ZigBee communication
- 5 Year Warranty

GATEWAY

Art. GT-AD 245,50€

Gateway
ø 9 x 5,5 cm



V-SMART

The thermostatic head V-SMART offers quiet operation, advanced features and Zigbee 3.0 connectivity, ideal for efficient home heating management.

- Operates standalone or pairs with a room thermostat.
- Intuitive interface with a dial knob and LCD display.
- Supports 4 display orientations for flexible radiator installations.
- Interchangeable adapters (M30, M28, RA).

THERMOSTAT WiFi

wired from SEMI-RECESSED

Art. TWIB 206,70€



8,6 x 8,6 x 2,8 cm

- ZigBee protocol
- 230V power supply
- Large LCD screen
- Humidity sensor
- Thickness outside the wall 1 cm
- Programmable - daily, weekly or 5/2
- Hysteresis ± 0.5 and 0.25
- Dry contact or 230V contact outputs
- ITLC (compensazione del carico della temperatura)
- 2 contacts for presence sensor (external/floor sensor)
- Internal relay - Breaking capacity: 3 (1) A
- Control from the Salus Smart Home app
- Heating / Cooling mode
- Class IV ERP
- Works with the GTAD gateway or independently

For heating centralized installations with autonomous management

CENTRAL HEATING



Art. V-SMART 106,20€

ø 5,3 x 9,2 cm

Thermostatic head for radiators

INDEPENDENT HYDRAULIC HEATING



Art. TWIB 206,70€

Thermostat da incasso



Art. V-SMART 106,20€

Thermostatic head for radiators

CENTRAL HEATING AND ELECTRIC RADIATORS



Art. V-SMART 106,20€

ø 5,3 x 9,2 cm

Thermostatic head for radiators

ELY ADVANCE

Art. ELY-AD 212,10€

Thermostat up to 16 receivers



Art. SA600 99,10€

Built-in receiver for electric radiators/split/ accessories (1 pc for each device)

4,5 x 4,5 x 2 cm



INDEPENDENT HYDRAULIC HEATING AND ELECTRIC RADIATORS



Art. TWIB 206,70€

Thermostat da incasso



Art. V-SMART 106,20€

Thermostatic head for radiators

ELY ADVANCE

Art. ELY-AD 212,10€

Thermostat up to 16 receivers



Art. SA600 99,10€

Advanced receiver

OPTIONAL

Additional receiver for electric radiators and split AC: 1 for each electrical device (up to 16)

Art. SA600 99,10€



8,4x8,4x2,8 cm

On Wall Box for relay Art. SUNI 19,90€

COMPATIBLE with: alexa



8,5 x 8,5

Thermostat ELY DESIGN ADVANCE
Thermostat with charging base and fixing plate: communicates only with electrical devices up to 16 units

SPECIAL VERSIONS - BRACKETS

"IN CORNER" RADIATORS

On request, the EGON, FORM and GRATA radiators can be supplied made-to-measure in corner configuration to ensure adequate heating in rooms where the conformation of walls, doors, and windows precludes more traditional positions for the radiators.

The most popular solutions are :

- with internal angle
- with external angle
- with two external angles

Send a detailed drawing for a feasibility study and quotation.

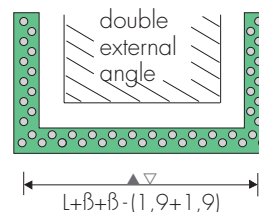
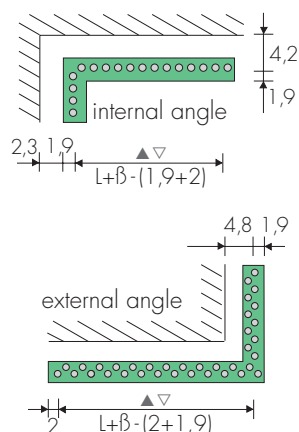

Radiators in corner:

(β) dimension (mm) + standard radiator:	Mod.	F2H	GRH	EH
internal angle	β	25	30	20
external angle	β	20	30	25

FORM - GRATA - CROSS -Towel Heater DIVIDERS

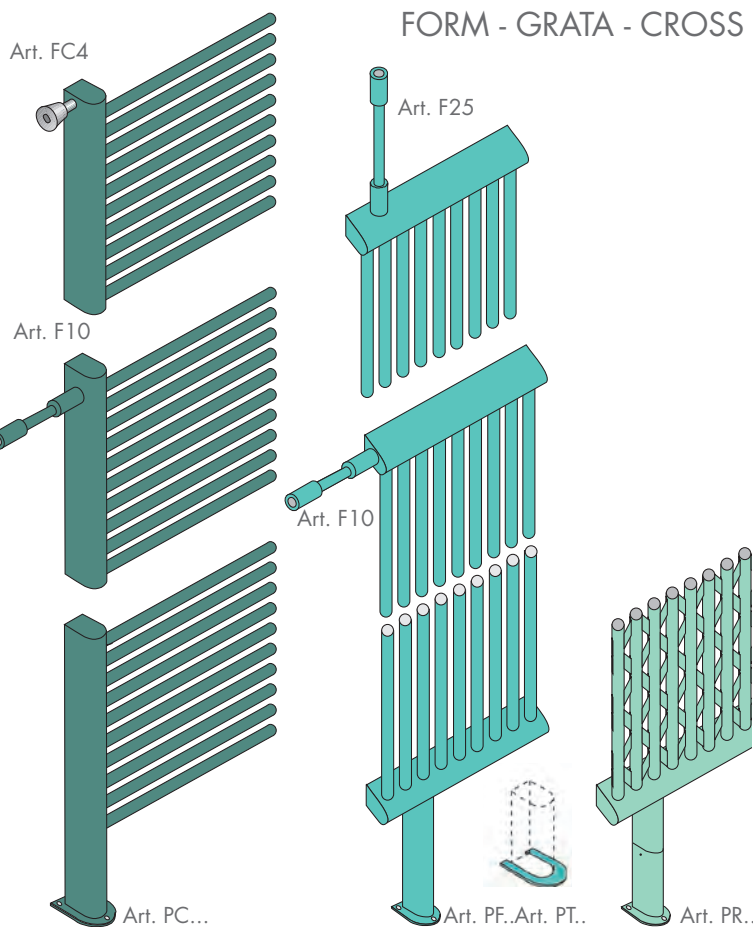

Feet and special fixing supports allow radiators and heated towel rails to be used as partitions, providing aesthetically pleasing interior designs.

FIXINGS

Painted side bracket 10 cm (can be reduced to 4 cm) Art. F10 83,90€

Painted ceiling bracket 25 cm (can be reduced to 4 cm) Art. F25 87,50€

Side chrome-plated bracket with sleeve Adjustment: 4/6 cm Art. FC4 71,80€

Bracket FC4 is screwed into sleeve M18 extra charge Art. M18 23,20€

Different length on request.

CROSS model Adjustable foot H 12/15 cm

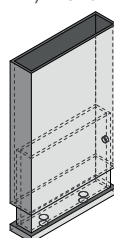

Art. PCV12
124,70€

FEET

Manifold foot
H cm 15 Art. PC15 100,10€
H cm 19 Art. PC19 100,10€

Fixed foot
standard H cm 15 Art. PF15 87,90€

Adjustable foot standard
H cm 15/20 Art. PR15 105,60€

Foot cover (covers the fixing screws) Art. PT... 36,60€

Made-to-measure length feet, on request.

BRACKETS

The thermoplastic resin or metal brackets allow for depth adjustment and are always included in the package.

Fix the provided brackets to the wall to install. The bottom of the bracket has an oval hole to allow for adjustment on the wall.

- Art. B15(mm)
- Art. B27(mm)
- Art. B35(mm)
- Art. B55(mm)
- Art. B70(mm)

Brackets:
(B) white 16,20€
(V) colored 20,40€



BRACKET	white (B)	colored (V)
Mod. EOS..	10,10€	13,80€
Mod. META		
Art. 105..	16,20€	20,40€
Art. 109..	16,20€	20,40€
Art. 111..	16,20€	20,40€

Mod. WIND		
Art. 131.. (w3-w4)	9,10€	13,30€
Art. 151.. (w5-w6)	9,10€	13,30€

Art. MH4..	16,20€	20,50€
Art. MH14..	27,40€	34,30€



White bracket (depth 8 cm) Art. M8B 17,00€
Art. M8KB 17,00€

Chrome-plated bracket (depth 8 cm) Art. M8C 26,20€
Art. M8KC 26,20€

White bracket (depth 4 cm): Art. M4B 13,70€
Art. M4GB 13,70€
Art. M4KB 18,00€
Art. M4FB 18,00€

Chrome-plated bracket Art. M4C 23,70€
Art. M4GC 23,70€
Art. M4KC 23,70€
Art. M4FC 28,90€



ACCESSORIES

design Davide Brembilla

RAM TOWEL-BAR

Towel holder in painted metal applicable with magnets on all steel panels, (35x44x7 cm)

Magnets capacity 3.5 kg

Art. RAM 173,90€

RAM standard colors: - grey sablé SB7039
- white sablé SB9016 - black sablé SB9005

In the color of the radiator ordered together +15/25%

On request in one paintwork to Brem color list different from the towel heater Suppl. Art. CM 52,90€



CLOTHES KNOB

Art. PA 83,20€

Chrome-plated knob for all the towel heaters with round tubes excluding PLUS 18



CHROME HOOK

Art. AC 96,70€

Chrome-plated hooks for all the towel heaters with round tubes excluding PLUS 18



Magnetic towel holder MAGNET

Magnetic towel holder in painted metal applicable on all steel plates.

(40x3,3x6,2 cm) Art. MAG40 144,50€

(50x3,3x6,2 cm) Art. MAG50 149,00€

MAGNET standard colors: - grey sablé SB7039
- white sablé SB9016 - black sablé SB9005

In the color of the radiator ordered together +15/25%

In other colors Brem Extra Art. CM 49,50€

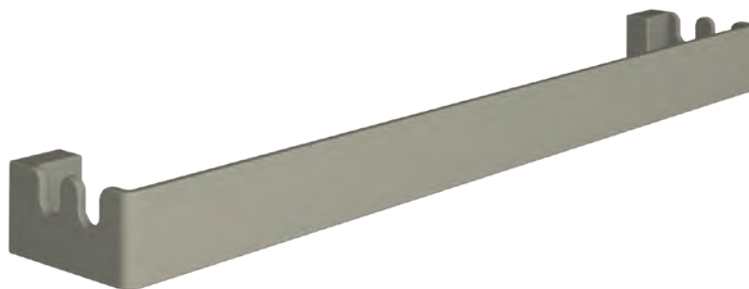

Magnetic KNOBS

Metal knobs paint in Brem colours and nickel-chrome base with magnet applicable on flat steel plates and tubes, load capacity 4 kg.

Standard KNOBS: - standard white SB9016

- grey sablé SB 7039 - sablé black SB9005

- same color ordered with the radiator

Wall coat KNOBS

design Luigi Brembilla

On request KNOBS with wall fixing

Supplement 5,60€

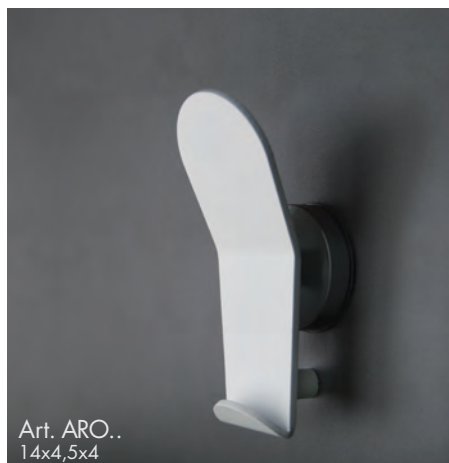

Art. ARO..
14x4,5x4

ARO MODEL

Art. ARC 95,50€

Painting up to 3 pieces per table color Brem
Extra 52,90€ - from 4 pieces +15/25%



Art. PO..
8,5x7x4

PO MODEL

Art. POC 95,50€

Painting up to 3 pieces per table color Brem
Extra 52,90€ - from 4 pieces +15/25%



Art. HK..
14x9x5

- with magnet

Art. HKC 95,50€

Painting up to 3 pieces per table color Brem
Extra 52,90€ - from 4 pieces +15/25%

FITTINGS

RADIATOR - TOWEL HEATER

The fittings used to connect the radiators to the heating system consist of two 1/2" or 3/8" diameter sleeves on the manifolds, according to each model.

The technical drawings for each model show how to calculate the distances between the fittings (tapping centres) as well as the min distance from the wall.

Fitting position
 ▲ - delivery
 ▼ - return
 S - air vent
 V - drain

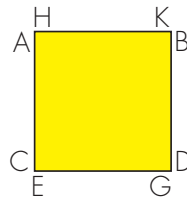

DUAL TUBE FITTINGS

This fitting is marked with letters showing the position of the other fittings:
 - the first shows the delivery
 - the second shows the return
 followed by the fitting diameter: e.g. AC ø 1/2"

DUAL TUBE FITTINGS



REVERSE DUAL TUBE FITTINGS

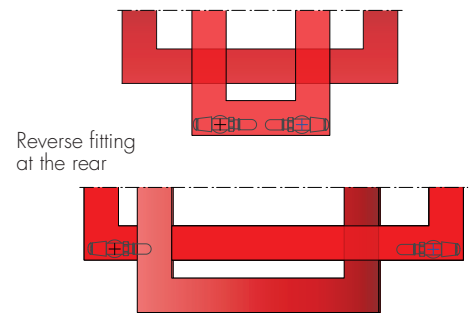
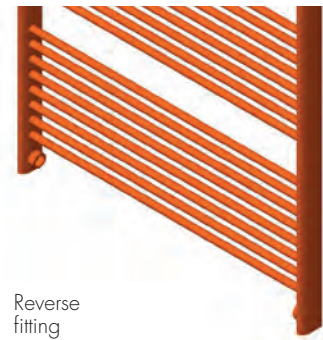

STANDARD FITTING ø 1/2" or 3/8"
 The radiator is produced with standard fittings as shown in the technical data.

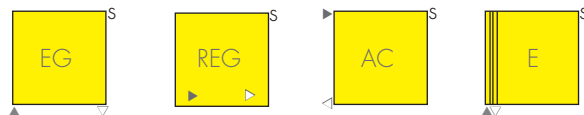

FITTINGS ON REQUEST no extra charge unless otherwise indicated according to the models

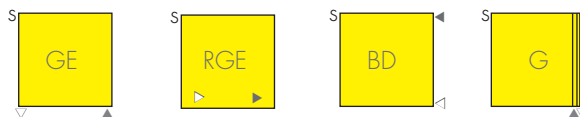

SPECIAL FITTINGS
 Side, reverse and vertical fittings different from standard productions, ask for feasibility
 Art. AS 91,20€

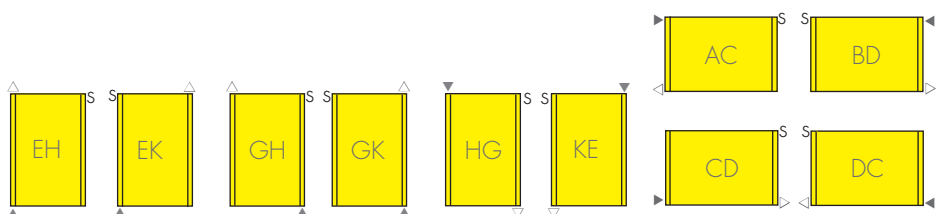

FITTINGS FOR DUAL TUBE VALVES

Fittings with 5 cm central tapping centre and inner probes (ask for feasibility)

Art. AS 91,20€

Special connections with 5 cm interaxis or made to measure with separators or any internal probes in the collector, (ask for feasibility)

Art. ASP 128,40€

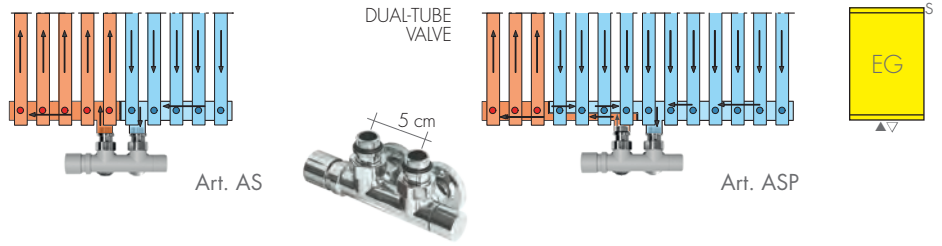

FITTINGS FOR SINGLE-TUBE SYSTEM with probe

The radiator is supplied by a $\varnothing 1/2"$ fitting (aligned to the manifold). The valve probe $\varnothing 10$ mm (other dimensions on request) passes through the hole of the inside separator where water goes in and out.

Standard single-tube fitting: $\varnothing 1/2"$ probe hole: $\varnothing 10$ mm Art. AM10 59,80€

The single-tube valve (p. 273) is supplied complete with 45 cm probe or small tube; on request:

Art. S70 probe L = 70 cm 13,60€

Art. S100 probe L = 100 cm 18,20€

Indicate the diameter of the fitting and probe if not standard.

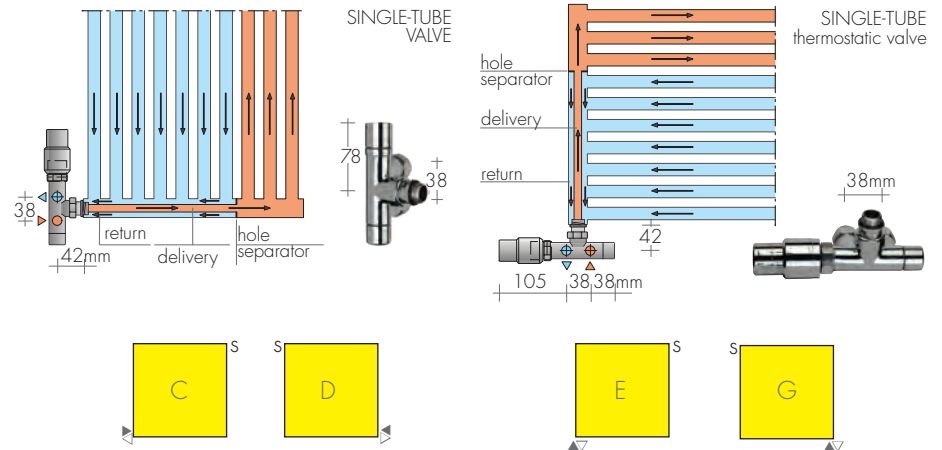

ASK FOR FEASIBILITY AND FITTINGS POSITION

The BREM $\varnothing 1/2"$ single-tube chrome-plated valve is fitted with $\varnothing 10$ mm probe. It can be either manual or thermostat controlled and is fitted with a flow deviator to reverse the delivery and return.

PLUGS AND AIR VENTS

Art. T18 ch-plated $\varnothing 1/8"$ plug 3,90€

Art. T14 ch-plated $\varnothing 1/4"$ plug 3,90€

Art. T38 ch-plated $\varnothing 3/8"$ plug 3,90€

Art. T12 ch-plated $\varnothing 1/2"$ plug 3,90€

Art. S18 ch-plated $\varnothing 1/8"$ air vent 3,90€

Art. S12 ch-plated $\varnothing 1/2"$ air vent 3,90€

TOWEL HEATER FRAME

Heated towel rail frame, painted in white, with fitting sleeves, heating element fittings and chrome-plated plug.

Art. CS 131,20€



SPECIAL FITTINGS ON REQUEST

Custom-made special fittings with special separators or internal probes in the manifold (ask for feasibility) Art. ASP 128,40€

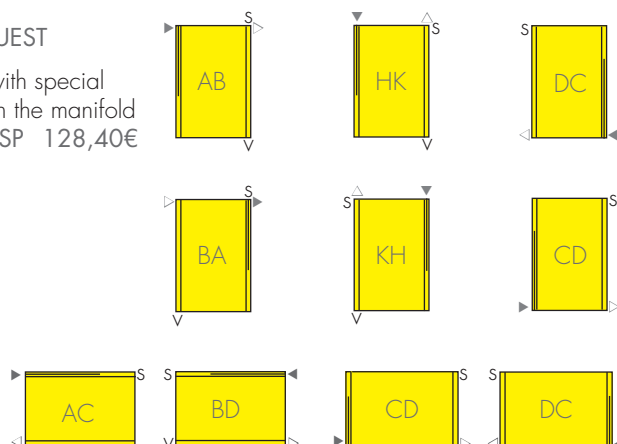

REMOTE VALVES FITTING

Fittings on the back $\varnothing 24F19$ (see page 274)

Art. REM 42,10€



INDEX BREM'ART

ARTISTS' RADIATORS

ART AND RADIATOR

Perennially in pursuit of new shapes and expressions that are also surprisingly practical in the garb given to heat, Brem asked artists to develop the theme with their own interpretations, inventions, and solutions.

This is "Brem'Art": a line of radiators designed by artists given complete freedom for the most creative expression of the function of heating.

EVERY WORK OF ART IS MADE BY HAND: THE MINIMUM IMPERFECTIONS AND IRREGULAR SHADING AND TONES OF COLOR ARE UNIQUE TO EACH PIECE AS IN EVERY REAL WORK OF ART.

BREM SPECIAL COLORS AND FINISHES

- BR 0001, a transparent metallic bright finish, highlights the signs of working on iron (welding, scoring, brushing, rings, marks, etc.); the phosphate greasing process enhances the colors of steel in shades of grey, beige, blue, brown, and dark green, and makes each piece unlike any other. This finish is a good example of "Rustic Art" and it is not available for the radiating plates.

- BR 0001 MS, a clear matte finish, transmits all the raw material's "brutality", whereas a shiny finish softens the look (not available for radiating plates).

- BR 0031 is a brushed-metal effect to hide scratches on the plates. Clear varnish.
- BR 0031 ST brushed-metal mat varnish.

- BR 0007 is the color that both comes closest to natural iron and best conceals possible imperfections.

- BR 0021 transparent polished finish, it transmits the brass effect, glimpsing weldings
- BR 0021 ST transparent mat finish

- BR 0022 BL polished and nuanced rust color finish
- BR 0022 sablé and nuanced rust color finish

Finishes, colors and extras are indicated for each work of art.

SPAZIO CHIUSO	II
MUN	III
FILU&FERRU	IV
BACCU MANDARA	V
CONFINI	VI
PERCORSO	VII
CONTINUUM SIPAR	VIII
ERUZIONE	IX
STROP'	X
CIRCO D'IDEE	XI
SCUDO DI ERACLE	XII
NOSTOS	XIII
FIRE	XIV
PINAK HOT	XV
EAGLE	XVI
GRID	XVII
SCHAG	XVIII
TERRA LUNARE	XIX
GRAFFI	XX
GRAFFI DI LUNA	XXI
PIET	XXII
VIRGO	XXIII



Panels: BREM'ART

The Brem'Art panels are built with a thickness of only 2,3cm. The valves can be hidden thanks to the higher cover.

The connections behind the cover allow the thermostatic head, partially visible, to operate by detecting the room temperature.

The electric version is produced with heights 180 and 200 cm and a protrusion of only 5.8 cm because of electrical devices.

DIMENSIONS HYDRAULIC VERSION

Height 187-207-227 cm
Width 36-45-54-63-72 cm
Depth 4.8-5.0cm
Depth from wall 7.8 cm

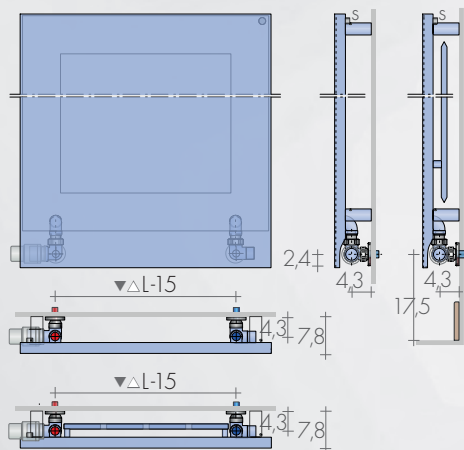
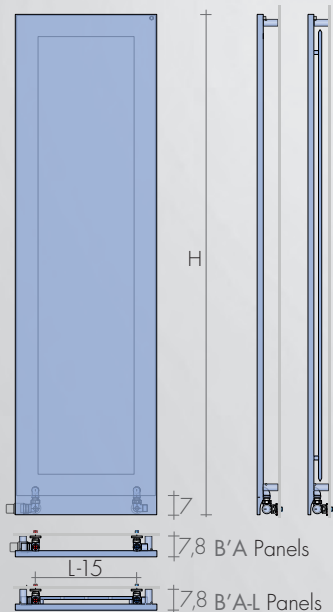

DIMENSIONS ELECTRIC VERSION

Height 180-200 cm
Width 36-45-54 cm
Depth 2.3-4.3 cm
Depth from wall 5.8 cm

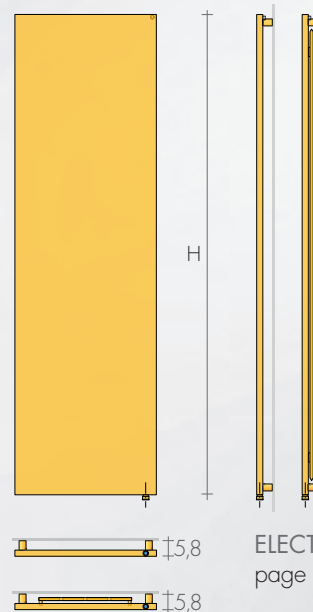

ELECTRIC DATA
page 208-211

STANDARD PRODUCTION

Tolerance ± 3 mm - Air vent $\varnothing 1/8"$
MAXIMUM OPERATING PRESSURE 4 BAR

STANDARD FITTING EG $\varnothing 1/2"$

B'A: Brem'Art panels
Tapping centres $\blacktriangledown \blacktriangle L-15$ cm



FIXINGS

Brackets included
Mod. Hydraulic B35 (*3)
Mod. Electric B55 (*10)



RECOMMENDED VALVES

Nickel-plated TON valves, raccords and handwheels



SIDE CONTROL TON VALVES KIT nickel-plated
easy control and chrome-plated handwheel
Art. KVLN 104,80€

KIT VALVOLE nichelate TON comando LATERALE,
testa TERMOSTATICA, Art. KTLND 143,80€

SIDE CONTROL TON VALVES KIT chrome
page 269 Art. KVL 150,50€

SIDE CONTROL TON VALVES KIT chrome with
thermostatic Head, p.269 Art. KTLD 203,70€

CHROME VALVES KIT with:

- n°2 Valves with tailpieces, Fittings (multilayer $\varnothing 16$,
copper $\varnothing 12-14$) and Wall plates $\varnothing 48$, hole $\varnothing 16$

Chrome-plated valves with painting supplement



SIDE CONTROL CYL Valves KIT with THERMO-
STATIC option, page 273 Art. KCLD 162,50€

SIDE CONTROL CYL Valves KIT chrome with
thermostatic Head, p.269 Art. KTLD 192,60€

VALVES KIT PAINTED in a color from the Brem color
EXTRA Art. VC 53,40€

COLORS THERMOSTATIC HEAD pag.266

FITTINGS KIT SPECIAL FINISHES for colored valves pag.266

(cone, raccord, washer in Or, Bronze, brushed nickel
KIT Fittings brushed Nickel Extra Art. RN 30,50€



ON REQUEST

Heights (H+7cm) and depth 5.5cm as in electric models,
are available for B'A panels with special fittings :

- FITTINGS EG $\blacktriangledown \blacktriangle L-4$ cm with visible valves

- REMOTE FITTINGS Art. REM 42,10€

Tapping centres: rear of radiator $\blacktriangledown \blacktriangle L-6$ cm

DISTANT Valves page 274



Rino Carrara proposes a model quite unlike the usual rigid radiator, adding the contents and shapes he loves to include in all his works to create an embracing overall design.

Color recommended by the artist: white sablé
SB 9016
Other colors BREM list without extra

RECOMMENDED VALVES

CHROME VALVES KIT with:
- n°2 Bitube Valve with tailpieces,
fittings (multilayer ø16, copper ø12-14)
and wall plates ø 48, hole ø16



STANDARD FITTING EG ø3/8" (or 1/2") ▲▽5 cm

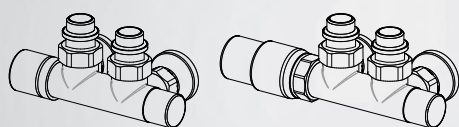

DUAL TUBE left CYL Valves KIT with Thermostatic option, ▲▽5 cm, pag. 273 Art. KCB 171,50€

DUAL TUBE left Valve KIT with THERMOSTATIC Head, ▲▽5 cm, pag. 274 Art. KTB 201,50€

Extra for BREM color list Extra Art. VC 53,40€
Brushed Nickel FITTING KIT extra Art. RN 30,50€



REMOTE CYL VALVES ASSEMBLY KIT, with (p.274)

Thermostatic option p.274 Art. KCG 224,30€

REMOTE CYL VALVES ASSEMBLY KIT with THERMOSTATIC head Art. KCGT 241,30€

Colored KIT color list Brem Extra Art. VC 53,40€

REMOTE FITTINGS Art. REM 42,10€

Tapping centres: at the rear ▲▽5 cm



SPAZIO CHIUSO

TON REMOTE Valves

MODEL'25

SPAZIO CHIUSO 145-95

EN 442 Watt Δt 50K (Δt 40K = Wx0,755) - (Δt 30K = Wx0,526)

EN 442 Watt Δt 50 K	▲▽ t.c. cm	Height cm	Width cm	Depth cm
1300	5	145	95	3

BREM colors list page 281

ELECTRIC VERSION NOT AVAILABLE



Filu&Ferru.
The name comes from an ancient Sardinian marc distillate.
It is a transparent, strong and generous beverage, deep warmth for tasters and delight for givers. It is family and home intimacy in winter. It is a refreshing and invigorating taste.
I've thought of the name for this Brem radiator because of resonant echoes name "Filo & Ferru" (thread & iron) and for home warmth, hospitality and intimacy.

BREM'ART CREATIONS

Steel artwork on matt black background 143 x15x2 cm; the artist suggests the panel in sablé quartz grey color SB 7039.

Other table sablé colors Brem without extra.

RECOMMENDED VALVES (pag.II)

CHROME VALVES KIT with:
n°2 Valves with tang, n°2 Fittings (multilayer ø16, copper ø12, 14), n°2 wall plates ø 48, hole ø16

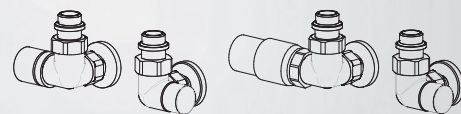

STANDARD FITTING EG ø 1/2"
Tapping centres ▲▽ L- 15 cm
Special fittings page 278



FILU&FERRU 187-45

CYL REMOTE Valves

EN 442 Watt Δt 50K (Δt 40K = Wx0,755) - (Δt 30K = Wx0,526)

MODEL'25	H cm	L cm	EN 442 Watt Δt 50K (Δt 40K = Wx0,755) - (Δt 30K = Wx0,526)				
			36	45	54	63	72
FILU	187	21	2056,00	2161,00	2270,40	2378,30	2482,90
			713w	887w	1061w	1233w	1407w
FILU-L	187	21	2386,60	2508,70	2658,50	2794,40	2929,60
			909w	1181w	1453w	1723w	1996w
FILU	207	21	2116,70	2230,40	2336,80	2449,20	2560,10
			792w	985w	1178w	1369w	1562w
FILU-L	207	21	2495,90	2641,20	2799,00	2934,50	3080,20
			1011w	1313w	1616w	1916w	2219w
FILU	227	21	2187,40	2305,90	2439,50	2546,40	2664,90
			870w	1082w	1294w	1504w	1716w
FILU-L	227	21	2558,40	2709,50	2873,80	3014,90	3165,90
			1112w	1445w	1778w	2109w	2441w

ELECTRIC VERSION

MODEL'25	H - L cm	Standard color €	KIT RE /KIT RT p.208	
			Câble R..E /Faston R..T Art. (WV) €	€
FILU	180-36	2056,00	R800II..	240,50
FILU	180-45	2161,00	R900II..	255,30
FILU	200-54	2336,80	R1200II..	276,30
FILU-L	180-45	2508,70	R1200II..	276,30
FILU-L	180-54	2658,50	R1500II..	298,00

REMOTE FITTINGS (H-7cm) page II
DISTANT Valves page 274



BREM colors list page 281

Technical data B'A Panels page II

Interpretation by Stefano Soddu:
BACCU MANDARA

The sea is grey, the sky yellow.
A piece of sea evaporates in the sky
and obscures it with triangular projection.
Like a kite, waiting for the rain.

BREM'ART CREATIONS

Colors sablé rust nuanced SB 0022 and
sablé quartz grey SB 7039 recommended
by the artist.

Other colours on request, no extra charge

RECOMMENDED VALVES (pag.11)

CHROME VALVES KIT with:
n°2 Valves with tang, n°2 Fittings (multilayer ø16,
copper ø12, 14), n°2 wall plates ø 48, hole ø16

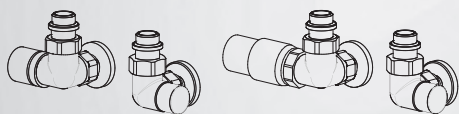

STANDARD FITTING EG ø 1/2"
Tapping centres ▲▽ L- 15 cm
Special fittings page 278



BACCU MANDARA 187-54

CYL Valve with THERMOSTATIC Head

MODEL	Standard		KIT RE/KIT RT p.208	
	H - L cm	color €	Câble R..E/Faston R..T Art. (WV) €	Art. (WV) €
BAC 180-36	2072,80	R800II..	240,50	
BAC 180-45	2189,00	R900II..	255,30	
BAC 200-54	2697,70	R1200II..	276,30	
BACL 180-45	2536,70	R1200II..	276,30	
BACL 180-54	2697,70	R1500II..	298,00	

Es: BAC 180-45 SB 7039 2189,00€ +
Kit electric R900II.. + Thermostat pag. 208-209

ON REQUEST (H-7cm, depth f/wall 5,8cm) pag.11
- FITTINGS EG ▲▽ L- 4 cm with visible valves.
- REMOTE FITTINGS con REMOTE Valves p.274

MODEL	H cm	L cm ▲▽cm	EN 442 Watt Δt 50K (Δt 40K = Wx0,755) - (Δt 30K = Wx0,526)					
			36	45	54	63	72	
BAC 187 €	2072,80	21	2189,00	2309,60	2428,70	2544,50		
BACL 187 €	2403,40	21	2536,70	2697,70	2844,80	2991,20		
BAC 207 €	2133,50	30	2258,40	2376,00	2499,60	2621,70		
BACL 207 €	2512,70	30	2669,20	2838,20	2984,90	3141,80		
BAC 227 €	2204,20	39	2333,90	2478,70	2596,80	2726,50		
BACL 227 €	2575,20	39	2737,50	2913,00	3065,30	3227,50		

BREM colors list page 281

Technical data B'A Panels page 11



CAPITONNÉ 187-54

CYL Valve with THERMOSTATIC Head

The effect of the quilting, arranged on a network of squares, is transferred to the metal surface of the B'A plate to evoke a fashion that has remained in the history of furniture.

BREM'ART CREATIONS (page I)

Color recommended by the artist SB 0022
Sablé rust nuanced.

Sablé standard painting at the choice,
without extra.

RECOMMENDED VALVES (pag.II)

CHROME VALVES KIT with:
n°2 Valves with tang, n°2 Fittings (multilayer ø16,
copper ø12, 14), n°2 wall plates ø 48, hole ø16

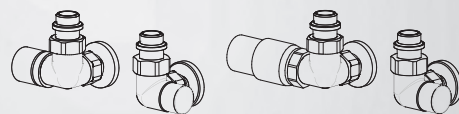

STANDARD FITTING EG ø 1/2"
Tapping centres ▲▼ L - 15 cm
Special fittings page 278



MODEL'25	H cm	L cm	EN 442 Watt Δt 50K (Δt 40K = Wx0,755) - (Δt 30K = Wx0,526)				
			▲▼cm	36	45	54	63
CAPH	187	€	1988,80	2110,60	2236,80	2361,50	2482,90
			713w	887w	1061w	1233w	1407w
CAPLH	187	€	2319,40	2458,30	2624,90	2777,60	2929,60
			909w	1181w	1453w	1723w	1996w
CAPH	207	€	2049,50	2180,00	2303,20	2432,40	2560,10
			792w	985w	1178w	1369w	1562w
CAPLH	207	€	2428,70	2590,80	2765,40	2917,70	3080,20
			1011w	1313w	1616w	1916w	2219w
CAPH	227	€	2120,20	2255,50	2405,90	2529,60	2664,90
			870w	1082w	1294w	1504w	1716w
CAPLH	227	€	2491,20	2659,10	2840,20	2998,10	3165,90
			1112w	1445w	1778w	2109w	2441w

MODEL'25	H - L cm	Standard color	ELECTRIC VERSION	
			Kit RE / KIT RT p.208	Art. (WV) €
CAPH	180-36	1988,80	R800II..	240,50
CAPH	180-45	2110,60	R900II..	255,30
CAPH	200-54	2303,20	R1200II..	276,30
CAPLH	180-45	2458,30	R1200II..	276,30
CAPLH	180-54	2624,90	R1500II..	298,00

Es: CAPH 180-45 SB 0022 2110,60€ +
Electric Kit R900II.. + Thermostat pag. 208-209

ON REQUEST (H-7cm, depth f/wall 5,8cm) pag.II
- FITTINGS EG ▲▼ L - 4 cm with visible valves.
- REMOTE FITTINGS con REMOTE Valves p.274

A white radiant panel with the three-colour artistic composition that recalls the work that evoke compositional works created in the 90s.

BREM'ART CREATIONS (page I)

Colourful composition 20 x 20 cm,
B'A panel satin cream white Ral 9001-S.

Brem colours only on the B'A panel



MUN 187-45

CYL Valve with THERMOSTATIC option

RECOMMENDED VALVES (pag.II)

CHROME VALVES KIT with:
n°2 Valves with tang, n°2 Fittings (multilayer ø16,
copper ø12, 14), n°2 wall plates ø 48, hole ø16

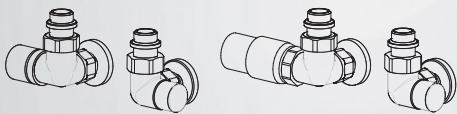

STANDARD FITTING EG ø 1/2"
Tapping centres ▲▼ L- 15 cm
Special fittings page 278



ELECTRIC VERSION			
MODEL	Standard	KIT RE/KIT RT p.208	
⚡	H - L cm	color €	Câble R..E/Faston R..T Art. (WV) €
MUN 180-36	2016,80	R800II..	240,50
MUN 180-45	2121,80	R900II..	255,30
MUN 200-54	2297,60	R1200II..	276,30
MUNL 180-45	2469,50	R1200II..	276,30
MUNL 180-54	2619,30	R1500II..	298,00
Es: MUN 180-45 Ral 9001-S 2121,80€ + Electric Kit R900II.. + Thermostat pag. 208-209			

		EN 442 Watt Δt 50K (Δt 40K = Wx0,755) - (Δt 30K = Wx0,526)					
MODEL	H cm	L cm	36	45	54	63	72
		▲▼cm	21	30	39	48	57
MUN	187	€	2016,80 713w	2121,80 887w	2231,20 1061w	2339,10 1233w	2443,70 1407w
MUNL	187	€	2347,40 909w	2469,50 1181w	2619,30 1453w	2755,20 1723w	2890,40 1996w
MUN	207	€	2077,50 792w	2191,20 985w	2297,60 1178w	2410,00 1369w	2520,90 1562w
MUNL	207	€	2456,70 1011w	2602,00 1313w	2759,80 1616w	2895,30 1916w	3041,00 2219w
MUN	227	€	2148,20 870w	2266,70 1082w	2400,30 1294w	2507,20 1504w	2625,70 1716w
MUNL	227	€	2519,20 1112w	2670,30 1445w	2834,60 1778w	2975,70 2109w	3126,70 2441w

ON REQUEST (H-7cm, depth f/wall 5,8cm) pag.II
- FITTINGS EG ▲▼ L- 4 cm with visible valves.
- REMOTE FITTINGS con REMOTE Valves p.274

BREM colors list page 281

Technical data B'A Panels page II

CONTINUUM TRE SIPAR.W

RAFFAELE CIOFFI



CONTINUUM TRE 187-54

CYL Valve with THERMOSTATIC option



SIPAR.W 187-54

CYL Valve with THERMOSTATIC Head

Raffaele Cioffi has interpreted warmth by adding 3D effect moulds to the radiator, printed using special heat resistant inks.

The works in the "CONTINUUM and SIPAR.W" series excite the emotions and feature alternating color schemes, thanks to a play of light and shadow

CONTINUUM TRE (H 45 x L 20 cm)
Screen printing,
Color recommended by the artist, BR 0007.

SIPAR.W (H 100 x L 25 cm)
White screen printing.
Color recommended by the artist, SB 3061

Brem colours only on the B'A panel, without extra.

RECOMMENDED VALVES (pag.II)

CHROME VALVES KIT with:
n°2 Valves with tang, n°2 Fittings (multilayer ø16, copper ø12, 14), n°2 wall plates ø 48, hole ø16

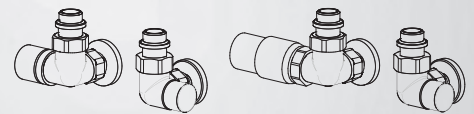

STANDARD FITTING EG ø 1/2"
Tapping centres ▲▼ L - 15 cm
Special fittings page 278



MODEL'25		EN 442 Watt Δt 50K (Δt 40K = Wx0,755) - (Δt 30K = Wx0,526)					
SB 9016	H cm	L cm	36	45	54	63	72
		▲▼cm	21	30	39	48	57
A*..H	187 €		1927,20 713w	2032,20 887w	2141,60 1061w	2249,50 1233w	2354,10 1407w
A*..LH	187 €		2257,80 909w	2379,90 1181w	2529,70 1453w	2665,60 1723w	2800,80 1996w
A*..H	207 €		1987,90 792w	2101,60 985w	2208,00 1178w	2320,40 1369w	2431,30 1562w
A*..LH	207 €		2367,10 1011w	2512,40 1313w	2670,20 1616w	2805,70 1916w	2951,40 2219w
A*..H	227 €		2058,60 870w	2177,10 1082w	2310,70 1294w	2417,60 1504w	2536,10 1716w
A*..LH	227 €		2429,60 1112w	2580,70 1445w	2745,00 1778w	2886,10 2109w	3037,10 2441w

A*.. C continuum - S sipar.w
BREM colors list page 281

Technical data B'A Panels page II

ELECTRIC VERSION

MODEL'25	Standard	KIT RE /KIT RT p.208
H - L	colorf	Cable R..E/Faston R..T
cm	€	Art. (W) €
A*..H 180-36	1927,20	R800II.. 240,50
A*..H 180-45	2032,20	R900II.. 255,30
A*..H 200-54	2208,00	R1200II.. 276,30
A*..LH 180-45	2379,90	R1200II.. 276,30
A*..LH 180-54	2529,70	R1500II.. 298,00
Es: ACH180-45 continuum BR 0007 2032,20€		
Es: ASLH 180-45 sipar.w SB3061 2379,90€ +		
+ Electric Kit R..00II.. + Thermostat page 208-209		
ON REQUEST (H-7cm, depth f/wall 5,8cm) pag.II		
- FITTINGS EG ▲▼ L - 4 cm with visible valves.		
- REMOTE FITTINGS con REMOTE Valves p.274		

Steven Cavagna has opted here to use precious gilded leaf details set against an oxidised steel background.

An imaginary stream of cast gold arousing the imagination.

The stream is hand-made and always different for each radiator.

BREM'ART CREATIONS (page I)

Bright shaded rust BR 0022 BL and gilded leaf

Other BREM colors to quote



ERUZIONE 207-36

RECOMMENDED VALVES (pag.II)

CHROME VALVES KIT with:
n°2 Valves with tang, n°2 Fittings (multilayer ø16, copper ø12, 14), n°2 wall plates ø 48, hole ø16

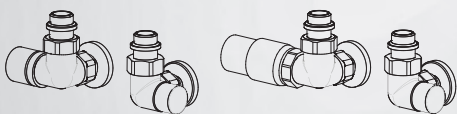

STANDARD FITTING EG ø 1/2"

Tapping centres ▲▽ L- 15 cm

Special fittings page 278



CYL Valve with THERMOSTATIC Head

ELECTRIC VERSION				EN 442 Watt Δt 50K (Δt 40K = Wx0,755) - (Δt 30K = Wx0,526)						
MODEL'25	Color	KIT RE/KIT RT p.208	MODEL'25	L cm	36	45	54	63	72	
⚡	H - L	BRO022BL	Cable R..E/Faston R..T	H cm	▲▽cm	30	39	48	57	
	cm	€	Art. (W) €							
ERH	180-36	2050,40	R800II.. 240,50	ERH	187 €	2050,40	2189,00	2320,80	2451,10	2589,30
						713w	887w	1061w	1233w	1407w
ERH	180-45	2189,00	R900II.. 255,30	ERLH	187 €	2381,00	2536,70	2708,90	2867,20	3036,00
						909w	1181w	1453w	1723w	1996w
ERH	200-54	2387,20	R1200II.. 276,30	ERH	207 €	2111,10	2258,40	2387,20	2522,00	2666,50
						792w	985w	1178w	1369w	1562w
ERLH	180-45	2536,70	R1200II.. 276,30	ERLH	207 €	2490,30	2669,20	2849,40	3007,30	3186,60
						1011w	1313w	1616w	1916w	2219w
ERLH	180-54	2708,90	R1500II.. 298,00	ERLH	227 €	2181,80	2333,90	2489,90	2619,20	2771,30
						870w	1082w	1294w	1504w	1716w
Es:	ERH 180-45	BRO022BL	2189,00€	ERLH	227 €	2552,80	2737,50	2924,20	3087,70	3272,30
	+ Electric Kit	R900II..	+ Thermostat pag. 208-209			1112w	1445w	1778w	2109w	2441w

ON REQUEST (H-7cm, depth f/wall 5,8cm) pag.II

- FITTINGS EG ▲▽ L- 4 cm with visible valves.

- REMOTE FITTINGS con REMOTE Valves p.274

BREM colors list page 281

Technical data B'A Panels page II



STROP 207-54

STROP 207-45

CYL Valve with THERMOSTATIC Head

Light plays and reflects on the irregular surface to create unexpected, ever-changing effects. The colour is an important part of the work.

Each item is carefully crafted by hand, meaning that no two items are ever the same.

BREM'ART CREATIONS (page I)
 BREM sablé colors paintworks without extra.
 Other BREM colors on request.

RECOMMENDED VALVES (pag.II)

CHROME VALVES KIT with:
 n°2 Valves with tang, n°2 Fittings (multilayer ø16, copper ø12, 14), n°2 wall plates ø 48, hole ø16

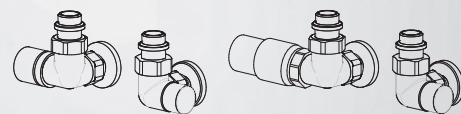

STANDARD FITTING EG ø 1/2"
 Tapping centres ▲▽ L - 15 cm
 Special fittings page 278



MODEL'25		EN 442 Watt Δt 50K (Δt 40K = Wx0,755) - (Δt 30K = Wx0,526)					
SB 9016	H cm	L cm	36	45	54	63	72
		▲▽cm	21	30	39	48	57
SRH	187	€	2072,80 713w	2189,00 887w	2309,60 1061w	2428,70 1233w	2544,50 1407w
SRLH	187	€	2403,40 909w	2536,70 1181w	2697,70 1453w	2844,80 1723w	2991,20 1996w
SRH	207	€	2133,50 792w	2258,40 985w	2376,00 1178w	2499,60 1369w	2621,70 1562w
SRLH	207	€	2512,70 1011w	2669,20 1313w	2838,20 1616w	2984,90 1916w	3141,80 2219w
SRH	227	€	2204,20 870w	2333,90 1082w	2478,70 1294w	2596,80 1504w	2726,50 1716w
SRLH	227	€	2575,20 1112w	2737,50 1445w	2913,00 1778w	3065,30 2109w	3227,50 2441w

MODEL'25		ELECTRIC VERSION	
H - L	Standard colors	KIT RE /KIT RT p.208	Cable R..E/Faston R..T
cm	€	Art. (W)	€
SRH 180-36	2072,80	R800II..	240,50
SRH 180-45	2189,00	R900II..	255,30
SRH 200-54	2376,00	R1200II..	276,30
SRLH 180-45	2536,70	R1200II..	276,30
SRLH 180-54	2697,70	R1500II..	298,00
Es: SRH 180-45 Ral9005-M 2189,00€			
+ Electric Kit R900II.. + Thermostat pag. 208-209			

BREM colors list page 281

Technical data B'A Panels page II

ON REQUEST (H-7cm, depth f/wall 5,8cm) pag.II
 - FITTINGS EG ▲▽ L - 4 cm with visible valves.
 - REMOTE FITTINGS con REMOTE Valves p.274

Steven Cavagna has rudely played around with the material, using the Plasma cutting technique to manually drill a steel plate. The result is a series of irregularities in the metal created by these holes and the burn marks, giving it its significant and unmistakable character.

Brem makes it using the B'A panel.

BREM'ART CREATIONS (page I)

Finish in similar brass shaded and transparent satin varnish BR 0021-S.

RECOMMENDED VALVES (pag.II)

CHROME VALVES KIT with:
n°2 Valves with tang, n°2 Fittings (multilayer ø16, copper ø12, 14), n°2 wall plates ø 48, hole ø16

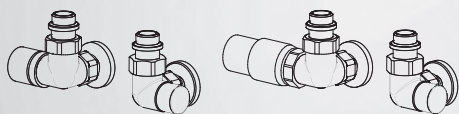

STANDARD FITTING EG ø 1/2"
Topping centres ▲▽ L- 15 cm
Special fittings page 278



CIRCO D'IDEE 187-45

CYL Valve with THERMOSTATIC option

ELECTRIC VERSION				EN 442 Watt Δt 50K (Δt 40K = Wx0,755) - (Δt 30K = Wx0,526)				
MODEL'25	Standard	KIT RE /KIT RT p.208	MODEL'25	L cm	36	45	54	63
H - L	colors	Cable R..E/Faston R..T	SB 9016	▲▽cm	21	30	39	48
cm	€	Art. (W) €	CRH	H cm	2128,80	2256,20	2388,00	2518,30
CRH 180-45	2256,20	R900II.. 255,30	CRH	187	713w	887w	1061w	1233w
CRH 200-54	2454,40	R1200II.. 276,30	CRLH	187	2459,40	2603,90	2776,10	2934,40
CRLH 180-45	2603,90	R1200II.. 276,30	CRH	207	909w	1181w	1453w	1723w
CRLH 180-54	2776,10	R1500II.. 298,00	CRH	207	2189,50	2325,60	2454,40	2589,20
Es: CRH 180-45	BR0021-S	2256,20€	CRLH	207	792w	985w	1178w	1369w
+ Electric Kit R900II..	+ Thermostat	pag. 208-209	CRLH	207	2568,70	2736,40	2916,60	3074,50
			CRH	227	1011w	1313w	1616w	1916w
			CRH	227	2260,20	2401,10	2557,10	2686,40
			CRLH	227	870w	1082w	1294w	1504w
			CRLH	227	2631,20	2804,70	2991,40	3154,90
					1112w	1445w	1778w	2109w

ON REQUEST (H-7cm, depth f/wall 5,8cm) pag.II
- FITTINGS EG ▲▽ L- 4 cm with visible valves.
- REMOTE FITTINGS con REMOTE Valves p.274

BREM colors list page 281

Technical data B'A Panels page II



Dedicated to the greatest antique greek hero, Scudo di Eracle is made of copper by the artist for BREM'ART. Antonio Pizzolante, with his own hands, creates the shield of Heracles out of copper; once again the artist joins together form and function, beyond the time.

SCUDO DI ERACLE (H 98 x L 28cm)

The artist suggests the plate in SB 0022 sablé rust nuanced color.

Note that this color nuance is not repeatable and has stains and tons always different, that make it unique.

BREM sablé colors paintworks without extra.

RECOMMENDED VALVES (pag.II)

CHROME VALVES KIT with:
n°2 Valves with tang, n°2 Fittings (multilayer ø16, copper ø12, 14), n°2 wall plates ø 48, hole ø16

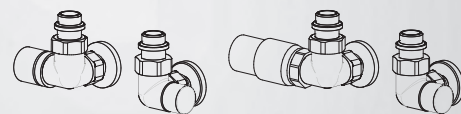

STANDARD FITTING EG ø 1/2"
Tapping centres ▲▼ L - 15 cm
Special fittings page 278



SCUDO DI ERACLE 207-54

CYL Valve with THERMOSTATIC Head

EN 442 Watt Δt 50K (Δt 40K = Wx0,755) - (Δt 30K = Wx0,526)

MODEL'25	H cm	L cm	EN 442 Watt Δt 50K (Δt 40K = Wx0,755) - (Δt 30K = Wx0,526)				
			36	45	54	63	72
SEH	187	€	2291,20 713w	2396,20 887w	2505,60 1061w	2613,50 1233w	2718,10 1407w
SELH	187	€	2621,80 909w	2743,90 1181w	2893,70 1453w	3029,60 1723w	3164,80 1996w
SEH	207	€	2351,90 792w	2465,60 985w	2572,00 1178w	2684,40 1369w	2795,30 1562w
SELH	207	€	2731,10 1011w	2876,40 1313w	3034,20 1616w	3169,70 1916w	3315,40 2219w
SEH	227	€	2422,60 870w	2541,10 1082w	2674,70 1294w	2781,60 1504w	2900,10 1716w
SELH	227	€	2793,60 1112w	2944,70 1445w	3109,00 1778w	3250,10 2109w	3401,10 2441w

ELECTRIC VERSION

MODEL'25	H - L cm	Standard color €	KIT RE /KIT RT p.208	
			Cable R..E/Faston R..T Art. (W) €	€
SEH	180-36	2291,20	R800II..	240,50
SEH	180-45	2396,20	R900II..	255,30
SEH	200-54	2572,00	R1200II..	276,30
SELH	180-45	2743,90	R1200II..	276,30
SELH	180-54	2893,70	R1500II..	298,00
Es: SEH180-45 SB 0022 2396,20€				
+ Electric Kit R900II.. + Thermostat pag. 208-209				

ON REQUEST (H-7cm, depth f/wall 5,8cm) pag.II
- FITTINGS EG ▲▼ L - 4 cm with visible valves.
- REMOTE FITTINGS con REMOTE Valves p.274

Nostos creates a warm and welcoming feel, designed to act as a multi-sensory link between everyday objects and people's most intimate experiences.

A metaphor for a personal journey exploring the relationship between space and home. In fact, the artist defines Nostos as the archetype of Odysseus' own "homecoming", as the story of an unpredictable journey, capable of changing the aspects of life.

BREM'ART CREATIONS (page I)

The work Nostos is hand painted by the artist and with the color line Ultramarine Blue Ral 5002 (standard); on request, the line, in the color Yellow Ochre Ral 1032, Pompeii Red Ral 3011, Patina Green Ral 6000.

The artist proposes the panels in Sablè quartz grey color SB 7039.

BREM sablé colors paintworks without extra.

RECOMMENDED VALVES (pag.II)

CHROME VALVES KIT with:
n°2 Valves with tang, n°2 Fittings (multilayer ø16, copper ø12, 14), n°2 wall plates ø 48, hole ø16

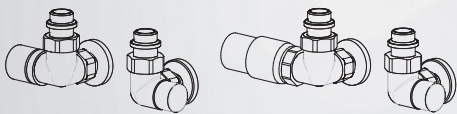

STANDARD FITTING EG ø 1/2"
Topping centres ▲▼ L - 15 cm
Special fittings page 278



NOSTOS 187-45

CYL Valve with THERMOSTATIC option

ELECTRIC VERSION			
MODEL'25	Standard	KIT RE /KIT RT p.208	
H - L	color	Cable R..E/Faston R..T	Art. (W) €
cm	€		
N.. 180-45	2250,60	R900II..	255,30
N.. 200-54	2454,40	R1200II..	276,30
N..-L 180-45	2598,30	R1200II..	276,30
N..-L 180-54	2776,10	R1500II..	298,00
Es: NOSTOS 180-45 SB 7039 2454,40€			
+ Electric Kit R900II.. + Termostat pag. 208-209			

ON REQUEST (H-7cm, depth f/wall 5,8cm) pag.II
- FITTINGS EG ▲▼ L - 4 cm with visible valves.
- REMOTE FITTINGS con REMOTE Valves p.274

MODEL'25	H cm	L cm	▲▼cm
NOSTOS 187	€	45 30	63 48
NOSTOS-L 187	€	2250,60 887w	2388,00 1061w
NOSTOS 207	€	2598,30 1181w	2776,10 1453w
NOSTOS 207	€	2320,00 985w	2454,40 1178w
NOSTOS-L 207	€	2730,80 1313w	2916,60 1616w
NOSTOS 227	€	2395,50 1082w	2557,10 1294w
NOSTOS-L 227	€	2799,10 1445w	2991,40 1778w

BREM colors list page 28 I

EN 442 Watt Δt 50K (Δt 40K = Wx0,755) - (Δt 30K = Wx0,526)			
		45	54
		30	39
NOSTOS 187	€	2250,60	2388,00
NOSTOS-L 187	€	2598,30	2776,10
NOSTOS 207	€	2320,00	2454,40
NOSTOS-L 207	€	2730,80	2916,60
NOSTOS 227	€	2395,50	2557,10
NOSTOS-L 227	€	2799,10	2991,40
		887w	1061w
		1181w	1453w
		985w	1178w
		1313w	1616w
		1082w	1294w
		1445w	1778w
		1233w	1504w
		1723w	2109w
		2594,80	2692,00
		3080,10	3160,50
		2523,90	2940,00

Technical data B'A Panels page II



Flashing light marks on a shaded mirror, hand-engraved by the artist Nicola Evangelisti, glare of light a fragment of red lava Murano glass (30x30cm).

Light, warmth and reflection bring together art and design in a unique and special way.

BREM'ART CREATIONS (page I)

The artist suggests the panels in Sablè quartz grey color SB 7039.

Other table sablè colors Brem without supplement.

RECOMMENDED VALVES (pag.II)

CHROME VALVES KIT with:

n°2 Valves with tang, n°2 Fittings (multilayer ø16, copper ø12, 14), n°2 wall plates ø 48, hole ø16

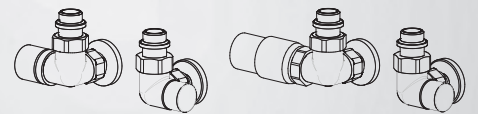

STANDARD FITTING EG ø 1/2"
Tapping centres ▲▽ L - 15 cm
Special fittings page 278

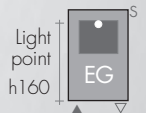

FIRE 187-54

CYL Valve with THERMOSTATIC Head

		EN 442 Watt Δt 50K (Δt 40K = Wx0,755) - (Δt 30K = Wx0,526)				
MODEL'25	H cm	L cm	45	54	63	72
		▲▽cm	30	39	48	57
FIRE	187	€	2065,80 887w	2175,20 1061w	2283,10 1233w	2387,70 1407w
FIRE-L	187	€	2413,50 1181w	2563,30 1453w	2699,20 1723w	2834,40 1996w
FIRE	207	€	2135,20 985w	2241,60 1178w	2354,00 1369w	2464,90 1562w
FIRE-L	207	€	2546,00 1313w	2703,80 1616w	2839,30 1916w	2985,00 2219w
FIRE	227	€	2210,70 1082w	2344,30 1294w	2451,20 1504w	2569,70 1716w
FIRE-L	227	€	2614,30 1445w	2778,60 1778w	2919,70 2109w	3070,70 2441w

		ELECTRIC VERSION	
MODEL'25	H - L cm	Standard color €	KIT RE /KIT RT p.208 Cable R..E/Faston R..T Art. (W) €
FIRE	180-45	2065,80	R900II.. 255,30
FIRE	200-54	2241,60	R1200II.. 276,30
FIRE-L	180-45	2413,50	R1200II.. 276,30
FIRE-L	180-54	2563,30	R1500II.. 298,00

Es: FIRE 180-45 SB 7039 2065,80€+
Kit electric R900II.. + Thermostat pag. 208-209

ON REQUEST (H-7cm, depth f/wall 5,8cm) pag.II
- FITTINGS EG ▲▽ L - 4 cm with visible valves.
- REMOTE FITTINGS con REMOTE Valves p.274

A large crystal mirror is crossed by a flash of white light (Lightsquare 30x30cm, Pinakhot-2 150x30cm, Luxury Lux 150x7cm). The black crystal is framed by the radiator.

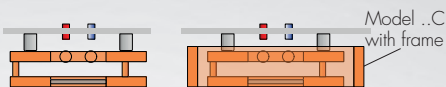

The artist proposes the radiator in black 9005 BREM colors paintworks without extra.



TON REMOTE Valves

RECOMMENDED VALVES

CHROME VALVES KIT with: Valves with tang, Fittings (multilayer ø16, copper ø12, 14), and wall plates ø 48, hole ø16

DUAL TUBE CYL Valve KIT with Thermostatic option, ▲▽ 5cm, pag. 273 Art. KCB 171,50€

DUAL TUBE CYL Valve KIT with THERMOSTATIC Head, ▲▽ 5cm, pag. 274 Art. KTB 201,50€

In Brem color list EXTRA Art. VC 53,40€

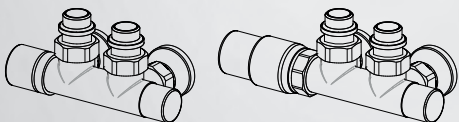

STANDARD FITTING

EG ø3/8" ▲▽ 5 cm
On request ø1/2"



REMOTE CYL VALVES ASSEMBLY KIT, with (p.274) Thermostatic option p.274 Art. KCG 224,30€

REMOTE CYL VALVES ASSEMBLY KIT with THERMOSTATIC head Art. KCGT 241,30€

Brushed Nickel FITTING KIT extra Art. RN 30,50€

REMOTE FITTINGS (▲▽ L-6 cm) p. II
DISTANT Valves page 274



MODEL'25

	H - L cm	Standard color €	EN 442 Watt Δt 50 K	▲▽ t.c. cm	Depth cm	KIT RE / KIT RT p.208 Cable R..E/Faston R..T Art. (W) €
LIGHTSQUARE	50-50	1347,20	289	5	9	R300II.. 193,80
LIGHTSQUARE-C	58-58	1709,50	523	5	9	R500II.. 208,50
PINAKHOT-2	172-50	2506,30	756	5	9	R800II.. 240,50
PINAKHOT-C	180-58	2868,50	1245	5	9	R1200II.. 276,30
LUXURY LUX	172-27	1398,10	654	5	9	R650II.. 222,90
LUXURY LUX-C	180-35	1774,80	1095	5	9	R1200II.. 276,30

BREM colors list +15/+25% page 281

A radiant plate, with the addition of sheets and tubes to obtain an original and dynamic plastic effect, made on the Clak model.

BREM'ART CREATIONS (page I)

Brushed-metal finish BR 0031ST and soft touch matt transparent varnish.

Sablé colors Brem without supplement.

Other BREM colors to quote

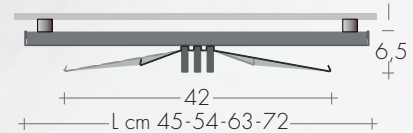

RECOMMENDED VALVES (pag.II)

CHROME VALVES KIT with:

n°2 Valves with tang, n°2 Fittings (multilayer ø16, copper ø12, 14), n°2 wall plates ø 48, hole ø16

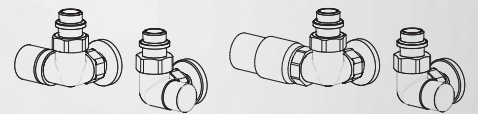

STANDARD FITTING EG ø 1/2"

Tapping centres ▲▼ L - 15 cm

Special fittings page 278



EAGLE 187-54

CYL Valve with THERMOSTATIC Head

EN 442 Watt Δt 50K (Δt 40K = Wx0,755) - (Δt 30K = Wx0,526)

MODEL'25	H cm	L cm	45	54	63	72
		▲▼cm	30	39	48	57
EAGLEH 187	€	2037,80	2175,20	2311,10	2443,70	
		887w	1061w	1233w	1407w	
EAGLELH 187	€	2385,50	2563,30	2727,20	2890,40	
		1181w	1453w	1723w	1996w	
EAGLEH 207	€	2107,20	2241,60	2382,00	2520,90	
		985w	1178w	1369w	1562w	
EAGLELH 207	€	2518,00	2703,80	2867,30	3041,00	
		1313w	1616w	1916w	2219w	
EAGLEH 227	€	2182,70	2344,30	2479,20	2625,70	
		1082w	1294w	1504w	1716w	
EAGLELH 227	€	2586,30	2778,60	2947,70	3126,70	
		1445w	1778w	2109w	2441w	

ELECTRIC VERSION

MODEL'25	H - L	Standard color	KIT RE /KIT RT p.208
⚡	cm	€	Cable R..E/Faston R..T Art. (W) €
E..H 180-45	2037,80	R900II..	255,30
E..H 200-54	2241,60	R1200II..	276,30
E..LH 180-45	2385,50	R1200II..	276,30
E..LH 180-54	2563,30	R1500II..	298,00
Es: EAGLEH 180-45 BR0031ST 2037,80€ + Kit electric R900II.. + Thermostat pag. 208-209			

ON REQUEST (H-7cm, depth f/wall 5,8cm) pag.II

- FITTINGS EG ▲▼ L - 4 cm with visible valves.

- REMOTE FITTINGS con REMOTE Valves p.274

The texture of a square mesh grid shines through under the surface treated with a smoothing of resin-based mixes.

Each piece is hand-made, so unique.

BREM'ART CREATIONS (page I)

Standard "sablé" colors are recommended by the artist.

Other Ral colors in the sablé finish only on request.

RECOMMENDED VALVES (pag.II)

CHROME VALVES KIT with:
n°2 Valves with tang, n°2 Fittings (multilayer ø16, copper ø12, 14), n°2 wall plates ø 48, hole ø16

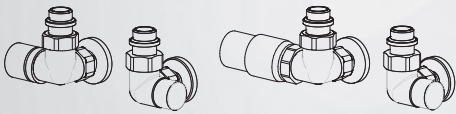

STANDARD FITTING EG ø 1/2"
Topping centres ▲▼ L - 15 cm
Special fittings page 278



GRID 187-45

CYL Valve with THERMOSTATIC Head

ELECTRIC VERSION				EN 442 Watt Δt 50K (Δt 40K = Wx0,755) - (Δt 30K = Wx0,526)						
MODEL'25	Standard	KIT RE/KIT RT p.208	MODEL'25	L cm	36	45	54	63	72	
⚡	H - L	color	Art. (W)	▲▼cm	21	30	39	48	57	
cm	cm	€	Câble R..E/Faston R..T Art. (W) €	H cm	2005,60	2121,80	2242,40	2361,50	2477,30	
G..H 180-36	2005,60	R800II..	240,50	GRIDH 187	713w	887w	1061w	1233w	1407w	
G..H 180-45	2121,80	R900II..	255,30	GRIDLH 187	909w	1181w	1453w	1723w	1996w	
G..H 200-54	2308,80	R1200II..	276,30	GRIDH 207	792w	985w	1178w	1369w	1562w	
G..LH 180-45	2469,50	R1200II..	276,30	GRIDLH 207	1011w	1313w	1616w	1916w	2219w	
G..LH 180-54	2630,50	R1500II..	298,00	GRIDH 227	870w	1082w	1294w	1504w	1716w	
Es: GRID 180-45	2166,60€ +			GRIDLH 227	1112w	1445w	1778w	2109w	2441w	
Kit electric R900II.. + Thermostat	pag. 208-209									

ON REQUEST (H=7cm, depth f/wall 5,8cm) pag.II
- FITTINGS EG ▲▼ L - 4 cm with visible valves.
- REMOTE FITTINGS con REMOTE Valves p.274

BREM colors list page 281

Technical data B'A Panels page II

From the radiant plate a drape is born: it animates the surface evoking sensations of intense and profound life.

The color becomes the protagonist of fascinating shades in whose furrows memories settle.

BREM'ART CREATIONS (page I)

The work is hand painted in the color broom Yellow SB 1032 (standard), Ral reference 1032

On request in the color Pompeii Red SB 3011, Ultramarine Blue SB 5002 or patina Green SB 6000. The color number corresponds to the RAL color list.

Other Ral colors in the sablè finish only on request.



RECOMMENDED VALVES (pag.II)

CHROME VALVES KIT with:
n°2 Valves with tang, n°2 Fittings (multilayer ø16, copper ø12, 14), n°2 wall plates ø 48, hole ø16

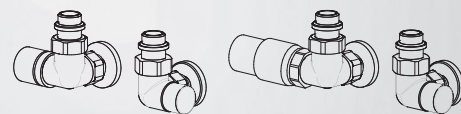

STANDARD FITTING EG ø 1/2"
Tapping centres ▲▼ L - 15 cm
Special fittings page 278



SHANG 187-54

CYL Valve with THERMOSTATIC Head

EN 442 Watt Δt 50K (Δt 40K = Wx0,755) - (Δt 30K = Wx0,526)

MODEL	H cm	L cm	EN 442 Watt Δt 50K (Δt 40K = Wx0,755) - (Δt 30K = Wx0,526)				
			36	45	54	63	72
SGH	187	€	▲ 2184,80	2301,00	2421,60	2540,70	2656,50
			▼ 713w	887w	1061w	1233w	1407w
SGLH	187	€	▲ 2515,40	2648,70	2809,70	2956,80	3103,20
			▼ 909w	1181w	1453w	1723w	1996w
SGH	207	€	▲ 2245,50	2370,40	2488,00	2611,60	2733,70
			▼ 792w	985w	1178w	1369w	1562w
SGLH	207	€	▲ 2624,70	2781,20	2950,20	3096,90	3253,80
			▼ 1011w	1313w	1616w	1916w	2219w
SGH	227	€	▲ 2316,20	2445,90	2590,70	2708,80	2838,50
			▼ 870w	1082w	1294w	1504w	1716w
SGLH	227	€	▲ 2687,20	2849,50	3025,00	3177,30	3339,50
			▼ 1112w	1445w	1778w	2109w	2441w

ELECTRIC VERSION

MODEL	H - L cm	Standard color €	KIT RE /KIT RT p.208	
			Cable R..E/Faston R..T Art. (W) €	€
SGH 180-36	2184,80	2184,80	R800II..	240,50
SGH 180-45	2301,00	2301,00	R900II..	255,30
SGH 200-54	2488,00	2488,00	R1200II..	276,30
SGLH 180-45	2648,70	2648,70	R1200II..	276,30
SGLH 180-54	2809,70	2809,70	R1500II..	298,00
Es:SGH 180-45 SB3011 2301,00€				
+ Kit electric R900II.. + Thermostat pag. 208-209				

ON REQUEST (H-7cm, depth f/wall 5,8cm) pag.II
- FITTINGS EG ▲▼ L - 4 cm with visible valves.
- REMOTE FITTINGS con REMOTE Valves p.274

An imaginary walk on the uneven surface of the moon, the sensation of overcoming space and gravity for the very first time: this is the message that Steven Cavagna gets across by adding softness to a radiator.

BREM'ART CREATIONS (page I)
Standard "sablé" colors recommended.



On request: Model Terra Art. TRH
Only with horizontal textures.
Thermal output and prices like the Terra Lunare.

RECOMMENDED VALVES (pag.II)

CHROME VALVES KIT with:
n°2 Valves with tang, n°2 Fittings (multilayer ø16, copper ø12, 14), n°2 wall plates ø 48, hole ø16

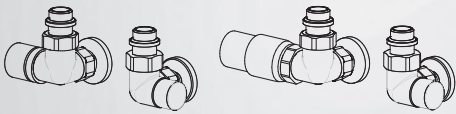

STANDARD FITTING EG ø 1/2"
Tapping centres ▲▽ L- 15 cm
Special fittings page 278



TERRA LUNARE 207-45

CYL Valve with THERMOSTATIC Head

ELECTRIC VERSION

MODEL'25	H - L cm	Standard color €	KIT RE/KIT RT p.208	
			Câble R..E./Faston R..T Art. (W) €	€
TEH	180-36	2162,40	R800II..	240,50
TEH	180-45	2284,20	R900II..	255,30
TEH	200-54	2476,80	R1200II..	276,30
TELH	180-45	2631,90	R1200II..	276,30
TELH	180-54	2798,50	R1500II..	298,00

Es: TEH 180-45 2284,20€ + Kit electric R900II..
+ Thermostat pag. 208-209

ON REQUEST (H-7cm, depth f/wall 5,8cm) pag.II
- FITTINGS EG ▲▽ L- 4 cm with visible valves.
- REMOTE FITTINGS con REMOTE Valves p.274

MODEL'25	H cm	L cm ▲▽cm	EN 442 Watt Δt 50K (Δt 40K = Wx0,755) - (Δt 30K = Wx0,526)				
			36	45	54	63	72
TEH	187	€	2162,40 713w	2284,20 887w	2410,40 1061w	2535,10 1233w	2656,50 1407w
TELH	187	€	2493,00 909w	2631,90 1181w	2798,50 1453w	2951,20 1723w	3103,20 1996w
TEH	207	€	2223,10 792w	2353,60 985w	2476,80 1178w	2606,00 1369w	2733,70 1562w
TELH	207	€	2602,30 1011w	2764,40 1313w	2939,00 1616w	3091,30 1916w	3253,80 2219w
TEH	227	€	2293,80 870w	2429,10 1082w	2579,50 1294w	2703,20 1504w	2838,50 1716w
TELH	227	€	2664,80 1112w	2832,70 1445w	3013,80 1778w	3171,70 2109w	3339,50 2441w

BREM colors list page 281

Technical data B'A Panels page II

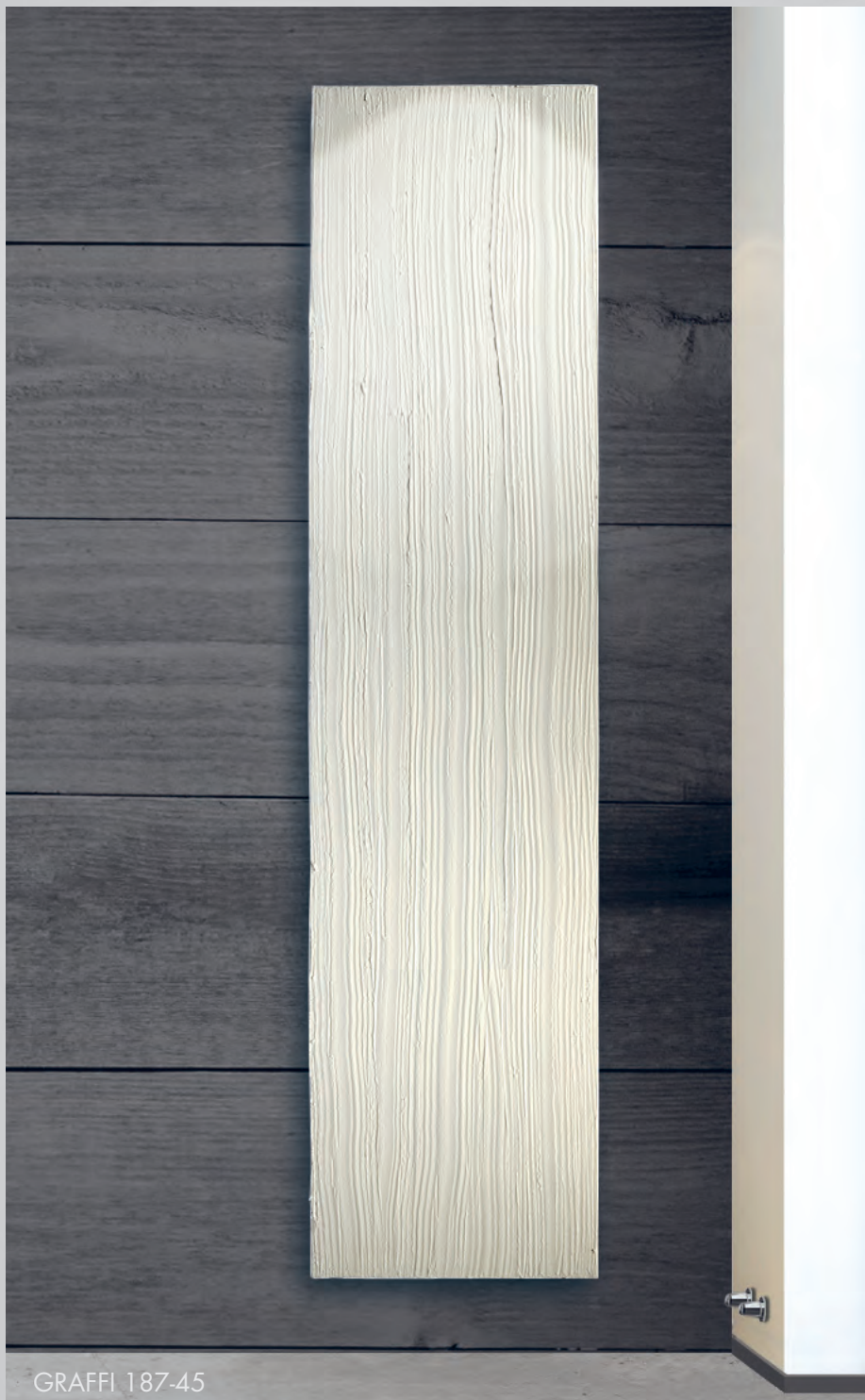

GRAFFI has a merely furrow form surface. This gave birth to a radiator that creates very particular atmosphere, where light and color play an important role. Each piece is hand-made, than unique.

BREM'ART CREATIONS (page I)

Standard "sablé" colors recommended by the artist.

Other Ral colors in the sablé finish only on request.

ESECUZIONI BREM'ART (pag.I)

Colori sablé tabella Brem, consigliati dall'artista.

Altri colori Ral nella sola finitura sablé a preventivo.

Other Ral colors in the sablé finish only on request.

RECOMMENDED VALVES (pag.II)

CHROME VALVES KIT with:
n°2 Valves with tang, n°2 Fittings (multilayer ø16, copper ø12, 14), n°2 wall plates ø 48, hole ø16

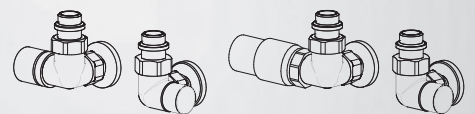

STANDARD FITTING EG ø 1/2"
Tapping centres ▲▼ L - 15 cm
Special fittings page 278



CYL REMOTE Valves

MODEL'25	H cm	L cm	EN 442 Watt Δt 50K (Δt 40K = Wx0,755) - (Δt 30K = Wx0,526)					
			▲▼cm	36	45	54	63	72
GFH	187	€	2005,60	2121,80	2242,40	2361,50	2477,30	
			713w	887w	1061w	1233w	1407w	
GFLH	187	€	2336,20	2469,50	2630,50	2777,60	2924,00	
			909w	1181w	1453w	1723w	1996w	
GFH	207	€	2066,30	2191,20	2308,80	2432,40	2554,50	
			792w	985w	1178w	1369w	1562w	
GFLH	207	€	2445,50	2602,00	2771,00	2917,70	3074,60	
			1011w	1313w	1616w	1916w	2219w	
GFH	227	€	2137,00	2266,70	2411,50	2529,60	2659,30	
			870w	1082w	1294w	1504w	1716w	
GFLH	227	€	2508,00	2670,30	2845,80	2998,10	3160,30	
			1112w	1445w	1778w	2109w	2441w	

BREM colors list page 281

Technical data B'A Panels page II

ELECTRIC VERSION

MODEL'25	H - L cm	Standard color €	KIT RE /KIT RT p.208	
			Cable R..E /Faston R..T Art. (W) €	
GFH	180-36	2005,60	R800II..	240,50
GFH	180-45	2121,80	R900II..	255,30
GFH	200-54	2308,80	R1200II..	276,30
GFLH	180-45	2469,50	R1200II..	276,30
GFLH	180-54	2630,50	R1500II..	298,00

REMOTE FITTINGS (H=7cm) page II
DISTANT Valves page 274



GRAFFI welcomes the moon and becomes GRAFFI DI LUNA, where furrows leave room to a smooth, rising moon.

BREM'ART CREATIONS (page I)

Standard "sablé" colors recommended by the artist, other colors on request.

Other Ral colors in the sablé finish only on request.

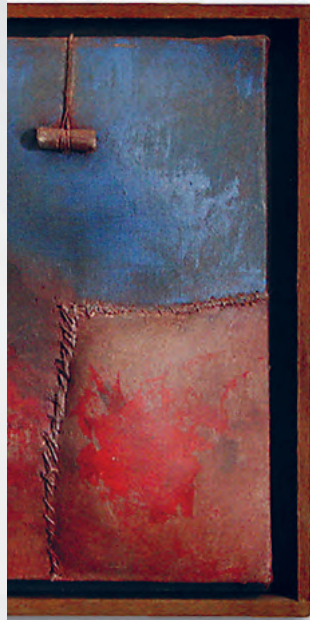

RECOMMENDED VALVES (pag.II)

CHROME VALVES KIT with:

n°2 Valves with tang, n°2 Fittings (multilayer ø16, copper ø12, 14), n°2 wall plates ø 48, hole ø16

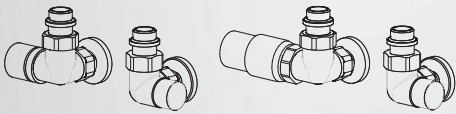

STANDARD FITTING EG ø 1/2"

Tapping centres ▲▼ L- 15 cm

Special fittings page 278



GRAFFI DI LUNA 187-45

CYL Valve with THERMOSTATIC Head

ELECTRIC VERSION

MODEL'25	Standard	KIT RE/KIT RT p.208
H - L	color	Câble R..E/Faston R..T
cm	€	Art. (WV) €
GUH 180-36	2095,20	R800II.. 240,50
GUH 180-45	2217,00	R900II.. 255,30
GUH 200-54	2409,60	R1200II.. 276,30
GULH 180-45	2564,70	R1200II.. 276,30
GULH 180-54	2731,30	R1500II.. 298,00

Es: GUH 180-45 2217,00€ + Kit electric R900II.. + Thermostat pag. 208-209

ON REQUEST (H=7cm, depth f/wall 5,8cm) pag.II

- FITTINGS EG ▲▼ L- 4 cm with visible valves.

- REMOTE FITTINGS con REMOTE Valves p.274

MODEL'25	L cm	36	45	54	63	72
H cm	▲▼cm	32	41	50	59	57
GUH 187 €		2095,20	2217,00	2343,20	2467,90	2589,30
		713w	887w	1061w	1233w	1407w
GULH 187 €		2425,80	2564,70	2731,30	2884,00	3036,00
		909w	1181w	1453w	1723w	1996w
GUH 207 €		2155,90	2286,40	2409,60	2538,80	2666,50
		792w	985w	1178w	1369w	1562w
GULH 207 €		2535,10	2697,20	2871,80	3024,10	3186,60
		1011w	1313w	1616w	1916w	2219w
GUH 227 €		2226,60	2361,90	2512,30	2636,00	2771,30
		870w	1082w	1294w	1504w	1716w
GULH 227 €		2597,60	2765,50	2946,60	3104,50	3272,30
		1112w	1445w	1778w	2109w	2441w

BREM colors list page 281

Technical data B'A Panels page II



PIET 187-45

CYL Valve with THERMOSTATIC Head

The design of this radiator is a tribute to Piet Mondrian and his neoplasticism style, where the artist has manually drawn intersecting vertical and horizontal lines on a material background to create a work of clean geometric rigour.

BREM'ART CREATIONS

Sablé white SB9016 finish, parallelepiped in relief piped and red color.

Other sablé colors Brem without extra

Other Ral colors in the sablé finish only on request.

RECOMMENDED VALVES (pag.11)

CHROME VALVES KIT with:
n°2 Valves with tang, n°2 Fittings (multilayer ø16, copper ø12, 14), n°2 wall plates ø 48, hole ø16

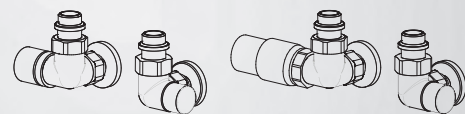

STANDARD FITTING EG ø 1/2"
Tapping centres ▲▼ L - 15 cm
Special fittings page 278



MODEL '25	H cm	L cm	EN 442 Watt Δt 50K (Δt 40K = Wx0,755) - (Δt 30K = Wx0,526)				
			36	45	54	63	72
PIET	187	€	1960,80 713w	2077,00 887w	2208,80 1061w	2327,90 1233w	2443,70 1407w
PIET-L	187	€	2291,40 909w	2424,70 1181w	2596,90 1453w	2744,00 1723w	2890,40 1996w
PIET	207	€	2021,50 792w	2146,40 985w	2275,20 1178w	2398,80 1369w	2520,90 1562w
PIET-L	207	€	2400,70 1011w	2557,20 1313w	2737,40 1616w	2884,10 1916w	3041,00 2219w
PIET	227	€	2092,20 870w	2221,90 1082w	2377,90 1294w	2496,00 1504w	2625,70 1716w
PIET-L	227	€	2463,20 1112w	2625,50 1445w	2812,20 1778w	2964,50 2109w	3126,70 2441w

MODEL'25	H - L cm	Standard color €	ELECTRIC VERSION	
			KIT RE /KIT RT p.208	Art. (W) €
PIET	180-36	1960,80	R800II..	240,50
PIET	180-45	2077,00	R900II..	255,30
PIET	200-54	2275,20	R1200II..	276,30
PIET-L	180-45	2424,70	R1200II..	276,30
PIET-L	180-54	2596,90	R1500II..	298,00
Es: VR2H 180-45 SB9016			2077,00€	
+ Kit electric R900II.. + Thermostat pag. 208-209				

ON REQUEST (H-7cm, depth f/wall 5,8cm) pag.11
- FITTINGS EG ▲▼ L - 4 cm with visible valves.
- REMOTE FITTINGS con REMOTE Valves p.274

VIRGO, with its surface graved by nearly signed furrows, creates a minimal decoration inspired by nature. Splits crack like cuts the surface producing discontinuities and revealing the inner core of the radiator.

Each piece is hand-made, than unique.
Sablé standard colors at choice, satinated colors for the furrows, other colors on request.

BREM'ART CREATIONS

Sablé gray SB9006 finish, parallelepiped in relief gray and red color.

Other sablè colors Brem without extra

Other Ral colors in the sablè finish only on request.



RECOMMENDED VALVES (pag.11)

CHROME VALVES KIT with:
n°2 Valves with tang, n°2 Fittings (multilayer ø16, copper ø12, 14), n°2 wall plates ø 48, hole ø16

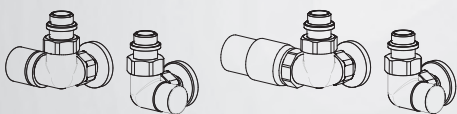

STANDARD FITTING EG ø 1/2"
Tapping centres ▲▼ L- 15 cm
Special fittings page 278



VIRGO 2/187-45

VIRGO 3/187-54

CYL Valve with THERMOSTATIC Option

CYL Valve with THERMOSTATIC Head

ELECTRIC VERSION

MODEL'25	Standard	KIT RE/KIT RT p.208
H - L	color	Câble R..E/Faston R..T
cm	€	Art. (W) €
VR..H 180-36	2105,30	R800II.. 240,50
VR..H 180-45	2223,20	R900II.. 255,30
VR..H 200-54	2721,90	R1200II.. 276,30
VR..LH 180-45	2570,80	R1200II.. 276,30
VR..LH 180-54	2721,90	R1500II.. 298,00

Es: VR2H 180-45 Ral9005-M 2223,20€
+ Kit electric R900II.. + Thermostat pag. 208-209

ON REQUEST (H-7cm, depth f/wall 5,8cm) pag.11
- FITTINGS EG ▲▼ L- 4 cm with visible valves.
- REMOTE FITTINGS con REMOTE Valves p.274

MODEL'25	L cm	36	45	54	63	72
H cm	▲▼cm	21	30	39	48	57
VR..H 187 €		2105,30	2223,20	2333,70	2454,40	2560,70
		713w	887w	1061w	1233w	1407w
VR..LH 187 €		2435,90	2570,80	2721,90	2870,40	3007,30
		909w	1181w	1453w	1723w	1996w
VR..H 207 €		2166,00	2292,50	2400,20	2525,30	2637,80
		792w	985w	1178w	1369w	1562w
VR..LH 207 €		2545,20	2703,30	2862,40	3010,60	3158,00
		1011w	1313w	1616w	1916w	2219w
VR..H 227 €		2236,60	2368,00	2502,90	2622,50	2742,70
		870w	1082w	1294w	1504w	1716w
VR..LH 227 €		2607,70	2771,70	2937,20	3091,00	3243,60
		1112w	1445w	1778w	2109w	2441w

BREM colors list page 281

Technical data B'A Panels page 11

BREM: COLOR LIST

THIS COLORS LIST SHOULD BE USED ONLY AS A GUIDE; CONSULT THE BREM COLORS CARD IN OUR WHOLE SALLERS



SB 9016 Standard white SABLÈ, C-PROLUX model excluded

STANDARD COLORS

See technical page of each model



Ral 9016 standard only C-PROLUX - Other models + 15%

SEMI-GLOSS COLORS

SATIN COLORS

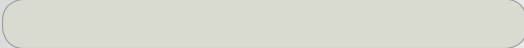

RAL 9002 Grey white

Satin RAL 9002-S

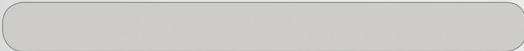

RAL 7047 Grey Chinchilla

Satin RAL 7047-S

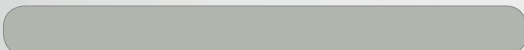

RAL 7044 Silk grey

Satin RAL 7044-S



RAL 7030 Stone grey

Satin RAL 7030-S

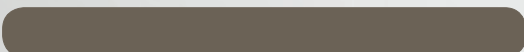

RAL 7006 Grayish beige

Satin RAL 7006-S

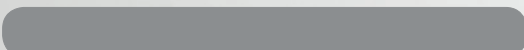

RAL 7036 Platinum grey

Satin RAL 7036-S

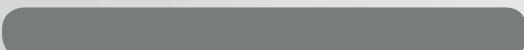

RAL 7037 Dusty grey

Satin RAL 7037-S

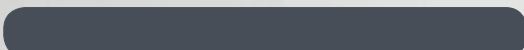

RAL 7015 Slate grey

Satin RAL 7015-S



RAL 5013 Cobalt blue

Satin RAL 5013-S

Selection of RAL colors available in various finishes: semi-gloss, satin, matt and softTOUCH.

SEMI-GLOSS COLORS INCREASE +15% 70-80GU
E.g. Ral 9002

SATIN COLORS INCREASE +15% 50-60 GU
E.g. Ral 9002-S

SoftTOUCH COLORS INCREASE +25% 5-10GU
E.g. Ral 9002-ST
Velveteen and soft touch finish, easy cleaning, fingerprint and abrasion resistant available in all colors.

SEMI-GLOSS COLORS

SATIN COLORS

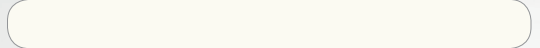

RAL 9010 Pure white

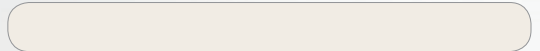

RAL 9001 Cream White

Satin RAL 9001-S



RAL 1013 Oyster white

Satin RAL 1013-S



RAL 1015 Light ivory

Satin RAL 1015-S



RAL 1017 Saffron yellow

Satin RAL 1017-S



RAL 3000 Flame red

Satin RAL 3000-S



RAL 3003 Rubies red

Satin RAL 3003-S



RAL 3011 Brown red

Satin RAL 3011-S

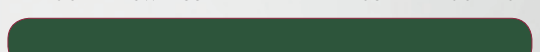

RAL 6000 Green Patina

Satin RAL 6000-S

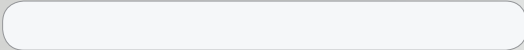

RAL 9016-M White (matt)

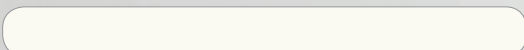

RAL 9010-M Pure white (matt)

MATT COLORS INCREASE +15% 25-35 GU
E.g. Ral 9005-M



RAL 8008-M Olive Brown (matt)



RAL 9005-M Black matt - (Semi-gloss only for some model)

SEMI-GLOSS COLORS

MATT COLORS 10 GU

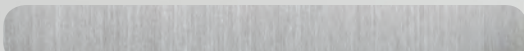

GA05 Brushed NICKEL

Matt GA05-M



GA09 Gunmetal (black grey)

Matt GA09-M

GALVANIC FINISHES

Painting on Herg, Regular and Torri step 80; Panels, Sbarra, Guest, Hergot, Herg's, Kuo, Hook, Cross-V, Alis, Asym, Fit, Essen, Kare, Quar, Vision and models "Tubes Design". Not feasible on Cross lame models and those with overlapping tubes. Request feasibility and quote.

SEMI-GLOSS COLORS

MATT COLORS 10 GU

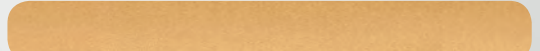

GA19 GOLD

Matt GOLD GA19-M



GA33 BRONZE

Matt BRONZE GA33-M

SPECIAL FINISHES + 35%

- BR 0031 only for panels, Cross, Essen, Quar and Pit, is a brushed-metal effect to hide scratches on the surface, clear varnish. (BR 0007 is the color that both comes closest to natural iron and best conceals imperfections).
- BR 0021 transparent polished finish, it transmits the brass effect, glimpsing weldings.
- SB 0022 BL polished and nuanced rust color finish that perfectly fits with the gilded leaf finishes (Eruzione)
- BR 0022ST sablé rust color shaded.

HIGH-GLOSS COLORS 90 GU



BR 0031 Brushed metal

Matt BR 0031-M

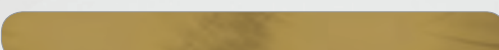

BR 0021 Simil-brass clear

Satin BR 0021-S



BR 0022BL Bright rust (shaded color)

BREM SPECIAL FINISHES (panels excluded)

- BR 0001, a transparent metallic bright finish, highlights the signs of working on iron (welding, scoring, brushing, rings, marks, etc.); the phosphate greasing process enhances the colors of steel in shades of grey, blue, brown, and dark green, and makes each piece unlike any other. This finish is a good example of "Poor Art" and it is not available for the radiating plates.
- BR 0001 MS, a clear matte finish, transmits all the raw material's "brutality", whereas a shiny finish softens the look (not available for radiating plates). These finishes are an expression of "Arte povera".

COLORS FOR ARCHITECTURE: 180 RAL COLORS IN VARIOUS FINISHES
colors out of Brem list: +25%, + cost contribution upon availability and feasibility

METAL COLORS +25%

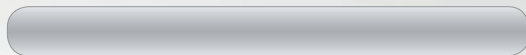

BR 0002 Semi-gloss Aluminium



BR 0006 Semi-gloss Metal aluminium

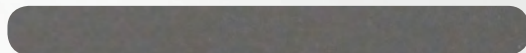

BR 0007 Semi-gloss Metal grey



BR 0008 Semi-gloss Black nickel

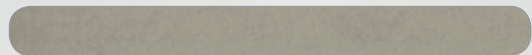

BR 1035 Semi-gloss Pearl beige

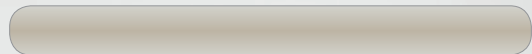

BR 0004 Semi-gloss Gilded aluminium



BR 0019 Semi-gloss Metal gold

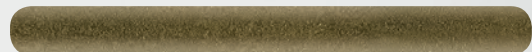

BR 0033 Semi-gloss Metal bronze

METAL SATIN COLORS +25%

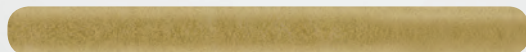

BR 0019-MS Satin metal gold



BR 0033-MS Satin metal bronze



BR 0002-MS Satin aluminium

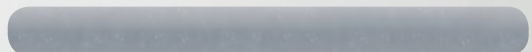

BR 0006-MS Satin metal aluminium



BR 0007-MS Satin metal grey

SABLÉ COLORS +25%

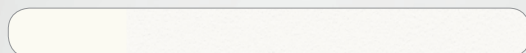

SB 9010 Sablé pure white



SB 7035 Sablé light grey



SB 9006 Sablé aluminium



SB 9007 Sablé grey aluminium

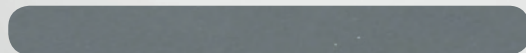

SB 7005 Sablé mouse grey



SB 7039 Sablé quartz grey



SB 7011 Sablé iron grey



SB 9005 Sablé jet black



SB 5002 Sablé ultramarine light blue



SB 2639 Sablé blue

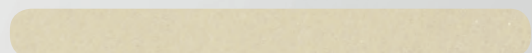

SB 1014 Sablé ivory



SB 370F Sablé beige

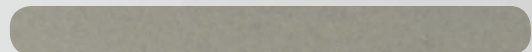

SB 356F Sablé beige turtle



SB 2589 Sablé beige grey

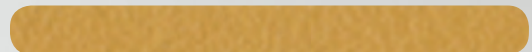

SB 1032 Sablé broom yellow



SB 2008 Sablé oxide orange

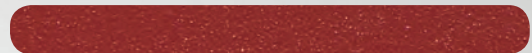

SB 3013 Sablé tomato red



SB 3003 Sablé ruby red



SB 0022 Sablé rust nuanced

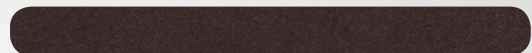

SB 3061 Sablé dark copper

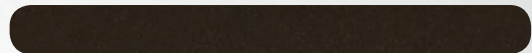

SB 3281 Sablé grey brown

HEAT, SAVE, and DECORATE

HEAT WHILE SAVING MONEY: THE GREAT CHALLENGE IN BUILDING CLIMATE CONTROL. *ENG. FRANCESCO PAOLETTI*

HEATING and SAVING

Everyone, and every designer, systems engineer, builder, and lawmaker is looking for ways to save on energy costs today in order to:

- reduce polluting atmospheric emissions;
- optimize comfort performance;
- lower energy consumption.

The world's two most common heating systems are:

THE RADIATOR SYSTEM,

The classic heating system with a boiler or heat pump and radiators that thanks to rapid heat transmission (**low thermal inertia**) can:

- work with both low and high system water temperatures;
- ensure nearly instantaneous adjustments to temperature variation with user-friendly and inexpensive regulation systems in single rooms or entire areas;
- facilitate installation with lower costs;
- minimize pump electric power consumption.

The low thermal inertia of the radiators makes it easy to keep the room at comfort temperature (20 °C) only when necessary, in this way permitting significant energy savings.

THE UNDERFLOOR RADIANT HEATING SYSTEM

(only with **high thermal inertia**) consists of cross-linked polyethylene or multilayer pipes laid on insulating panel incorporated in the floor's substrate screed and one or more circuits for the area to be heated.

- Floor surface temperature must never exceed 29 °C in the living areas and 35 °C in the service areas.
- Room temperature regulation can be either on/off type with water circulation interruption or delivery water temperature modulation type.
- Temperatures in single rooms/areas are adjusted by motorized valves in every circuit.
- Because the panels cannot ensure adequate comfort, bathrooms are supplied with a heated towel rail with either mixed or electric power.

The heat is initially transmitted to the floor screed and then transferred to the room for heating (**high thermal inertia**) with a substantial delay of usually no less than 6 hours between the request for/interruption of heat emission and the perception of heat in the room, in this way leading to higher energy consumption.

IN SHORT: THE ENERGY NEED DEPENDS ON THE BUILDING.

A BUILDING'S ENERGY REQUIREMENT depends on numerous physical phenomena associated with thermal exchange, heat transmission, and the type and characteristics of the heat generators and heating elements.

The main factors involved in determining the energy required to heat a building are therefore:

- the thermohygrometric characteristics of the building's constructive materials;
- the efficiency of the technological systems;
- auxiliary electric power consumption;
- building/heating system interaction;
- the building's intended use.

Maximum efficiency and sustainability means achieving the maximum level of every parameter involved.

THE BUILDING ENVELOPE

is the most important element in determining the energy required to meet its heating needs. The quantity of heat needed to heat a building and therefore its energy requirement depends solely on its constructive features.

The thermal power that must be provided by the heating system to keep the building at a temperature of 20 °C is always the same regardless of the type of heating system used.

For example:

Energy class	Heated area	Thermal power required
- Class A	100 sq m	4,050 W
- Class G	100 sq m	13,000 W

The thermal power required depends on the building's insulation.

BUILDING/HEATING SYSTEM INTERACTION

The building's intended use affects the heating system's operating modes:

- continuous;
- discontinuous.

For this reason, the heating system must be capable of optimizing its output as required by the operating mode.

Residential buildings, offices and schools are not occupied uninterruptedly and for such reason can be heated discontinuously, which is very useful whenever energy must be saved (current regulations specify heating system operation to different temperatures during the day).

A home's comfort temperature (20 °C) must be constantly maintained only when its inhabitants are at home.

THE DELIVERY OF THE ENERGY NEEDED DEPENDS ON THE HEATING SYSTEM.

HEATING SYSTEM EFFICIENCY

is the heating system's performance in terms of:

- output, which depends on the characteristics of the heat generator;
- distribution, which depends on the characteristics of the hydraulic network;
- emission, which depends on the characteristics of the radiators in the room;
- regulation, which depends on the thermal inertia of the radiators.

- **OUTPUT EFFICIENCY** depends on the characteristics of the heat generator and the heating elements. The combustion efficiency for condensing boilers or the COP (coefficient of performance) for heat pumps depends on the average temperature of the system water. The lower this average temperature is, the higher the efficiency is.

- **COMBUSTION EFFICIENCY** depends on:

- the length of the connection network between the heat generator and the heating bodies (the length of the piping must be kept as short as possible and efficient insulation must be used);
- the average temperature of the water inside the piping and above all, its insulation (low temperature: < 50 °C);
- electrical power consumption (circulation pumps, motorized valves): the higher the consumption, the lower the efficiency.

The use of the following heating elements that operate at low temperature is also advised:

- fan coils;
- radiant panels;
- heating elements/radiators.

Regardless of their constructive material, all radiators are suited operation at both high and low temperature.

- **EMISSION EFFICIENCY** is one characteristic of heating elements. The thermal power delivered is indicated in the manufacturers' catalogs.

- **REGULATION EFFICIENCY** depends on numerous parameters, the most important of which is the heating system's thermal inertia. One positive aspect of radiators is the possibility they offer to take advantage of "bonus" temperature rises (sunshine, mid-seasonal rises, indoor heat, the presence of people, etc.) because their low thermal inertia allows them to immediately interrupt heat delivery (a form of regulation that is scarcely efficient for radiant panel systems).

Low thermal inertia systems follow variations in temperature rapidly (both inside and outside the building) and boast higher regulation efficiency than high thermal inertia systems.

THE PERFORMANCE OBTAINED BY THE EFFICIENCY OF REGULATION OF DELIVERY IS FUNDAMENTAL.

RADIANT PANEL and RADIATOR PERFORMANCE COMPARED

RESEARCH CONDUCTED BY ENG. FRANCESCO PAOLETTI PUBLISHED IN: www.brem.it/riscaldare-risparmiare

RESEARCH AGREEMENT between the "Sergio Stecco" Energy Department at the UNIVERSITY OF FIRENZE and GLOBAL Srl.

The comparison was made in 2 test chambers of identical dimension, constructive type, and energy needs equivalent to an approx. 50-60 sq m Class A building, one with radiant panels and the other radiators, both equipped with a 7.5 kW heat pump. The thermal profile of the two test chambers may be considered reasonably comparable and therefore assumed as representative. The comparison between the energy consumed by the two systems is unconnected to the type of heat source used and is based on the actual heat entering each system.

ANALYSIS OF THE RESULTS

Analyzing the energy charts and consumptions of the two systems shows that under all circumstances and operating modes (continuous/discontinuous):

- the radiant panel heating system consumes more energy than the radiator heating system;
- the electrical power consumptions of the radiant panel systems are always higher than those of the radiator system;
- at equivalent temperature set points, and despite the more refined regulation, the temperature of the room heated by radiant panels tends to be always higher than the other room. In particular, during time-band operation, higher temperatures are observed even with the system switched off, which in practice corresponds to moments in which the building is not occupied and therefore no need for heating exists.

This becomes more evident as outdoor temperatures rise and daily temperature variations increase (in mid-season), a condition typical to most heating system operating hours in most parts of Italy.

Also in the tests conducted with radiator water set at higher temperatures that seriously penalized consumption, significant savings were observed in radiator systems (in demonstration of the fact that the optimization of output efficiency may be all in vain if the emission system is not in the condition to maximize regulation efficiency).

In addition to thermal consumptions being always higher, also the electric consumptions of the radiant panel system were also always higher due to the higher pumping power necessary for the circulation of a higher quantity of water than in the radiator circuit.

The inadequacy and economic disadvantages of radiant panel heating for newly constructed Class A civil buildings characterized by very low heating loads and very low thermal inertia is plainly clear to see.

RESULTS OF FIRST TEST CAMPAIGN

Total energy consumed from 10/02 to 01/05
 Continuous 24 hour operation
 Discontinuous operation with 2 time-bands
 Discontinuous operation with 3 time-bands
 Radiant panel on/off regulation
 Radiator on/off regulation
 Radiant panel average delivery temperature: 40 °C
 Heat pump set-point temperature: 45 °C
 Radiant panel active energy: 861,898 kW
 Radiator active energy: 638,999 kW

RADIANT PANEL ENERGY CONSUMPTION +34.9%

Days	Energy Consumption Panels	Energy Consumption Radiators	DIFFERENCE Panel-Radiator
16/2 to 20/2	87,4 kWh	79,0 kWh	+ 10,6%
24/2 to 3/03	115,9 kWh	82,9 kWh	+39,8%
19/3 to 8/04	221,7 kWh	178,2 kWh	+24,4%

RESULTS OF SECOND TEST CAMPAIGN

Total energy consumed from 23/11 to 15/04
 Continuous 24 hour operation
 Discontinuous operation with 3 time-bands
 Radiant panel on/off regulation
 Radiator on/off regulation
 Radiant panel average delivery temperature: 35 °C
 Heat pump set-point temperature: 40 °C
 Radiant panel active energy: 1.756,700 kW
 Radiator active energy: 1.591,400 kW

RADIANT PANEL CONSUMPTION +10.4%

The second test campaign was conducted with a structure oriented at optimizing the radiant panel system (continuous operation at low temperature) while feeding radiators with water at higher temperatures at the same time (a choice that penalizes heat pump efficiency and consumption)

THE ENERGY CONSUMPTIONS OF THE RADIANT PANEL system exceeded those of the RADIATOR system by 10 - 40%

COMPARISON OF THE PERFORMANCES OF THE TWO SYSTEMS

The data selection criteria permitted the identification of the five days that may be considered representative of the different conditions of operation of the two systems in question.

Radiant panel systems clearly show higher thermal consumptions than radiator systems with differences in the range of 4 - 44% on the typical test days considered.

The differences are minimal under continuous operation but increase significantly with time-band operation, in this way confirming the tendency of radiant panels to operate continuously due to their high thermal inertia.

The thermal consumptions of each of the two systems were obtained from the differences in water delivery and return temperatures and the ambient temperature after electrical absorption values were detracted

The results showed the radiator system to have less thermal consumption, varying from 5% under continuous operation (optimum for radiant panels) to 40% for highly discontinuous operation.

The difference between the electric power consumptions and the thermal consumptions of the two systems gradually increased as the warmer months approached in which reduced requests for heat increased the incidence of the heating circulators.

- In all tests, the average temperature of the room with radiant panels was observed to be higher than the room with radiators due to the higher thermal inertia of the radiant panels.
- This explains also why the radiant panel system generally consumes more energy than radiators during hours in which operation is discontinuous.

The table provides total thermal and electric power consumptions in the 24 hours of the five typical days

TYPICAL DAY	Tot. Thermal Consumption		DIFFERENCE Thermal consumption Panel-Radiator	Electric Power Consumption		DIFFERENCE electric consumption Panel-Radiator
	PANELS kWh	RADIATORS kWh		PANELS kWh	RADIATORS kWh	
1	41,5	39,7	+ 4,5%	17,1	15,2	+12,5%
2	33,1	26,5	+24,9%	15,0	10,3	+45,6%
3	19,3	16,7	+15,6%	10,2	9,2	+10,9%
4	17,7	9,9	+78,8%	9,6	7,2	+33,3%
5	13,6	11,6	+17,2%	8,5	3,6	+ 236%

THE USER CAN ASSESS HOW MUCH SAVING CAN BE MADE USING THE RADIATOR HEATING SYSTEM IN DISCONTINUOUS OPERATION

The absence of radiators occupying wall space is proposed as an advantage offered by floor heating, which makes no visual impact of its own, but choosing attractive radiators with original shapes built expressly for the spaces available can enable authentic interior architecture that can be personalized by color or rendered nearly invisible by matching the finishing given to the walls

Making the right decision to heat your home is a choice of fundamental importance: the highly vaunted economic advantages of the radiant panel system have been proven to be untrue. The possibility to switch heating on and off quickly and suddenly (the one and only real saving in energy) is still the most appropriate solution today.

GENERAL SALE CONDITIONS

PRICE LIST n°25 - FROM 1 MAY 2025 - VAT EXCLUDED

ORDERS

The selling of BREM products DDU UK retailers according to INCOTERMS 2000, is ruled by the general conditions hereafter listed. Further changes will be valid only if confirmed by us in writing.

The order confirmation must be checked when received, if, within 2 calendar days, further information does not follow, the confirmation is considered valid to start manufacturing.

BREM reserves the right to add modifications to the dimensions and to effect differentiated deliveries for goods in the warehouse and goods in manufacturing.

The technical specifications concerning the BREM radiators, which involve the tolerance of use, must be considered as approximate and subject to variations.

ORDER MODIFICATIONS

Variations and cancellations of orders are subject to our written approval.

The costs already met will be debited to the buyer. Orders with a fixed-time confirmation can be cancelled or modified only within the delivery term.

The possible modifications, subject to the BREM written approval, to be made on radiators in manufacturing, involve an additional charge of 40-70% of the cost of the radiator; if the required modifications are not possible, the radiator will be completed as standard and debited as the order confirmation.

DELIVERY

All goods shall be delivered, upon the terms in the confirmation of order that indicates the loading date, by means of BREM's handing over the goods to the shipper who is then responsible for actual delivery of the goods. Should the reseller fail to pick up the delivered goods, the Company reserves the right to debit the reseller the cost and liability of storage and the materials shall be invoiced as normal. BREM s.r.l. reserves the right to choose the packaging type; special packing materials shall be invoiced separately.

If there is a delay in delivery of the goods by BREM for technical reasons or reasons involving product quality, the reseller may not refuse delivery or collection of the goods ordered.

308

CLAIMS AND RETURNS

Claims for damage due to transport or lost goods must be pointed out on signing the delivery note with reservation for the received goods, and informing BREM s.r.l. in writing within two days.

Claims for visible manufacturing faults must be communicated at the moment of the unpacking and before mounting the radiator.

No return will be accepted without our written approval. Damaged radiators or with manufacturing defects must be returned to the company for suitable repairs as these are made-to-measure goods.

PAYMENT

Unless otherwise agreed, all invoices shall be paid within 30 days, in full and without further discounting.

All delivered goods remain the property of BREM until full payment is made; in the event of non-payment, Brem s.r.l. reserves the right to withdraw any unpaid goods.

TOLERANCES

Brem radiators are built with great care: the machining and welding at up to 1085° may cause expansion and stretching (tolerance \pm 3mm)

GUARANTEE

BREM radiators are guaranteed for three years, beginning from the delivery day, provided that they have been used in the appropriate way and the installation has been performed correctly.

All accessories are guaranteed for two year. Any components that are found to have manufacturing or material defects within the warranty period shall be repaired free of charge upon request (in writing), ex your works, without making any changes to the structure or color.

All returns (defective materials) shall be packed and sent to our production site using our courier, after obtaining our written authorization to do so.

Any transport damages due to inadequate packaging will be charged.

The guarantee does not cover products which have not been paid for and products which have been damaged by:

- unsuitable storage of radiators without the plastic packaging and/or in humid locations
- incorrect installation and use;
- incorrect maintenance: cleaning with aggressive detergents can ruin the surface; clean the surface using a damp cloth and polish it with car wax;
- installation carried out by unqualified personnel
- repairs carried out without written permission from BREM s.r.l.;
- addition of aggressive chemical products in the heating system water;
- periodical emptying of the heating system;
- connection to heating systems with an open expansion tank, or to water treatment equipment or to overloaded systems;
- operating pressures higher than those in the technical specifications;
- connection to sanitary water apparatus.
- using hemp on fittings supplied with an O-ring

APPLICABLE LAW

For all unforeseen issues and in case of dispute, the applicable law to each supply is Italian law (Court of Bergamo, Italy).

COMPETENT COURT

In the event of a dispute, the sole jurisdiction of the Court of Bergamo (ITALY) is expressly recognized.



BREM
RADIATORS FOR ARCHITECTURE

