



# BREMI

CALORIFERI PER L'ARCHITETTURA

LISTINO PREZZI  
N°25  
MADE IN ITALY  ITALIAN LIFESTYLE

AUMENTO LISTINO PREZZI  
01.03.2026 +5%

**INDEX CATALOGO N°25**

COLLEZIONE LAME	pag.	9
LAME	pag.	10
LAME-UP	pag.	12
HERG	pag.	14
META	pag.	16
REGULAR	pag.	22
SBARRA SBARRA-UP	pag.	24
TORRI	pag.	26
scaldasalviette GUEST	pag.	28
HERG-OT	pag.	30
HERG'S	pag.	32
HOOK	pag.	34
KUO	pag.	36
LAMATH	pag.	38
LAME SLIM	pag.	40
COLLEZIONE CrossFRAME	pag.	43
CROSS-Q	pag.	44
CROSS-G	pag.	46
CROSS-V	pag.	50
ALIS-ONE	pag.	52
ASYMM ASYMP	pag.	54
CROSS	pag.	56
CROSS-Q	pag.	60
CROSS F. ORO/FA	pag.	62
CROSS Bicolor Tric	pag.	62
CROSS-CROM	pag.	63
CROSS-R	pag.	66
CROSS-RV	pag.	68
ESSEN	pag.	70
FIT	pag.	72
FREE	pag.	74
KORE PLUS	pag.	76
PIT	pag.	78
QUAR	pag.	80
VISION	pag.	82
COLLEZIONE PIASTRE	pag.	85
CLAK	pag.	86
C-PROLUX®	pag.	90
EGON	pag.	94
LAMINA	pag.	98
OPEN	pag.	102
PHUL	pag.	106
SO-FLEX	pag.	108
S-PLATT	pag.	110
SUIT	pag.	114
CAMEO	pag.	120
CLARK	pag.	122
CUBICO	pag.	124
DUO	pag.	126
FLAG	pag.	128
GEOMETRICA-T GEO-O	pag.	130
GEOMETRICA-Q GEO-R	pag.	132
HOT	pag.	134
LOGGIA Design/Timeless	pag.	136
MANT	pag.	138
PLATT COLOR	pag.	140
PLATT INOX	pag.	142
PLATT FO/FA	pag.	143
UNI-PLATT	pag.	144
VELETTA	pag.	146
COLLEZIONE TubiDESIGN	pag.	149
CHEM	pag.	150
FORM	pag.	152
GRATA	pag.	156
RING	pag.	160
WIND	pag.	164
CANNUCCIA	pag.	168
CHEM-M	pag.	170
CHEM-S	pag.	172
FRAC	pag.	174
KUAD	pag.	176
MAHN	pag.	178
MAHN-AIR	pag.	180
PLANK	pag.	182
PLANK-AIR	pag.	184
PLUS 12	pag.	186
PLUS 18	pag.	188
PLUS-AIR	pag.	190
RAW verticale	pag.	192
RAW orizzontale	pag.	194
SHAR	pag.	196
SHAR-AIR	pag.	198
START START CURVO	pag.	200
DIVIS scaldasalviette divisori	pag.	202
COLLEZIONE Elettrici	pag.	205
COLLEZIONE Valvole	pag.	265
SISTEMA WiFi Avanzato	pag.	275
COLLEZIONE BREM'ART dopo	pag.	280
CONDIZIONI DI VENDITA	pag.	308

**INDEX ALFABETICO**

ALIS-ONE	pag.	52
ASYMM ASYMP	pag.	54
C-PROLUX®	pag.	90
CAMEO	pag.	120
CANNUCCIA	pag.	168
CHEM	pag.	150
CHEM-M	pag.	170
CHEM-S	pag.	172
CLAK	pag.	86
CLARK	pag.	122
CROSS	pag.	56
CROSS Bicolor Tricolor	pag.	62
CROSS-CROM	pag.	63
CROSS F. ORO/FA	pag.	62
CROSS-G	pag.	46
CROSS-Q radiatore	pag.	144
CROSS-Q scaldasalviette	pag.	60
CROSS-R	pag.	66
CROSS-RV	pag.	68
CROSS-V	pag.	50
CUBICO	pag.	124
DIVIS scaldasalviette divisori	pag.	202
DUO	pag.	126
EGON	pag.	94
ESSEN	pag.	70
FIT	pag.	72
FLAG	pag.	128
FORM	pag.	152
FRAC	pag.	174
FREE	pag.	74
GEOMETRICA-T GEO-O	pag.	130
GEOMETRICA-Q GEO-R	pag.	132
GRATA	pag.	156
GUEST	pag.	28
HERG	pag.	14
HERG-OT	pag.	30
HERG'S	pag.	32
HOOK	pag.	34
HOT	pag.	134
KORE PLUS	pag.	76
KUAD	pag.	176
KUO	pag.	36
LAMATH	pag.	38
LAME	pag.	10
LAME SLIM	pag.	40
LAME-UP	pag.	12
LAMINA	pag.	98
LOGGIA Design/Timeless	pag.	136
MAHN	pag.	78
MAHN-AIR	pag.	180
MANT	pag.	138
META	pag.	16
OPEN	pag.	102
PHUL	pag.	106
PIT	pag.	78
PLANK	pag.	182
PLANK-AIR	pag.	184
PLATT COLOR	pag.	140
PLATT F. ORO/FA	pag.	143
PLATT INOX	pag.	142
PLUS 12	pag.	186
PLUS 18	pag.	188
PLUS-AIR	pag.	190
QUAR	pag.	80
RAW verticale	pag.	192
RAW orizzontale	pag.	194
REGULAR	pag.	22
RING	pag.	160
S-PLATT	pag.	110
SBARRA SBARRA-UP	pag.	24
SHAR	pag.	196
SHAR-AIR	pag.	198
SO-FLEX	pag.	108
START START CURVO	pag.	200
SUIT	pag.	114
TORRI	pag.	26
UNI-PLATT	pag.	44
VELETTA	pag.	146
VISION	pag.	82
WIND	pag.	164
ZOOM	pag.	263

COLLEZIONE ELETTRICI	pag.	205
TERMOSTATI - WiFi	pag.	208
e.ALIS	pag.	210
e.ASYMM e.ASYMP	pag.	211
e.CAMEO	pag.	212
e.CANNUCCIA	pag.	213
e.CHEM e.CHEM-M	pag.	214
e.CHEM-S	pag.	215
e.CLAK	pag.	216
e.CLARK	pag.	217
e.CROSS	pag.	218
e.CROSS-CROM ..FO/FA	pag.	219
e.CROSS-G	pag.	220
e.CROSS-Q	pag.	221
e.CROSS-R	pag.	222
e.CROSS-V	pag.	220
e.CUBICO	pag.	223
e.DUO	pag.	224
e.ESSEN	pag.	225
e.FIT	pag.	226
e.FLAG	pag.	227
e.FRAC	pag.	228
e.FREE	pag.	229
e.GEOMETRICA-T ..O	pag.	230
e.GEOMETRICA-Q ..R	pag.	231
e.GUEST	pag.	232
e.HAND	pag.	233
e.HERG-OT	pag.	234
e.HERG'S e.HERG	pag.	235
e.HOOK	pag.	236
e.KORE PLUS	pag.	237
e.KUAD	pag.	238
e.KUO	pag.	239
e.LAMATH	pag.	240
e.LAME	pag.	241
e.LAME SLIM	pag.	242
e.LAME-UP	pag.	243
e.MAHN	pag.	244
e.MAHN-AIR	pag.	245
e.MANT	pag.	246
e.PHUL	pag.	247
e.PIT	pag.	248
e.PLANK e.PLANK-AIR	pag.	249
e.PLATT	pag.	250
e.PLUS 12	pag.	251
e.PLUS 18 e.PLUS-AIR	pag.	252
e.QUAR	pag.	253
e.RAW	pag.	254
e.REGULAR	pag.	255
e.SBARRA e.SBARRA-UP	pag.	256
e.SHAR	pag.	257
e.SHAR-AIR	pag.	258
e.START e.START CURVO	pag.	259
e.UniPLATT	pag.	260
e.VELETTA	pag.	261
e.VISION	pag.	262
e.ZOOM	pag.	263
COLLEZIONE BREM'ART dopo	pag.	280
BACCU MANDARA	pag.	V
CAPITONNÉ	pag.	VI
CIRCO D'IDEE	pag.	XI
CONTINUUM TRE SIPAR W	pag.	VIII
EAGLE	pag.	XVI
ERUZIONE	pag.	IX
FILU&FERRU	pag.	IV
FIRE	pag.	XIV
GRAFFI	pag.	XX
GRAFFI DI LUNA	pag.	XXI
GRID	pag.	XVII
MUN	pag.	VII
NOSTOS	pag.	XIII
PIET	pag.	XXII
PINAK HOT	pag.	XV
SCUDO DI ERACLE	pag.	XII
SHANG	pag.	XVIII
SPAZIO CHIUSO	pag.	III
STROP'	pag.	X
TERRA LUNARE TERRA	pag.	XIX
VIRGO	pag.	XXIII

# LE COLLEZIONI

pag.

LAME  
CALORIFERI AD ELEMENTI



9

CrossFRAME  
CALORIFERI A CORNICI

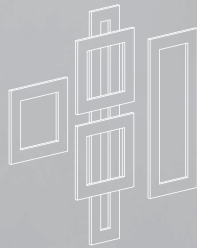

43

PIASTRE  
CALORIFERI A TUBI PIATTI



85

TubiDESIGN  
CALORIFERI A TUBI



149

Modelli ELETTRICI CALORIFERI & SCALDASALVIETTE

205

Valvole&Accessori

265

BREM'ART  
CALORIFERI DI ARTISTI



I - XXIV dopo 280

# BREM. INNOVAZIONE E TRADIZIONE

REALIZZAZIONI NATE DA RICERCA, SPERIMENTAZIONE E DESIGN NEL RISPETTO DELLA TRADIZIONE

BREM È LAVORO DELL'UOMO:

NON SOLO MACCHINE E TECNOLOGIA,  
MA MAESTRANZE QUALIFICATE CAPACI DI  
REALIZZARE I PROGETTI PIÙ IMPEGNATIVI,  
PREPARATE PER TRASFORMARE L'ACCIAIO  
IN PRODOTTI AL MASSIMO DELLA QUALITÀ  
E DALL'ELEVATO VALORE ESTETICO.

BREM: LE COLLEZIONI 2024

- 24 MODELLI DI CALORIFERI
- 55 MODELLI DI SCALDASALVIETTE
- 3 MODELLI CROMATI
- 100.000 DIMENSIONI DI SERIE
- 60 MODELLI ELETTRICI
- BREM'ART: CALORIFERI D'ARTE
- VALVOLE, ACCESSORI E SUPPORTI

## I PUNTI DI FORZA

Brem, specializzata nella progettazione e produzione di caloriferi e scaldasalviette realizzati con tubi d'acciaio, si colloca nella fascia alta del mercato per l'elevato livello qualitativo, per l'originalità estetica e per notevoli pregi distintivi.

### QUALITÀ DEI MATERIALI

Acciaio di alta qualità prodotto secondo le rigide normative internazionali;  
lavorazioni impeccabili di alta precisione;  
saldature sicure ed invisibili;  
verniciatura brillante, luminosa e omogenea.

### DESIGN

Collettori dalla forma ricercata;  
tubi radianti sottili piatti;  
tubi sagomati dalla forma esclusiva;  
mensole regolabili integrate al calorifero.

### FUNZIONALITÀ

Le innumerevoli possibili esecuzioni (alte, strette, lunghe, larghe, piatte...ecc.), previste di serie, consentono l'inserimento ottimale del corpo scaldante nello spazio disponibile.

### GAMMA

Collezione completa composta da 24 modelli di caloriferi e da 55 modelli di scaldasalviette per consentire la scelta estetica più appropriata all'ambiente.

### ESECUZIONI SPECIALI SU MISURA

L'elevata flessibilità produttiva e il processo costruttivo dei caloriferi consentono di rispondere alle richieste più particolari con applicazioni pressochè infinite.

## LE CARATTERISTICHE

Tutti i prodotti Brem, nell'ambito di elevati contenuti estetici, rispondono alle esigenze di comfort abitativo, economicità e praticità di gestione, facilità di installazione.

### PESO RIDOTTO

Peso ridotto fino a 1/3 rispetto ai tubolari tradizionali e fino a 1/8 rispetto ai radiatori in ghisa grazie ai tubi sottili; facilitati anche trasporto e installazione.

### BASSO CONTENUTO D'ACQUA

Riduzione fino a 1/3 della quantità d'acqua rispetto ai radiatori tradizionali.

### RISCALDAMENTO ISTANTANEO

Temperatura programmata raggiunta rapidamente grazie all'acciaio impiegato e alla veloce circolazione della poca acqua contenuta.

### AMBIENTE CONFORTEVOLE

Arresto immediato dell'emissione del calore con l'uso di termostati per ottenere un ambiente più confortevole a temperatura costante.

### RISPARMIO DI ENERGIA

Riduzione dei consumi energetici (conseguente al minor volume d'acqua da scaldare) per raggiungere l'emissione ottimale del calore.

### CALDO CONFORTEVOLE

Il calore si diffonde per irraggiamento e per convezione. La sensazione di benessere è determinata dall'alta percentuale di calore irradiato.

## I VANTAGGI

I caloriferi Brem, a seconda dei modelli, consentono:

- installazioni più razionali e libere da vincoli per ottenere una distribuzione uniforme del calore;
- grande superficie radiante per aumentare la quantità di calore trasmesso per irraggiamento e creare un ambiente più confortevole;
- superiore protezione alle pareti fredde e miglior moto convettivo ascensionale grazie alla maggior superficie sul retro;
- soluzioni originali, che grazie al loro design possono essere installati in ambienti di qualsiasi stile;
- di adattare il radiatore allo spazio disponibile posizionandolo anche a tutta altezza, a fianco di aperture, per meglio contrastare le dispersioni;
- di utilizzare in modo ottimale anche lo spazio sotto la finestra, o alla base di vetrate.

BREM, con piedini e supporti, svincola i caloriferi dalla tradizionale posizione a muro e li fa vivere in libertà, consentendone la collocazione negli ambienti in modo creativo, tra cui:

- divisorio da parete o da centro stanza
- parapetto di scale o di balconate
- ad angolo con due o più caloriferi
- ad arco in verticale sulla parete
- curvo o in tutte quelle forme creative tecnicamente realizzabili.

# INFORMAZIONI TECNICHE

## DATI TECNICI

Legenda simboli

H	altezza
L	lunghezza
p	profondità
▲▽	interasse attacchi (int.att.)
PE	passo elementi
A	superficie
V	volume
M	peso a vuoto
Q <sub>n</sub>	potenza calorifica nominale
Q	potenza calorifica
S	superficie d'irraggiamento
n	esponente
ck	fattore di correzione per Q <sub>n</sub>
m	portata
RE	Resistenza Elettrica

Unità	
cm	
cm	
mm	
mm	
mm	
m <sup>2</sup>	
dm <sup>3</sup>	
kg	
W	
W	
W	
S	
-	
-	
kg/s	
W	

## COEFFICIENTI DI TRASFORMAZIONE

1 W = 0,86 kcal / h  
1 kcal / h = 1,16 W

## RESE TERMICHE NOMINALI Q<sub>n</sub>

Resa calorica nominale in Watt Δt<sup>n</sup> = 50 K  
Secondo la nuova normativa EN 442 la resa termica di un calorifero è rilevata con:

t <sub>1</sub>	temperatura entrata	75°C
t <sub>2</sub>	temperatura uscita	65°C
t <sub>m</sub>	temperatura media dell'acqua	70°C
t <sub>r</sub>	temperatura di riferimento dell'aria	20°C
K	salto termico	10 K
Δt	differenza temperatura acqua-aria	50 K
Δt diverso da 50 K	Q = Q <sub>n</sub> (Δt / 50) <sup>n</sup>	

## FATTORI DI CORREZIONE (Δt diverso da 50 K)

Δt \ n	1,20	1,22	1,24	1,26	1,28	1,30
30k	0,542	0,536	0,530	0,526	0,520	0,514
40k	0,766	0,762	0,759	0,755	0,751	0,748
50k	1	1	1	1	1	1
60k	1,245	1,248	1,253	1,258	1,263	1,267
70k	1,498	1,507	1,518	1,527	1,538	1,549

## TEMPERATURA AMBIENTE diversa da 20°

Per aumentare o diminuire la temperatura di un locale applicare alle rese riportate nel catalogo i seguenti coefficienti teorici:

temperatura	24°C	22°C	20°C	18°C	15°C	12°C
moltiplicatore	0,81	0,90	1,00	1,04	1,10	1,17

Per realizzare gli attacchi senza calorifero è sufficiente aiutarsi con una dima di legno

su cui riportare la misura dell'interasse attacchi.

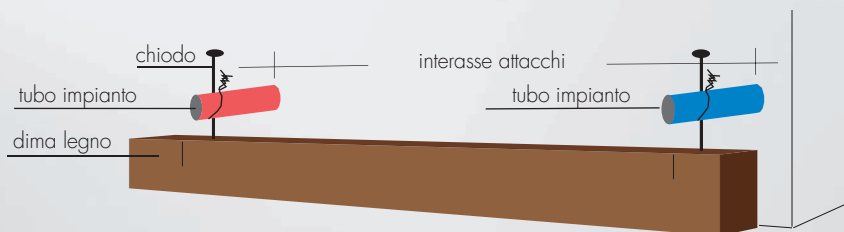

## ESECUZIONE ATTACCHI CALORIFERI

I caloriferi Brem sono forniti di serie con attacchi ø 3/8" e ø 1/2".

Nel particolare di ogni modello è riportata la formula per ricavare l'interasse degli attacchi. (es. mod FH: int. attacchi = Largh. - 4 cm)

Nella sostituzione di vecchi modelli verificare che i nuovi attacchi non vengano realizzati con collegamenti "a sifone"

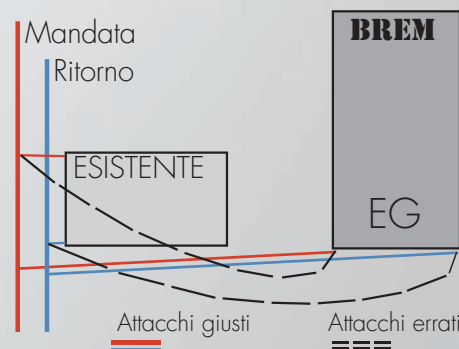

## ALTEZZE CONSIGLIATE PER L'INSTALLAZIONE

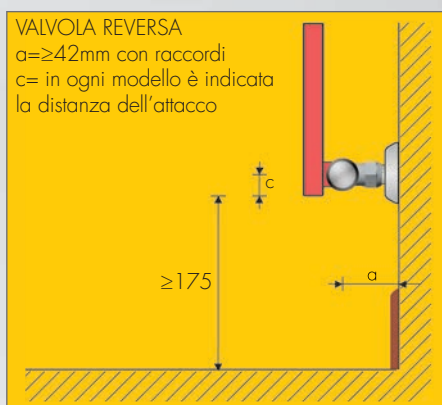
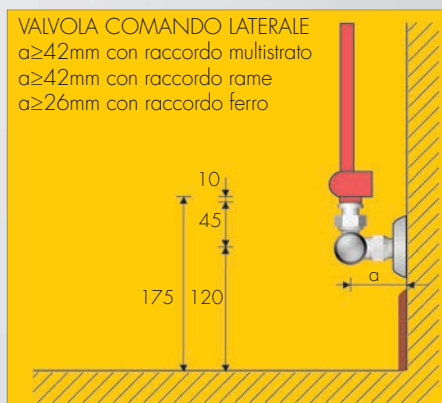
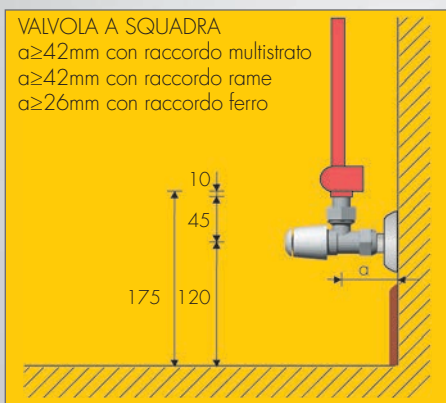

## INSTALLAZIONE E FUNZIONAMENTO

Il collegamento all'impianto dei caloriferi BREM deve rispettare la posizione della mandata e del ritorno con cui sono stati costruiti.

Se l'attacco ordinato è EG, la mandata dovrà essere in basso a sinistra; se la mandata sarà invertita nella posizione G (in basso a destra), il calorifero non si scaldereà completamente.

L'impianto con una pressione di 1,5/1,8 bar fa funzionare i caloriferi in modo uniforme.

La mancanza di pressione nell'impianto non fa circolare l'acqua calda in modo uniforme ed il calorifero non si scaldereà completamente.

Verificare la pressione negli impianti a colonna in particolare dei condomini.

Sfiatare completamente l'aria del radiatore.

Bilanciare l'impianto chiudendo parzialmente l'uscita dell'acqua del detentore.

L'impianto deve essere realizzato senza che i tubi subiscano strozzature.

# INDEX: CALORIFERI

Collezione LAME

LAME p.10  
e.LAME p.241

LAME-UP p.12  
e.LAME-UP p.243

HERG p.14  
e.HERG p.235

META p.16

REGULAR p.22  
e.REGULAR p.255

SBARRA p.24  
SBARRA-UP p.24  
e. SBARRA p.256

TORRI p.26

Collezione CrossFRAME



CROSS-Q p.44  
e.CROSS-Q p.221

CROSS-G p.46  
e. CROSS-G p.220

CROSS-V p.50  
e.CROSS-V p.220

ALIS-ONE p.52  
e.ALIS-ONE p.210



CROSS p.56  
e.CROSS p.218



CROSS-Q p.60  
e.CROSS-Q p.221



ASYM p.54  
e.ASYM p.211



ASYMP p.54  
e.ASYMP p.211



CROSS-R p.66  
e.CROSS-R p.222



Collezione PIASTRE

CLAK p.86  
e.CLAK p.216



EGON p.94



OPEN p.102



SO-FLEX p.108



C-Prolux® p.90



LAMINA p.98



PHUL p.106  
e.PHUL p.247



S-PLATT p.110



SUIT p.114



CAMEO p.120  
e.CAMEO p.212



CUBICO p.124  
e.CUBICO p.223



CLARK p.122  
e.CLARK p.217



DUO p.126  
e.DUO p.224



Collezione TubiDESIGN

CHEM p.150  
e.CHEM p.214



GRATA p.156



WIND p.164



FORM p.152



RING p.160



CANNUCCIA p.168  
e.CANNUCCIA p.213



CHEM-M p.170  
e.CHEM-M p.214



FRAC p.174  
e.FRAC p.228



CHEM-S p.172  
e.CHEM-S p.215



KUAD p.176  
e.KUAD p.238



## Caloriferi ELETTRICI

pag. 205-263



**BREM'ART**

pag. I - XXIV dopo pag.264

VALVOLE

VALVOLE  
pag.265



ACCESSORI  
pag.276



RAM p.277



# SCALDASALVIETTE



GUEST p.28  
e.GUEST p.232

Herg-ÖT p.30  
e.Herg-ÖT p.234

Herg'S p.32  
e.Herg'S p.235

HOOK p.34  
e.HOOK p.236

KUO p.36  
e.KUO p.239

LAMATH p.38  
e.LAMATH p.240

Lame SLIM p.40  
e.Lame SLIM p.242



CROSS-RV p.68



FIT p.72  
e.FIT p.226



Kore PLUS p.76  
e.Kore PLUS p.237



VISION p.82  
e.VISION p.262



ESSEN p.70  
e.ESSEN p.225

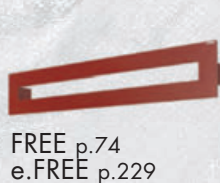

FREE p.74  
e.FREE p.229

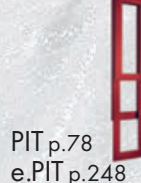

PIT p.78  
e.PIT p.248



QUAR p.80  
e.QUAR p.253



e.ZOOM p.263



FLAG p.128  
e.FLAG p.227



GEO-T p.130  
e.GEO-T p.230



GEO-Q p.132  
e.GEO-Q p.231



HOT p.134



MANT p.138  
e.MANT p.244



Uni-PLATT p.144  
e. Uni-PLATT p.260



GEO-O p.130  
e.GEO-O p.230



GEO-R p.132  
e.GEO-R p.231



LOGGIA p.136



PLATT p.140  
e.PLATT p.250



VELETTA p.146  
e.VELETTA p.261

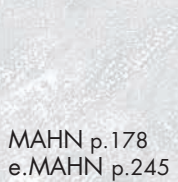

MAHN p.178  
e.MAHN p.245



PLANK p.182  
e.PLANK p.249



PLUS 12 p.186  
e.PLUS 12 p.251



PLUS-AIR p.190  
e.PLUS-AIR p.252



SHAR p.196  
e.SHAR p.257



START p.200  
e.START p.259



Mahn-AIR p.180  
e.Mahn-AIR p.246



Plank-AIR p.184  
e.Plank-AIR p.249



PLUS 18 p.188  
e.PLUS 18 p.252



RAW p.192, 194  
e.RAW p.254



SHAR-AIR p.198  
e.SHAR-AIR p.258



Kuad Shar Start  
DIVIS p.202

HAND p.233



Scaldasalviette  
**ELETTRICI**  
pag. 205-263

MAGNET p.277

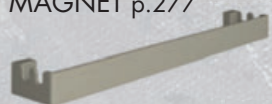

APPENDINI  
pag 277



ESECUZIONI  
SPECIALI pag.276

TERMOREGOLAZIONI  
Wi-Fi pag.275

ATTACCHI  
pag.278-279

**BREM'ART**

pag. I - XXIV dopo pag. 264

# LE COLLEZIONI

pag.

LAME  
CALORIFERI AD ELEMENTI



9

CrossFRAME  
CALORIFERI A CORNICI

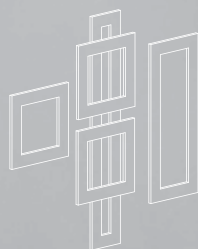

43

PIASTRE  
CALORIFERI A TUBI PIATTI



85

TubiDESIGN  
CALORIFERI A TUBI

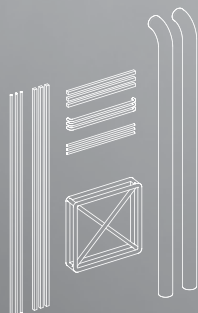

149

Modelli ELETTRICI CALORIFERI & SCALDASALVIETTE

205

Valvole & Accessori

265

BREM'ART  
CALORIFERI DI ARTISTI



I - XXIV dopo 264

# INDEX LAME

CALORIFERI AD ELEMENTI

## COLLEZIONE CALORIFERI

	pag.
LAME	10
LAME-UP	12
HERG	14
META	16
REGULAR	22
SBARRA ..	24
TORRI	26

## COLLEZIONE SCALDASALVIETTE

	pag.
GUEST	28
HERG-OT	30
HERG'S	32
HOOK	34
KUO	36
LAMATH	38
LAME SLIM	40



design Davide Brembilla

LAME è composto da tubi rettangolari uniti da tubi tondi. Gli elementi del calorifero

tagliano l'aria come lame, si accostano l'un l'altro nello spazio in modo vario e leggero

per costruire una nuova forma scaldante che dà vita a una moderna scultura d'arredo.

## DIMENSIONI

Altezze: 190 / 210 / 230 cm

Larghezze: 11 / 17 / 23 / 29 / 35 / 41 / 47 cm

Profondità: 8 cm

Sporgenza dal muro: 9,5 cm

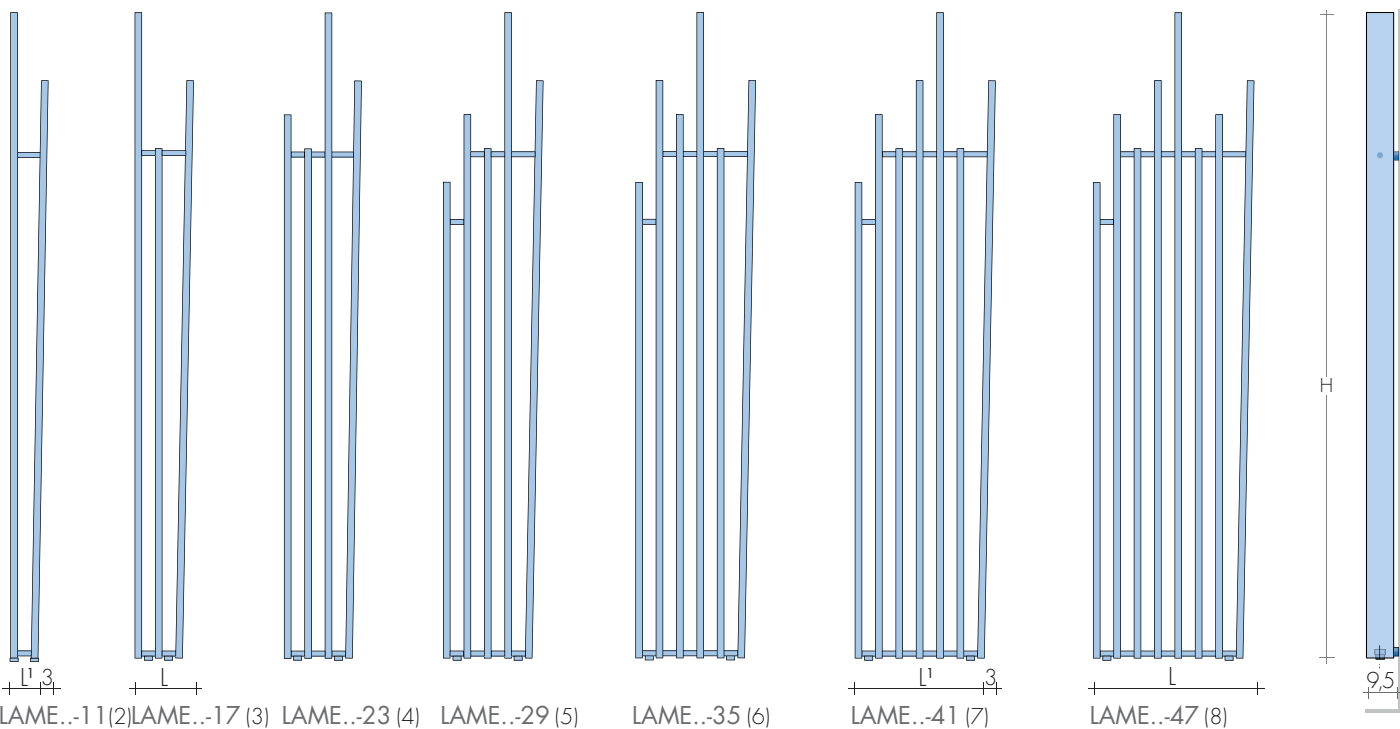

MODELLO	L cm. (n°el.)	EN 442 Watt $\Delta t$ 50K ( $\Delta t$ 40K = $W \times 0,755$ ) ( $\Delta t$ 30K = $W \times 0,526$ )						VERSIONI MISTE con			
		11 (2)	17 (3)	23 (4)	29 (5)	35 (6)	41 (7)	47 (8)	Resistenza e manicotto		
H cm	L1 cm	8	14	20	26	32	38	44	Modello	Watt	€
LAME 190	▲▽ cm	6	6	12	18	24	30	36	LAME 190-2	400	117,20
	€	558,00	686,10	814,10	942,20	1070,10	1198,10	1326,00	LAME 190-3	500	119,30
LAME 210	€	389w	496w	652w	788w	953w	1109w	1255w	LAME 190-4	650	121,30
	€	591,00	735,80	986,20	1025,50	1170,20	1314,80	1459,60	LAME 190-5	800	125,70
LAME 230	€	389w	554w	730w	885w	1070w	1245w	1411w	LAME 190-6	900	129,00
	€	622,40	782,60	1055,60	1102,30	1263,60	1422,10	1580,50	LAME 210-7	1200	136,70
		428w	613w	807w	982w	1187w	1381w	1566w	LAME 210-8	1500	146,90

▶ Pronta consegna

A richiesta altri modelli  
Termostati p.208-209

Esempio: LAME 210-35, EG  $\varnothing$  1/2", SB3061

## ESECUZIONI DI SERIE

Colore bianco sablé SB9016 mensola B15  
Tolleranze  $\pm$  3mm - Valvola di sfianto  $\varnothing$  1/8"  
PRESSIONE MASSIMA D'ESERCIZIO 4 BAR

## ESECUZIONI A RICHIESTA

Verniciatura in una tinta della tabella colori  
Brem con fissaggi B15 colorati +15/25%  
Versione elettrica e.Lame pag.241

## ATTACCHI DI SERIE

EG  $\varnothing$  1/2"  
A richiesta attacchi  $\varnothing$  3/8"  
Attacchi speciali, pag.278



INTERASSE ATTACCHI

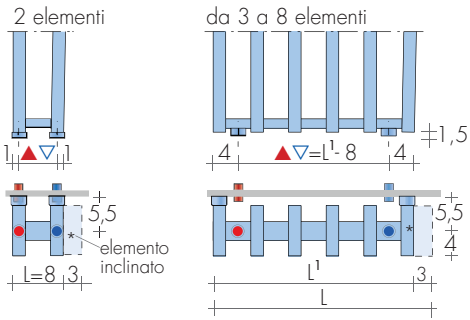

VERSIONI MISTE

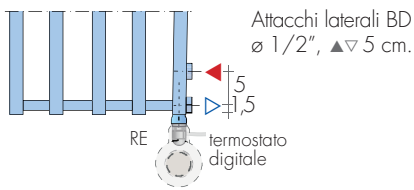

FISSAGGI

Mensole B15 comprese, B27 con attacchi remoti e B35 Lame ...-11

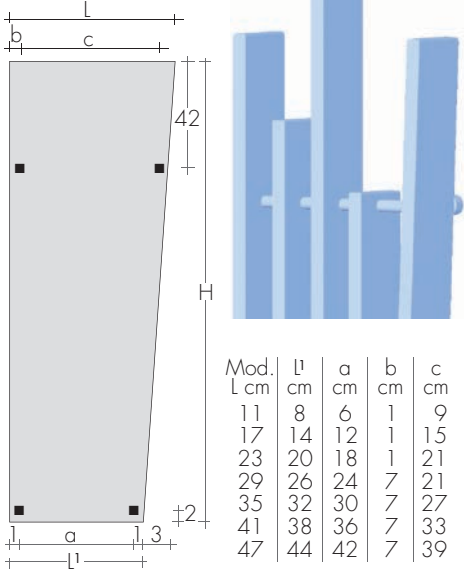

LAME 210-6

VALVOLE CONSIGLIATE

KIT VALVOLE CROMATE comprende:

- n°2 Valvole con codoli
- n°2 Raccordi (per multistrato ø16 e rame ø12 e 14)
- n°2 Rosette tonde cromo ø 48, foro ø16

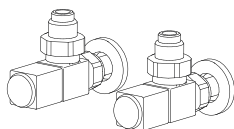

KIT VALVOLE QUADRA a SQUADRA pag.271 Art. KQS 166,80€  
Colore tabella BREM supplemento 49,50€

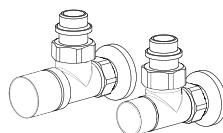

KIT VALVOLE CYL termostattabile a SQUADRA pag.273 Art. KCS 138,80€  
Colore tabella BREM supplemento 49,50€

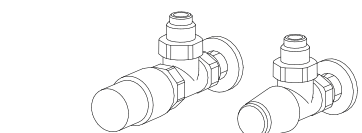
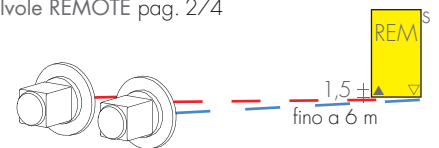

KIT VALVOLE TON a SQUADRA con Testa TERMOSTATICA, pag.269 Art. KTS 176,20€

FINITURE SPECIALI

pag. 267  
Finiture Oro, Bronzo, Nickel spazzolato per 2 valvole  
KIT Raccordi NICKEL spazz. suppl.Art. RN 28,20€

ATTACCHI REMOTI

Art. REM 37,60€  
Interasse attacchi sul retro: ▲▽ EG  
Valvole REMOTE pag. 274

REM

LAME-UP è un radiatore da appoggio, il cui corpo scaldante, collocabile a parete

o a centro stanza, si trasforma in una torre scultorea. Le lame, strutturate con un anda-

mento verticale, definiscono una impostazione volumetrica nuova, versatile e funzionale.

design Davide Brembilla

## DIMENSIONI

Altezza da terra: 200 / 230 cm

Larghezza: 15 cm

Profondità: 19 / 23 / 27 / 31 cm

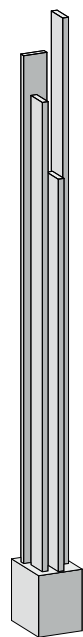

LAME-UP 4

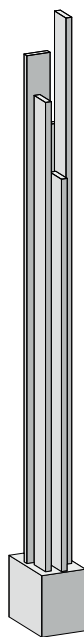

LAME-UP 5

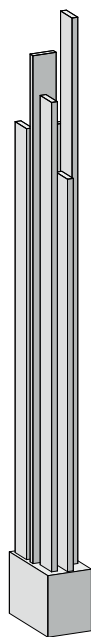

LAME-UP 6

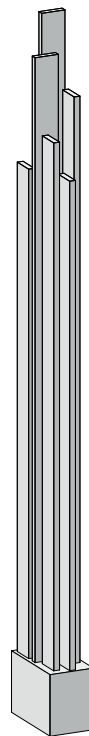

LAME-UP 7

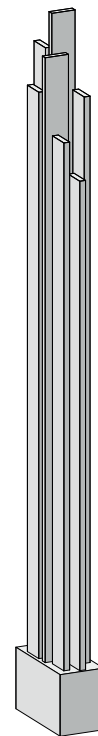

LAME-UP 8

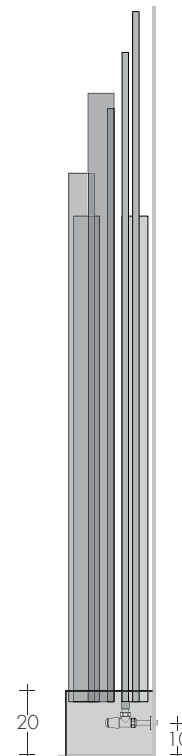

MODELLO	H - n° cm tubi	Bianco di serie sablé SB9016 €	EN 442			▲ ▽ int.att. cm	Altezza cm	Larghezza cm	Profondità cm	Peso M Kg	Volume V dm³	VERSIONI MISTE con: Resistenza e manicotto Watt €	
			Δt 50 K watt	Δt 40 K watt	Δt 30 K watt								
LAME-UP 200-4	200-4	922,00	641	473	333	9	200	15	19	18,9	8,0	650	121,30
LAME-UP 200-5	200-5	1142,00	809	597	421	9	200	15	23	23,7	10,1	800	125,70
LAME-UP 200-6	200-6	1294,50	935	690	486	9	200	15	27	27,3	11,7	900	129,00
LAME-UP 200-7	200-7	1469,00	1082	799	563	9	200	15	27	31,5	13,5	-	-
LAME-UP 200-8	200-8	1663,10	1250	923	650	9	200	15	31	36,3	15,6	1200	136,70
LAME-UP 230-4	230-4	999,30	767	566	399	9	230	15	19	22,5	9,6	800	125,70
LAME-UP 230-5	230-5	1233,20	966	713	502	9	230	15	23	28,2	12,0	900	129,00
LAME-UP 230-6	230-6	1403,90	1124	830	584	9	230	15	27	32,7	14,0	1200	136,70
LAME-UP 230-7	230-7	1591,50	1302	961	677	9	230	15	27	37,8	16,2	1200	136,70
LAME-UP 230-8	230-8	1794,60	1502	1108	781	9	230	15	31	43,5	18,7	1500	146,90

EN 442 Watt Δt 50K (Δt 40K = Wx0,755 - Δt 30K = Wx0,526)

► Pronta consegna Δt diversi da 50K: consultare Dati tecnici Brem

Termostati p.208-209

## POSIZIONAMENTO CENTRO STANZA

Attacchi a pavimento (i.a. ▲ ▽ 9 cm)

es. LAME-UP 200-4, EG ø 1/2", SB9005

Supplemento Art. Lame-UPC 122,20€

## ESECUZIONI DI SERIE

Colore bianco sablé SB9016

Tolleranze ± 3mm - Valvola di sfianto ø 1/8"

PRESSIONE MASSIMA D'ESERCIZIO 4 BAR

## ESECUZIONI A RICHIESTA

Verniciatura in una tinta Brem +15/25%

n.1 faretto LED 1 W Art. F.LED1 58,00€

n.2 faretto LED 1 W Art. F.LED2 96,60€

## ATTACCHI DI SERIE

EG ø 1/2"

Versione elettrica e.Lame-UP pag. 243



INTERASSE ATTACCHI ▲▽ = 9 cm

Posizionamento di serie sul lato corto

Posizionamento su lato lungo Art. LAME-UPL 64,70€ (supplemento)

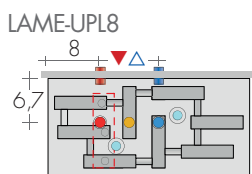
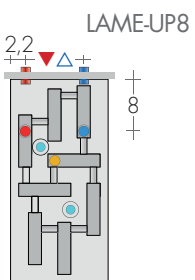
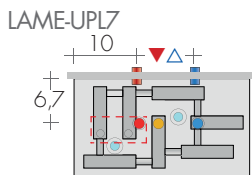
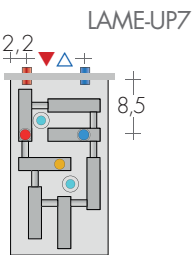
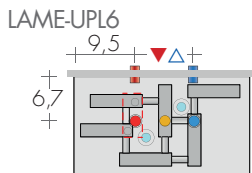
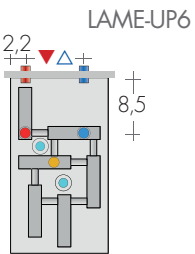
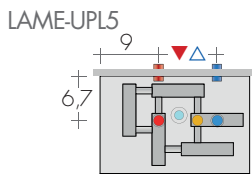
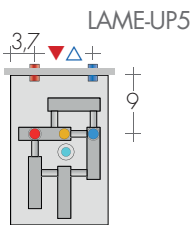
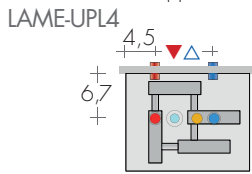
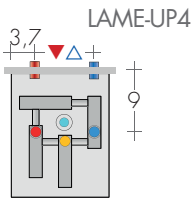

- Mandata
- Ritorno
- Resistenza elettrica
- LED a richiesta



LAME-UP 200-4

VALVOLE CONSIGLIATE

KIT VALVOLE CROMATE comprende:

- n°2 Valvole con codoli
- n°2 Raccordi (per multistrato ø16 e rame ø12 e 14)
- n°2 Rosette tonde cromo ø 48, foro ø16

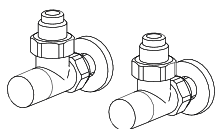

KIT VALVOLE MINI A SQUADRA pag. 270 Art. KMS

114,80€

POSIZIONAMENTO A PARETE con valvole a squadra



POSIZIONAMENTO IN CENTRO STANZA Art. LAME-UPC con valvole diritte



design Luigi Brebbia

HERG è caratterizzato da lame in acciaio parallele che appoggiano a terra e svettano

al soffitto, distanziate con passo 50 o 80 mm. Protagonista è il tubo rettangolare di grandi

dimensioni che disposto in ritmi regolari varia le rese caloriche secondo il passo e l'altezza.

## DIMENSIONI

H: (HG/HGB): 177/197/217/237/257 cm

(HGS): 180/200/220/240 cm

L: da 17 a 98 cm

Profondità: 12 cm

### PASSO 50 (PE50)



### PASSO 80 (PE80)

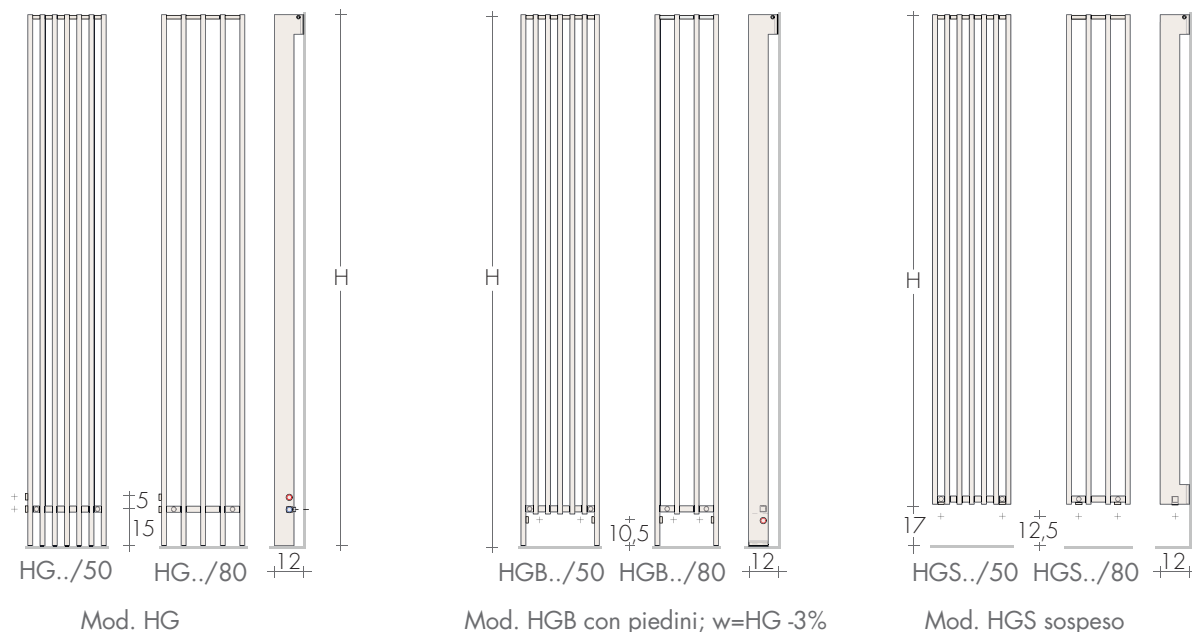

MOD'25	n°elementi passo mm	4		5		6		7		8		9		10		11		12		13	
		/50	/80	/50	/80	/50	/80	/50	/80	/50	/80	/50	/80	/50	/80	/50	/80	/50	/80	/50	/80
HG..177/..	L cm	17	26	22	34	27	42	32	50	37	58	42	66	47	74	52	82	57	90	62	98
	€	706,20	804,50	902,90	1001,20	1099,50	1197,80	1296,10	1394,30	1492,60	1591,00	1689,30	1787,60	1885,90	1984,20	2082,50	2180,80	2279,10	2377,40	2475,70	2574,00
	w	540	638	675	798	810	957	945	1117	1080	1276	1215	1436	1350	1595	1485	1755	1620	1914	1755	2074
HG..197/..	€	737,40	839,60	941,70	1044,00	1146,20	1248,50	1350,50	1452,80	1554,90	1657,00	1759,10	1861,20	1963,30	2065,40	2167,50	2269,60	2371,70	2473,80	2575,90	2678,00
	w	601	710	751	888	901	1065	1020	1240	1352	1598	1502	1775	1652	1953	1802	2130	1953	2308	2152	2542
HG..217/..	€	768,60	874,80	980,60	1086,80	1192,90	1299,00	1405,00	1511,00	1617,10	1723,30	1829,40	1935,50	2041,60	2147,70	2253,80	2359,90	2466,00	2572,10	2678,20	2784,30
	w	662	782	828	978	993	1173	1159	1369	1324	1564	1490	1760	1655	1955	1821	2151	1986	2346	2152	2542
HG..237/..	€	799,70	909,70	1019,70	1129,60	1239,50	1349,50	1459,40	1569,40	1679,30	1789,30	1899,30	2009,30	2119,30	2229,30	2339,30	2449,30	2559,30	2669,30	2779,30	2889,30
	w	723	854	904	1068	1084	1282	1265	1495	1446	1709	1626	1922	1807	2136	1988	2350	2168	2563	2349	2777
HG..257/..	€	831,00	944,80	1058,60	1172,30	1286,30	1400,10	1513,90	1627,70	1741,50	1855,30	1969,10	2082,90	2196,70	2310,50	2424,30	2538,10	2651,90	2765,70	2879,50	2993,30
	w	784	926	980	1158	1176	1390	1372	1621	1568	1853	1764	2084	1960	2316	2156	2548	2352	2779	2548	3011
HGS 180/..	€	760,20	872,00	983,90	1095,70	1207,50	1319,30	1431,10	1542,80	1654,60	1766,50	1878,30	1990,10	2101,90	2213,70	2325,50	2437,30	2549,10	2660,90	2772,70	2884,50
	w	574	678	717	847	860	1016	1004	1186	1147	1355	1291	1525	1434	1694	1577	1863	1721	2033	1864	2202
HGS 200/..	€	791,40	907,10	1022,70	1138,50	1254,20	1370,00	1485,50	1601,30	1716,90	1832,50	1948,10	2063,70	2179,30	2294,90	2410,50	2526,10	2641,70	2757,30	2872,90	2988,50
	w	634	750	793	937	952	1124	1110	1312	1269	1499	1427	1687	1586	1874	1745	2061	1903	2249	2062	2436
HGS 220/..	€	822,60	942,30	1061,60	1181,30	1300,90	1420,50	1540,00	1659,50	1779,10	1898,80	2018,40	2138,00	2257,60	2377,20	2496,80	2616,40	2736,00	2855,60	2975,20	3094,80
	w	696	822	870	1028	1043	1233	1217	1439	1391	1644	1565	1850	1739	2055	1913	2261	2087	2466	2261	2672
HGS 240/..	€	853,70	977,20	1100,70	1224,10	1347,50	1471,00	1594,40	1717,90	1841,30	1964,80	2088,30	2211,80	2335,30	2458,80	2582,30	2705,80	2829,30	2952,80	3076,30	3199,80
	w	756	894	946	1118	1135	1341	1324	1565	1513	1788	1702	2012	1891	2235	2080	2459	2269	2682	2458	2906

Altezze intermedie, ogni 10 cm, per interpolazione, altezze diverse o inferiori, a preventivo.

Δt diversi da 50K: consultare Dati tecnici Brem



Mod. HG

Es: HG 197/50 - 5el AC 1/2"



Mod. HGB

Es: HGB 197/80 - 5el REG 1/2"



Mod. HGS

Es: HGS 180/50 - 10el EG 1/2"

## ESECUZIONI DI SERIE

Colore bianco sablé SB9016

Tolleranze ± 3mm - Valvola di sfiato ø 1/8"

PRESSIONE MASSIMA D'ESERCIZIO 4 BAR

## ESECUZIONI A RICHIESTA

Verniciatura in una tinta della tabella colori

Brem (con fissaggi colorati) +15/25%

Versione elettrica mod. e.HGS pag.235

## ATTACCHI DI SERIE

AC ø 1/2", a richiesta BD

Mod. HGB: REG ø 1/2"

Mod. HGS: EG ø 1/2"



INTERASSE ATTACCHI MOD. HG

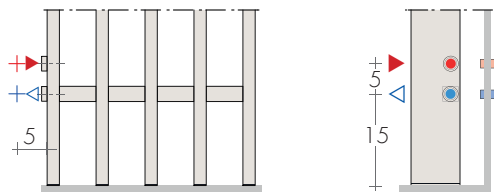

Attacchi laterali di serie in AC ▲▽= 5 cm a richiesta, BD (destra) senza supplemento pag.278

INTERASSE ATTACCHI MOD. HGB

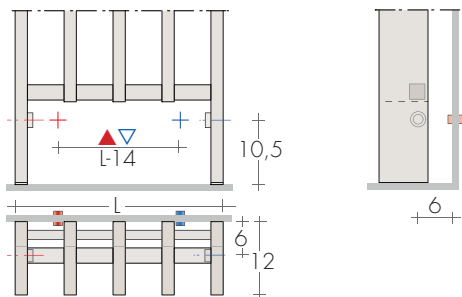

Attacchi REG, da L > di 21 cm, valvole a squadra; da L > di 30 cm valvole a squadra o reverse Mod. HGB ..-4el.(L=17cm) solo attacchi AC

INTERASSE ATTACCHI MOD. HGS

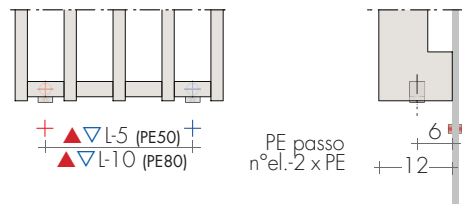

PE passo n°el.-2 x PE

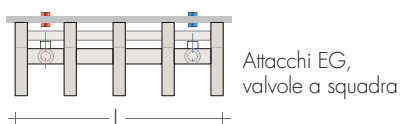

Attacchi EG, valvole a squadra

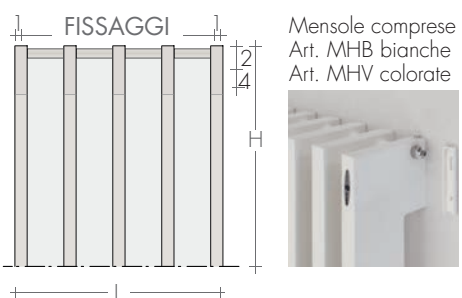

FISSAGGI

Mensole comprese Art. MHB bianche Art. MHV colorate

VALVOLE CONSIGLIATE

KIT VALVOLE CROMATE comprende:

- n°2 Valvole con codoli
- n°2 Raccordi (per multistrato ø16 e rame ø12 e 14)
- n°2 Rosette tonde cromo ø 48, foro ø16

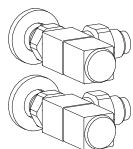

KIT VALVOLE QUADRA a SQUADRA

pag. 271 Art. KQS 166,80€  
Colore tabella BREM supplemento 49,50€

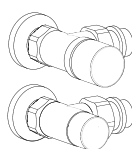

KIT VALVOLE CYL termostattabile a SQUADRA

pag.273 Art. KCS 138,80€  
Colore tabella BREM supplemento 49,50€

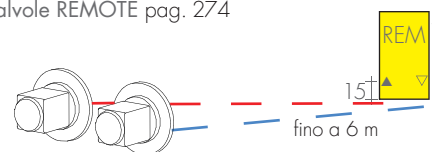

ATTACCHI REMOTI Art. REM 37,60€

Interasse attacchi sul retro: ▲▽ EG

Valvole REMOTE pag. 274

FINITURE SPECIALI

pag. 267

Finiture Oro, Bronzo, Nickel spazzolato per 2 valvole

KIT Raccordi NICKEL spazz. suppl.Art. RN 28,20€

HERG HG 237-5el

META é costruito con le colonne saldate al collettore ad un passo PE (passo elementi)

variabile ogni 5 mm, da 30 a 70 mm. Il corpo scaldante può essere composto con

colonne di profondità 50 o 70 mm ed in versione con colonne semplici o doppie.

## DIMENSIONI

Larghezze: da 10,5 cm a 6m

Altezze: da 21 a 220 cm

Profondità: M1000: 8,2/10,2 cm  
M2000: 12,9/16,9 cm

Sporgenza dal muro: M1000: 11,5/13,5 cm  
M2000: 15,5/19,5 cm

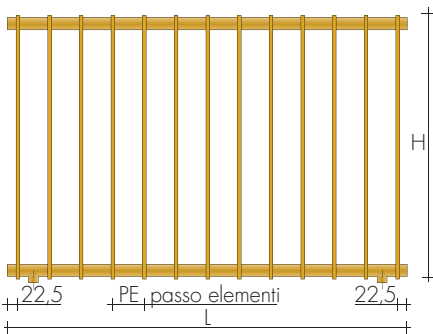

MODELLO M..1000  
con una colonna

M5  
1000

M7  
1000

MODELLO M..2000  
con doppia colonna

M5  
2000

M7  
2000

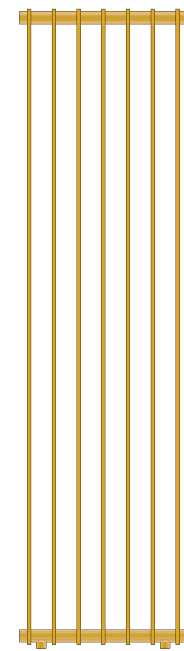
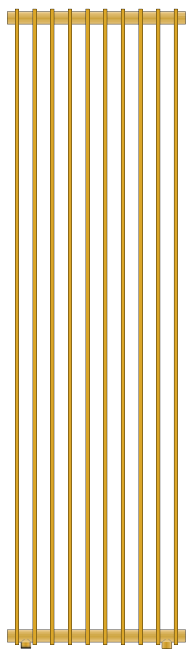

Larghezze: da 3 elementi a 6 m

$L = (n^{\circ} \text{ elementi} - 1) \times PE \text{ (passo)} + 45 \text{ mm}$

PE: passo tra gli elementi:

30 - 35 - 40 - 45 - 50 - 55 - 60 - 65 - 70 mm

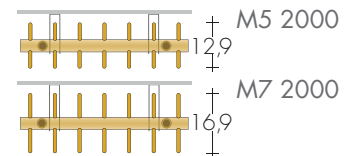
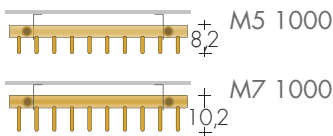

## ESECUZIONI DI SERIE

Colore bianco sablé SB9016 mensole bianche  
Tolleranze  $\pm 3\text{mm}$  - Valvola di sfianto  $\varnothing 1/8''$   
PRESSIONE MASSIMA D'ESERCIZIO 6 BAR

## ESECUZIONI A RICHIESTA

Verniciatura in una tinta della tabella colori  
Brem con fissaggi colorati +15/25%  
Esecuzioni speciali a richiesta, H max 220 cm

## ALLACCIAMENTO DI SERIE

EG  $\varnothing 1/2''$   
Attacchi speciali pag.278



**INTERASSE ATTACCHI**

MODELLO M..1000 con una colonna  
 Attacchi di serie EG ø1/2"

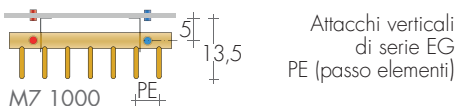
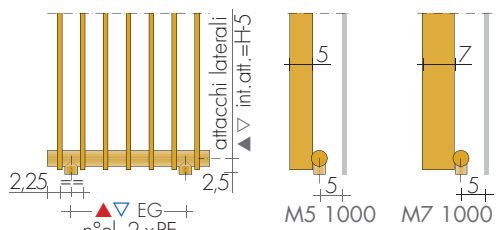

MODELLO M..2000 con doppia colonna  
 Attacchi di serie EG ø1/2"

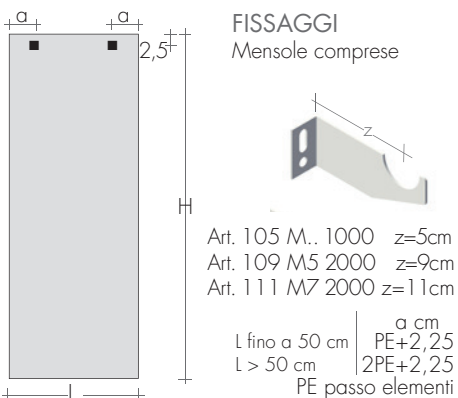
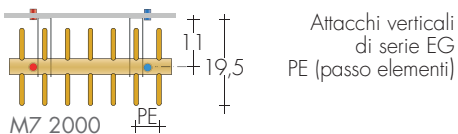
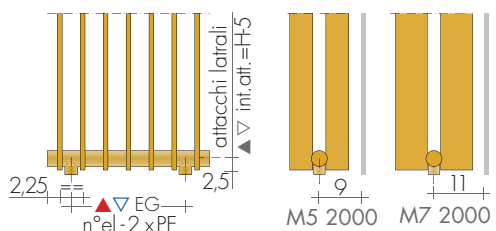

META M5 1220/50-10 el

**VALVOLE CONSIGLIATE**

KIT VALVOLE CROMATE comprende:

- n°2 Valvole con codoli
- n°2 Raccordi (per multistrato ø16 e rame ø12 e 14)
- n°2 Rosette tonde cromo ø 48, foro ø16

**FINITURE SPECIALI**

pag. 267  
 Finiture Oro, Bronzo, Nickel spazzolato per 2 valvole  
 KIT Raccordi NICKEL spazz. suppl.Art. RN 28,20€

**PIEDINO FISSO**

I piedini META sono costruiti con il tubo dell'elemento e saldati allo stesso (H=15 cm)

M 1000	Art. P1N	124,90€
M 2000 (centrale)	Art. P1N	124,90€

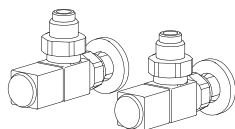

KIT VALVOLE QUADRA a SQUADRA  
 pag.271    Art. KQS    166,80€  
 Colore tabella BREM    supplemento    49,50€

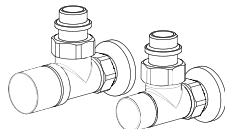

KIT VALVOLE CYL termostattabile a SQUADRA  
 pag.273    Art. KCS    138,80€  
 Colore tabella BREM    supplemento    49,50€

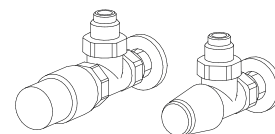

KIT VALVOLE TON a SQUADRA con Testa TERMOSTATICA, pag.269    Art. KTS    176,20€

# META M7 PASSO 50 COLONNA SEMPLICE

PREZZI DAL 01.03.2026 + 5%

LAME

MOD. M7 BASSO	(n° el) L cm H cm	EN 442 Watt Δt 50K (Δt 40K = Wx0,755) (Δt 30K = Wx0,526)										
		10 el.	12 el.	14 el.	16 el.	18 el.	20 el.	22 el.	24 el.	26 el.	28 el.	30 el.
	49,5 ▲▽ 40	49,5 40	59,5 50	69,5 60	79,5 70	89,5 80	99,5 90	109,5 100	119,5 110	129,5 120	139,5 130	149,5 140
M7 1050/50	€ w H 50	263,40 372w	297,90 446w	332,10 521w	366,60 595w	401,00 670w	435,40 744w	469,80 818w	504,30 893w	538,50 967w	573,20 1042w	607,40 1116w
M7 1060/50	€ w H 60	279,70 438w	315,90 526w	352,10 613w	388,40 701w	424,50 788w	460,70 876w	496,90 964w	533,10 1051w	569,40 1139w	605,60 1226w	641,80 1314w
M7 1075/50	€ w H 75	309,40 530w	351,70 636w	393,80 742w	436,00 848w	478,10 954w	520,30 1060w	562,40 1166w	604,60 1272w	646,80 1378w	688,90 1484w	731,20 1590w
M7 1090/50	€ w H 90	331,40 636w	377,90 763w	424,50 890w	471,20 1018w	517,60 1145w	564,20 1272w	610,80 1399w	657,30 1526w	703,80 1654w	750,50 1781w	797,10 1908w

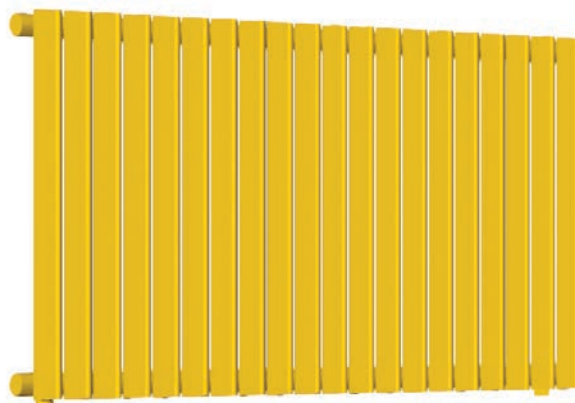

META 1000

MODELLO M7 ALTO	(n° el) L cm H cm	5 el.	6 el.	7 el.	8 el.	9 el.	10 el.	11 el.	12 el.	13 el.	14 el.	15 el.
	24,5 ▲▽ 15	24,5 15	29,5 20	34,5 25	39,5 30	44,5 35	49,5 40	54,5 45	59,5 50	64,5 55	69,5 60	74,5 65
M7 1160/50	€ w H 160	286,20 535w	323,60 642w	361,20 749w	398,60 856w	436,20 964w	473,60 1070w	511,30 1177w	548,80 1284w	586,30 1391w	623,80 1499w	661,30 1605w
M7 1180/50	€ w H 180	306,10 602w	347,60 722w	389,20 843w	430,80 963w	472,30 1084w	513,80 1204w	555,30 1324w	596,90 1445w	638,30 1565w	679,90 1686w	721,40 1806w
M7 1200/50	€ w H 200	325,60 652w	370,90 782w	416,30 912w	461,70 1042w	507,30 1173w	552,70 1303w	598,00 1433w	643,40 1564w	688,70 1694w	734,30 1824w	779,60 1955w
M7 1220/50	€ w H 220	357,20 715w	409,10 857w	460,70 1000w	512,40 1143w	564,20 1286w	615,90 1429w	667,70 1572w	719,40 1715w	771,20 1858w	822,80 2001w	874,70 2144w

Δt diversi da 50 K: consultare Dati tecnici Brem

Tabelle complete pag. 20-21

Modello META    prof. colonna    colonna semplice    altezza cm    passo mm    n° el

M 7    1 200/50- 8 el

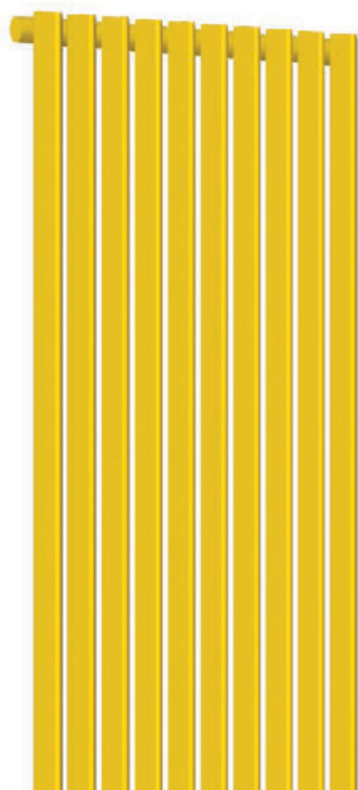

META 1000



# META M7 PASSO 50 COLONNA DOPPIA

PREZZI DAL 01.03.2026 +5%

LAME

MOD. M7	(n° el)	10 el.	12 el.	14 el.	16 el.	18 el.	20 el.	22 el.	24 el.	26 el.	28 el.	30 el.
BASSO	L cm	49,5	59,5	69,5	79,5	89,5	99,5	109,5	119,5	129,5	139,5	149,5
H cm	▲▼	40	50	60	70	80	90	100	110	120	130	140
M7 2050/50	€	462,20	530,00	598,10	666,20	734,30	802,10	870,20	938,40	1006,40	1074,30	1142,40
H 50	w	627w	752w	878w	1003w	1129w	1254w	1379w	1505w	1630w	1756w	1881w
M7 2060/50	€	503,50	579,70	656,10	732,30	808,70	885,00	961,40	1037,60	1114,00	1190,30	1266,60
H 60	w	741w	889w	1037w	1186w	1334w	1482w	1630w	1778w	1927w	2075w	2223w
M7 2075/50	€	562,90	651,20	739,30	827,70	915,70	1004,10	1092,20	1180,40	1268,60	1356,90	1445,10
H 75	w	911w	1093w	1275w	1458w	1640w	1822w	2004w	2186w	2369w	2551w	2733w
M7 2090/50	€	625,00	725,80	826,20	926,90	1027,50	1128,20	1228,80	1329,50	1430,00	1530,80	1631,40
H 90	w	1091w	1309w	1527w	1746w	1964w	2182w	2400w	2618w	2837w	3055w	3273w

EN 442 W<sub>eff</sub> Δt 50K (Δt 40K = Wx0,755) (Δt 30K = Wx0,526)

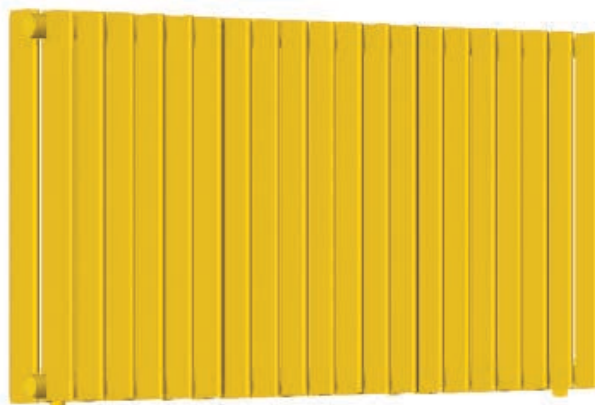

META 2000

MODELLO M7	(n° el)	5 el.	6 el.	7 el.	8 el.	9 el.	10 el.	11 el.	12 el.	13 el.	14 el.	15 el.
ALTO	L cm	24,5	29,5	34,5	39,5	44,5	49,5	54,5	59,5	64,5	69,5	74,5
H cm	▲▼	15	20	25	30	35	40	45	50	55	60	65
M7 2160/50	€	515,70	594,60	673,20	752,10	830,80	909,70	988,40	1067,20	1145,90	1224,60	1303,40
H 160	w	927w	1112w	1298w	1483w	1668w	1853w	2039w	2224w	2410w	2595w	2780w
M7 2180/50	€	556,50	643,40	730,30	817,20	904,10	991,00	1078,10	1165,00	1251,90	1338,80	1425,70
H 180	w	1043w	1251w	1460w	1668w	1877w	2085w	2294w	2502w	2711w	2919w	3128w
M7 2200/50	€	597,20	692,40	787,30	882,40	977,50	1072,60	1167,50	1262,70	1357,80	1452,90	1547,90
H 200	w	1157w	1388w	1620w	1851w	2083w	2314w	2545w	2777w	3008w	3240w	3471w
M7 2220/50	€	637,20	740,40	843,40	946,70	1049,70	1152,90	1255,80	1358,80	1462,00	1565,00	1668,20
H 220	w	1272w	1526w	1780w	2034w	2289w	2543w	2797w	3052w	3306w	3560w	3815w

Δt diversi da 50 K: consultare Dati tecnici Brem

Tabelle complete pag.20-21

## ORDINE

Indicare: modello, colonna se semplice o doppia, altezza in cm, passo in mm, numero elementi; l'allacciamento e il colore  
Es.: M7 2 200-70 6 el, AC ø 1/2" BR0033

Modello prof. colonna altezza passo n°  
META colonna doppia cm mm el  
M7 2 180/50- 14 el

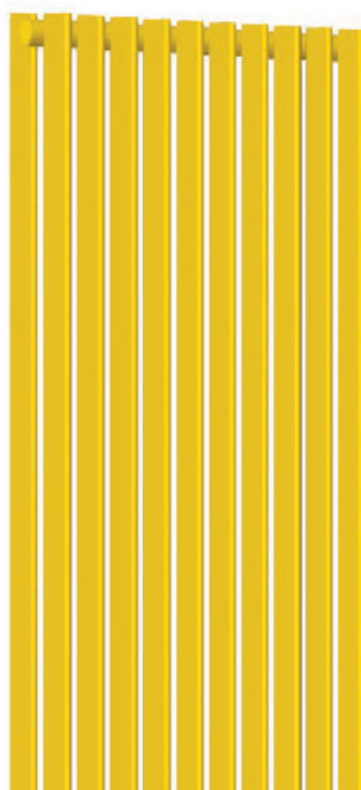

META 2000



# META 1000

## TABELLA COMPLETA DI RESE E PREZZI

PREZZI DAL 01.03.2026 +5%

MOD. passo PE	..30		..35		..40		..45		..50		..55		..60		..65		..70		PREZZO	
	colonna		M5	M7	M5	M7	M5	M7	M5	M7	M5	M7	M5	M7	M5	M7	M5	M7	elemento	fisso
	H	w/el.	w/el.	w/el.	w/el.	w/el.	w/el.	w/el.	w/el.	w/el.	w/el.	w/el.	w/el.	w/el.	w/el.	w/el.	w/el.	€ x n°el. + €		
M..1030..	18,6	21,6	19,3	22,4	20,0	23,2	20,9	24,0	21,7	24,8	22,5	25,7	23,3	26,6	24,1	27,4	24,9	28,1	14,9	91,2
M..1035..	20,9	25,1	21,7	25,9	22,5	26,8	23,4	27,7	24,2	28,5	25,0	29,4	25,8	30,3	26,6	31,1	27,4	31,9	15,3	91,3
M..1040..	23,0	27,1	23,8	28,1	24,7	29,0	25,6	29,8	26,5	30,5	27,3	31,7	28,2	32,9	29,0	33,9	29,9	34,9	15,8	91,3
M..1045..	25,7	30,1	26,6	31,0	27,4	32,0	28,2	33,1	29,1	34,2	29,8	35,0	30,6	35,8	31,4	37,2	32,2	38,6	16,4	91,2
M..1050..	28,0	32,3	28,9	33,6	29,8	34,9	30,7	36,0	31,6	37,2	32,5	38,4	33,3	39,5	34,1	40,6	35,0	41,6	17,2	91,4
M..1055..	30,9	35,3	31,8	36,6	32,8	37,9	33,7	39,4	34,6	40,8	35,4	41,7	36,2	42,5	37,1	43,9	38,0	45,3	17,5	91,4
M..1060..	33,0	38,2	34,0	39,5	35,0	40,8	35,9	42,3	36,9	43,8	37,8	45,0	38,6	46,2	39,5	47,2	40,5	48,3	18,1	98,7
M..1065..	35,3	41,0	36,4	42,4	37,4	43,8	38,5	45,6	39,6	47,5	40,6	48,3	41,6	49,2	42,6	50,6	43,6	52,0	19,1	98,6
M..1070..	37,3	43,2	38,5	45,0	39,8	46,7	41,0	48,6	42,2	50,4	43,4	51,7	44,5	52,9	45,7	54,3	46,9	55,7	20,0	98,7
M..1075..	39,6	46,1	40,8	47,9	42,1	49,7	43,4	51,5	44,7	53,3	45,9	54,6	47,0	55,9	48,3	57,3	49,5	58,6	21,1	98,5
M..1080..	42,3	49,0	43,5	50,8	44,8	52,6	46,0	54,8	47,2	57,0	48,2	58,3	49,3	59,6	50,5	61,0	51,7	62,3	22,1	98,6
M..1090..	46,8	55,7	48,3	57,4	49,7	59,2	51,2	61,4	52,7	63,6	54,0	64,9	55,3	66,2	56,7	67,6	58,2	69,0	23,3	98,6
M..1100..	52,6	61,3	54,0	63,2	55,4	65,1	56,7	67,2	58,1	69,4	59,3	71,1	60,4	72,8	61,8	74,3	63,1	75,7	25,1	98,6
M..1110..	57,6	67,1	59,0	69,0	60,5	70,9	62,0	73,4	63,5	75,9	64,8	77,7	66,0	79,5	67,5	81,3	69,0	83,1	27,4	98,6
M..1120..	61,9	72,2	63,5	74,5	65,1	76,7	66,7	79,6	68,3	82,4	69,6	84,3	71,0	86,1	72,6	87,9	74,2	89,7	29,2	98,6
M..1150..	77,7	88,7	79,5	91,4	81,3	94,2	83,1	97,7	84,9	101,1	86,3	103,5	87,8	105,9	89,6	107,8	91,5	109,6	34,3	98,6
M..1160..	81,2	93,7	83,3	96,8	85,4	99,9	87,6	103,8	89,7	107,6	91,5	110,0	93,2	112,5	95,4	114,7	97,6	117,0	37,5	98,5
M..1175..	89,2	103,0	91,3	106,2	93,5	109,3	95,6	113,1	97,8	116,9	99,5	119,4	101,2	122,0	103,5	124,3	105,8	126,6	39,5	98,6
M..1180..	92,1	106,0	94,2	109,1	96,4	112,2	98,6	116,3	100,8	120,4	102,6	123,0	104,3	125,6	106,6	127,9	108,9	130,3	41,5	98,6
M..1190..	97,1	111,8	99,4	114,8	101,7	117,9	104,1	120,9	106,4	124,0	108,2	128,1	110,0	132,3	112,5	135,8	114,9	139,3	43,6	98,7
M..1200..	102,2	117,6	104,6	120,8	107,0	124,0	109,5	127,1	111,9	130,3	113,8	134,7	115,7	139,1	118,4	142,9	121,0	146,6	45,4	98,7
M..1210..	107,2	123,4	109,8	126,7	112,3	130,1	114,9	133,4	117,5	136,6	119,5	141,3	121,5	146,0	124,2	149,9	127,0	153,9	47,6	98,5
M..1220..	112,2	129,2	114,9	132,7	117,6	136,1	120,3	139,5	123,1	142,9	125,1	147,9	127,2	152,8	130,1	157,0	133,1	161,2	51,7	98,5

La resa del calorifero si calcola moltiplicando le rese della colonna per il numero degli elementi.

Il costo della colonna è determinato solo dall'altezza, indipendentemente dalla profondità e dal passo.

Il costo del calorifero si calcola moltiplicando il prezzo della colonna per il numero degli elementi e sommando il prezzo fisso.

Modello META prof. colonna semplice altezza passo n°  
M 7 1200/70- 8 el

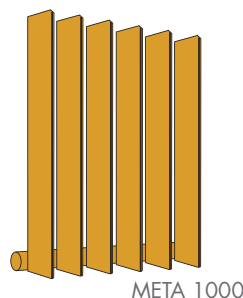

### Come scegliere il calorifero META

Dati i watt necessari per scaldare un locale (es. 1175 W) con altezza calorifero 200 cm, ricercare il numero di elementi variando il passo secondo lo spazio disponibile:

MODELLO	el.	L(cm)	W	€
M7 1200/70	8	53,5	1173	461,90
M7 1200/50	9	44,5	1173	507,30
M7 1200/30	10	31,5	1176	552,70

### LARGHEZZE DEI CALORIFERI

passo elementi	numero elementi																
	5 el	6 el	7 el	8 el	9 el	10 el	11 el	12 el	13 el	14 el	15 el	16 el	17 el	18 el	19 el		
M.../30 L cm	16,5	19,5	22,5	25,5	28,5	31,5	34,5	37,5	40,5	43,5	46,5	49,5	52,5	55,5	58,5		
M.../35 L cm	18,5	22,0	25,5	29,0	32,5	36,0	39,5	43,0	46,5	50,0	53,5	57,0	60,5	64,0	67,5		
M.../40 L cm	20,5	24,5	28,5	32,5	36,5	40,5	44,5	48,5	52,5	56,5	60,5	64,5	68,5	72,5	76,5		
M.../45 L cm	22,5	27,0	31,5	36,0	40,5	45,0	49,5	54,0	58,5	63,0	67,5	72,0	76,5	81,0	85,5		
M.../50 L cm	24,5	29,5	34,5	39,5	44,5	49,5	54,5	59,5	64,5	69,5	74,5	79,5	84,5	89,5	94,5		
M.../55 L cm	26,5	32,0	37,5	43,0	48,5	54,0	59,5	65,0	70,5	76,0	81,5	87,0	92,5	98,0	103,5		
M.../60 L cm	28,5	34,5	40,5	46,5	52,5	58,5	64,5	70,5	76,5	82,5	88,5	94,5	101,0	107,0	113,0		
M.../65 L cm	30,5	37,0	43,5	50,0	56,5	63,0	69,5	76,0	82,5	89,0	95,5	102,0	108,5	115,0	121,5		
M.../70 L cm	32,5	39,5	46,5	53,5	60,5	67,5	74,5	81,5	88,5	95,5	102,5	109,5	116,5	123,5	130,5		

# META 2000

## TABELLA COMPLETA DI RESE E PREZZI

PREZZI DAL 01.03.2026 +5%

MOD. passo PE colonna H	..-30		..-35		..-40		..-45		..-50		..-55		..-60		..-65		..-70		PREZZO	
	M5 w/el.	M7 w/el.	M5 w/el.	M7 w/el.	M5 w/el.	M7 w/el.	M5 w/el.	M7 w/el.	M5 w/el.	M7 w/el.	M5 w/el.	M7 w/el.	M5 w/el.	M7 w/el.	M5 w/el.	M7 w/el.	M5 w/el.	M7 w/el.	elemento € x n°el.	fisso + €
M..2030..	31,0	36,2	32,1	37,3	33,3	38,5	34,5	39,7	35,7	40,9	36,9	42,1	38,0	43,3	39,1	44,3	40,2	45,3	27,2	127,7
M..2035..	35,6	42,8	36,8	44,0	38,0	45,2	39,1	46,4	40,3	47,5	41,3	48,7	42,3	49,8	43,3	50,8	44,3	51,7	29,5	127,5
M..2040..	39,4	46,5	40,7	47,9	41,9	49,2	43,2	50,5	44,4	51,8	45,5	53,1	46,5	54,4	47,6	55,5	48,7	56,6	30,0	127,6
M..2045..	44,4	51,9	45,6	53,3	46,7	54,7	47,8	56,1	49,0	57,5	49,9	58,9	50,9	60,4	51,9	61,5	52,9	62,7	32,2	121,8
M..2050..	48,4	55,9	49,7	57,6	51,0	59,4	52,3	61,1	53,5	62,7	54,6	64,5	55,7	66,3	56,8	67,8	58,0	69,2	34,0	122,1
M..2055..	53,7	61,2	55,0	63,0	56,3	64,9	57,5	66,7	58,8	68,4	59,9	70,4	61,0	72,3	62,2	73,9	63,3	75,4	36,1	122,0
M..2060..	57,5	66,4	58,9	68,3	60,3	70,3	61,7	72,2	63,0	74,1	64,2	76,2	65,4	78,2	66,7	79,9	67,9	81,6	38,2	122,0
M..2065..	61,6	71,6	63,2	73,8	64,8	75,8	66,4	78,0	68,0	80,1	69,4	82,4	70,7	84,6	72,2	86,5	73,7	88,3	40,0	121,8
M..2070..	65,3	75,6	67,2	78,1	69,1	80,6	71,0	83,1	72,9	85,5	74,5	88,2	76,1	90,9	77,9	93,1	79,6	95,3	42,3	122,0
M..2075..	69,4	80,9	71,5	83,5	73,5	86,0	75,5	88,6	77,5	91,1	79,2	93,9	80,9	96,7	82,8	99,1	84,7	101,4	44,1	121,8
M..2080..	74,6	86,3	76,5	89,1	78,4	91,8	80,2	94,5	82,1	97,2	83,7	100,2	85,3	103,2	87,1	105,8	88,9	108,3	46,3	121,9
M..2090..	82,7	98,3	85,1	101,0	87,4	103,7	89,8	106,5	92,1	109,1	94,2	112,2	96,2	115,3	98,5	117,9	100,7	120,5	50,3	121,8
M..2100..	93,2	108,7	95,5	111,6	97,7	114,5	99,9	117,4	102,1	120,3	103,9	123,7	105,8	127,2	107,9	130,0	110,0	132,7	54,3	121,7
M..2110..	102,3	119,1	104,7	122,4	107,2	125,5	109,7	128,8	112,1	132,0	114,2	135,8	116,2	139,6	118,6	142,9	121,0	146,1	58,5	121,7
M..2120..	110,6	129,0	113,1	132,5	115,6	135,9	118,1	139,4	120,6	142,7	122,6	146,8	124,5	150,9	126,9	154,3	129,3	157,6	62,5	122,0
M..2150..	140,7	160,6	143,1	164,3	145,5	168,0	147,8	171,6	150,2	175,2	151,8	179,9	153,4	184,6	155,7	188,3	157,9	192,1	74,6	121,7
M..2160..	147,9	170,6	150,7	174,6	153,4	178,5	156,1	182,3	158,8	186,0	160,7	191,0	162,6	196,0	165,2	200,0	167,8	203,9	78,8	122,1
M..2175..	163,4	188,8	166,0	192,4	168,5	195,9	170,9	199,2	173,3	202,5	174,8	207,2	176,3	212,0	178,6	215,6	180,9	219,2	82,9	122,1
M..2180..	169,8	195,4	172,1	198,9	174,4	202,3	176,6	205,4	178,8	208,5	180,0	213,3	181,2	217,9	183,3	221,4	185,4	224,7	86,9	121,8
M..2190..	180,2	207,4	182,4	210,8	184,6	214,0	186,8	217,0	188,8	220,0	189,8	224,7	190,8	229,4	192,8	232,8	194,7	236,0	91,1	121,8
M..2200..	190,7	219,5	192,8	222,7	194,9	225,8	196,9	228,7	198,8	231,4	199,6	236,2	200,3	240,9	202,2	244,1	203,9	247,1	95,1	121,9
M..2210..	201,3	231,7	203,3	234,8	205,3	237,7	207,1	240,3	208,9	242,8	209,4	247,6	209,8	252,2	211,5	255,3	213,1	258,2	99,1	121,8
M..2220..	212,0	244,1	213,9	247,0	215,7	249,6	217,4	252,0	218,9	254,3	219,1	258,9	219,3	263,5	220,7	266,4	222,1	269,1	103,1	122,1

Δt diversi da 50 K: consultare Dati tecnici Brem

Modello prof. colonna altezza passo n°  
META colonna doppia cm cm el  
M 7 2 180/70- 20 el

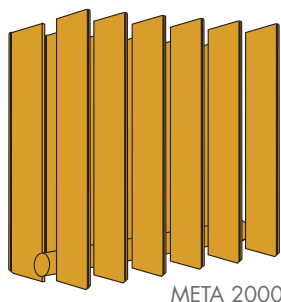

### Come scegliere il calorifero META

Dati i watt necessari per scaldare un locale (es. 1620 W) con altezza calorifero 75 cm, ricercare il numero di elementi variando il passo secondo lo spazio disponibile:

MODELLO	el	l(cm)	W	€
M7 2075/70	16	109,5	1622	827,40
M7 2075/50	18	89,5	1640	915,60
M7 2075/30	20	61,5	1618	1003,80

numero elementi														Larghezze con 3 elementi solo con attacchi laterali	
20 el	21 el	22 el	23 el	24 el	25 el	26 el	27 el	28 el	29 el	30 el	31 el	32 el	MOD.	da 33 elementi a 6 m	
61,5	64,5	67,5	70,5	73,5	76,5	79,5	82,5	85,5	88,5	91,5	94,5	97,5	M../30	(n°el -1) x 30 + 45	
71,0	74,5	78,0	81,5	85,0	88,5	92,0	95,5	99,0	102,5	106,0	109,5	113,0	M../35	(n°el -1) x 35 + 45	
80,5	84,5	88,5	92,5	96,5	100,5	104,5	108,5	112,5	116,5	120,5	124,5	128,5	M../40	(n°el -1) x 40 + 45	
90,0	94,5	99,0	103,5	108,0	112,5	117,0	121,5	126,0	130,5	135,0	139,5	144,0	M../45	(n°el -1) x 45 + 45	
99,5	104,5	109,5	114,5	119,5	124,5	129,5	134,5	139,5	144,5	149,5	154,5	159,5	M../50	(n°el -1) x 50 + 45	
109,0	114,5	120,0	125,5	131,0	136,5	142,0	147,5	153,0	158,5	164,0	169,5	175,0	M../55	(n°el -1) x 55 + 45	
118,5	124,5	130,5	136,5	142,5	148,5	154,5	160,5	166,5	172,5	178,5	184,5	190,5	M../60	(n°el -1) x 60 + 45	
128,0	134,5	141,0	147,5	154,0	160,5	167,0	173,5	180,0	186,5	193,0	199,5	206,0	M../65	(n°el -1) x 65 + 45	
137,5	144,5	151,5	158,5	165,5	172,5	179,5	186,5	193,5	200,5	207,5	214,5	221,5	M../70	(n°el -1) x 70 + 45	

REGULAR è un calorifero caratterizzato da lame in acciaio parallele, distanziate tra

loro con il passo di 5 e 8 cm a scelta. Protagonista è il tubo rettangolare di grandi

dimensioni che disposto in ritmi regolari varia le rese caloriche secondo il passo.

## DIMENSIONI

Altezze: 53/65/75/85/  
157/177/197/217/237 cm  
Larghezze: da 22 a 202 cm  
Profondità: 8 cm  
Sporgenza: 9,5 cm

## PASSO Elementi 50

L = (n° el x passo 5 cm) - 3 cm

## PASSO Elementi 80

L = (n° el x passo 8 cm) - 6 cm

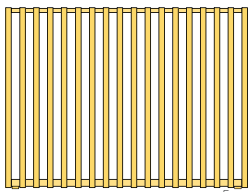

PASSO 50

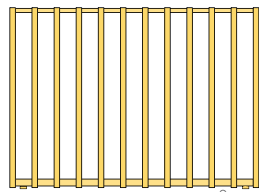

PASSO 80

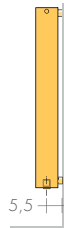

5,5

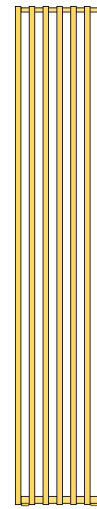

PASSO 50

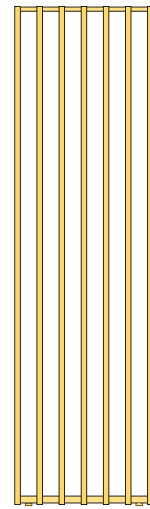

PASSO 80

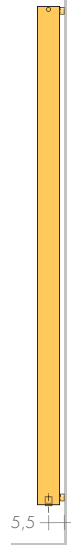

5,5

EN 442 Watt  $\Delta t$  50K ( $\Delta t$  40K =  $W \times 0,755$ ) ( $\Delta t$  30K =  $W \times 0,526$ )

MOD.	n° el passo cm	8 el		10 el		12 el		14 el		16 el		18 el		20 el		22 el		24 el		26 el		30 el
		/50	/80	/50	/80	/50	/80	/50	/80	/50	/80	/50	/80	/50	/80	/50	/80	/50	/80	/50	/80	/50
	H cm	37	58	47	74	57	90	67	106	77	122	87	138	97	154	107	170	117	186	127	202	147
	L cm	30	48	40	64	50	80	60	96	70	112	80	128	90	144	100	160	110	176	120	192	140
R 53/..	53	€ 478,50	560,10	641,60	723,00	804,50	886,10	967,50	1049,00	1130,40	1212,00	1375,00										
	w	334	393	417	491	500	589	584	687	667	786	751	884	834	982	917	1080	1001	1178	1084	1277	1251
R 65/..	65	€ 499,30	584,60	669,90	755,40	840,70	926,20	1011,60	1096,70	1182,30	1267,70	1438,40										
	w	410	482	512	602	614	722	717	843	819	963	922	1084	1024	1204	1126	1324	1229	1445	1331	1565	1536
R 75/..	75	€ 530,40	622,10	714,00	805,90	897,60	989,50	1081,30	1173,20	1264,90	1356,90	1540,60										
	w	472	556	590	695	708	834	826	973	944	1112	1062	1251	1180	1390	1298	1529	1416	1668	1534	1807	1770
R 85/..	85	€ 561,30	659,60	758,00	856,40	954,60	1052,80	1151,20	1249,50	1347,80	1446,10	1642,70										
	w	535	630	669	787	803	944	937	1102	1070	1259	1204	1417	1338	1574	1472	1731	1606	1889	1739	2046	2007

Valori intermedi per interpolazione

MOD.	n° el passo mm	5 el		6 el		7 el		8 el		9 el		10 el		11 el		12 el		13 el		15 el	
		/50	/80	/50	/80	/50	/80	/50	/80	/50	/80	/50	/80	/50	/80	/50	/80	/50	/80	/50	
	H cm	22	34	27	42	32	50	37	58	42	66	47	74	52	82	57	90	62	98	72	
	L cm	15	24	20	32	25	40	30	48	35	56	40	64	45	72	50	80	55	88	65	
R 160/..	157	€ 737,20	825,10	913,10	1001,10	1089,10	1176,90	1264,80	1352,90	1440,80	1616,70										
	w	599	708	718	849	838	991	958	1132	1077	1274	1197	1415	1317	1557	1436	1698	1556	1840	1796	1796
R 180/..	177	€ 772,20	863,90	955,80	1047,80	1139,60	1231,40	1323,20	1415,10	1507,00	1690,50										
	w	675	798	810	957	945	1117	1080	1276	1215	1436	1350	1595	1485	1755	1620	1914	1755	2074	2025	2025
R 200/..	197	€ 807,20	903,00	998,80	1094,50	1190,10	1285,80	1381,50	1477,40	1573,00	1764,40										
	w	751	888	901	1065	1051	1243	1202	1420	1352	1598	1502	1775	1652	1953	1802	2130	1953	2308	2253	2253
R 220/..	217	€ 842,20	941,90	1041,60	1141,10	1240,70	1340,30	1440,00	1539,40	1639,10	1838,30										
	w	828	978	993	1173	1159	1369	1324	1564	1490	1760	1655	1955	1821	2151	1986	2346	2152	2542	2483	2483
R 240/..	237	€ 877,30	980,70	1084,20	1187,70	1291,20	1394,70	1498,10	1601,70	1705,10	1912,10										
	w	904	1068	1084	1282	1265	1495	1446	1709	1626	1922	1807	2136	1988	2350	2168	2563	2349	2777	2711	2711

Altezze intermedie, ogni 10 cm, per interpolazione, altezze diverse o inferiori, a preventivo.

$\Delta t$  diversi da 50 K: consultare Dati tecnici Brem

Es: R 220/50 - 5el - EG  $\varnothing$  1/2" - SB 3061

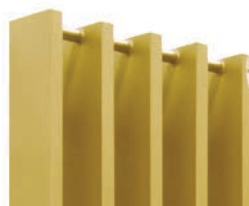

## ESECUZIONI DI SERIE

Colore bianco sablé SB9016 mensola B15  
Tolleranze  $\pm$  3mm - Valvola di sfianto  $\varnothing$  1/8"  
PRESSIONE MASSIMA D'ESERCIZIO 4 BAR

## ESECUZIONI A RICHIESTA

Verniciatura in una tinta della tabella colori  
Brem (con fissaggi B15 colorati) +15/25%  
Versione elettrica, e.Regular p.255

## ATTACCHI DI SERIE

EG  $\varnothing$  1/2"  
A richiesta attacchi  $\varnothing$  3/8"  
Attacchi speciali, pag.278



INTERASSE ATTACCHI

REGULAR PASSO 50 mm (PE50)

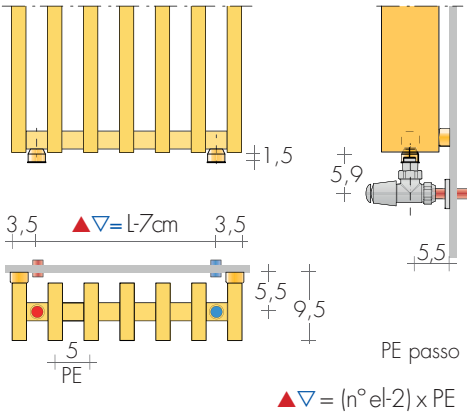

REGULAR PASSO 80 mm (PE80)

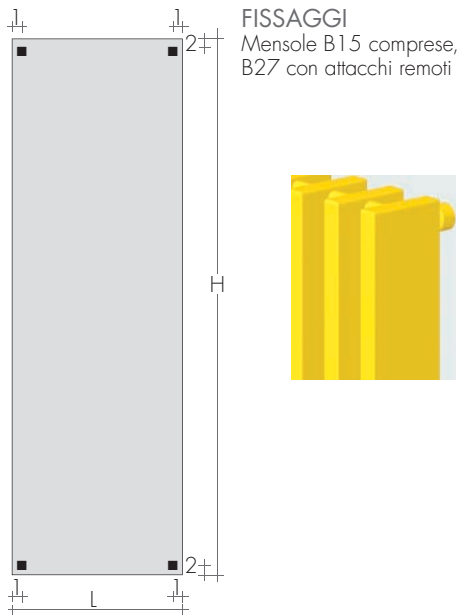
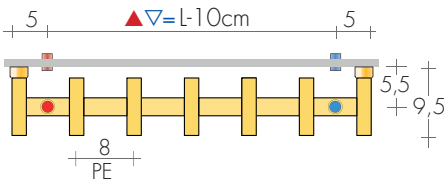

VALVOLE CONSIGLIATE

KIT VALVOLE CROMATE comprende:

- n°2 Valvole con codoli
- n°2 Raccordi (per multistrato ø16 e rame ø12 e 14)
- n°2 Rosette tonde cromo ø 48, foro ø16

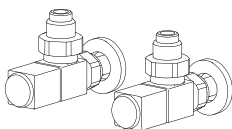

KIT VALVOLE QUADRA a SQUADRA pag.271 Art. KQS 166,80€  
Colore tabella BREM supplemento 49,50€

FINITURE SPECIALI

pag. 267  
Finiture Oro, Bronzo, Nickel spazzolato per 2 valvole  
KIT Raccordi NICKEL spazz. suppl.Art. RN 28,20€

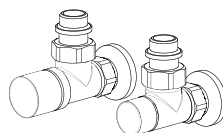

KIT VALVOLE CYL termostattabile a SQUADRA pag.273 Art. KCS 138,80€  
Colore tabella BREM supplemento 49,50€

ATTACCHI REMOTI

Art. REM 37,60€  
Interasse attacchi sul retro:  $\Delta \nabla$  EG  
Valvole REMOTE pag. 274

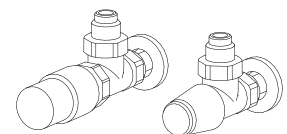
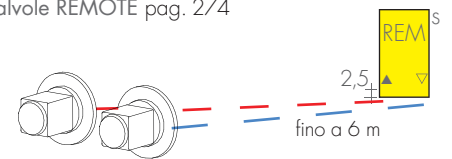

KIT VALVOLE TON a SQUADRA con Testa TERMOSTATICA, pag.269 Art. KTS 176,20€

# SBARRA SBARRA-UP

PREZZI DAL 01.03.2026 +5%

design Luigi Brembilla

Il modelli SBARRA e SBARRA-Up sono l'ideale là dove le esigenze dello spazio a disposi-

zione impongono di sfruttare ogni centimetro. Con il loro design minimalista possono essere

utilizzati in ogni ambiente mimetizzandosi o, col colore, essere protagonisti.

LAME

## DIMENSIONI

Larghezze: 120/160 cm  
Altezze: 8 / 18 / 28 cm  
Profondità: 5,8 / 8 cm  
Sporgenza dal muro: 9/11,5 cm

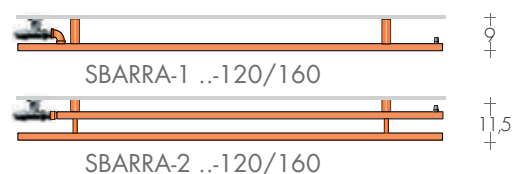
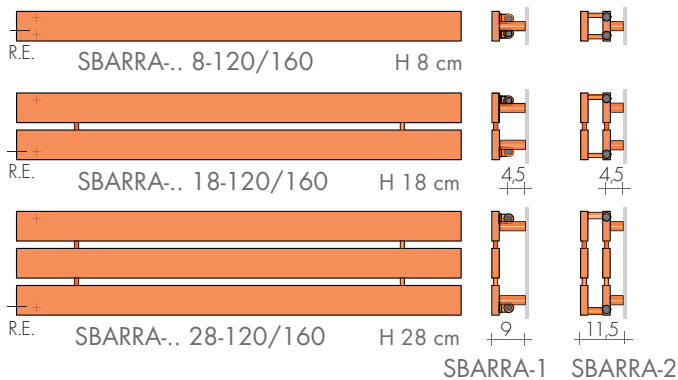

## DIMENSIONI

Larghezze: 8 / 18 / 28 cm  
Altezze: 180/200/220 cm  
Profondità: 5,8 / 8 cm  
Sporgenza dal muro: 9/11,5 cm

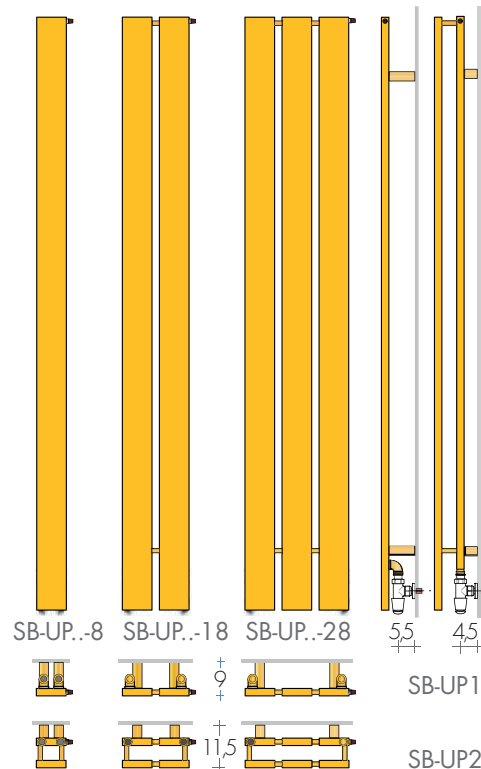

MODELLO	HL cm	Bianco di serie sablé SB9016 €	EN 442 $\Delta t$ 50K watt	$\blacktriangle \nabla$ int.att. cm	VERSIONI MISTE con Resistenza e manicotto	
					Watt	€
SBARRA-1	8-120	358,10	138	4,5	-	-
SBARRA-1	8-160	403,20	184	4,5	-	-
SBARRA-1	18-120	453,80	265	14	300	116,10
SBARRA-1	18-160	507,30	353	14	400	117,20
SBARRA-1	28-120	549,80	380	24	400	117,20
SBARRA-1	28-160	611,10	507	24	500	119,30
SBARRA-2	8-120	706,00	226	4,5	250	115,10
SBARRA-2	8-160	780,30	301	4,5	300	116,10
SBARRA-2	18-120	887,80	434	14	500	119,30
SBARRA-2	18-160	977,40	578	14	650	121,30
SBARRA-2	28-120	1070,10	623	24	650	121,30
SBARRA-2	28-160	1175,10	831	24	800	125,70

Prezzi e rese delle lunghezze intermedie, per interpolazione. lunghezze 180, 200 e 220, valori come SB-UP.

Termostati p.208-209

## VERSIONI MISTE

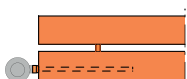

APPENDINI pag. 277

## VERSIONI MISTE

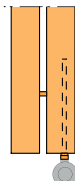

MODELLO	L H cm	8			18			28			
		cm	$\blacktriangle \nabla$ cm	4,5	14	24	cm	$\blacktriangle \nabla$ cm	4,5	14	24
SB-UP1 180	€	418,70	197w	522,50	378w	626,50	543w				
SB-UP2 180	€	795,80	323w	992,90	619w	1190,40	884w				
SB-UP1 200	€	435,30	219w	539,30	420w	643,10	603w				
SB-UP2 200	€	812,30	359w	1009,60	688w	1206,90	982w				
SB-UP1 220	€	451,80	240w	555,70	462w	659,60	664w				
SB-UP2 220	€	828,90	394w	1026,20	757w	1223,50	1081w				

A richiesta: modelli con altezze da 160 a 300 cm

Modelli in versione mista a richiesta

- SB-UP1 180-18 400W
- SB-UP1 180-28 500W
- SB-UP2 180-8 300W
- SB-UP2 180-18 650W
- SB-UP2 180-28 900W
- SB-UP1 220-8 250W
- SB-UP1 220-18 500W
- SB-UP1 220-28 650W
- SB-UP2 220-8 400W
- SB-UP2 220-18 800W
- SB-UP1 200-18 400W
- SB-UP1 200-28 650W

## ESECUZIONI DI SERIE

Colore bianco sablé SB9016 mensole bianche  
Tolleranze  $\pm$  3mm - Valvola di sfianto  $\varnothing$  1/8"  
PRESSIONE MASSIMA D'ESERCIZIO 4 BAR

## ESECUZIONI A RICHIESTA

Verniciatura in una tinta della tabella colori  
Brem con fissaggi colorati +15/25%  
Versione elettrica e.Sbarra, pag.256

## ATTACCHI DI SERIE

Modelli orizzontali AC  $\varnothing$  1/2"  
Modelli verticali REG  $\varnothing$  1/2"  
mensole B 35 mm p=5,5 (SB-UP1)

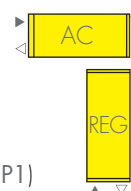

INTERASSE ATTACCHI

MOD. SBARRA

SBARRA.. 8..

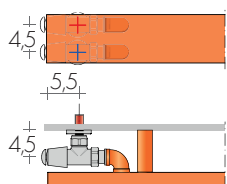

SBARRA.. 18..

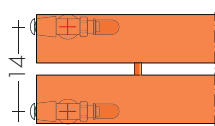

SBARRA.. 28..

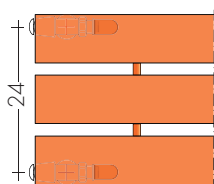

VALVOLE CONSIGLIATE

KIT VALVOLE COMPRENDE:

- n°2 Valvole con codali cromo
- n°2 Raccordi (per multistrato ø16 e rame ø12, 14)
- n°2 Rosette tonde cromo ø 48, foro ø16

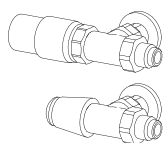
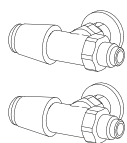

KIT VALVOLE TON REVERSE  
pag.269 Art. KVR 127,00€

KIT VALVOLE TON REVERSE con Testa  
TERMOSTATICA Art. KTR 176,20€  
pag. 269

MOD. SBARRA-UP

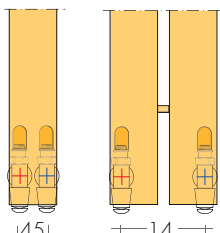

SB-UP..-8 SB-UP..-18

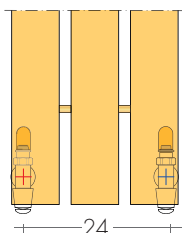

SB-UP..-28

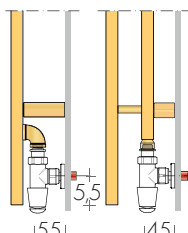

SB-UP1 SB-UP2

VALVOLE CONSIGLIATE

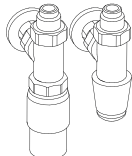
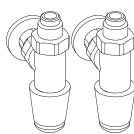

KIT VALVOLE TON REVERSE  
pag.269 Art. KVR 127,00€

KIT VALVOLE TON REVERSE con Testa  
TERMOSTATICA Art. KTR 176,20€  
pag. 269

ATTACCHI REMOTI Art. REM 37,60€

SBARRA: sul retro ▲▽ AC standard

SBARRA -UP: sul retro ▲▽ REG

VALVOLE REMOTE pag. 274

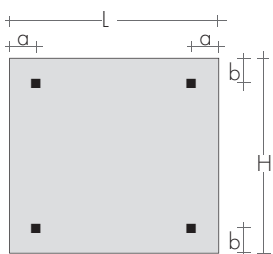

FISSAGGI

Mensole comprese

Mod.	a cm	b cm
SBARRA.. H8	16	2
SBARRA.. H18	16	4
SBARRA.. H28	16	4
SB-UP ..-8	2	16
SB-UP ..-18	4	16
SB-UP ..-28	4	16



SBARRA-2 18-120



SB-UP1 180-8

TORRI nasce dalla sfida di rendere un calorifero alto e slanciato come un

vero elemento architettonico all'interno dell'ambiente. Realizzato in lame d'acciaio

design *Bettazzi + Percoco*  
parallele si eleva da terra verso l'alto con la parte sommitale tagliata ad angoli diversi.

## DIMENSIONI

Altezze: 177/197/217/237 cm

Larghezze: da 22 a 98 cm

Profondità: 9,5 cm

Sporgenza: 11 cm

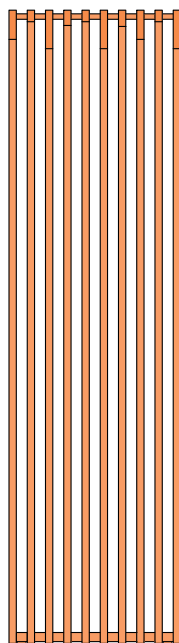

PASSO Elementi 50 (PE50)  
L = n° el x passo 5 cm - 3 cm

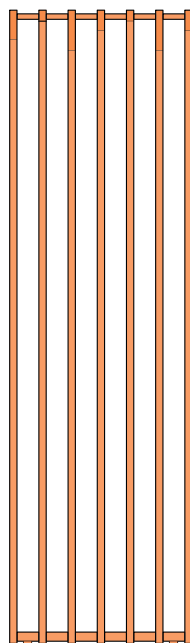

PASSO Elementi 80 (PE80)  
L = n° el x passo 8 cm - 6 cm

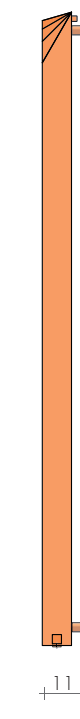

Mod. TO.../50

Mod. TO.../80

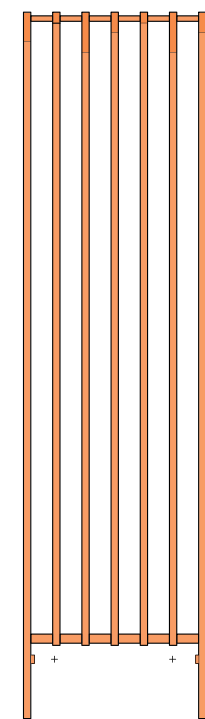

Mod. TOB...

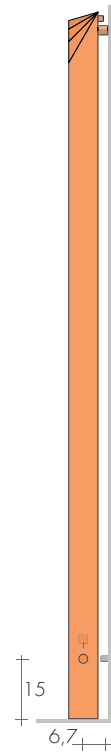

MOD.	n° el passo mm	5 el		6 el		7 el		8 el		9 el		10 el		11 el		12 el		13 el		15 el
		/50	/80	/50	/80	/50	/80	/50	/80	/50	/80	/50	/80	/50	/80	/50	/80	/50	/80	/50
	H cm	22	34	27	42	32	50	37	58	42	66	47	74	52	82	57	90	62	98	72
	L cm	15	24	20	32	25	40	30	48	35	56	40	64	45	72	50	80	55	88	65
TO 180/..	€	839,50	939,30	1039,20	1139,00	1238,90	1338,60	1438,50	1538,40	1638,20	1837,80									
177	w	675 798	810 957	945 1117	1080 1276	1215 1436	1350 1595	1485 1755	1620 1914	1755 2074	2025									
TO 200/..	€	878,00	982,10	1086,10	1190,30	1294,30	1398,40	1502,70	1606,70	1710,80	1919,00									
197	w	751 888	901 1065	1051 1243	1202 1420	1352 1598	1502 1775	1652 1953	1802 2130	1953 2308	2253									
TO 220/..	€	915,60	1023,90	1132,10	1240,40	1348,60	1456,90	1565,10	1673,40	1781,50	1998,00									
217	w	828 978	993 1173	1159 1369	1324 1564	1490 1760	1655 1955	1821 2151	1986 2346	2152 2542	2483									
TO 240/..	€	954,00	1066,60	1179,20	1291,50	1404,10	1516,60	1629,20	1741,70	1854,20	2079,20									
237	w	904 1068	1084 1282	1265 1495	1446 1709	1626 1922	1807 2136	1988 2350	2168 2563	2349 2777	2711									

Altezze intermedie, ogni 10 cm, per interpolazione, altezze diverse o inferiori, a preventivo.

EN 442 Watt Δt 50K (Δt 40K = Wx0,755) (Δt 30K = Wx0,526)  
Δt diversi da 50K: consultare Dati tecnici Brem

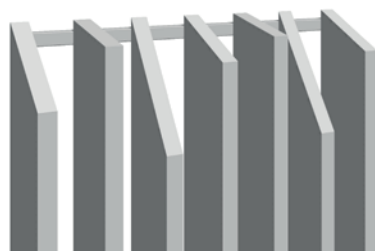

Ripetizione a destra elementi inclinati ogni 7 elementi

Es.: TO 220/80 - 9el EG ø 1/2" SB3061

## ESECUZIONI DI SERIE

Colore bianco sablé SB9016 mensole  
Tolleranze ± 3mm - Valvola di sfizio ø 1/8"  
PRESSIONE MASSIMA D'ESERCIZIO 4 BAR

## ESECUZIONI A RICHIESTA

Verniciatura in una tinta della tabella colori  
Brem (con fissaggi B27 colorati) +15/25%  
Dimensioni su misura previa fattibilità

## ATTACCHI DI SERIE

EG ø 1/2"  
A richiesta attacchi ø 3/8"  
Attacchi speciali, pag. 278



INTERASSE ATTACCHI

TORRI PASSO 50 mm (PE50)

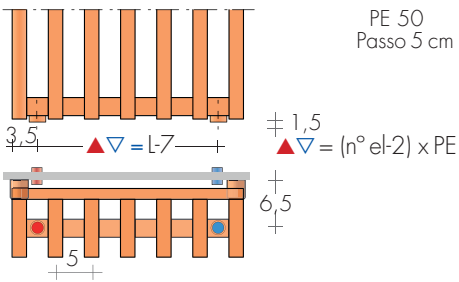

PE 50  
Passo 5 cm

TORRI PASSO 80 mm (PE80)

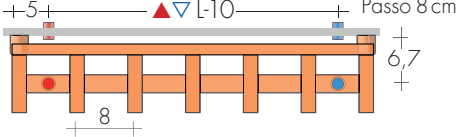

PE 80  
Passo 8 cm

TORRI con piedini h=20 cm  
Art. TOB supplemento 118,20€

Interasse attacchi REG con  
valvole reverse ▲▽ = L - 14 cm

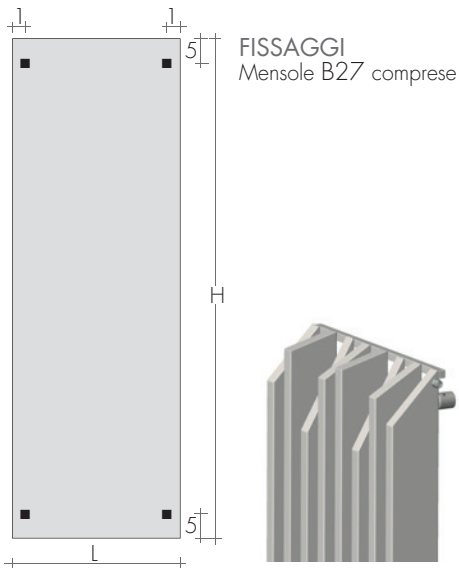
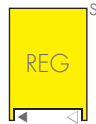

FISSAGGI  
Mensole B27 comprese



TO 220 /50- 7el

VALVOLE CONSIGLIATE

KIT VALVOLE CROMATE comprende:

- n°2 Valvole con codoli
- n°2 Raccordi (per multistrato ø16 e rame ø12 e 14)
- n°2 Rosette tonde cromo ø 48, foro ø16

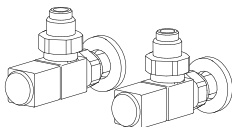

KIT VALVOLE QUADRA a SQUADRA  
pag.271 Art. KQS 166,80€  
Colore tabella BREM supplemento 49,50€

FINITURE SPECIALI

pag. 267  
Finiture Oro, Bronzo, Nickel spazzolato per 2 valvole  
KIT Raccordi NICKEL spazz. suppl.Art. RN 28,20€

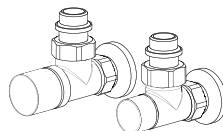

KIT VALVOLE CYL termostattabile a SQUADRA  
pag.273 Art. KCS 138,80€  
Colore tabella BREM supplemento 49,50€

ATTACCHI REMOTI

Art. REM 37,60€  
Interasse attacchi sul retro: ▲▽ EG  
Valvole REMOTE pag. 274

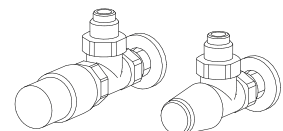
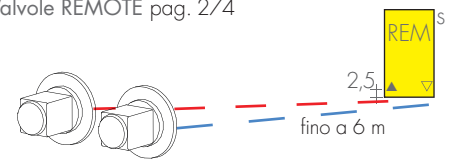

KIT VALVOLE TON a SQUADRA con Testa TERMO-  
STATICA, pag.269 Art. KTS 176,20€

design Davide Diliberto

GUEST è un portasalviette ideato per sostituire i tradizionali accessori porta asciugamani.

Le forme sono semplici, quasi bidimensionali come segni grafici, lo rendono ideale per

ambienti ristretti dove lo spazio è prezioso. Versione elettrica free standing pag. 232.

## DIMENSIONI

Larghezze: 12/22/32 cm  
 Altezze: 88/104/182/198 cm  
 Profondità: 40 cm  
 Sporgenza: dal muro 41,5 cm

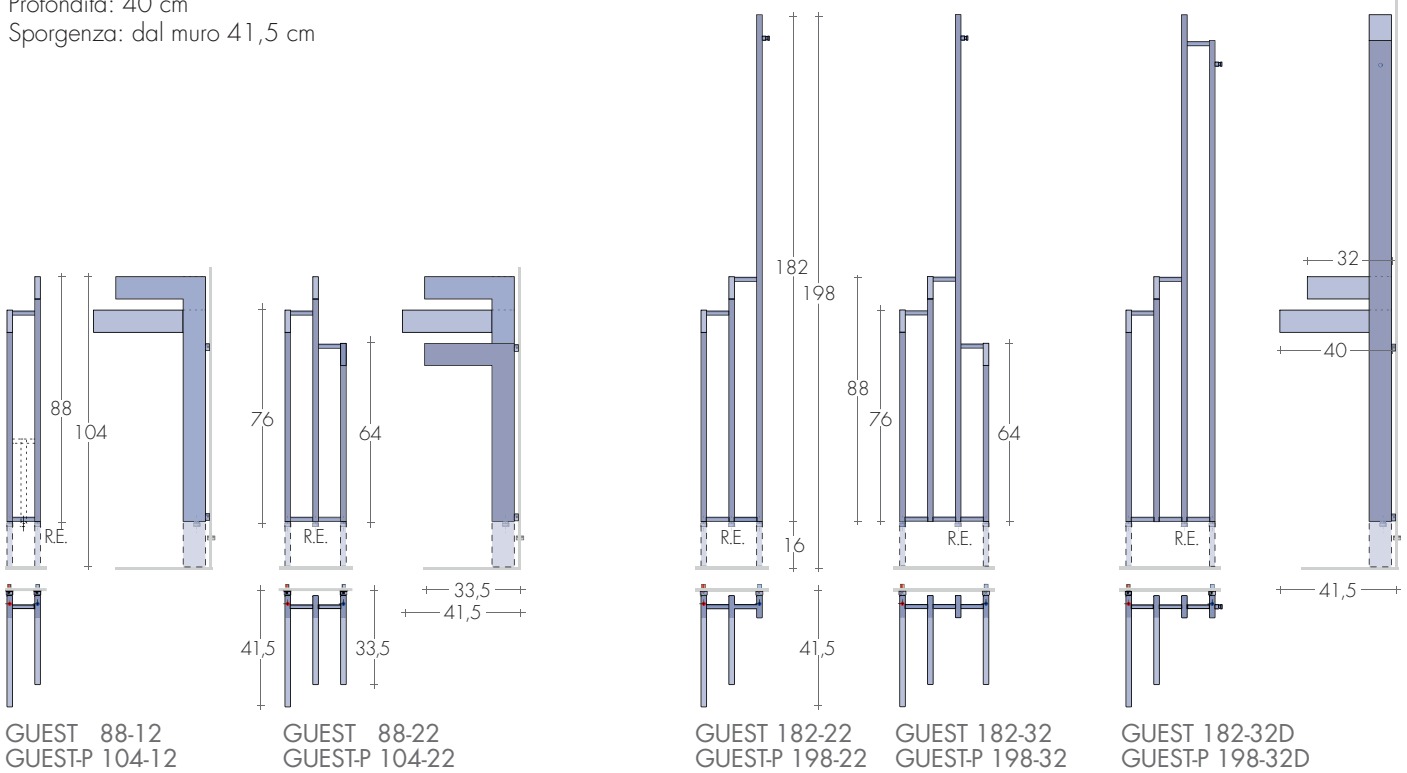

## MODELLO

MODELLO	H/L cm	Bianco di serie sablé SB 9016 €	EN 442			▲ ▼ int.att. cm	Altezza H cm	Larghezza L cm	Peso M Kg	Volume V dm <sup>3</sup>	VERSIONI MISTE con Resistenza e manico Watt €	
			Δt 50K watt	Δt 40K watt	Δt 30K watt						*250	400
GUEST 88-12	88	349,70	269	199	134	10	88	12	4,7	2,9	115,10	
GUEST 88-22	88	470,00	379	280	189	20	88	22	6,6	4,1	117,20	
GUEST 182-22	182	547,80	491	362	245	20	182	22	8,6	5,3	119,30	
GUEST 182-32	182	620,50	602	444	300	30	182	32	10,5	6,5	121,30	
GUEST 182-32D	182	672,70	700	517	349	30	182	32	12,2	7,6	121,30	
Modelli con Piedini												
GUEST-P 104-12	104	382,10	307	227	153	5	104	12	5,3	3,3	116,10	
GUEST-P 104-22	104	502,40	417	308	208	9	104	22	7,2	4,5	117,20	
GUEST-P 198-22	198	580,20	530	391	264	9	198	22	9,2	5,7	119,30	
GUEST-P 198-32	198	652,90	640	472	319	19	198	32	11,1	6,9	121,30	
GUEST-P 198-32D	198	705,10	738	545	368	19	198	32	12,8	8,0	125,70	

Modelli realizzati in versione ribaltata a destra, senza supplemento.

\*Solo resistenza con cavo  
Termostati p.208-209

## ESECUZIONI DI SERIE

Colore bianco sablé SB9016 mensole B15  
 Tolleranze ± 3mm - Valvola di sfianto ø 1/8"  
 PRESSIONE MASSIMA D'ESERCIZIO 4 BAR

## ESECUZIONI A RICHIESTA

Verniciatura in una tinta della tabella colori  
 Brem (con fissaggi B15 colorati) +15/25%  
 Versione elettrica e.GUEST pag. 232

## ATTACCHI DI SERIE

EG, REG ø 1/2"  
 A richiesta attacchi ø 3/8"  
 Attacchi speciali, pag. 279

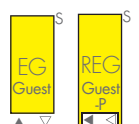

INTERASSE ATTACCHI

GUEST 88-12

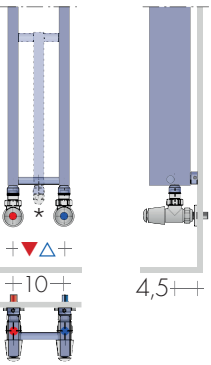

GUESTP 104-12

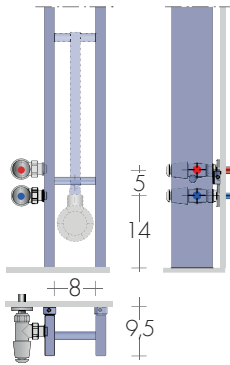

GUEST 88-22  
GUEST 182-32

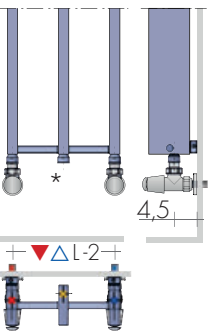

GUESTP 104-22  
GUESTP 198-32

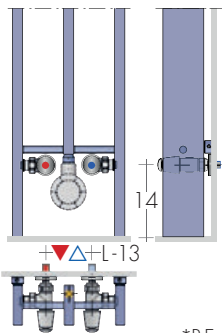

\*R.E.  
Resistenza  
Elettrica

FISSAGGI

Mensole B15 comprese,  
B35 con attacchi remoti

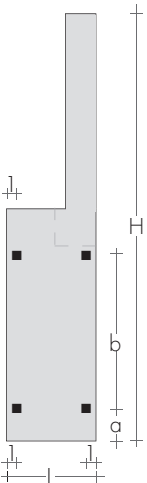

GUEST	a cm	b cm
H88 e 182 cm	1,5	61
H104 e 198 cm	17,5	61



GUEST 182-22

VALVOLE CONSIGLIATE

KIT VALVOLE CROMATE comprende:

- n°2 Valvole con codoli
- n°2 Raccordi (per multistrato ø16 e rame ø12 e 14)
- n°2 Rosette tonde cromo ø 48, foro ø16

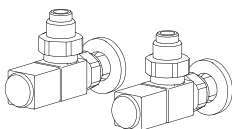

KIT VALVOLE QUADRA a SQUADRA  
pag.271 Art. KQS 166,80€  
Colore tabella BREM supplemento 49,50€

FINITURE SPECIALI

pag. 267  
Finiture Oro, Bronzo, Nickel spazzolato per 2 valvole  
KIT Raccordi NICKEL spazz. suppl.Art. RN 28,20€

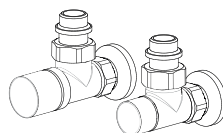

KIT VALVOLE CYL termostattabile a SQUADRA  
pag.273 Art. KCS 138,80€  
Colore tabella BREM supplemento 49,50€

ATTACCHI REMOTI

Art. REM 37,60€  
Interasse attacchi sul retro: ▲▼ EG  
Valvole REMOTE pag. 274

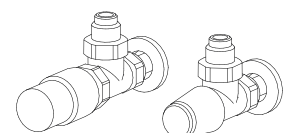
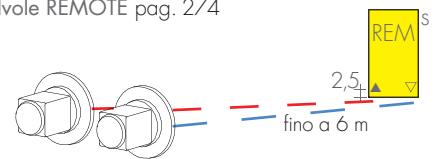

KIT VALVOLE TON a SQUADRA con Testa TERMO-  
STATICA, pag.269 Art. KTS 176,20€

design Luigi Brebbia

HERG-ÖT richiama la forma iconica della scala e può essere posizionato perpendi-

colare oppure leggermente inclinato. I tubi paralleli regalano confort e calore alla stan-

za da bagno e funzionano come appoggio per indumenti, accappatoi e salviette.

## DIMENSIONI

Larghezze: 42 / 50 / 58 cm

Altezze: 184,7 / 212,4 cm

Profondità: 12 cm

Sporgenza: 12 cm

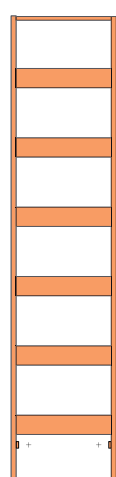
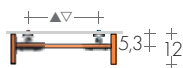

HERG-ÖT 185..

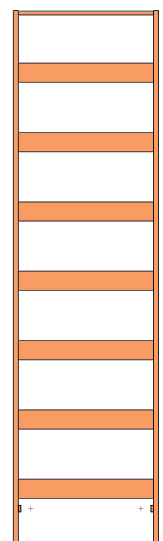
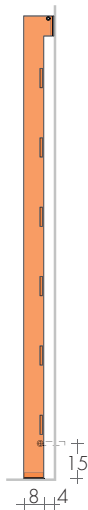

HERG-ÖT 212..

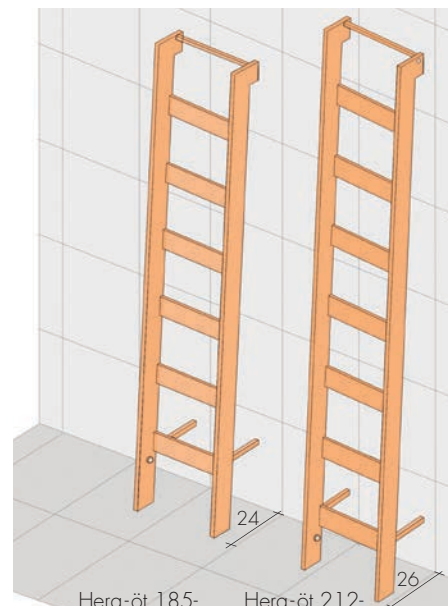
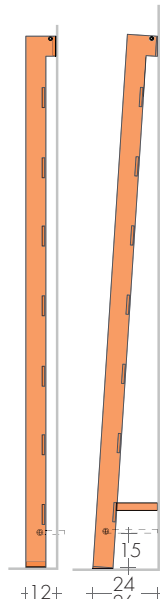

A richiesta: Versione inclinata Art. HOI

MODELLO	H/L cm	Bianco di serie sablé SB 9016 €	EN 442			▲ ▽ int.att. cm	Altezza H cm	Larghezza L cm	Peso M Kg	Volume V dm <sup>3</sup>	VERSIONI MISTE con Resistenza e manicotto	
			Δt 50 K watt	Δt 40 K watt	Δt 30 K watt						Watt	€
HERG-ÖT	185-42	888,60	625	472	329	27	184,7	42	11,5	6,0	650	121,30
HERG-ÖT	185-50	908,30	669	505	352	35	184,7	50	12,3	6,3	650	121,30
HERG-ÖT	185-58	940,50	713	538	375	43	184,7	58	13,0	6,5	650	121,30
HERG-ÖT	212-42	1016,80	735	555	387	27	212,4	42	13,5	7,1	800	125,70
HERG-ÖT	212-50	1038,60	787	594	414	35	212,4	50	14,4	7,3	800	125,70
HERG-ÖT	212-58	1075,20	840	634	442	43	212,4	58	15,3	7,6	900	129,00

A richiesta: HERG-ÖT INCLINATO supplemento Art. HOI 97,10€

Pronta consegna

Termostati p.208-209

## ESECUZIONI DI SERIE

Colore bianco sablé SB9016

Tolleranze ± 3mm - Valvola di sfianto ø 1/8"

PRESSIONE MASSIMA D'ESERCIZIO 4 BAR

## ESECUZIONI A RICHIESTA

Verniciatura in una tinta della tabella colori

Brem (con fissaggi colorati)

Versione elettrica e.Herg-ÖT

+15/25%

pag. 234

## ATTACCHI DI SERIE

REG ø 1/2"

A richiesta attacchi ø 3/8"

Attacchi speciali, pag. 279



INTERASSE ATTACCHI

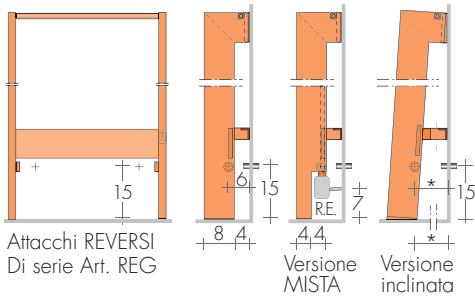

HERG-ÖT INCLINATO Herg-öt H 185:\*17,5 cm  
Herg-öt H 212:\*19,5 cm

R.E.  
Resistenza  
Elettrica

ATTACCHI REMOTI

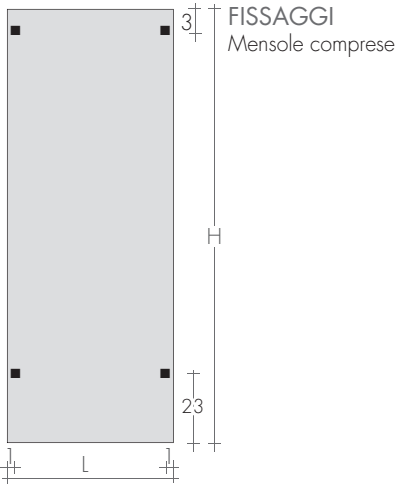
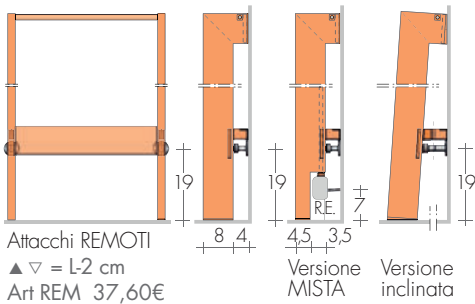

HERG-ÖT 212-42

VALVOLE CONSIGLIATE

KIT VALVOLE CROMATE comprende:

- n°2 Valvole con codoli
- n°2 Raccordi (per multistrato ø16 e rame ø12 e 14)
- n°2 Rosette tonde cromo ø 48, foro ø16

FINITURE SPECIALI

pag. 267  
Finiture Oro, Bronzo, Nickel spazzolato per 2 valvole  
KIT Raccordi NICKEL spazz. suppl.Art. RN 28,20€

ATTACCHI REMOTI

Art. REM 37,60€  
Interasse attacchi sul retro: ▲ ▽ L-2cm  
Valvole REMOTE pag. 274

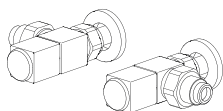
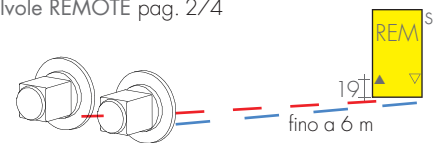

KIT VALVOLE QUADRA a SQUADRA  
pag.271 Art. KQS 166,80€  
Colore tabella BREM supplemento 49,50€

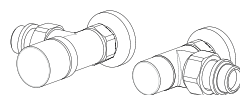

KIT VALVOLE CYL termostattabile a SQUADRA  
pag.273 Art. KCL 138,80€  
Colore tabella BREM supplemento 49,50€

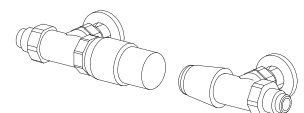

KIT VALVOLE TON a SQUADRA con Testa TERMO-  
STATICA, pag.269 Art. KTS 176,20€

design Luigi Brembilla

HERG'S è un nuovo scaldasalviette che ricorda i semplici portasalviette riscaldati.

Protagonista è il tubo rettangolare di grandi dimensioni che disposto in ritmi regolari re-

gala rese caloriche per il completo confort della sala bagno.

## DIMENSIONI

Larghezze 42 / 50 / 58 cm

Altezze 64,4 / 92,1 / 119,8 / 147,5 / 175,2 / 202,9 cm

Profondità 12 cm

Sporgenza dal muro 12 cm

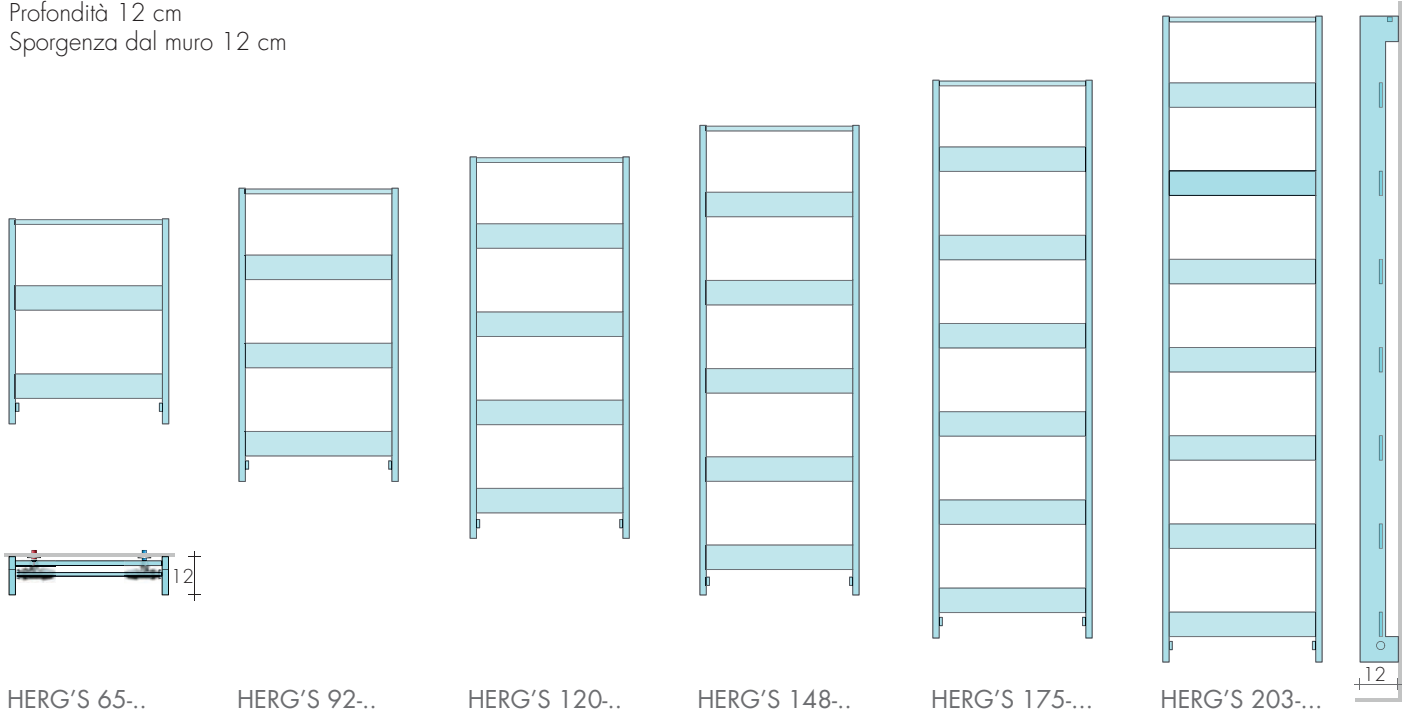

HERG'S 65-..

HERG'S 92-..

HERG'S 120-..

HERG'S 148-..

HERG'S 175-...

HERG'S 203-...

## MODELLO

MODELLO	H/L cm	Bianco di serie sablé SB 9016 €	EN 442			▲ ▼ int.att. cm	Altezza H cm	Larghezza L cm	Peso M Kg	Volume V dm <sup>3</sup>	VERSIONI MISTE con Resistenza e manicotto	
			Δt 50 K watt	Δt 40 K watt	Δt 30 K watt						Watt	€
HERG'S	65-42	476,60	249	188	131	27	64,4	42	4,6	2,4	250	115,10
HERG'S	65-50	508,20	268	202	141	35	64,4	50	4,9	2,5	300	116,10
HERG'S	92-42	573,60	350	264	184	27	92,1	42	6,4	3,3	400	117,20
HERG'S	92-50	605,20	378	285	199	35	92,1	50	6,9	3,4	400	117,20
HERG'S	120-42	670,50	452	341	238	27	119,8	42	8,3	4,2	400	117,20
HERG'S	120-50	702,10	487	368	256	35	119,8	50	8,9	4,4	500	119,30
HERG'S	148-42	767,40	553	418	291	27	147,5	42	10,1	5,2	500	119,30
HERG'S	148-50	799,20	597	451	314	35	147,5	50	10,9	5,4	650	121,30
HERG'S	148-58	823,80	641	484	337	43	147,5	58	11,6	5,6	650	121,30
HERG'S	175-42	864,50	652	492	343	27	175,2	42	12	6,1	650	121,30
HERG'S	175-50	896,10	705	532	371	35	175,2	50	12,9	6,4	650	121,30
HERG'S	175-58	920,90	757	572	398	43	175,2	58	13,7	6,6	800	125,70
HERG'S	203-50	952,50	813	614	428	35	202,9	50	14,9	7,3	800	125,70
HERG'S	203-58	977,20	873	659	459	43	202,9	58	15,9	7,7	900	129,00

▶ Pronta consegna

Termostati p.208-209

## ESECUZIONI DI SERIE

Colore bianco sablé SB9016

Tolleranze ± 3mm - Valvola di sfianto ø 1/8"

PRESSIONE MASSIMA D'ESERCIZIO 4 BAR

## ESECUZIONI A RICHIESTA

Verniciatura in una tinta della tabella colori

Brem con fissaggi colorati +15/25%

Versione elettrica e.Herg's, pag. 235

## ATTACCHI DI SERIE

REG ø 1/2"

A richiesta attacchi ø 3/8"

Attacchi speciali, pag. 279

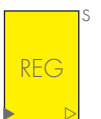

INTERASSE ATTACCHI

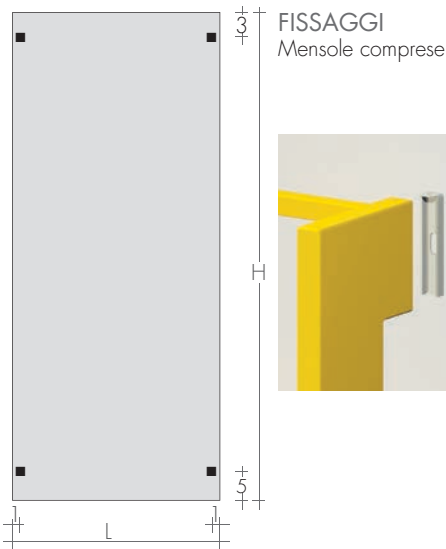
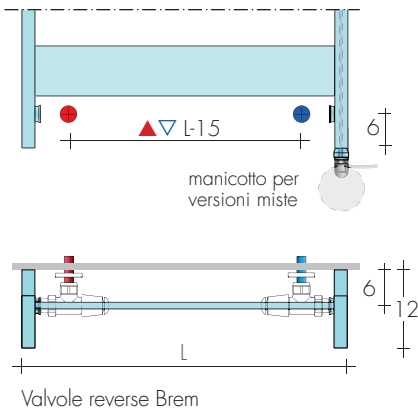

VALVOLE CONSIGLIATE

KIT VALVOLE CROMATE comprende:

- n°2 Valvole con codoli
- n°2 Raccordi (per multistrato ø16 e rame ø12 e 14)
- n°2 Rosette tonde cromo ø 48, foro ø16

FINITURE SPECIALI

pag. 267

Finiture Oro, Bronzo, Nickel spazzolato per 2 valvole

KIT Raccordi NICKEL spazz. suppl.Art. RN 28,20€

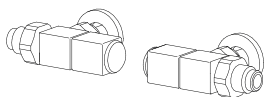

KIT VALVOLE mod. QUADRA REVERSE  
pag.271 Art. KQR 166,80€  
Colore tabella BREM supplemento 49,50€

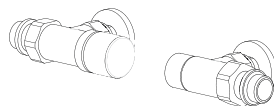

KIT VALVOLA CYL termostattabile REVERSA  
pag.273 Art. KCR 138,80€  
Colore tabella BREM supplemento 49,50€

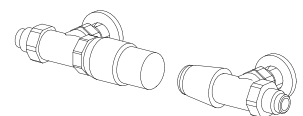

KIT VALVOLE TON REVERSE con Testa TERMO-  
STATICA, pag.269 Art. KTR 176,20€

design Luigi Brebbia

L'elemento scaldante HOOK è ideale dove le esigenze di spazio impongono di sfruttare

ogni centimetro per risolvere la richiesta di appendere e scaldare indumenti. HOOK si

installa in qualsiasi ambiente e nelle versioni multiple, può riscaldare anche la sala bagno.

LAME

## DIMENSIONI

Larghezze: 9 / 19 / 29 cm  
 Altezze: 180 / 210 cm  
 Profondità: 5,5/9 cm  
 Sporgenza dal muro: 9,5/13 cm



APPENDINI mod. HK, inclusi di serie e saldati sul calorifero

COLORI STANDARD:

- bianco sablé SB 9016
- grigio mica SB 7039
- nero mica SB 9005
- nel colore del radiatore

COLORI della tabella Brem diverso dal radiatore Supplemento 49,00€

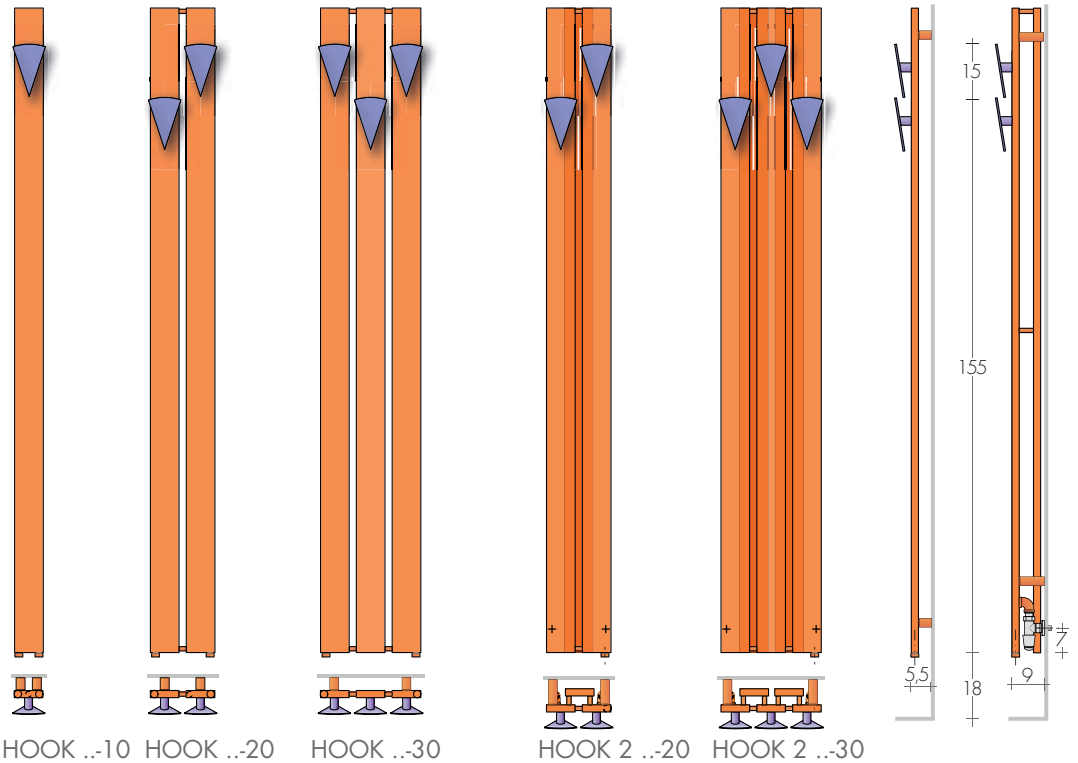

## MODELLO

MODELLO	HL cm	Bianco di serie sablé SB 9016 €	EN 442			▲ ▼ int.att. cm	Altezza H cm	Larghezza L cm	Profondità cm	Peso M Kg	Volume V dm³	VERSIONI MISTE con Resistenza e manico Watt €	
			Δt 50 K watt	Δt 40 K watt	Δt 30 K watt								
HOOK	180-10	502,10	197	148	102	5	180	9	6	4,1	2,4	*250	93,60
HOOK	180-20	689,10	378	284	197	15	180	19	6	8,2	4,7	400	117,20
HOOK	180-30	876,50	543	408	282	25	180	29	6	12,3	7,1	500	119,30
HOOK	210-10	518,60	230	173	120	5	210	9	6	4,8	2,7	*250	93,60
HOOK	210-20	705,90	441	331	229	15	210	19	6	9,5	5,5	400	117,20
HOOK	210-30	893,00	632	475	329	25	210	29	6	14,3	8,2	650	121,30
HOOK-2	180-20	867,70	511	384	266	15	180	19	10	12,3	7,1	500	119,30
HOOK-2	180-30	890,00	650	447	338	25	180	29	10	20,4	11,8	650	121,30
HOOK-2	210-20	1032,60	595	488	309	15	210	19	10	14,3	8,2	650	121,30
HOOK-2	210-30	1054,60	850	638	442	25	210	29	10	23,8	13,7	900	129,00

▶ Pronta consegna

\*Mod. HOOK..-10 solo con valvola mista sinistra p.207  
 Termostati p.208-209

APPENDINI in alternativa a quello di serie senza supplemento



APPENDINO modello PO



APPENDINO modello ARO

## ESECUZIONI DI SERIE

Colore bianco sablé SB9016 fissaggi bianchi  
 Tolleranze ± 3mm - Valvola di sfianto ø 1/8"  
 PRESSIONE MASSIMA D'ESERCIZIO 4 BAR

## ESECUZIONI A RICHIESTA

Verniciatura tabella colori Brem +15/25%  
 Pomoli ad altezze diverse, senza supplemento  
 Versione elettrica e.Hook, pag.236

## ATTACCHI DI SERIE

EG ø 1/2"  
 A richiesta attacchi ø 3/8"  
 Attacchi speciali, pag.279



INTERASSE ATTACCHI

HOOK ...-10

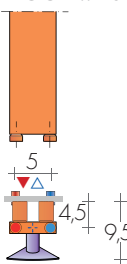

HOOK ...-20 - HOOK ...-30

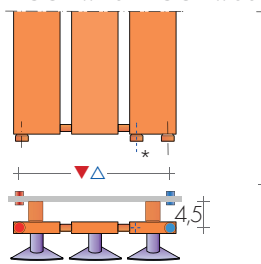

\*R.E.  
Resistenza  
Elettrica

HOOK 2...-20 - HOOK 2...-30

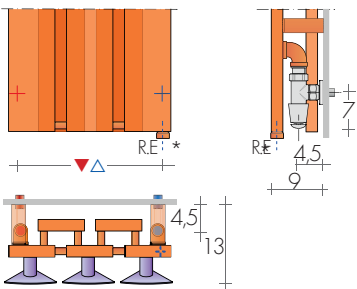

Di serie attacchi sul retro, con valvole reverse

VALVOLE per Attacchi sul retro Mod. HOOK2..

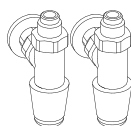

KIT VALVOLE mod. TON REVERSE pag.269

Art. KVR 120,00€

KIT VALVOLE mod. TON REVERSE con testa TERMOSTATICA

Art. KTR 176,20€

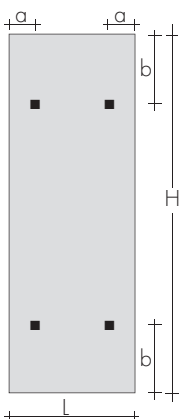

FISSAGGI

Mensole comprese  
HOOK Art. B35  
HOOK-2 Art. B70

Modello	a cm	b cm
HOOK ...-10	1,8	4
HOOK ...-20	4	4
HOOK ...-30	4	4
HOOK-2...-20	2,2	20
HOOK-2...-30	2,2	20

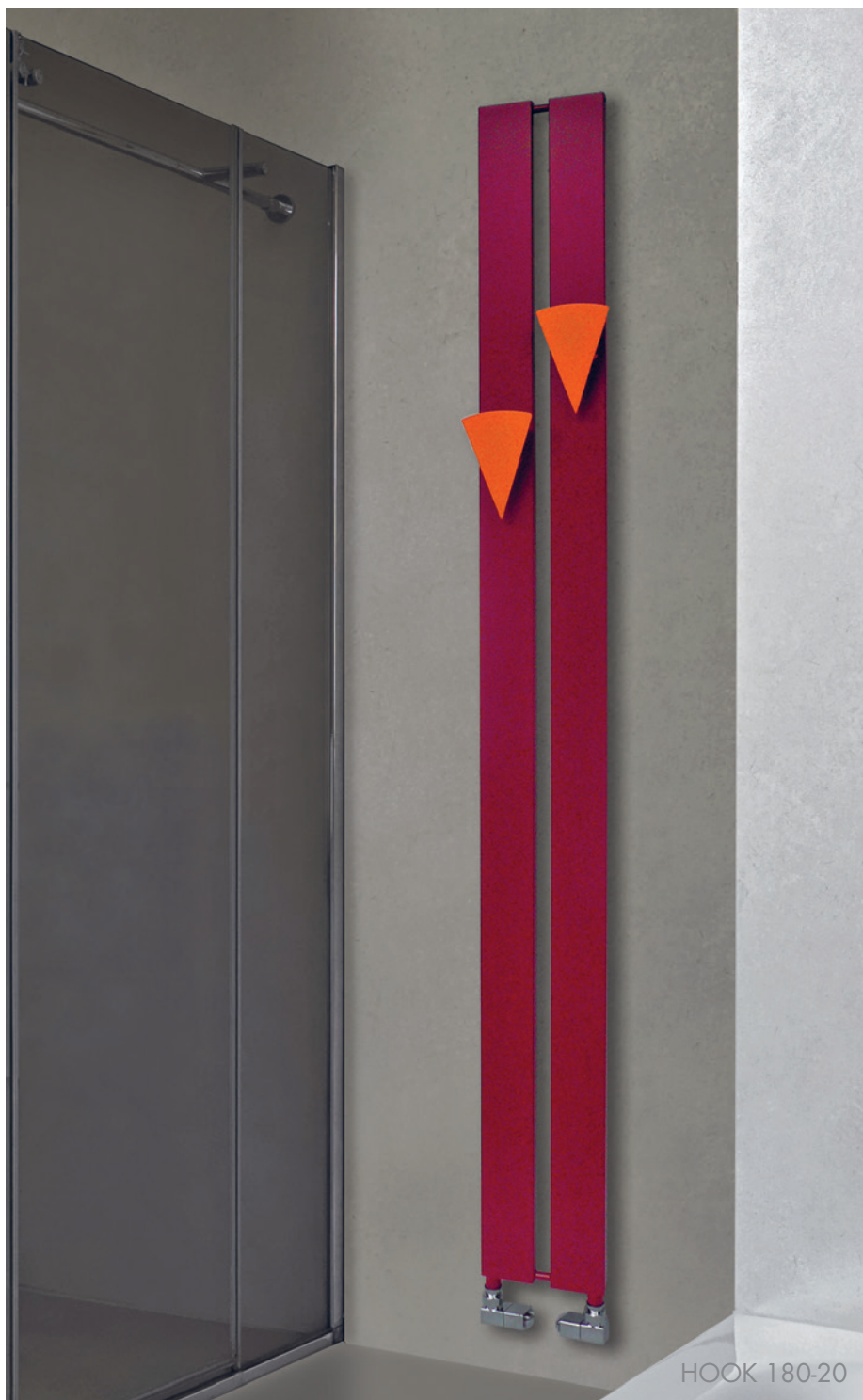

HOOK 180-20

VALVOLE CONSIGLIATE

KIT VALVOLE CROMATE comprende:

- n°2 Valvole con codoli
- n°2 Raccordi (per multistrato ø16 e rame ø12 e 14)
- n°2 Rosette tonde cromo ø 48, foro ø16

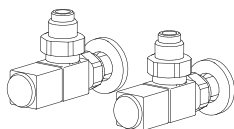

KIT VALVOLE QUADRA a SQUADRA pag.271

Art. KQS 166,80€  
supplemento 49,50€

Colore tabella BREM

FINITURE SPECIALI

pag. 267

Finiture Oro, Bronzo, Nickel spazzolato per 2 valvole  
KIT Raccordi NICKEL spazz. suppl.Art. RN 28,20€

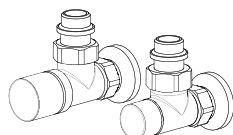

KIT VALVOLE CYL termostattabile a SQUADRA pag.273

Art. KCS 138,80€  
supplemento 49,50€

Colore tabella BREM

ATTACCHI REMOTI

Art. REM 37,60€

Attacchi remoti sul retro: interasse ▲▼ L-8cm  
Valvole REMOTE pag. 274

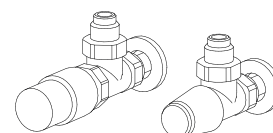
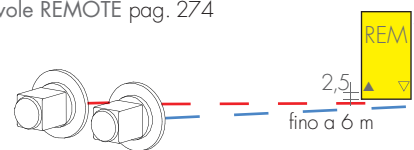

KIT VALVOLE TON a SQUADRA con Testa TERMOSTATICA, pag.269

Art. KTS 176,20€

design Davide Brembilla

KUO rievoca con originalità il formalismo giapponese e la sua essenzialità.

La purezza formale è ottenuta da una piastra piatta ai cui lati sono sovrapposti elementi

verticali, che delimitano lo spazio dando snellezza e continuità verso l'alto.

## DIMENSIONI

Larghezze: 25/35/42 cm  
 Altezze: 110/140/180 cm  
 Profondità: 8 cm  
 Sporgenza: dal muro 12 cm

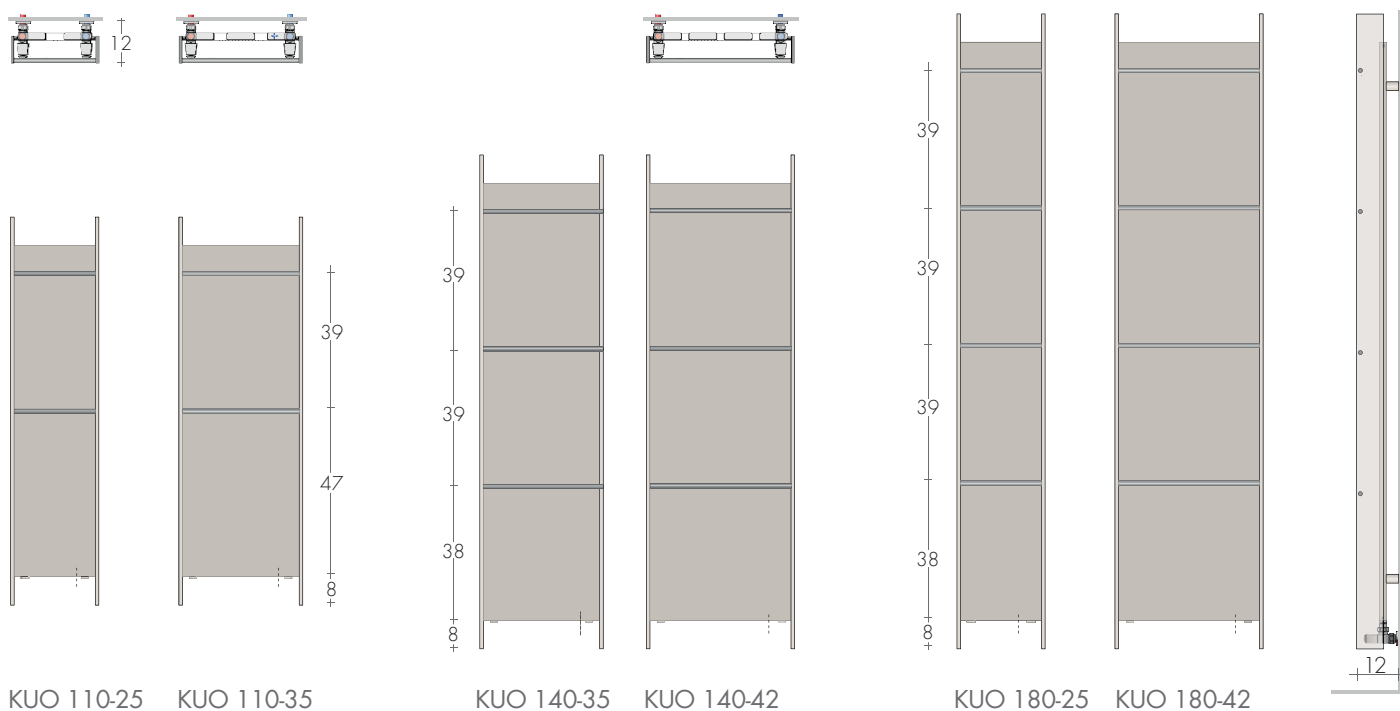

## MODELLO '25

	HL cm	Bianco di serie sablé SB 9016 €	Δt 50 K watt	EN 442 Δt 40 K watt	Δt 30 K watt	▲ ▼ int.att. cm	Altezza H cm	Larghezza L cm	Peso M Kg	Volume V dm <sup>3</sup>	VERSIONI MISTE con Resistenza e manicotto Watt €	
KUO	110-25	527,70	409	310	216	18	110	25	8,2	3,8	400	117,20
KUO	110-35	593,50	529	401	279	28	110	35	10,1	4,5	500	119,30
KUO	140-25	603,80	527	399	278	18	140	25	10,6	5,0	500	119,30
KUO	140-35	692,20	678	513	357	28	140	35	13,1	5,8	650	121,30
KUO	140-42	819,90	823	623	434	35	140	42	16,4	8,6	800	125,70
KUO	180-25	755,20	684	518	361	18	180	25	13,8	6,4	650	121,30
KUO	180-35	904,80	877	664	462	28	180	35	17,0	7,5	900	129,00
KUO	180-42	941,30	1064	806	561	35	180	42	21,2	11,1	1200	136,70

► Pronta consegna

Termostati p.208-209

## ESECUZIONI DI SERIE

Colore bianco sablé SB9016 fissaggi B35  
 Tolleranze ± 3mm - Valvola di sfianto ø 1/8"  
 PRESSIONE MASSIMA D'ESERCIZIO 4 BAR

## ESECUZIONI A RICHIESTA

Verniciatura in una tinta della tabella colori  
 Brem con fissaggi colorati B35 +15/25%  
 Versione elettrica e.Kuo, pag.239

## ATTACCHI DI SERIE

EG ø 1/2"  
 A richiesta attacchi ø 3/8"  
 Attacchi speciali, pag.279



INTERASSE ATTACCHI

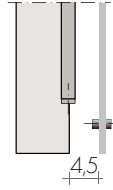
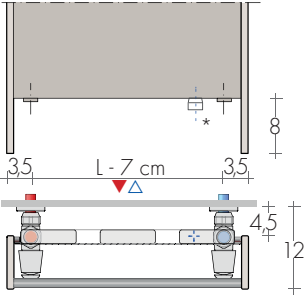

VERSIONI MISTE

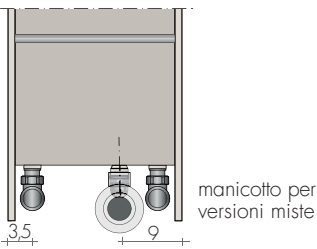

\*R.E.  
Resistenza  
Elettrica

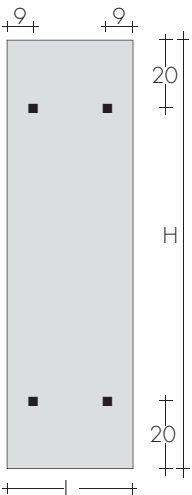

FISSAGGI  
Mensole B35 comprese



KUO 180-25

VALVOLE CONSIGLIATE

KIT VALVOLE CROMATE comprende:

- n°2 Valvole con codoli
- n°2 Raccordi (per multistrato ø16 e rame ø12 e 14)
- n°2 Rosette tonde cromo ø 48, foro ø16

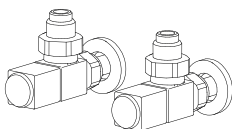

KIT VALVOLE QUADRA a SQUADRA  
pag.271 Art. KQS 166,80€  
Colore tabella BREM supplemento 49,50€

FINITURE SPECIALI

pag. 267  
Finiture Oro, Bronzo, Nickel spazzolato per 2 valvole  
KIT Raccordi NICKEL spazz. suppl.Art. RN 28,20€

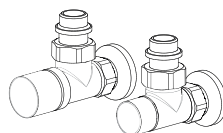

KIT VALVOLE CYL termostattabile a SQUADRA  
pag.273 Art. KCS 138,80€  
Colore tabella BREM supplemento 49,50€

ATTACCHI REMOTI

Art. REM 37,60€  
Interasse attacchi sul retro: ▲▼ EG  
Valvole REMOTE pag. 274

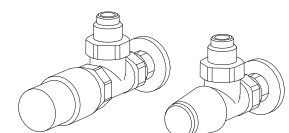
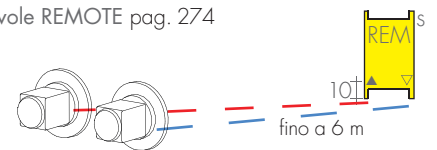

KIT VALVOLE TON a SQUADRA con Testa TERMO-  
STATICA, pag.269 Art. KTS 176,20€

design Davide Brembilla

Lame rette, compatte e di grande spessore tagliano l'uniformità della parete, concepiti

sono una nuova idea di scaldasalviette con cui animare e disegnare la parete del bagno.

La forma, insolita e assolutamente inattesa, sorprende come una scultura.

## DIMENSIONI

Larghezza: 43,0 / 49,5 cm

Altezza: 190 / 210 cm

Profondità: 8 cm

Sporgenza: 9,5 cm

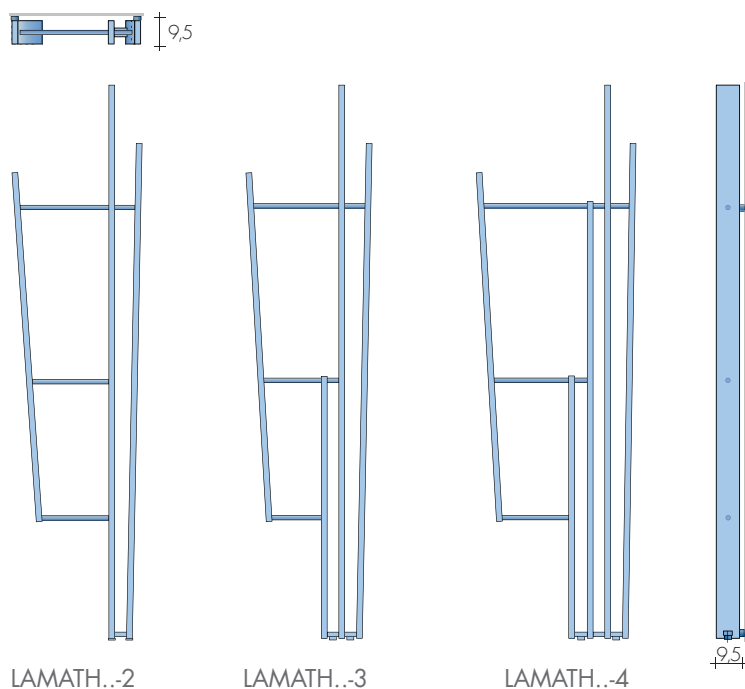

MODELLO	HL cm	Bianco di serie sablé SB 9016 €	EN 442			▲ ▽ int.att. cm	Altezza H cm	Larghezza L cm	Peso M Kg	Volume V dm³	VERSIONI MISTE con Resistenza e manicotto	
			Δt 50 K watt	Δt 40 K watt	Δt 30 K watt						Watt	€
LAMATH	190-2	645,90	467	345	243	6	190	43	14,4	6,3	400	117,20
LAMATH	190-3	765,50	555	410	289	6	190	43	17,2	7,5	500	119,30
LAMATH	190-4	885,60	700	517	364	12	190	49,5	21,7	9,4	650	121,30
LAMATH	210-2	691,60	525	387	273	6	210	43	16,3	7,1	500	119,30
LAMATH	210-3	827,80	642	474	334	6	210	43	19,9	8,6	650	121,30
LAMATH	210-4	963,90	807	596	420	12	210	49,5	25,0	10,9	800	125,70

▶ Pronta consegna

Termostati p.208-209

## ESECUZIONI DI SERIE

Colore bianco sablé SB9016 mensola B15  
Tolleranze ± 3mm - Valvola di sfianto ø 1/8"  
PRESSIONE MASSIMA D'ESERCIZIO 4 BAR

## ESECUZIONI A RICHIESTA

Verniciatura in una tinta della tabella colori  
Brem (con fissaggi B15 colorati) +15/25%  
Versione elettrica e.Lamath, pag.240

## ATTACCHI DI SERIE

EG ø 1/2"  
A richiesta attacchi ø 3/8"  
Attacchi speciali, pag.279



INTERASSE ATTACCHI

LAMATH...2



LAMATH...3

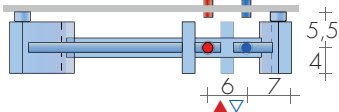

LAMATH...4

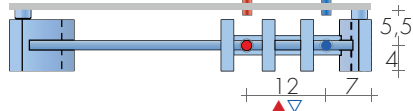

VERSIONI MISTE\*

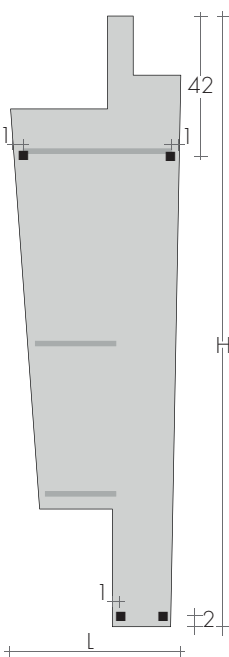
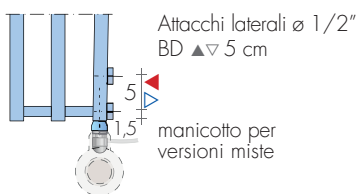

**FISSAGGI**  
Mensole B15 comprese B27 con attacchi remoti e B35 Lame ...2



VALVOLE CONSIGLIATE

KIT VALVOLE CROMATE comprende:

- n°2 Valvole con codoli
- n°2 Raccordi (per multistrato ø16 e rame ø12 e 14)
- n°2 Rosette tonde cromo ø 48, foro ø16

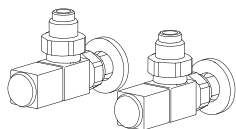

KIT VALVOLE QUADRA a SQUADRA  
pag.271 Art. KQS 166,80€  
Colore tabella BREM supplemento 49,50€

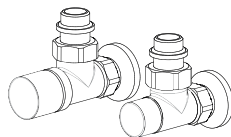

KIT VALVOLE CYL termostattabile a SQUADRA  
pag.273 Art. KCS 138,80€  
Colore tabella BREM supplemento 49,50€

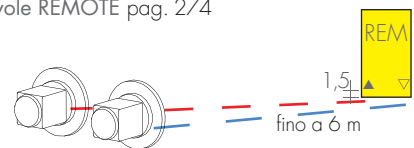

FINITURE SPECIALI pag. 267  
Finiture Oro, Bronzo, Nickel spazzolato per 2 valvole  
KIT Raccordi NICKEL spazz. suppl.Art. RN 28,20€

ATTACCHI REMOTI Art. REM 37,60€  
Interasse attacchi sul retro: ▲▽ EG  
Valvole REMOTE pag. 274

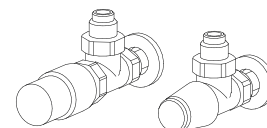

KIT VALVOLE TON a SQUADRA con Testa TERMO-  
STATICA, pag.269 Art. KTS 176,20€

design Davide Brembilla

Lame rette, compatte e di grande spessore tagliano l'uniformità della parete, concepiscono una nuova idea di scaldaserviette con cui animare e disegnare la parete del bagno.

La forma, insolita e assolutamente inattesa, sorprende come una scultura.

La forma, insolita e assolutamente inattesa, sorprende come una scultura.

## DIMENSIONI

Larghezza: 30 / 36 cm

Altezza: 190 / 210 cm

Profondità: 14,5 cm

Sporgenza: 15,5 cm

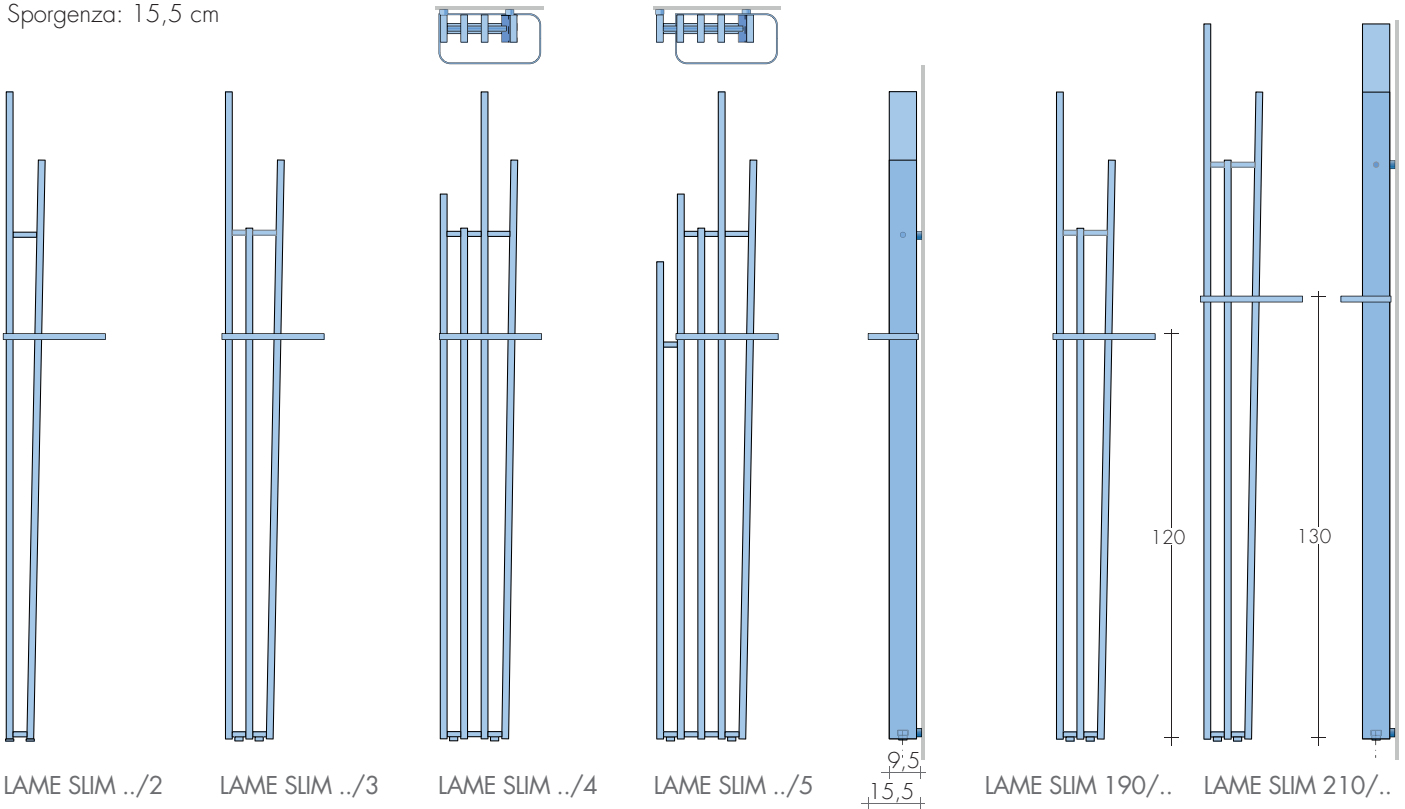

## MODELLO

MODELLO	H-L cm	Bianco di serie sablé SB 9016 €	EN 442			▲▼ int.att. cm	Altezza H cm	Larghezza L cm	Peso M Kg	Volume V dm <sup>3</sup>	VERSIONI MISTE con Resistenza e manicotto	
			Δt 50 K watt	Δt 40 K watt	Δt 30 K watt						Watt	€
LAME Slim	190/2	636,70	350	258	182	6	190	30	10,8	4,7	400	117,20
LAME Slim	190/3	764,80	496	366	258	6	190	30	15,4	6,7	500	119,30
LAME Slim	190/4	892,70	652	481	339	12	190	30	20,2	8,8	650	121,30
LAME Slim	190/5	1033,10	788	582	410	18	190	36	24,4	10,6	800	125,70
LAME Slim	210/2	674,30	389	287	202	6	210	30	12,0	5,2	400	117,20
LAME Slim	210/3	820,30	554	409	288	6	210	30	17,2	7,5	500	119,30
LAME Slim	210/4	965,80	730	539	380	12	210	30	22,6	9,9	800	125,70
LAME Slim	210/5	1124,40	885	653	460	18	210	36	27,4	11,9	900	129,00

▶ Pronta consegna

Termostati p.208-209

## ESECUZIONI DI SERIE

Colore bianco sablé SB9016 mensola B15  
Tolleranze ± 3mm - Valvola di sfianto ø 1/8"  
PRESSIONE MASSIMA D'ESERCIZIO 4 BAR

## ESECUZIONI A RICHIESTA

Verniciatura in una tinta della tabella colori  
Brem con fissaggi B15 colorati +15/25%  
Versione elettrica eLame Slim, p.242

## ATTACCHI DI SERIE

EG ø 1/2"  
A richiesta attacchi ø 3/8"  
Attacchi speciali, pag.279



INTERASSE ATTACCHI

LAME SLIM ../2

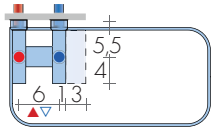

LAME SLIM ../3

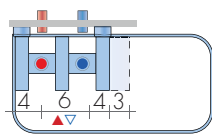

LAME SLIM ../4

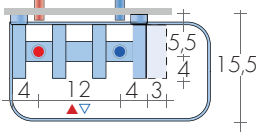

LAME SLIM ../5

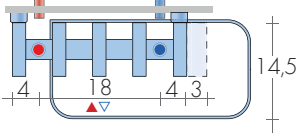

VERSIONI MISTE

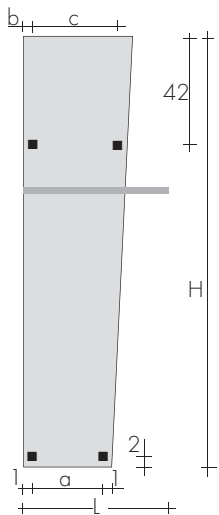
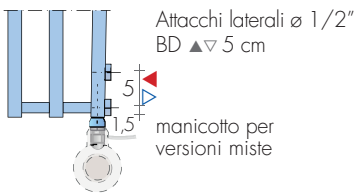

**FISSAGGI**  
Mensole B15 comprese,  
B27 con attacchi remoti  
e B35 lame ../2

Mod.	n° tubi	a cm	b cm	c cm
2	6	1	9	15
3	12	1	21	21
4	18	1	21	21
5	24	7	21	21



LAME SLIM 190/3

VALVOLE CONSIGLIATE

KIT VALVOLE CROMATE comprende:

- n°2 Valvole con codoli
- n°2 Raccordi (per multistrato ø16 e rame ø12 e 14)
- n°2 Rosette tonde cromo ø 48, foro ø16

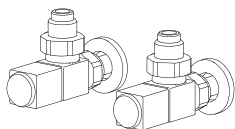

KIT VALVOLE QUADRA a SQUADRA

pag.271 Art. KQS 166,80€  
Colore tabella BREM supplemento 49,50€

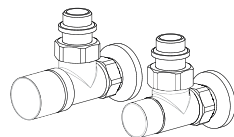

KIT VALVOLE CYL termostattabile a SQUADRA

pag.273 Art. KCS 138,80€  
Colore tabella BREM supplemento 49,50€

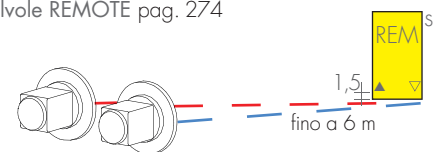

ATTACCHI REMOTI Art. REM 37,60€

Interasse attacchi sul retro: ▲▽ EG

Valvole REMOTE pag. 274

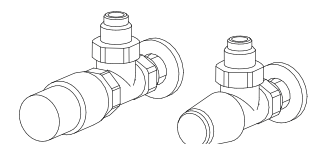

KIT VALVOLE TON a SQUADRA con Testa TERMO-STATICA, pag.269 Art. KTS 176,20€



# CrossFRAME INDEX

CALORIFERI A CORNICI

## COLLEZIONE CALORIFERI

	pag.
CROSS-Q	44
CROSS-G	46
CROSS-V	50

## COLLEZIONE SCALDASALVIETTE

	pag.
ALIS-ONE	52
ASYMM-ASYMP	54
CROSS	56
CROSS-Q	60
CROSS-FO/BIC	62
CROSS-CROM	63
CROSS-R	66
CROSS-RV	68
ESSEN	70
FIT	72
FREE	74
KORE PLUS	76
PIT	78
QUAR	80
VISION	82



# CROSS-Q A QUADRI SOVRAPPOSTI

PREZZI DAL 01.03.2026 +5%

design Luigi Brembilla

Tubi rettangolari di grandi dimensioni, diversamente assiemati, portano a CROSS-Q.

Angoli retti, rigide forme geometriche di quadri e rettangoli, si sovrappongono e si

intersecano componendo variamente un calorifero innovativo.

## DIMENSIONI

Larghezze 48/56/64/100/116 cm

Altezze 170/186/202/226/230 cm

Profondità 6 /7 cm

Sporgenza dal muro 9,5 cm

DISEGNI TECNICI a richiesta

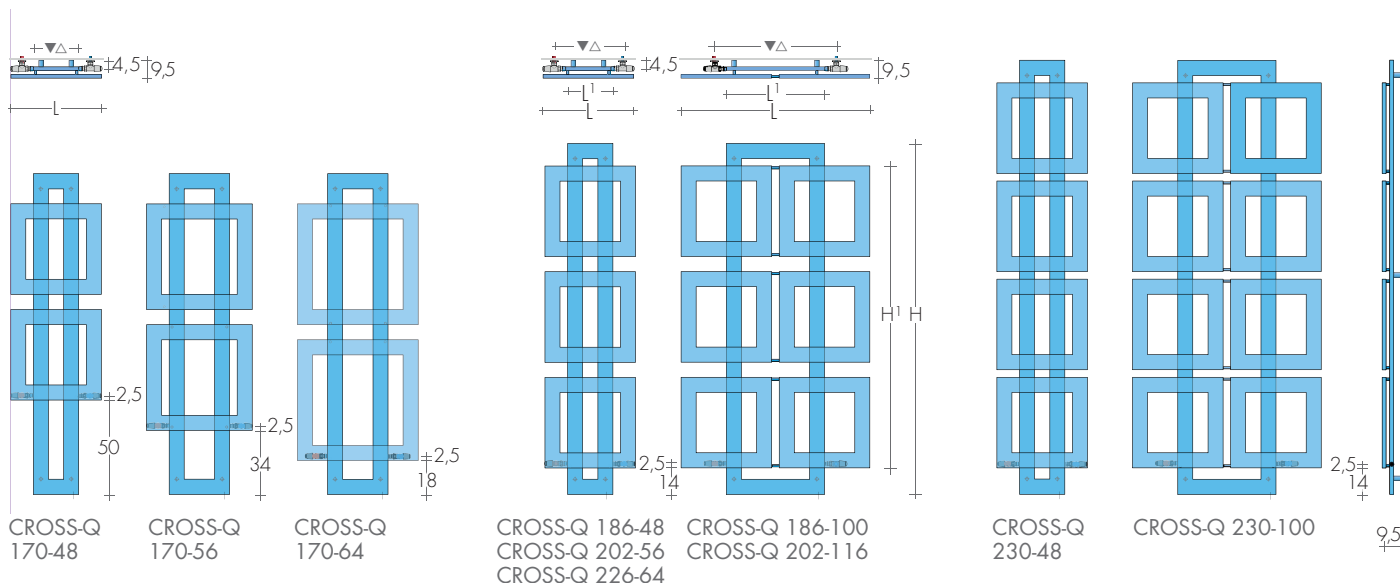

## MODELLO'25

MODELLO'25	HxL cm	Bianco di serie sablé SB 9016 €	EN 442			▲ ▼ int.att. cm	Altezza H (H1) cm	Larghezza L (L1) cm	Peso M Kg	Volume V dm³	VERSIONI MISTE con Resistenza e manicotto Watt €	
			Δt 50K watt	Δt 40K watt	Δt 30K watt						Watt	€
CROSS-Q	170-48	1110,90	711	537	374	37	170 (104)	48 (24)	14,2	8,8	650	121,30
CROSS-Q	170-56	1152,15	795	600	418	45	170 (120)	56 (32)	15,9	9,9	800	125,70
CROSS-Q	170-64	1190,15	863	652	454	45	170 (136)	64 (32)	17,2	10,7	900	129,00
CROSS-Q	186-48	1169,80	894	675	470	37	186 (160)	48 (24)	18,7	11,3	900	129,00
CROSS-Q	186-100	1904,00	1446	1092	761	65	186 (160)	100 (52)	30,2	18,3	1500	146,90
CROSS-Q	202-56	1227,30	1026	775	557	45	202 (176)	56 (32)	22,1	13,4	1200	136,70
CROSS-Q	202-116	2005,00	1677	1266	892	65	202 (176)	116 (52)	35,4	21,5	1500	146,90
CROSS-Q	226-64	1285,70	1174	886	635	45	226 (200)	64 (32)	25,2	15,3	1200	136,70
CROSS-Q	230-48	1410,30	1138	859	593	37	230 (204)	48 (24)	24,0	14,6	1200	136,70
CROSS-Q	230-100	2381,40	1830	1382	964	65	230 (204)	100 (52)	39,1	23,7	-	-

Termostati p.208-209

## ESECUZIONI DI SERIE

Colore bianco sablé SB9016 mensole B35  
Tolleranze ± 3mm - Valvola di sfianto ø 1/8"  
PRESSIONE MASSIMA D'ESERCIZIO 4 BAR

## ESECUZIONI A RICHIESTA

Verniciatura in una tinta della tabella colori  
Brem con fissaggi B35 colorati +15/25%  
Versione elettrica e.Cross-Q, pag.221

## ATTACCHI DI SERIE

REG ø 1/2"  
A richiesta attacchi ø 3/8"  
Attacchi speciali, pag.278



INTERASSE ATTACCHI  
CROSS-Q

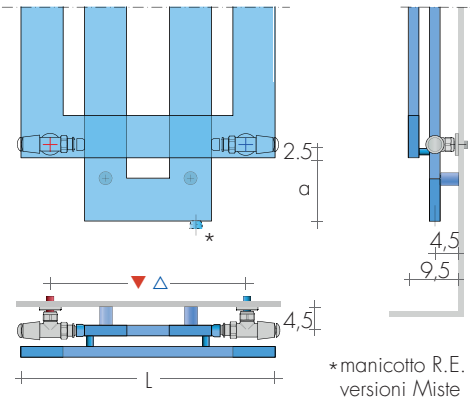

- CROSS 170-48 a=50
- CROSS 170-56 a=34
- CROSS 170-48 a=18
- CROSS da 186... a=14

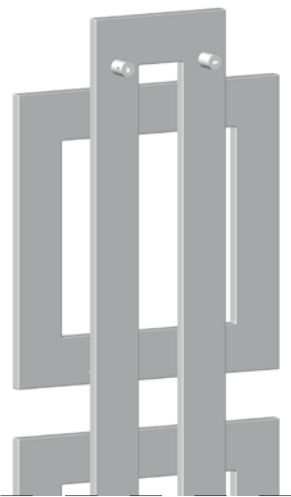

FISSAGGI  
Mensole B35  
comprese



CROSS-Q 186-100

VALVOLE CONSIGLIATE

KIT VALVOLE CROMATE comprende:

- n°2 Valvole con codoli
- n°2 Raccordi (per multistrato ø16 e rame ø12 e 14)
- n°2 Rosette tonde cromo ø 48, foro ø16

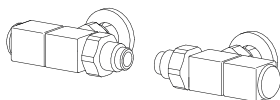

KIT VALVOLE QUADRA REVERSE  
pag. 271 Art. KQR 166,80€  
Colore tabella BREM supplemento 49,50€

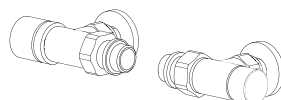

KIT VALVOLE CYL termostattabile REVERSA  
pag. 273 Art. KCR 138,80€  
Colore tabella BREM supplemento 49,50€

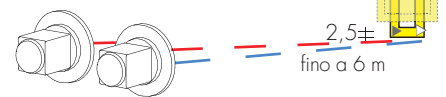

FINITURE SPECIALI pag. 267  
Finiture Oro, Bronzo, Nickel spazzolato per 2 valvole  
KIT Raccordi NICKEL spazz. suppl. Art. RN 28,20€

ATTACCHI REMOTI Art. REM 37,60€  
Interasse attacchi sul retro ▲▽ L<sup>1</sup> - 6 cm  
VALVOLE REMOTE pag. 274

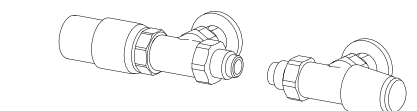

KIT VALVOLE TON REVERSE con TESTA TERMO-  
STATICA, pag. 269 Art. KTR 176,20€

*design Luigi Brebbia*

Il calorifero CROSS-G, realizzato con solo 2 cm di profondità, è costituito da una grande

cornice rettangolare, elegante e protagonista, arricchita da tubi verticali e lamelle radianti,

per ottenere alte rese. Il suo particolare design lo rende adatto all'utilizzo in ogni ambiente.

## MODELLO CGH con tubi radianti verticali

Altezze: da 51 a 241 cm  
Larghezze: da 27 a 99 cm  
Profondità: 2 cm  
Sporgenza dal muro: 5,5 cm

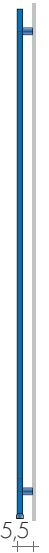
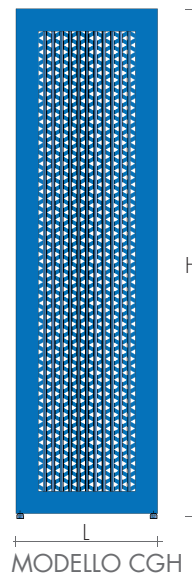
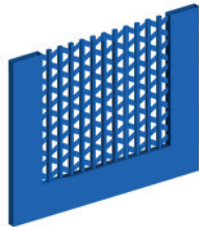

## MODELLO CGV con tubi radianti orizzontali

Altezze: da 27 a 99 cm  
Larghezze: da 51 a 221 cm  
Profondità: 2 cm  
Sporgenza dal muro: 5,5 cm

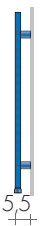
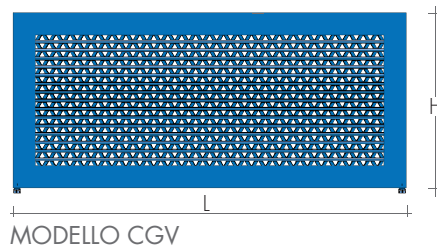
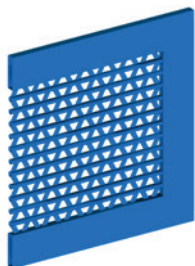

### ESECUZIONI DI SERIE

Colore bianco sablé SB9016 mensole B35  
Tolleranze  $\pm 3$ mm - Valvola di sfianto  $\varnothing 1/8''$   
PRESSIONE MASSIMA D'ESERCIZIO 4 BAR

### ESECUZIONI A RICHIESTA

Verniciatura in una tinta della tabella colori  
Brem con fissaggi B35 colorati +15/25%  
Versione elettrica, pag.220

### ATTACCHI DI SERIE

EG  $\varnothing 1/2''$   
A richiesta attacchi  $\varnothing 3/8''$   
Attacchi speciali, pag. 278



INTERASSE ATTACCHI

Di serie attacchi EG verticali  
A richiesta attacchi laterali, senza supplemento

MODELLO CGH

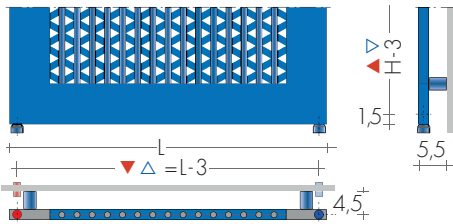

MODELLO CGV

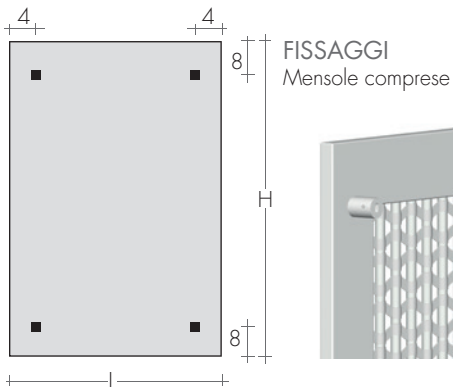
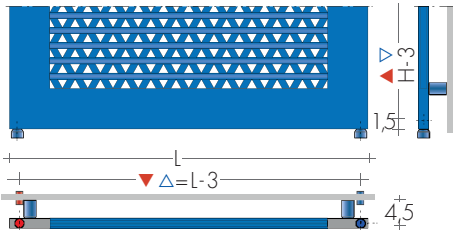

CrossFRAME

VALVOLE CONSIGLIATE

KIT VALVOLE CROMATE comprende:

- n°2 Valvole con codoli
- n°2 Raccordi (per multistrato ø16 e rame ø12 e 14)
- n°2 Rosette tonde cromo ø 48, foro ø16

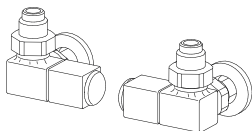

KIT VALVOLE QUADRA comando LATERALE  
pag. 271 Art. KQL 177,10€  
Colore tabella BREM supplemento 49,50€

FINITURE SPECIALI

pag. 267  
Finiture Oro, Bronzo, Nickel spazzolato per 2 valvole  
KIT Raccordi NICKEL spazz. suppl.Art. RN 28,20€

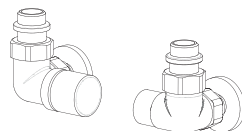

KIT VALVOLE CYL comando LATERALE  
pag. 273 Art. KCL 150,50€  
Colore tabella BREM supplemento 49,50€

ATTACCHI REMOTI

Art. REM 37,60€  
Interasse attacchi sul retro: ▲▼ L - 6cm  
VALVOLE REMOTE pag. 274

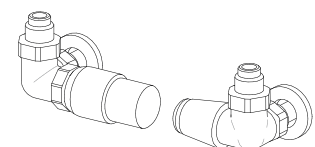
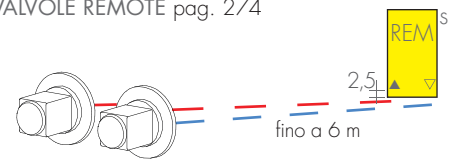

KIT VALVOLE TON comando LATERALE con testa  
TERMOSTATICA pag. 269 Art. KTL 188,60€

EN 442 Watt  $\Delta t$  50K ( $\Delta t$  40K =  $W \times 0,755$ ) - ( $\Delta t$  30K =  $W \times 0,526$ )

MODELLO	H cm i. a. ▲ ▽ cm	L cm	Lunghezze											
			27	33	39	45	51	57	63	69	75	81	87	93
CGH 51	€	538,80 170w	589,90 205w	640,90 240w	692,10 275w	743,10 310w	794,20 345w	845,30 380w	896,30 415w	947,40 450w	998,40 485w	1049,60 520w	1100,60 555w	1151,70 590w
CGH 71	€	599,40 234w	650,50 281w	701,60 329w	752,60 376w	803,70 424w	854,80 471w	905,80 518w	957,00 566w	1008,00 613w	1059,10 661w	1110,20 708w	1161,30 755w	1212,30 803w
CGH 91	€	660,00 297w	711,10 357w	762,20 417w	813,20 477w	864,40 537w	915,40 597w	966,50 656w	1017,60 716w	1068,70 776w	1119,70 836w	1170,80 896w	1221,90 956w	1272,90 1016w
CGH 161	€	872,10 519w	923,30 623w	974,30 726w	1025,40 830w	1076,50 933w	1127,60 1036w	1178,60 1140w	1229,80 1243w	1280,80 1347w	1331,90 1450w	1383,00 1554w	1434,00 1657w	1485,10 1760w
CGH 181	€	932,80 583w	983,90 699w	1035,00 814w	1086,00 930w	1137,20 1046w	1188,20 1162w	1239,20 1278w	1290,30 1394w	1341,40 1510w	1392,50 1626w	1443,50 1741w	1494,70 1857w	1545,70 1973w
CGH 191	€	963,10 614w	1014,20 736w	1065,20 859w	1116,40 981w	1167,40 1103w	1218,50 1225w	1269,60 1347w	1320,70 1469w	1371,70 1591w	1422,80 1713w	1473,90 1835w	1524,90 1957w	1576,10 2080w
CGH 201	€	993,40 646w	1044,50 774w	1095,60 903w	1146,60 1031w	1197,70 1159w	1248,80 1288w	1299,90 1416w	1350,90 1544w	1402,10 1673w	1453,10 1801w	1504,20 1929w	1555,30 2058w	1606,30 2186w
CGH 211	€	1023,80 678w	1074,80 812w	1125,90 947w	1176,90 1081w	1228,10 1216w	1279,10 1351w	1330,10 1485w	1381,30 1620w	1432,30 1754w	1483,40 1889w	1534,50 2023w	1585,60 2158w	1636,60 2292w
CGH 221	€	1054,00 710w	1105,10 850w	1156,20 991w	1207,30 1132w	1258,30 1273w	1309,50 1413w	1360,50 1554w	1411,60 1695w	1462,70 1836w	1513,70 1976w	1564,80 2117w	1615,80 2258w	1667,00 2399w
CGH 231	€	1084,30 741w	1135,40 888w	1186,50 1035w	1237,50 1182w	1288,70 1329w	1339,70 1476w	1390,80 1623w	1441,90 1770w	1493,00 1917w	1544,00 2064w	1595,20 2211w	1646,20 2358w	1697,20 2505w
CGH 241	€	1114,70 773w	1165,70 926w	1216,80 1079w	1267,90 1233w	1318,90 1386w	1370,00 1539w	1421,10 1692w	1472,20 1845w	1523,20 1999w	1574,40 2152w	1625,40 2305w	1676,50 2458w	1727,60 2611w

$\Delta t$  diversi da 50 K: consultare Dati tecnici Brem

## ORDINE

Indicare: il modello con altezza e larghezza in cm; l'attacco e il colore, solo se diversi dalla esecuzione di serie.  
es.: CGH 181 - 39, EG  $\emptyset$  1/2", SB 5002



## ESECUZIONI A RICHIESTA

Rese caloriche e prezzi per interpolazione:  
- lunghezze ogni 3 cm  
- altezze ogni 10 cm

Esecuzioni su misura ( $\pm 3$  mm)

Dimensioni oltre 3 m: a preventivo  
Altezze ogni 5 cm: misura superiore +10%

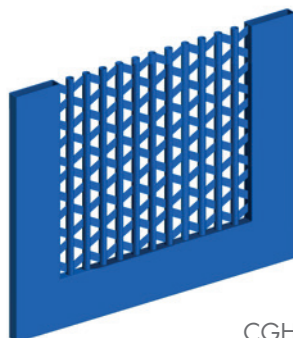

CGH

## VERSIONE DOPPIA CGDH

Si uniscono due Cross-CGH

Attacco di serie EG  $\emptyset$  1/2" (mandata e ritorno sulla parte anteriore) mensola B15.

Rese indicative CGDH: radiatore singolo x1,65

PREZZO CGDH CGH x 2 + 125,00€



EN 442 Watt  $\Delta t$  50K ( $\Delta t$  40K =  $W \times 0,755$ ) - ( $\Delta t$  30K =  $W \times 0,526$ )

MODELLO	i. a. ▲ ▽ cm	Lunghezze									
		51 48	71 68	91 88	101 98	121 118	141 138	161 158	181 178	201 198	221 218
CGV 27	€	538,80 176w	599,40 241w	660,00 306w	690,40 339w	751,00 404w	811,50 470w	872,10 535w	932,80 600w	993,40 666w	1054,00 731w
CGV 33	€	589,90 212w	650,50 290w	711,10 368w	741,40 407w	802,00 485w	862,70 563w	923,30 641w	983,90 720w	1044,50 798w	1105,10 876w
CGV 39	€	640,90 248w	701,60 339w	762,20 430w	792,40 475w	853,10 566w	913,70 657w	974,30 748w	1035,00 839w	1095,60 930w	1156,20 1021w
CGV 45	€	692,10 284w	752,60 387w	813,20 491w	843,60 543w	904,20 647w	964,80 751w	1025,40 854w	1086,00 958w	1146,60 1062w	1207,30 1166w
CGV 51	€	743,10 320w	803,70 436w	864,40 553w	894,60 611w	955,30 728w	1015,90 844w	1076,50 961w	1137,20 1078w	1197,70 1194w	1258,30 1311w
CGV 57	€	794,20 356w	854,80 485w	915,40 615w	945,70 679w	1006,30 809w	1066,90 938w	1127,60 1067w	1188,20 1197w	1248,80 1326w	1309,50 1456w
CGV 63	€	845,30 392w	905,80 534w	966,50 676w	996,80 747w	1057,50 890w	1118,00 1032w	1178,60 1174w	1239,20 1316w	1299,90 1458w	1360,50 1601w
CGV 69	€	896,30 428w	957,00 583w	1017,60 738w	1047,90 815w	1108,50 970w	1169,10 1125w	1229,80 1281w	1290,30 1436w	1350,90 1591w	1411,60 1746w
CGV 75	€	947,40 464w	1008,00 632w	1068,70 799w	1098,90 883w	1159,50 1051w	1220,20 1219w	1280,80 1387w	1341,40 1555w	1402,10 1723w	1462,70 1891w
CGV 81	€	998,40 500w	1059,10 680w	1119,70 861w	1150,10 952w	1210,70 1132w	1271,20 1313w	1331,90 1494w	1392,50 1674w	1453,10 1855w	1513,70 2036w
CGV 87	€	1049,60 536w	1110,20 729w	1170,80 923w	1201,10 1020w	1261,70 1213w	1322,40 1407w	1383,00 1600w	1443,50 1794w	1504,20 1987w	1564,80 2181w
CGV 93	€	1100,60 572w	1161,30 778w	1221,90 984w	1252,20 1088w	1312,80 1294w	1373,40 1500w	1434,00 1707w	1494,70 1913w	1555,30 2119w	1615,80 2326w
CGV 99	€	1151,70 608w	1212,30 827w	1272,90 1046w	1303,30 1156w	1363,80 1375w	1424,50 1594w	1485,10 1813w	1545,70 2032w	1606,30 2251w	1667,00 2471w

$\Delta t$  diversi da 50 K: consultare Dati tecnici Brem



### ESECUZIONI A RICHIESTA

Rese caloriche e prezzi per interpolazione:  
- altezze ogni 3 cm  
- lunghezze ogni 10 cm

Esecuzioni su misura ( $\pm 3$  mm)

Dimensioni oltre 3 m: a preventivo  
Misure ogni 5 cm: misura superiore +10%

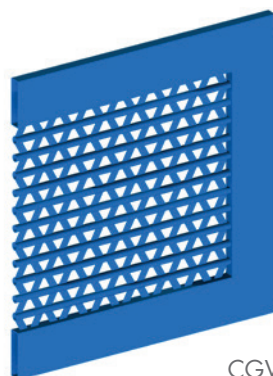

CGV



### VERSIONE DOPPIA CGDV

Si uniscono due Cross-CGV

Attacco di serie EG  $\varnothing$  1/2" (mandata e ritorno sulla parte anteriore), mensola B15.

Rese indicative CGDV: radiatore singolo x1,65

PREZZO CGDV CGV x 2 + 125,00€

design Luigi Brembilla

Tubi rettangolari di grandi dimensioni e rigide forme geometriche rettangolari

compongono un calorifero innovativo. CROSS-V rappresenta la linearità assoluta: un

rettangolo semplice o doppio, che completa e integra le variegate proposte di CROSS-Q.

## DIMENSIONI

Larghezze 24/52/80/104/144 cm  
Altezze 24/52/184/208/224 cm  
Profondità 2/8 cm  
Sporgenza dal muro 5,5/11,5 cm

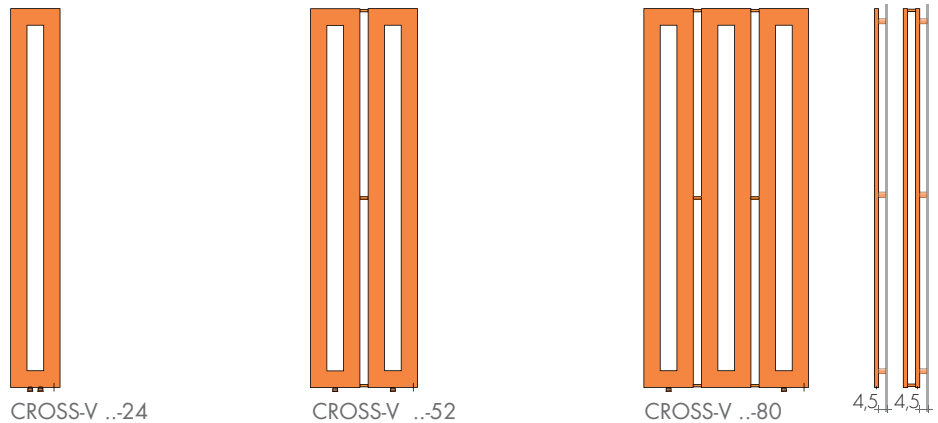
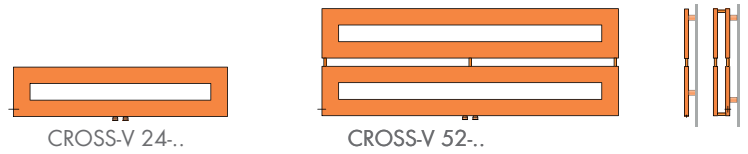
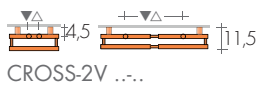

MODELLO	Bianco di serie sablé SB 9016		EN 442			▲ ▽ int.att. cm	Altezza		Profondità p cm	Peso M Kg	Volume V dm³	VERSIONI MISTE con Resistenza e manicotto	
	H-L cm	€	Δt 50K watt	Δt 40K watt	Δt 30K watt		H cm	L cm				Watt	€
CROSS-V 24-104	24-104	428,10	246	191	130	5	24	104	2	4,8	2,9	250	115,10
CROSS-V 24-144	24-144	540,60	334	259	176	5	24	144	2	6,6	4,0	300	116,10
CROSS-V 52-104	52-104	536,10	493	239	260	5	52	104	2	9,6	5,8	500	119,30
CROSS-V 52-144	52-144	689,50	669	307	353	5	52	144	2	13,2	8,0	650	121,30
CROSS-2V 24-104	24-104	815,10	429	362	226	5	24	104	8	9,7	5,9	400	117,20
CROSS-2V 24-144	24-144	1044,10	582	492	307	5	24	144	8	13,1	8,0	650	121,30
CROSS-2V 52-104	52-104	1018,60	857	430	452	5	52	104	8	19,2	11,6	900	129,00
CROSS-2V 52-144	52-144	1309,80	1164	552	614	5	52	144	8	26,4	16,0	1200	136,70
CROSS-V 184-24	184-24	519,00	422	311	223	5	184	24	2	8,3	5,0	400	117,20
CROSS-V 184-52	184-52	945,70	845	621	446	28	184	52	2	16,6	10,1	800	125,70
CROSS-V 184-80	184-80	1308,30	1267	932	669	56	184	80	2	24,9	15,1	1200	136,70
CROSS-V 208-24	208-24	541,30	475	350	251	5	208	24	2	9,3	5,7	500	119,30
CROSS-V 208-52	208-52	975,50	950	699	501	28	208	52	2	18,7	11,3	900	129,00
CROSS-V 208-80	208-80	1350,50	1426	1049	752	56	208	80	2	28	17,0	1500	146,90
CROSS-V 224-24	224-24	560,60	510	382	269	5	224	24	2	10	6,1	500	119,30
CROSS-V 224-52	224-52	999,20	1021	764	539	28	224	52	2	20	12,1	900	129,00
CROSS-V 224-80	224-80	1402,00	1531	1146	808	56	224	80	2	30	18,3	1500	146,90
CROSS-2V 184-24	184-24	986,30	735	560	388	5	184	24	8	16,6	10,0	800	125,70
CROSS-2V 184-52	184-52	1797,10	1470	1118	776	28	184	52	8	33,2	20,2	1500	146,90
CROSS-2V 208-24	208-24	1028,70	827	629	436	5	208	24	8	18,6	11,4	800	125,70
CROSS-2V 208-52	208-52	1853,30	1654	1259	873	28	208	52	8	37,4	22,6	1500	146,90

Termostati p.208-209

## VERSIONI MISTE modelli verticali con termostato

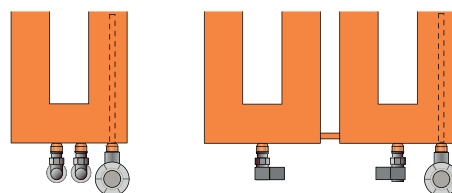

## ESECUZIONI DI SERIE

Colore bianco sablé SB9016 mensole B35  
Tolleranze ± 3mm - Valvola di sfizio ø 1/8"  
PRESSIONE MASSIMA D'ESERCIZIO 4 BAR

## ESECUZIONI A RICHIESTA

Verniciatura in una tinta della tabella colori  
Brem con fissaggi B35 colorati +15/25%  
Versione elettrica e.CROSS-V pag.220

## ATTACCHI DI SERIE

EG ø 1/2"  
A richiesta attacchi ø 3/8"  
Attacchi speciali, pag. 278



INTERASSE ATTACCHI EG 1/2"

Modelli orizzontali

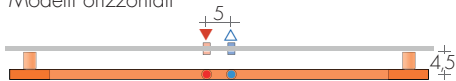

Modelli verticali

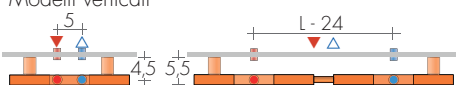

- Mod. L=24 ▼▲ 5 cm
- Mod. L=52 ▼▲ 28 cm
- Mod. L=80 ▼▲ 56 cm
- Mod. L=104 ▼▲ 5 cm
- Mod. L=144 ▼▲ 5 cm

ATTACCHI SUL RETRO ø 1/2" a richiesta

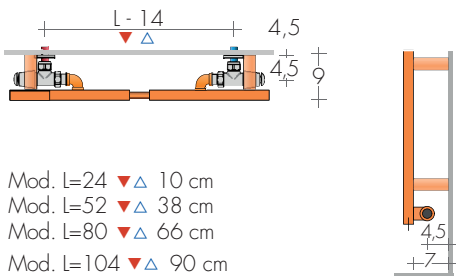

- Mod. L=24 ▼▲ 10 cm
- Mod. L=52 ▼▲ 38 cm
- Mod. L=80 ▼▲ 66 cm
- Mod. L=104 ▼▲ 90 cm
- Mod. L=144 ▼▲ 130 cm

A richiesta attacchi sul retro per valvole reverse:  
▲ ▼ L-14 cm      suppl. Art. REG 81,40€

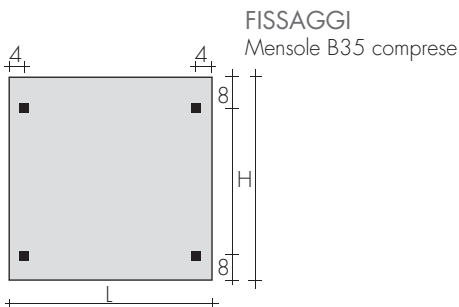

CROSS-2V 184-52

CrossFRAME

VALVOLE CONSIGLIATE

KIT VALVOLE CROMATE comprende:

- n°2 Valvole con codoli
- n°2 Raccordi (per multistrato ø16 e rame ø12 e 14)
- n°2 Rosette tonde cromo ø 48, foro ø16

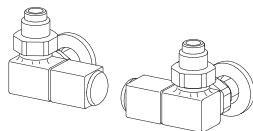

KIT VALVOLE QUADRA comando LATERALE  
pag. 271      Art. KQL    177,10€  
Colore tabella BREM      supplemento    49,50€

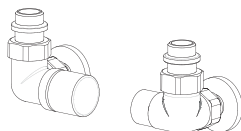

KIT VALVOLE CYL comando LATERALE  
pag. 273      Art. KCL    150,50€  
Colore tabella BREM      supplemento    49,50€

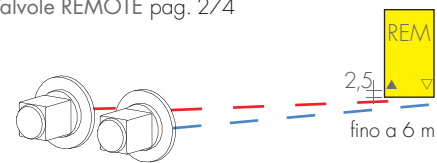

FINITURE SPECIALI      pag. 267  
Finiture Oro, Bronzo, Nickel spazzolato per 2 valvole  
KIT Raccordi NICKEL spazz. suppl.Art. RN 28,20€

ATTACCHI REMOTI      Art. REM    37,60€  
Interasse attacchi sul retro: ▲ ▼ L - 6cm  
Valvole REMOTE pag. 274

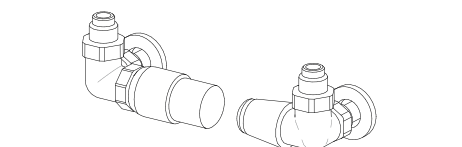

KIT VALVOLE TON comando LATERALE con testa TERMOSTATICA pag. 269      Art. KTL    188,60€

design Luigi Brebilla

La cornice rettangolare, elegante ed essenziale di ALIS, è arricchita da tubi orizzontali

zontali con funzione di scaldasalviette. Questi ultimi rievocano l'architettura degli

elementi frangisole e sono leggermente curvati e inclinati verso il basso.

## DIMENSIONI

Larghezze 51/91/121 cm

Altezze 56/70/98/126/154/182 cm

Profondità 6 cm

Sporgenza dal muro 9,5 cm



ALIS-ONE 56-51



ALIS-ONE 56-91



ALIS-ONE 56-121

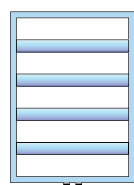
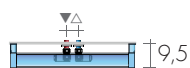

ALIS-ONE 70-51

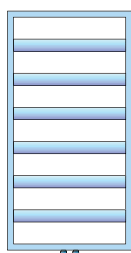

ALIS-ONE 98-51

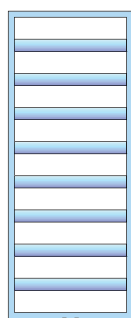

ALIS-ONE 126-51



ALIS-ONE 154-51

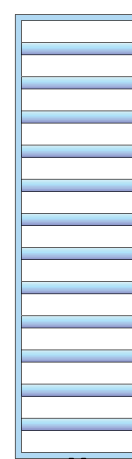

ALIS-ONE 182-51



MODELLO	H-L cm	Bianco di serie sablé SB 9016 €	$\Delta t$ 50K watt	EN 442		$\blacktriangle \nabla$ int. att. cm	Altezza H cm	Larghezza L cm	Peso M Kg	Volume V dm <sup>3</sup>	VERSIONI MISTE con Resistenza e manicotto	
				$\Delta t$ 40K	$\Delta t$ 30K						Watt	€
ALIS-ONE	56-51	488,00	311	237	166	5	56	51	6,4	3,3	300	116,10
ALIS-ONE	56-91	571,40	491	373	262	5	56	91	9,8	4,9	500	119,30
ALIS-ONE	56-121	634,00	626	476	334	5	56	121	12,3	6,1	650	121,30
ALIS-ONE	70-51	523,20	379	288	202	5	70	51	7,6	3,9	400	117,20
ALIS-ONE	98-51	593,60	513	390	273	5	98	51	10,2	5,1	500	119,30
ALIS-ONE	126-51	664,00	648	493	345	5	126	51	12,7	6,2	650	121,30
ALIS-ONE	154-51	734,40	783	595	417	5	154	51	15,2	7,4	800	125,70
ALIS-ONE	182-51	804,80	918	698	489	5	182	51	17,7	8,5	900	129,00

Dimensioni su misura a richiesta

Termostati p.208-209

## ESECUZIONI DI SERIE

Colore bianco sablé SB9016 mensola B35  
Tolleranze  $\pm 3$ mm - Valvola di sfianto  $\varnothing 1/8''$   
PRESSIONE MASSIMA D'ESERCIZIO 4 BAR

## ESECUZIONI A RICHIESTA

Verniciatura in una tinta della tabella colori  
Brem con fissaggi B35 colorati +15/25%  
Versione elettrica, e. Alis-One pag. 210

## ATTACCHI DI SERIE

EG  $\varnothing 1/2''$   
A richiesta attacchi  $\varnothing 3/8''$   
Attacchi speciali, pag.279



INTERASSE ATTACCHI ALIS-ONE

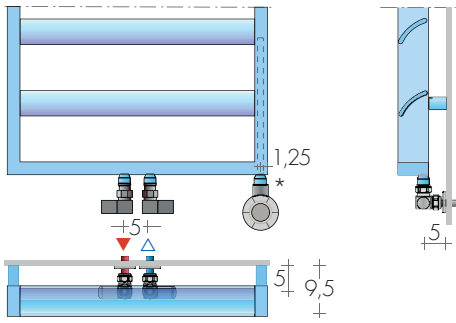

\*manicotto R.E. versioni Miste

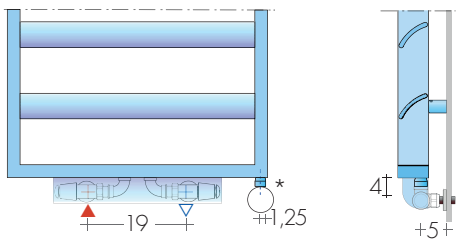

A richiesta: CARTER COPRIVALVOLE (32x6x5 cm) con valvole reverse ▲▽ 19 cm Art. CR 90,50€

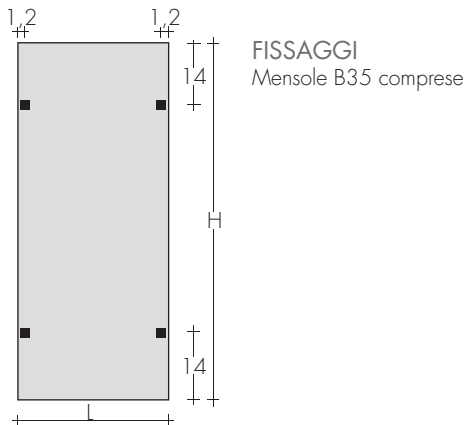
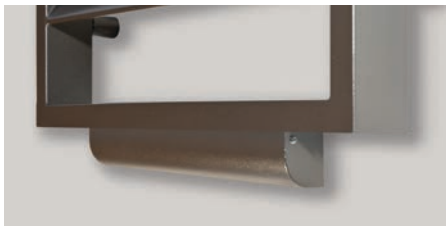

ALIS-ONE 126-51

VALVOLE CONSIGLIATE

KIT VALVOLE CROMATE comprende:

- n°2 Valvole con codoli
- n°2 Raccordi (per multistrato ø16 e rame ø12 e 14)
- n°2 Rosette tonde cromo ø 48, foro ø16

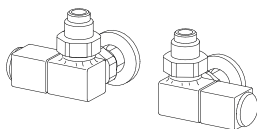

KIT VALVOLE QUADRA comando LATERALE pag. 271 Art. KQL 177,10€ Colore tabella BREM supplemento 49,50€

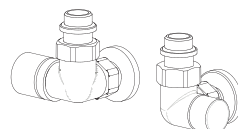

KIT VALVOLE CYL comando LATERALE pag. 273 Art. KCLD 150,50€ Colore tabella BREM supplemento 49,50€

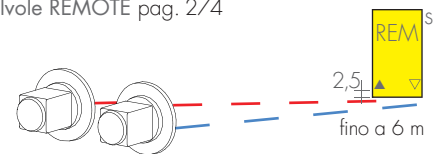

FINITURE SPECIALI pag. 267 Finiture Oro, Bronzo, Nickel spazzolato per 2 valvole KIT Raccordi NICKEL spazz. suppl.Art. RN 28,20€

ATTACCHI REMOTI Art. REM 37,60€ Interasse attacchi sul retro: ▲▽ L - 6cm Valvole REMOTE pag. 274

KIT VALVOLE TON comando LATERALE con testa TERMOSTATICA pag. 269 Art. KTLD 188,60€

design Luigi Brembilla

ASYM, uno scaldasalviette dalla geometria elementare. Una serie di cornici rettangolari,

vuote (ASYMM) o a piastra (ASYMP), che accolgono le salviette sia dalla parte supe-

riore che lateralmente. ASYM può essere installato con i collettori a sinistra o a destra.

## DIMENSIONI

Larghezze: 48 / 56 / 64 cm  
 Altezze: 105 / 145 / 180 cm  
 Profondità: 4,8 cm  
 Sporgenza dal muro: 7,6 cm

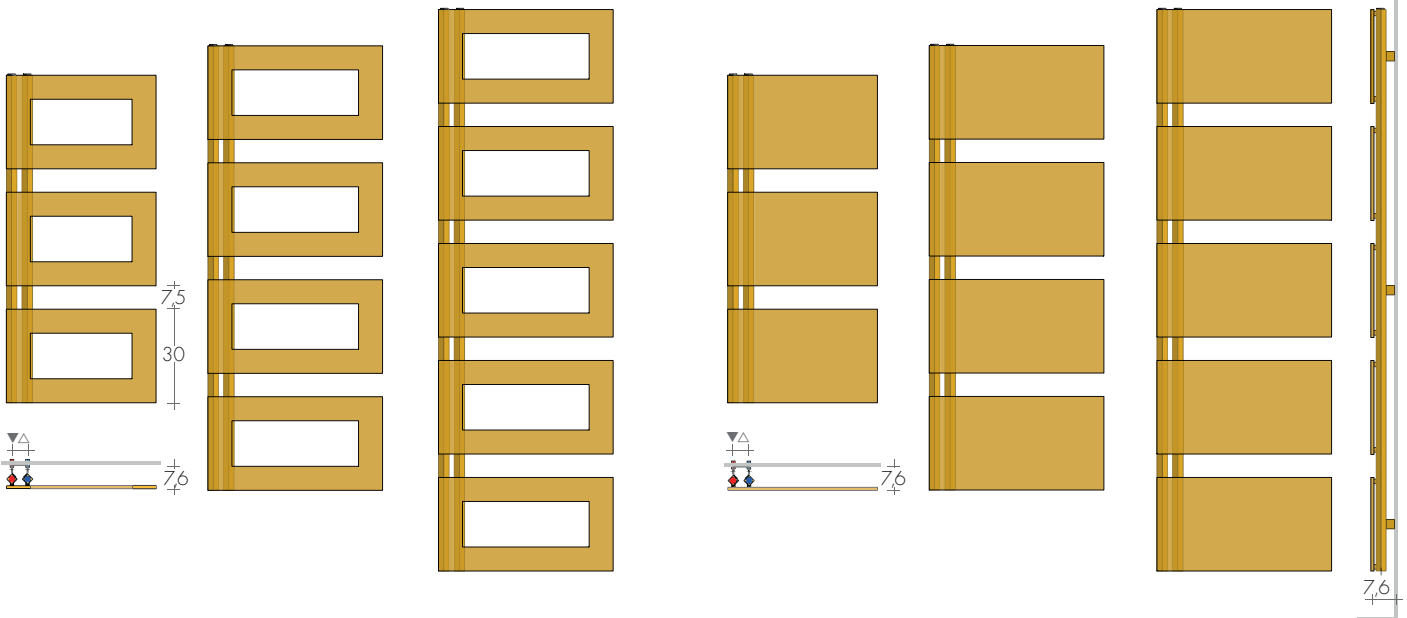

ASYMM 105... ASYMM 145... ASYMM 180... ASYMP 105... ASYMP 145... ASYMP 180...

MODELLO	H/L cm	Bianco di serie sablé SB 9016 €	EN 442			▲ ▼ int.att. cm	Altezza H cm	Larghezza L cm	Peso M Kg	Volume V dm³	VERSIONI MISTE con Resistenza e *	
			Δt 50K watt	Δt 40K watt	Δt 30K watt						Watt	€
ASYMM	105-48	620,80	506	382	266	5	105	48	9,2	3,5	500	97,80
ASYMM	105-56	657,40	556	420	292	5	105	56	10,1	3,8	500	97,80
ASYMM	145-48	751,40	677	511	356	5	142	48	12,3	4,8	650	99,80
ASYMM	145-56	788,00	744	562	391	5	142	56	13,5	5,1	800	104,20
ASYMM	145-64	824,60	811	612	427	5	142	64	14,6	5,5	800	104,20
ASYMM	180-48	860,10	849	641	447	5	180	48	15,5	6,0	900	107,50
ASYMM	180-56	902,10	933	704	491	5	180	56	16,9	6,4	900	107,50
ASYMM	180-64	944,00	1016	767	534	5	180	64	18,3	6,9	900	107,50
ASYMP	105-48	742,00	606	458	319	5	105	48	15,1	4,1	650	99,80
ASYMP	105-56	778,60	682	515	359	5	105	56	17,1	4,5	650	99,80
ASYMP	145-48	908,90	811	612	427	5	142	48	20,2	5,5	800	104,20
ASYMP	145-56	945,50	911	688	479	5	142	56	22,8	6,0	900	107,50
ASYMP	180-48	1017,60	1016	767	534	5	180	48	25,3	6,9	900	107,50
ASYMP	180-56	1054,20	1142	862	601	5	180	56	28,6	7,5	1200	115,20

▶ Pronta consegna

\* Aggiungere: Valvola mista o TR p.207  
 Termostati p.208-209

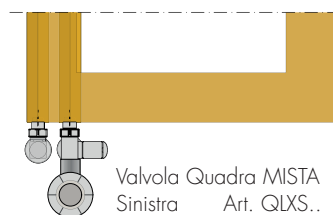

Valvola Quadra MISTA  
 Sinistra Art. QLXS..

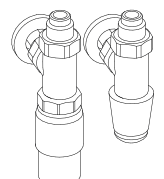

Es. Valvola  
 termostatica  
 non sporgente

## ESECUZIONI DI SERIE

Colore bianco sablé SB9016 mensole B27  
 Tolleranze ± 3mm - Valvole di sfiato ø 1/2"  
 PRESSIONE MASSIMA D'ESERCIZIO 4 BAR

## ESECUZIONI A RICHIESTA

Verniciatura in una tinta della tabella colori  
 Brem con fissaggi colorati +15/25%  
 Versione elettrica, e.Asymm/Asymp p. 211

## ATTACCHI DI SERIE

E ø 1/2",  
 a richiesta G  
 Attacchi a richiesta, pag. 279

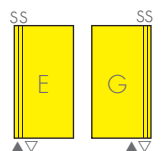

**INTERASSE ATTACCHI**

ASYM con collettori a sinistra, attacchi E

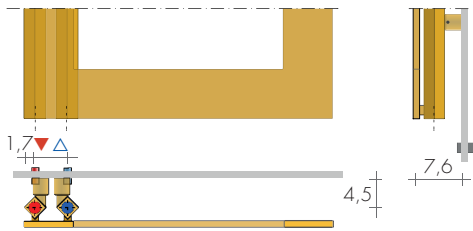

A richiesta collettori a destra, attacchi G

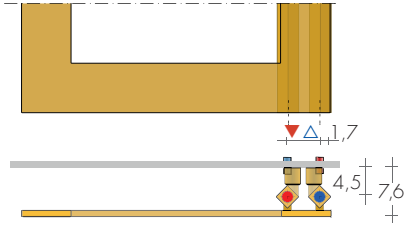

**FISSAGGI**

Mensole comprese

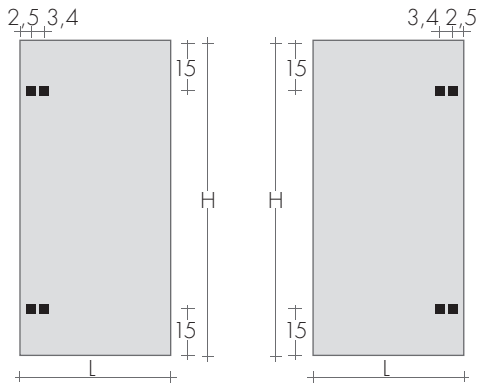

**VALVOLE CONSIGLIATE**

KIT VALVOLE CROMATE COMPRENDE:

- n°2 Valvole con codoli cromo
- n°2 Raccordi (per multistrato  $\varnothing 16$  e rame  $\varnothing 12, 14$ )
- n°2 Rosette tonde cromo  $\varnothing 48$ , foro  $\varnothing 16$

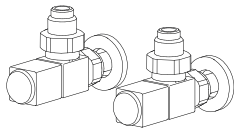

KIT VALVOLE QUADRA a SQUADRA

pag.271 Art. KQS 166,80€

Colore tabella BREM supplemento 49,50€

KIT Raccordi NICKEL spazzolato Art.RN 28,20€

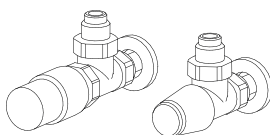

KIT VALVOLE TON a SQUADRA con Testa TERMO-STATICA, pag.269 Art. KTS 176,20€

KIT VALVOLE CYL termostattizzabile a SQUADRA pag.273 Art. KCS 138,80€

Colore tabella BREM supplemento 49,50€

KIT Raccordi NICKEL spazzolato Art.RN 28,20€



ASYMM 145-56



ASYMP 105-48

# CROSS A QUADRI INCROCIATI

PREZZI DAL 01.03.2026 +5%

design Luigi Brembilla

Un gioco di quadri e rettangoli che si incrociano formando un corpo scaldante di cor-

nici radianti decisamente molto particolare. Le forme geometriche possono moltiplicarsi

costituendo sempre un insieme di grande armonia.

## DIMENSIONI

Larghezze: 48/56/64/88/96/120/128/152/168 cm  
Altezze: 48/56/64/88/128/152/168/184/196 cm  
Profondità: 11 cm  
Sporgenza dal muro: 13,5 cm

DISEGNI TECNICI pag.59

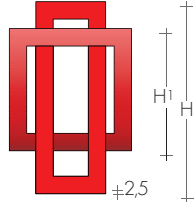
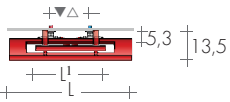

CROSS 88 -...

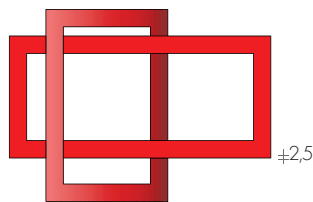

CROSS 88-120

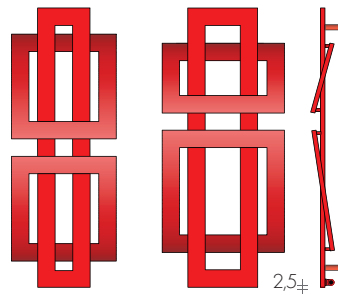

CROSS 128-48 CROSS 128-56

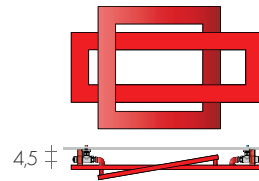

CROSS 48-88  
CROSS 56-88  
CROSS 64-96

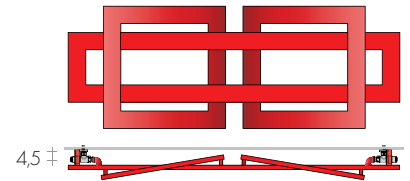

CROSS 48-128 / 56-152 / 64-168

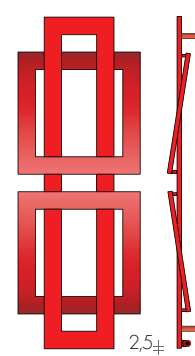

CROSS 152/168-..

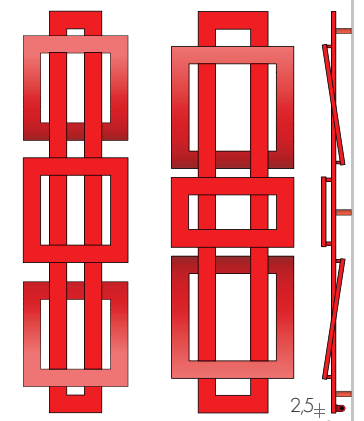

CROSS 184-48 CROSS 184-..

## MODELLO

MODELLO	HL cm	Bianco di serie sablé SB 9016 €	EN 442			▲ ▼ int.att. cm	Altezza H (H1) cm	Larghezza L (Li) cm	Peso M Kg	Volume V dm³	VERSIONI MISTE con Resistenza e manico Watt €	
			Δt 50K watt	Δt 40K watt	Δt 30K watt							
CROSS	48-88	685,90	394	297	208	74	48 (24)	88	7,9	4,8	400	117,20
CROSS	48-128	952,20	635	479	335	114	48 (24)	128	12,8	7,7	650	121,30
CROSS	56-88	714,10	429	324	227	74	56 (32)	88	8,6	5,2	400	117,20
CROSS	56-152	1032,20	772	583	408	138	56 (32)	152	15,6	9,4	800	125,70
CROSS	64-96	774,60	480	362	253	82	64 (32)	96	9,7	5,9	500	119,30
CROSS	64-168	1079,70	892	673	471	154	64 (32)	168	17,6	10,7	900	129,00
CROSS	88-48	673,20	394	297	208	19	88	48 (24)	7,9	4,8	400	117,20
CROSS	88-56	700,70	429	324	227	19	88	56 (32)	8,6	5,2	400	117,20
CROSS	88-120	838,80	617	466	327	106	88	120 (56)	12,4	7,5	650	121,30
CROSS	128-48	944,90	623	470	329	19	128	48 (24)	12,8	7,7	650	121,30
CROSS	128-56	986,30	656	495	346	19	128	56 (32)	13,5	8,2	650	121,30
CROSS	152-48	993,50	673	508	355	19	152	48 (24)	13,8	8,4	650	121,30
CROSS	152-56	1023,30	757	572	400	19	152	56 (32)	15,6	9,4	800	125,70
CROSS	168-64	1093,70	875	661	462	19	168	64 (32)	18,7	11,3	900	129,00
CROSS	184-48	1228,30	890	672	470	19	184	48 (24)	18,7	11,3	900	129,00
CROSS	184-56	1281,00	956	722	505	19	184	56 (32)	20,0	12,1	900	129,00
CROSS	184-64	1335,30	1038	784	548	19	184	64 (32)	21,8	13,2	1200	136,70
C-DIVIS*	196-48	1446,70	890	672	470	5	196	48+4	18,7	11,3	900	129,00

► "PRO" Pronta consegna

Termostati p.208-209

\*Cross-Divisorio con fissaggi laterali e piedino (regolabile h=12/18cm) saldati, mensole B35 pag. 58

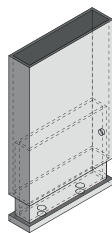

## ESECUZIONI DI SERIE

Colore bianco sablé SB9016 mensole B70  
Tolleranze ± 3mm - Valvola di sfianto ø 1/8"  
PRESSIONE MASSIMA D'ESERCIZIO 4 BAR

## ESECUZIONI A RICHIESTA

Verniciatura in una tinta della tabella colori  
Brem con fissaggi B70 colorati +15/25%  
Versione elettrica e.Cross, pag.218

## ATTACCHI DI SERIE

REG ø 1/2"  
A richiesta attacchi ø 3/8"  
Attacchi speciali pag.279

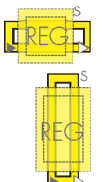

INTERASSE ATTACCHI

Modelli Orizzontali

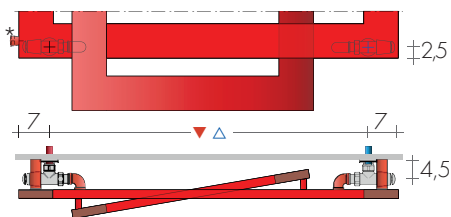

\*manicotto R.E.  
versioni Miste

Modelli Verticali

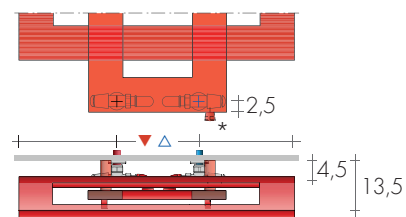

FISSAGGI  
Mensole comprese  
posizione pag. 59



CROSS 184-56

CrossFRAME

VALVOLE CONSIGLIATE

KIT VALVOLE CROMATE comprende:

- n°2 Valvole con codoli
- n°2 Raccordi (per multistrato ø16 e rame ø12 e 14)
- n°2 Rosette tonde cromo ø 48, foro ø16

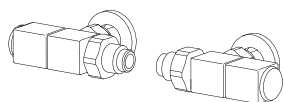

KIT VALVOLE QUADRA REVERSE  
pag.271 Art. KQR 166,80€  
Colore tabella BREM supplemento 49,50€

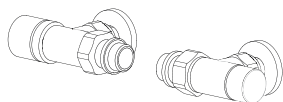

KIT VALVOLE CYL termostattizzabile REVERSA  
pag. 273 Art. KCR 138,80€  
Colore tabella BREM supplemento 49,50€

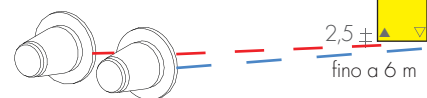

ATTACCHI REMOTI Art. REM 37,60€  
Interasse attacchi sul retro: ▲▼ L<sup>1</sup> - 6 cm  
KIT Raccordi NICKEL spazz. suppl.Art. RN 28,20€  
Valvole REMOTE pag. 274

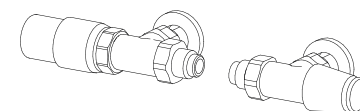

KIT VALVOLE TON REVERSE con TESTA TERMO-  
STATICA, pag. 269 Art. KTR 176,20€



CROSS 48-128



CROSS 152-56



CROSS 184-56



C-DIVIS 196 - 48

CROSS DIVIS  
CROSS DIVISORIO

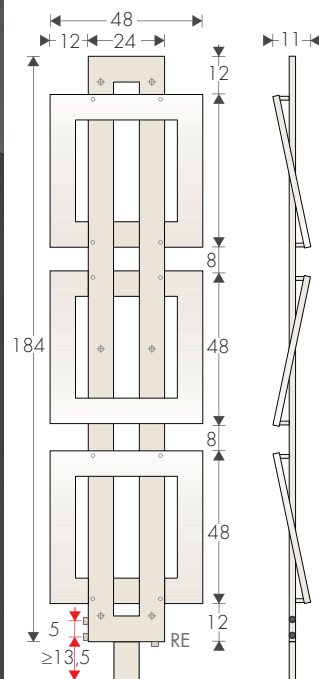

ATTACCHI DI SERIE

AC  $\varnothing$  1/2"  
a richiesta BD

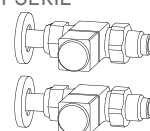

VALVOLE CONSIGLiate  
KIT Valvole QUADRA DIRITTE  
p. 271 Art. KQD 176,00€

# DISEGNI TECNICI CROSS (a quadri incrociati)

## INTERASSE ATTACCHI E FISSAGGI

PREZZI DAL 01.03.2026 +5%

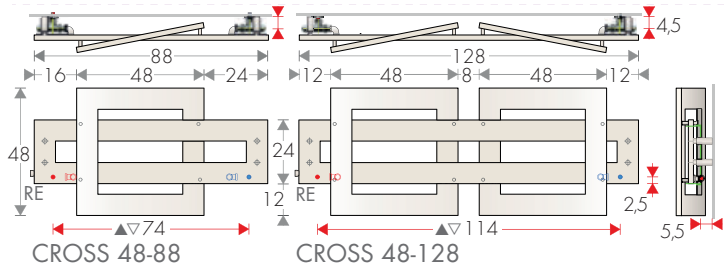

► M mandata  
▷ R ritorno  
RE: Manicotto per Resistenza Elettrica (a richiesta)

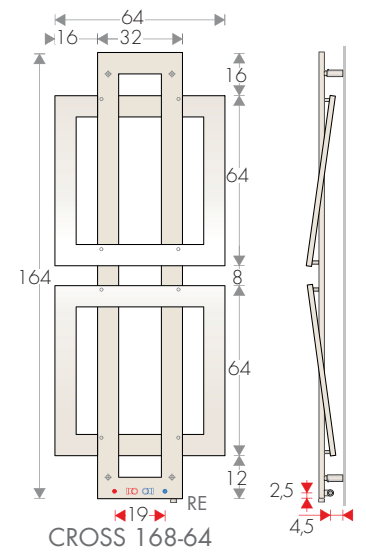
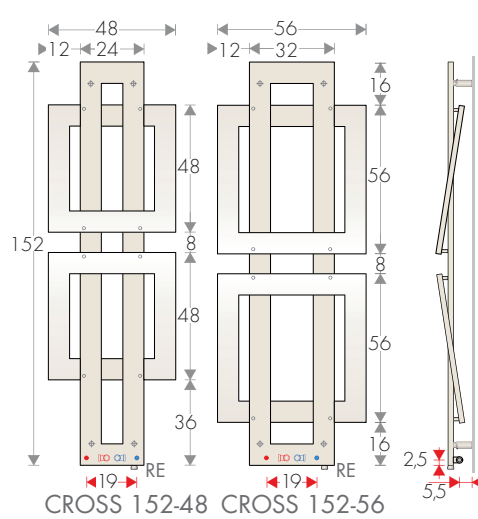
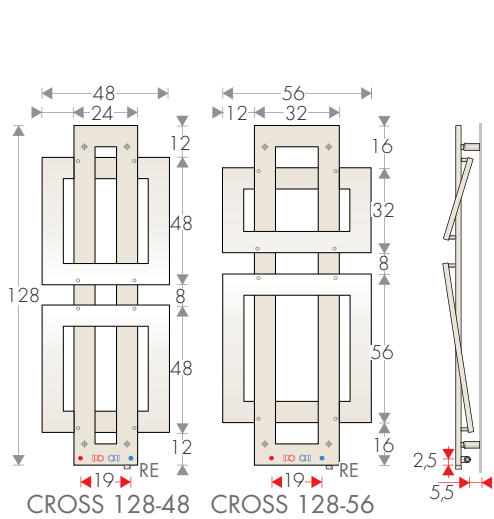
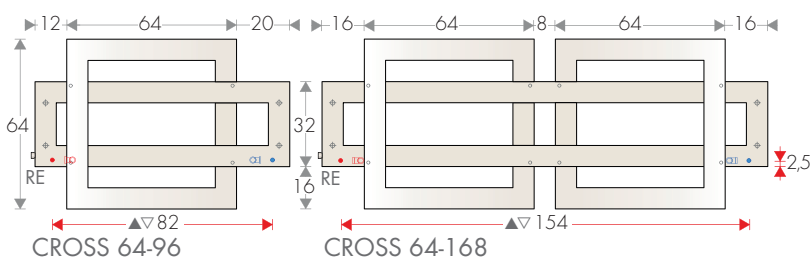
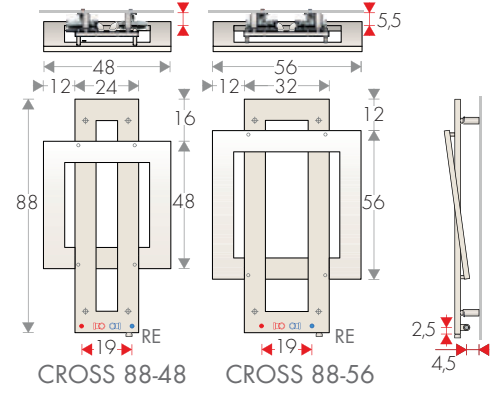
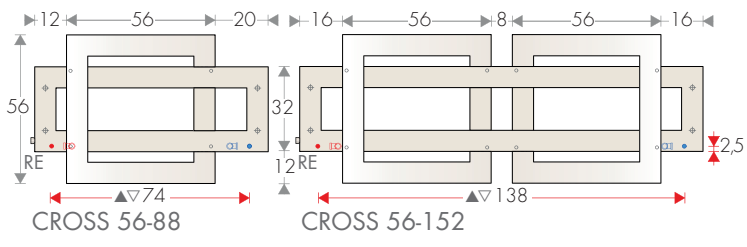
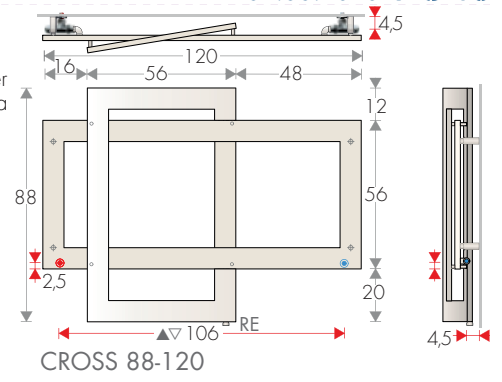

### POSIZIONE MENSOLE

Modelli ORIZZONTALI

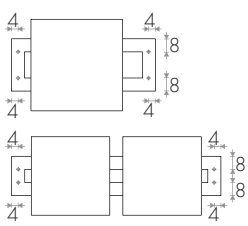

Modelli VERTICALI

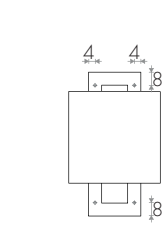

### INTERASSE ATTACCHI con VALVOLE REVERSE

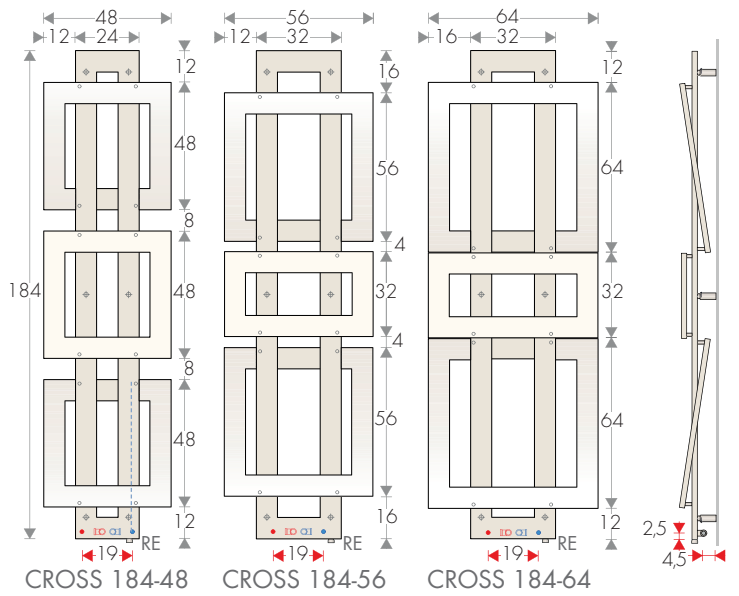
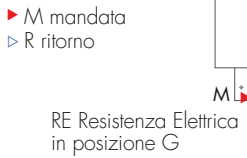
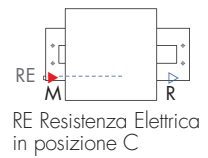

CrossFRAME

# CROSS-Q

## SCALDASALVIETTE A QUADRI SOVRAPPosti

PREZZI DAL 01.03.2026 +5%

design Luia Brembilla

Un gioco di quadri e rettangoli che si sovrappongono formando un corpo scaldante di

cornici radianti molto particolare. Le forme geometriche nello scaldasalviette CROSS-Q a

quadri sovrapposti possono moltiplicarsi costituendo sempre un insieme di grande armonia.

### DIMENSIONI

Larghezze 48/56/64/88/96/120/128/152/168 cm

Altezze 48/56/64/88/128/152/168/184 cm

Profondità 6 cm

Sporgenza dal muro 9,5 / 13cm

DISEGNI TECNICI pag.64

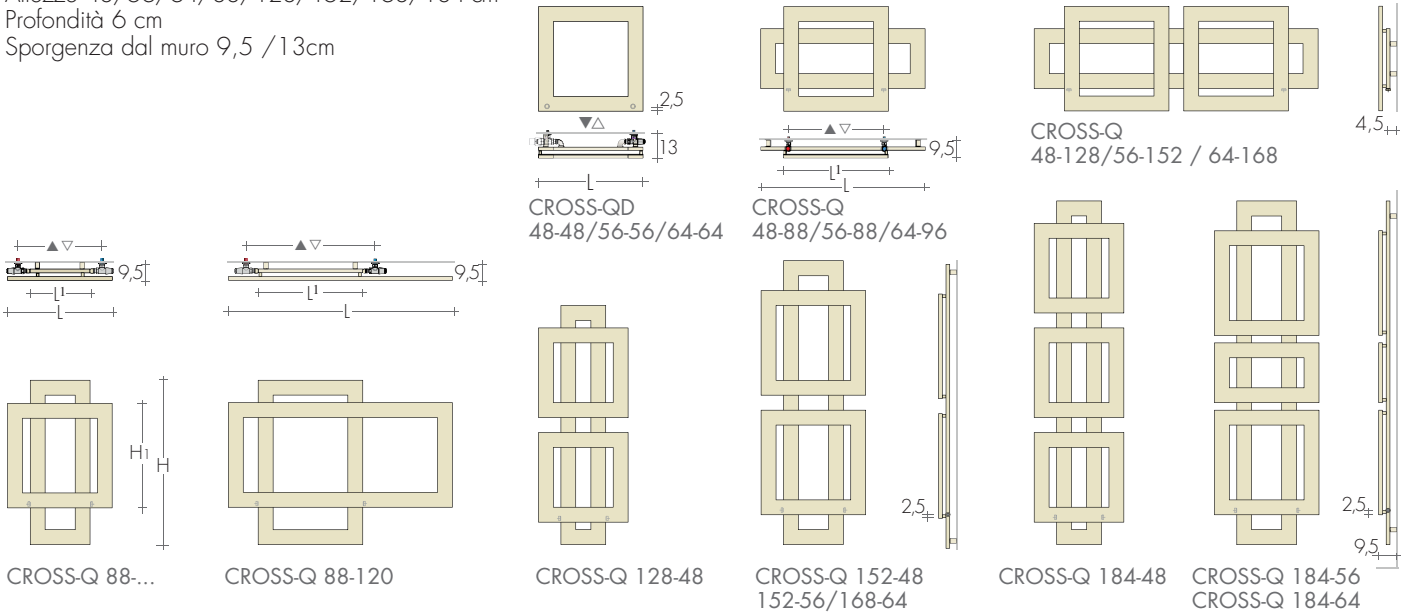

### MODELLO'25

	H1 cm	Bianco di serie sablé SB 9016 €	EN 442 $\Delta t$ 50K watt	$\Delta t$ 40K watt	$\Delta t$ 30K watt	$\blacktriangle \nabla$ int.att. cm	Altezza H (H1) cm	Larghezza L (L1) cm	Peso M Kg	Volume V dm <sup>3</sup>	VERSIONI MISTE con Resistenza e manicotto Watt	€
CROSS-QD	48-48	415,50	244	184	128	38	48	48	6,5	5,2	250	115,10
CROSS-QD	56-56	452,40	292	220	154	46	56	56	7,7	6,2	300	116,10
CROSS-QD	64-64	474,80	339	256	178	54	64	64	9,0	7,1	400	117,20
CROSS-Q	48-88	653,30	394	297	208	43	48 (24)	88 (48)	7,9	4,8	400	117,20
CROSS-Q	48-128	906,90	635	479	335	99	48 (24)	128 (104)	12,8	7,7	650	121,30
CROSS-Q	56-88	680,20	429	324	227	51	56 (32)	88 (56)	8,6	5,2	400	117,20
CROSS-Q	56-152	983,00	772	583	408	115	56 (32)	152 (120)	15,6	9,4	800	125,70
CROSS-Q	64-96	737,60	480	362	253	59	64 (32)	96 (64)	9,7	5,9	500	119,30
CROSS-Q	64-168	1028,50	892	673	471	131	64 (32)	168 (136)	17,6	10,7	900	129,00
CROSS-Q	88-48	641,20	394	297	208	37	88	48 (24)	7,9	4,8	400	117,20
CROSS-Q	88-56	667,40	429	324	227	45	88	56 (32)	8,6	5,2	400	117,20
CROSS-Q	88-120	798,70	617	466	326	69	88	120 (56)	12,4	7,5	650	121,30
CROSS-Q	128-48	900,00	623	470	329	37	128	48 (24)	12,8	7,7	650	121,30
CROSS-Q	128-56	939,30	656	495	346	45	128	56 (32)	13,5	8,2	650	121,30
CROSS-Q	152-48	946,20	673	508	355	37	152	48 (24)	13,8	8,4	650	121,30
CROSS-Q	152-56	974,60	757	572	400	45	152	56 (32)	15,6	9,4	800	125,70
CROSS-Q	168-64	1041,60	875	661	462	45	168	64 (32)	18,7	11,3	900	129,00
CROSS-Q	184-48	1169,80	890	672	470	37	184	48 (24)	18,7	11,3	900	129,00
CROSS-Q	184-56	1220,10	956	722	505	45	184	56 (32)	20,0	12,1	900	129,00
CROSS-Q	184-64	1271,70	1038	784	548	45	184	64 (32)	21,8	13,2	1200	136,70

► "PRO" Pronta consegna

Termostati p.208-209



VERSIONE MISTA  
con capricavo R.E.

### ESECUZIONI DI SERIE

Colore bianco sablé SB9016 mensola B35  
Tolleranze  $\pm$  3mm - Valvola di sfizio  $\varnothing$  1/8"  
PRESSIONE MASSIMA D'ESERCIZIO 4 BAR

### ESECUZIONI A RICHIESTA

Verniciatura in una tinta della tabella colori  
Brem con fissaggi B35 colorati +15/25%  
Versione elettrica e.CROSS-Q, p.221

### ATTACCHI DI SERIE

REG  $\varnothing$  1/2"  
A richiesta attacchi  $\varnothing$  3/8"  
Attacchi speciali, pag.279

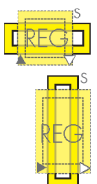

## INTERASSE ATTACCHI

Modelli Orizzontali

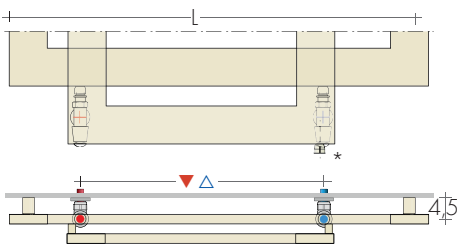

Modelli Verticali

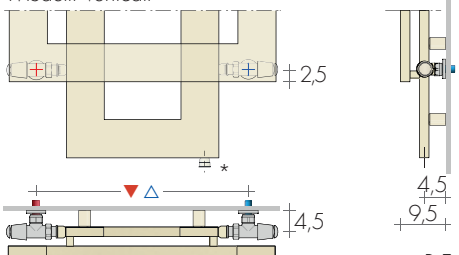

\* manicotto R.E. versioni Miste

CROSS-QD

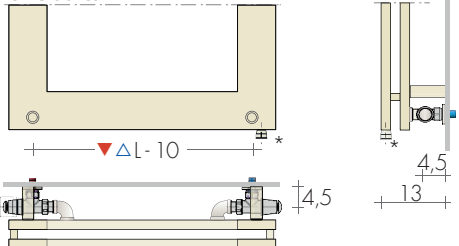

A richiesta, senza supplemento, attacchi EG ▲▽L-10. Valvole a vista comando laterale e profondità 9,5 cm



**FISSAGGI B35**  
Mensole comprese  
posizione pag. 64



CROSS-Q 184-48

CrossFRAME

## VALVOLE CONSIGLIATE

KIT VALVOLE CROMATE comprende:

- n°2 Valvole con codoli
- n°2 Raccordi (per multistrato ø16 e rame ø12 e 14)
- n°2 Rosette tonde cromo ø 48, foro ø16

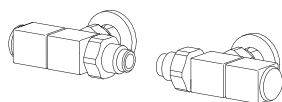

**KIT VALVOLE QUADRA REVERSE**  
pag. 271 Art. KQR 166,80€  
Colore tabella BREM supplemento 49,50€

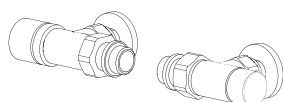

**KIT VALVOLE CYL termostattabile REVERSA**  
pag. 273 Art. KCR 138,80€  
Colore tabella BREM supplemento 49,50€

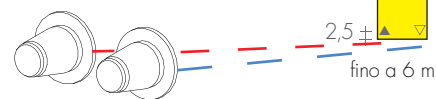

**KIT VALVOLE TON REVERSE con TESTA TERMOSTATICA**, pag. 269 Art. KTR 176,20€

FINITURE SPECIALI: Oro, Bronzo, Nickel spazzolato, Foglia O/A per 2 valvole pag. 267  
KIT Raccordi NICKEL spazz. suppl. Art. RN 28,20€

**ATTACCHI REMOTI** Art. REM 37,60€  
modelli verticali, interasse ▲▽L<sup>1</sup>-6 cm  
modelli orizzontali, interasse ▲▽L-6 cm  
Valvole REMOTE pag. 274

REM<sup>S</sup>

2,5 ±  
fino a 6 m

# CROSS FOGLIA DORATA/ARGENTO

A QUADRI SOVRAPPOSTI

PREZZI DAL 01.03.2026 **+5%**

design Luigi Brembilla

CROSS può essere fornito nella versione a foglia dorata o foglia d'argento creando composizioni e magici effetti, di non più di quattro elementi sovrapposti. Può essere uno scaldasalviette ma può anche essere un calorifero d'arredo per qualsiasi ambiente.



CROSS FO 128-48

CROSS-FO Foglia Dorata  
CROSS-FA Foglia Argento  
Dati tecnici e disegni  
pag. 60 e 64

MODELLO	Foglia Dorata		EN 442 Δt 50 K watt	R.E. W
	Hl cm	Foglia Argento €		
CROSS-F.. 48-88	48-88	1920,70	394	400
CROSS-F.. 48-128	48-128	2666,10	635	650
CROSS-F.. 56-88	56-88	1999,50	429	400
CROSS-F.. 56-152	56-152	2890,10	772	800
CROSS-F.. 64-96	64-96	2168,80	480	500
CROSS-F.. 64-168	64-168	3023,10	892	900
CROSS-F.. 88-48	88-48	1884,80	394	400
CROSS-F.. 88-56	88-56	1962,20	429	400
CROSS-F.. 88-120	88-120	2039,90	617	650
CROSS-F.. 128-48	128-48	2348,40	623	650
CROSS-F.. 128-56	128-56	2645,40	656	650
CROSS-F.. 152-56	152-56	2761,70	757	800
CROSS-F.. 168-64	168-64	2865,50	875	900
CROSS-F.. 184-48	184-48	2989,90	890	900
CROSS-F.. 184-56	184-56	3118,30	956	900

Foglia Argento



# CROSS BICOLOR / TRICOLOR

A QUADRI SOVRAPPOSTI

CROSS può essere fornito nella versione a diversi colori creando affascinanti composizioni di non più di 4 elementi sovrapposti. Può essere utilizzato come scaldasalviette ma può anche essere un calorifero d'arredo per qualsiasi ambiente.



CROSS TRIC 152-56

## INDICAZIONE COLORI

- a scelta tabella Brem
- 1 - Rettangolo sul retro (colore ...)
  - 2 - Quadro superiore o sinistro
  - 3 - Quadro inferiore o destro
  - 4 - Quadro centrale

MODELLO	Hl cm	Colori BREM		EN 442 Δt 50 K watt
		a scelta €		
CROSS BIC	48-88	994,70		394
CROSS BIC	48-128	1380,50		635
CROSS BIC	56-88	1035,40		429
CROSS BIC	56-152	1496,80		772
CROSS BIC	64-96	1123,30		480
CROSS BIC	64-168	1565,60		892
CROSS BIC	88-48	976,00		394
CROSS BIC	88-56	1016,20		429
CROSS BIC	88-120	1216,10		617
CROSS BIC	128-48	1369,90		623
CROSS BIC	128-56	1430,30		656
CROSS BIC	152-56	1483,80		757
CROSS BIC	168-64	1673,50		875
CROSS BIC	184-48	1820,00		890
CROSS BIC	184-56	1887,80		956
CROSS TRIC	48-128	1475,80		635
CROSS TRIC	56-152	1600,00		772
CROSS TRIC	64-168	1686,70		892
CROSS TRIC	128-48	1464,40		623
CROSS TRIC	128-56	1528,80		656
CROSS TRIC	152-56	1586,10		757
CROSS TRIC	168-64	1790,60		875
CROSS TRIC	184-48	1947,30		890
CROSS TRIC	184-56	2020,00		956

Dati tecnici e disegni  
pag. 60 e 64

# CROSS CROM

## A QUADRI SOVRAPPosti

PREZZI DAL 01.03.2026 +5%

design Luigi Brembilla

CROSS CROM è realizzato nella versione cromata creando affascinanti composizioni di non più di quattro elementi sovrapposti. Può essere uno scaldasalviette ma può essere anche un calorifero d'arredo per qualsiasi ambiente.



CROSS CROM 88-120

MODELLO	H-L cm	Finitura cromata €	EN 442			▲▽ int.att. cm	Altezza H (H1) cm	larghezza L (L1) cm	Peso M Kg	Volume V dm <sup>3</sup>	VERSIONI MISTE con Resistenza e manico	
			Δt 50 K watt	Δt 40 K watt	Δt 30 K watt						Watt	€
CROSS CROM	48-88	1598,20	339	256	179	43	48 (24)	88 (48)	7,9	4,8	300	116,10
CROSS CROM	48-128	2218,70	533	402	281	99	48 (24)	128 (104)	12,8	7,7	500	119,30
CROSS CROM	56-88	1663,90	369	279	195	51	56 (32)	88 (56)	8,6	5,2	400	117,20
CROSS CROM	56-152	2405,10	648	489	342	115	56 (32)	152 (120)	15,6	9,4	650	121,30
CROSS CROM	64-96	1805,10	413	312	218	59	64 (32)	96 (64)	9,7	5,9	400	117,20
CROSS CROM	64-168	2515,50	758	572	400	131	64 (32)	168 (136)	17,6	10,7	800	125,70
CROSS CROM	88-48	1568,60	339	256	179	37	88	48 (24)	7,9	4,8	400	117,20
CROSS CROM	88-56	1632,60	369	279	195	45	88	56 (32)	8,6	5,2	400	117,20
CROSS CROM	88-120	1953,90	531	401	280	69	88	120 (56)	12,4	7,5	500	119,30
CROSS CROM	128-48	2201,10	511	386	270	37	128	48 (24)	12,8	7,7	500	119,30
CROSS CROM	128-56	2298,10	538	406	284	45	128	56 (32)	13,5	8,2	500	119,30
CROSS CROM	152-56	2384,30	621	469	328	45	152	56 (32)	15,6	9,4	650	121,30
CROSS CROM	168-64	2488,20	733	553	387	45	168	64 (32)	18,7	11,3	650	121,30
CROSS CROM	184-48	3164,20	712	538	376	37	184	48 (24)	18,7	11,3	650	121,30
CROSS CROM	184-56	3299,80	880	664	465	45	184	56 (32)	20,0	12,1	800	125,70

Disegni pag. 64

Termostati p.208-209

### ESECUZIONI DI SERIE

Finitura e mensola B35 cromate

Tolleranze ± 3mm - Valvola di sfianto ø 1/8"

PRESSIONE MASSIMA D'ESERCIZIO 4 BAR

### ESECUZIONI A RICHIESTA

Dimensioni non comprese nella tabella

Mensola B70 per una sporgenza di 13 cm

Versione elettrica e Cross Crom, pag. 219

### ATTACCHI DI SERIE

REG ø 1/2"

A richiesta attacchi ø 3/8"

Attacchi speciali, pag.279

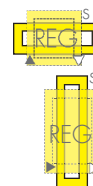

# DISEGNI TECNICI CROSS-Q

PREZZI DAL 01.03.2026 +5%

(a quadri sovrapposti) INTERASSE ATTACCHI E FISSAGGI

CrossFRAME

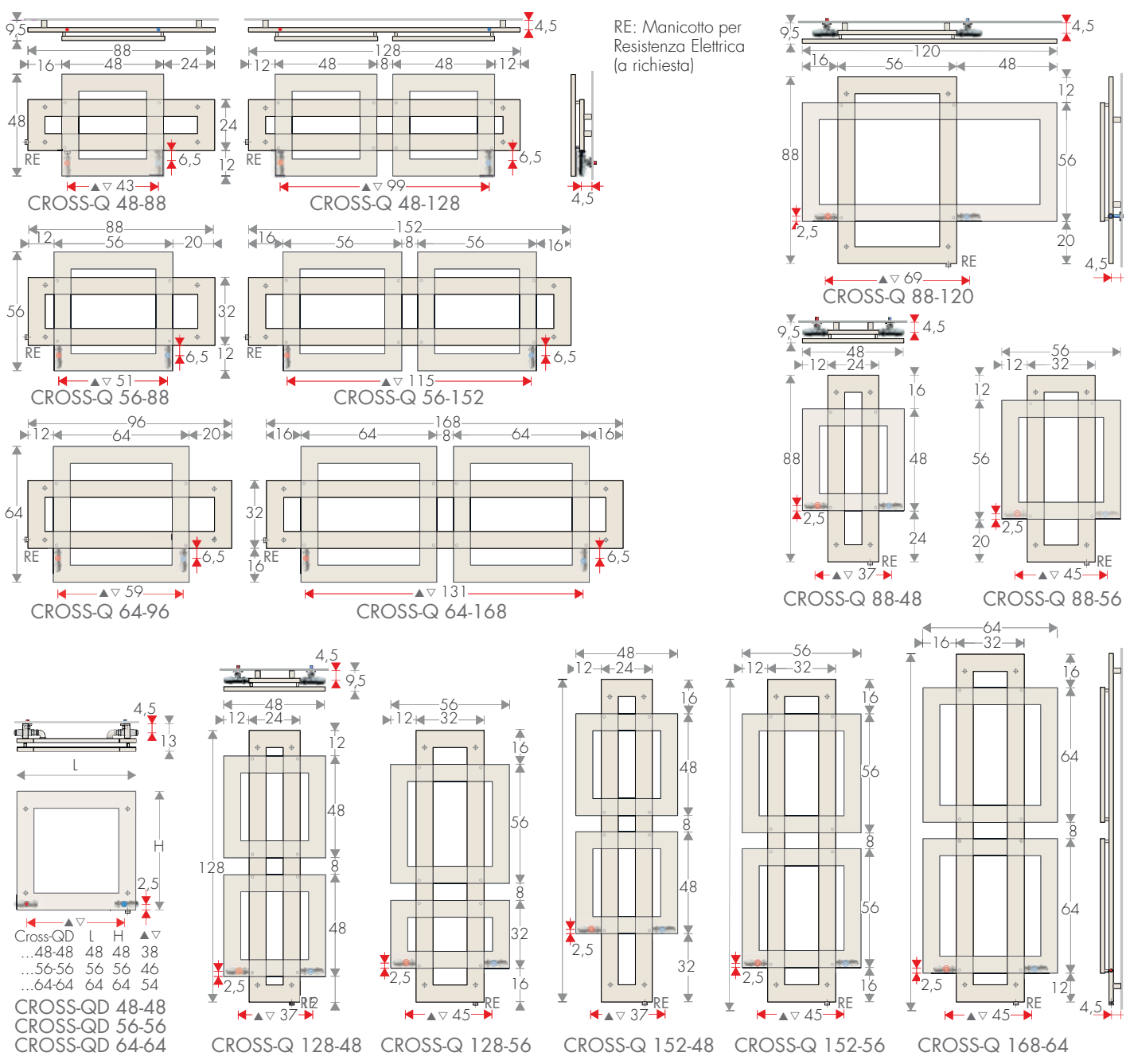

## POSIZIONE MENSOLE

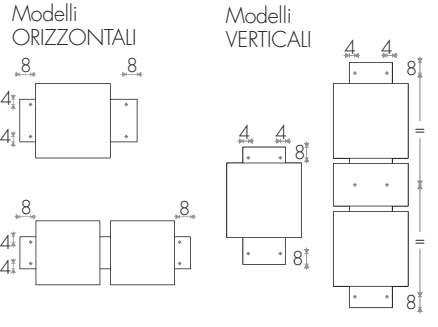

## INTERASSE ATTACCHI con VALVOLE REVERSE

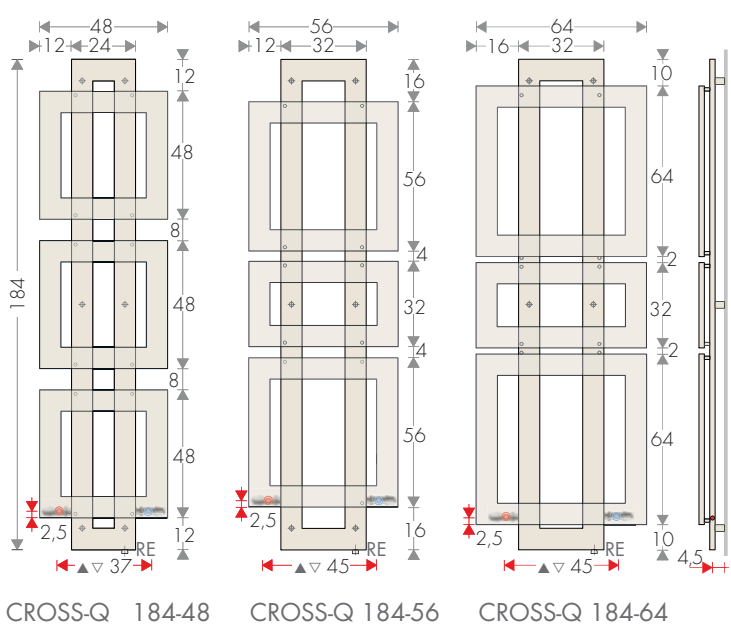

# DISEGNI TECNICI CROSS-R/RV

PREZZI DAL 01.03.2026 +5%

## INTERASSE ATTACCHI E FISSAGGI

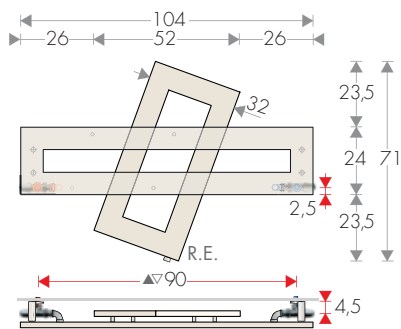

CROSS-R 70-104

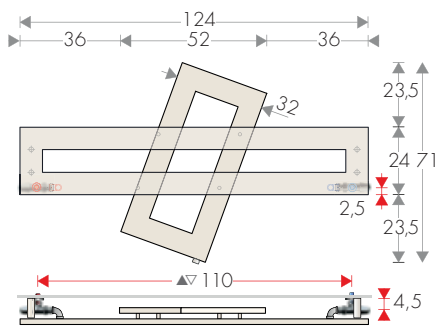

CROSS-R 70-124

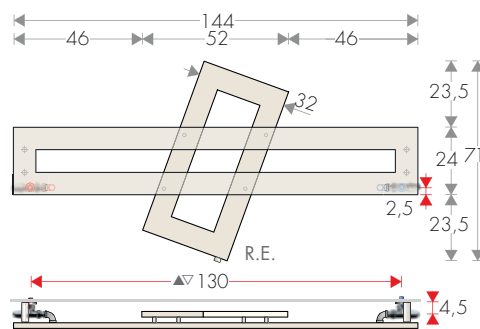

CROSS-R 70-144

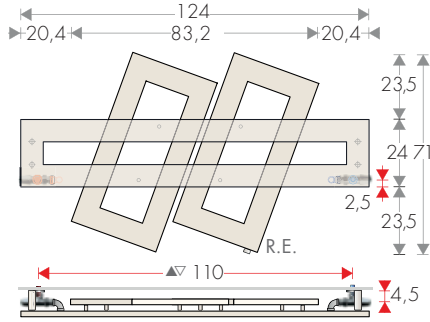

CROSS-R2 70-124

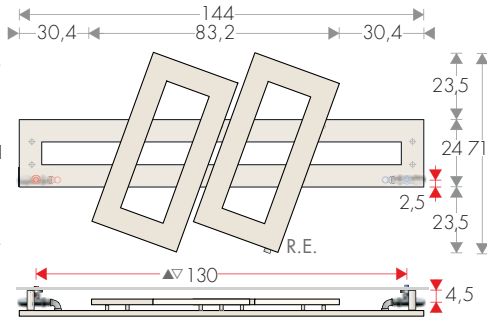

CROSS-R2 70-144

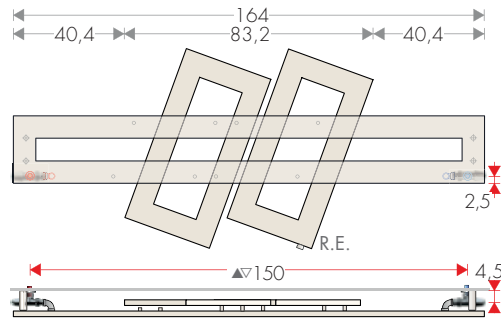

CROSS-R2 70-164

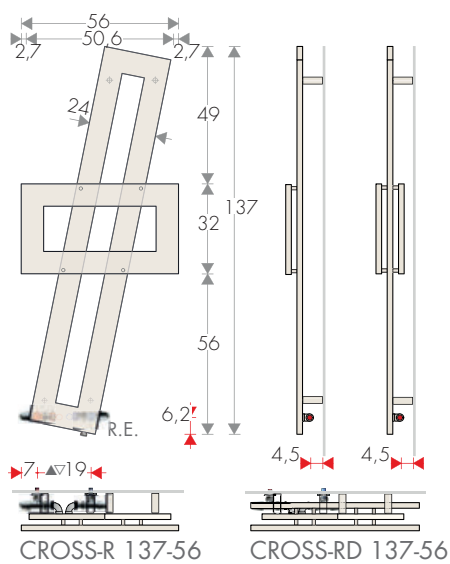

CROSS-R 137-56

CROSS-RD 137-56

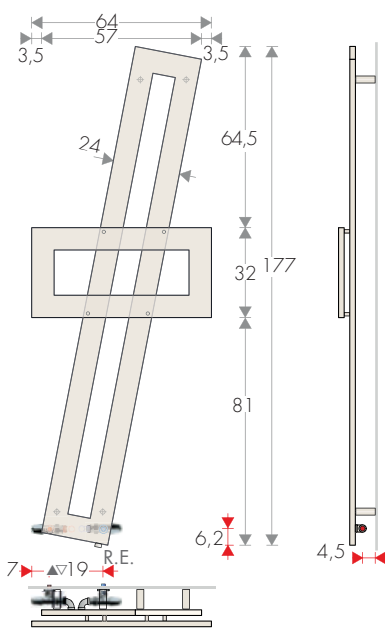

CROSS-R 177-64

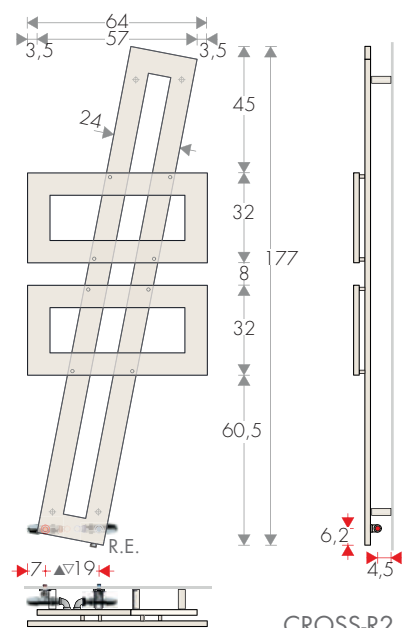

CROSS-R2 177-64

CROSS-R2 177-64

RE: Manicotto per Resistenza Elettrica (a richiesta)

POSIZIONE MENSOLE

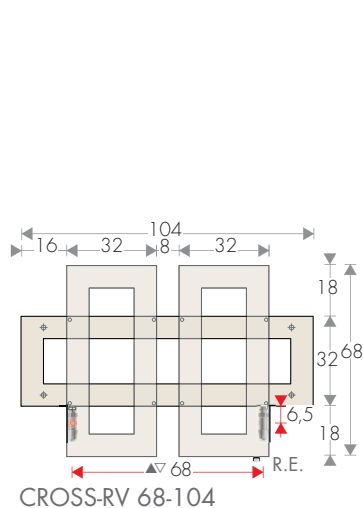
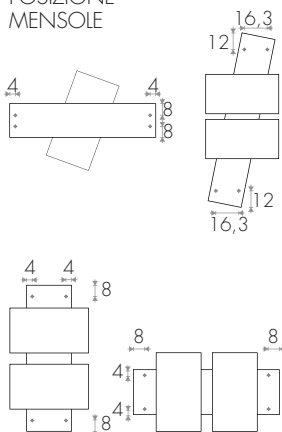

CROSS-RV 68-104

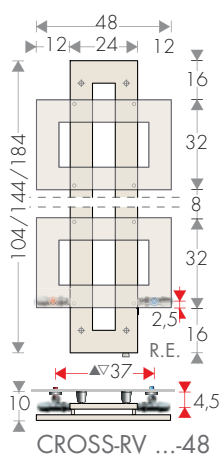

CROSS-RV ...-48

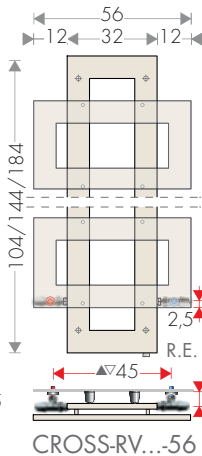

CROSS-RV ...-56

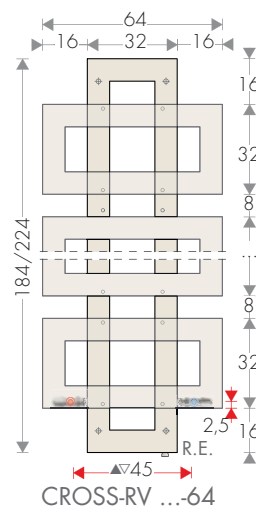

CROSS-RV ...-64

# CROSS-R

## A RETTANGOLI SOVRAPPOSTI

PREZZI DAL 01.03.2026 **+5%**

design Luigi Brebbia

Un gioco di soli rettangoli che si sovrappongono a formare un corpo scaldante

decisamente molto particolare.  
Può essere uno scaldasalviette ma può

essere anche un calorifero dalla pura forma decorativa per qualsiasi ambiente.

### DIMENSIONI

Larghezze 56/64/104/124/144/164 cm

Altezze 70/137/177 cm

Profondità 6/10 cm

Sporgenza dal muro 9/13 cm

DATI TECNICI pag.65

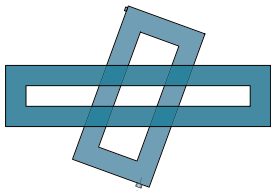
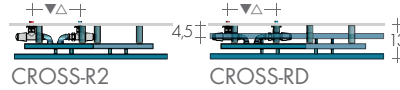

CROSS-R 70-104/124/144

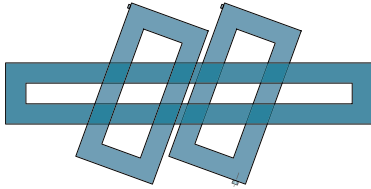

CROSS-R2 70-124/144 /164

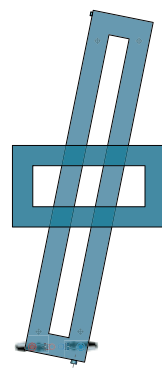

CROSS-R 137-56  
CROSS-R 177-64

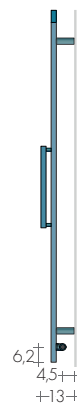

CROSS-RD  
137-56

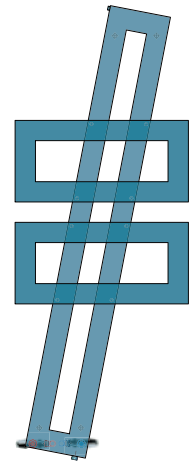

CROSS-R2 177-64

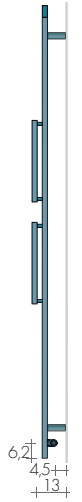

MODELLO	HL cm	Bianco di serie sablé SB 9016 €	EN 442			▲ ▼ int.att. cm	Altezza H cm	Larghezza L cm	Peso M Kg	Volume V dm³	VERSIONI MISTE con Resistenza e manico Watt €	
			Δt 50K watt	Δt 40K watt	Δt 30K watt						Watt	€
CROSS-R	70-104	740,90	433	327	229	90	71	104	8,3	5	400	117,20
CROSS-R	70-124	810,80	478	361	253	110	71	124	9,2	5,6	500	119,30
CROSS-R	70-144	880,70	523	395	275	130	71	144	10	6,1	500	119,30
CROSS-R2	70-124	1047,52	655	494	346	110	71	124	12,6	7,6	650	121,30
CROSS-R2	70-144	1124,80	703	531	370	130	71	144	13,5	8,2	650	121,30
CROSS-R2	70-164	1289,00	758	572	400	150	71	164	14,5	8,8	800	125,70
CROSS-R	137-56	820,80	479	365	256	19	137,4	56	9,5	5,8	500	119,30
CROSS-RD	137-56	1110,70	625	479	335	19	137,4	56	12,8	7,7	650	121,30
CROSS-R	177-64	1060,00	585	445	312	19	177,4	64	11,6	7,0	650	121,30
CROSS-R2	177-64	1241,90	750	574	401	19	177,4	64	15,2	9,2	800	125,70
VERSIONE CROMATA												
R-CROM	70-124	1921,70	402	303	212	110	71	124	12,6	7,6	400	117,20
R-CROM	137-56	2019,60	383	293	205	19	137,4	56	9,5	5,8	400	117,20

► "PRO" Pronta consegna

Termostati p.208-209

### ESECUZIONI DI SERIE

Colore bianco sablé SB9016 mensola B70  
Tolleranze ± 3mm - Valvola di sfianto ø 1/8"  
PRESSIONE MASSIMA D'ESERCIZIO 4 BAR

### ESECUZIONI A RICHIESTA

Verniciatura in una tinta della tabella colori  
Brem con fissaggi B70 colorati +15/25%  
Versione elettrica e.Cross-R, pag.222

### ATTACCHI DI SERIE

REG ø 1/2"  
A richiesta attacchi ø 3/8"  
Attacchi speciali, pag.279

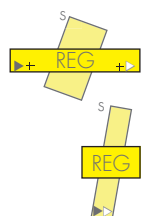

**INTERASSE ATTACCHI**

Modelli Orizzontali

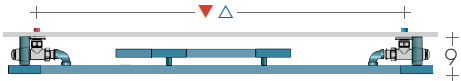
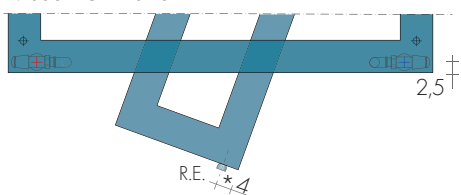

\*manicotto R.E.  
versioni Miste

Modelli Verticali

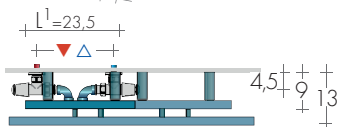
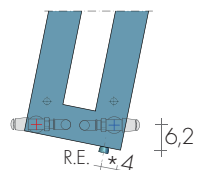

**FISSAGGI**  
Mensole comprese,  
posizione pag. 65



R-CROM 137-56

**VALVOLE CONSIGLIATE**

KIT VALVOLE CROMATE comprende:

- n°2 Valvole con codoli
- n°2 Raccordi (per multistrato ø16 e rame ø12 e 14)
- n°2 Rosette tonde cromo ø 48, foro ø16

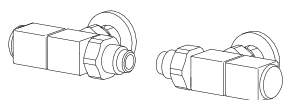

KIT VALVOLE QUADRA REVERSE  
pag. 271 Art. KQR 166,80€  
Colore tabella BREM supplemento 49,50€

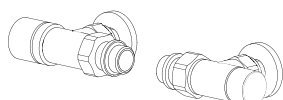

KIT VALVOLE CYL termostattabile REVERSA  
pag. 273 Art. KCR 138,80€  
Colore tabella BREM supplemento 49,50€

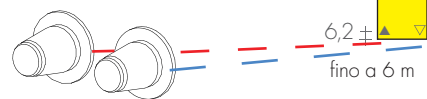

ATTACCHI REMOTI Art. REM 37,60€  
modelli verticali, interasse ▲▽ L<sup>1</sup> - 6 cm  
modelli orizzontali, interasse ▲▽ L - 6 cm  
Valvole REMOTE pag. 274

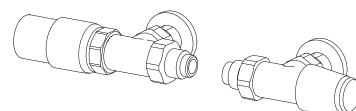

KIT VALVOLE TON REVERSE con TESTA TERMO-  
STATICA, pag. 269 Art. KTR 176,20€

# CROSS-RV A RETTANGOLI SOVRAPPOSTI

PREZZI DAL 01.03.2026 +5%

design Luigi Brebbia

Una composizione regolare di soli rettangoli che si sovrappongono a formare un corpo

scaldante decisamente lineare. Può essere uno scaldasalviette ma può essere

anche un calorifero dalla pura forma decorativa per qualsiasi ambiente.

## DIMENSIONI

larghezze 48/56/64/104 cm

Altezze 68/104/144/184/208/224 cm

Profondità 6 cm

Sporgenza dal muro 9,5 cm

DISEGNI TECNICI pag.65

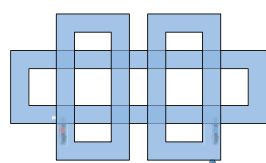

CROSS-RV 68-104

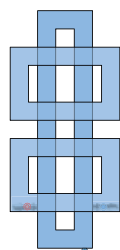
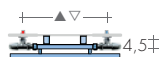

CROSS-RV 104-..

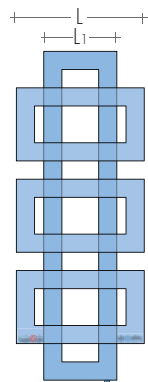

CROSS-RV 144-..

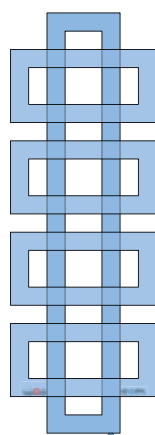

CROSS-RV 184-..

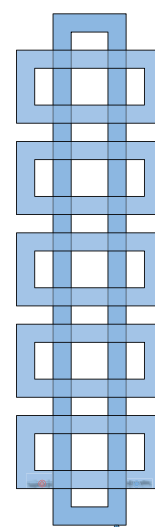

CROSS-RV 224-64  
CROSS-RV\* 208-64

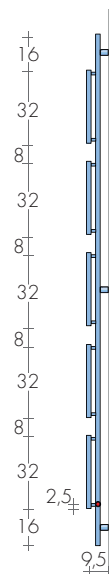

MODELLO	H-L cm	Bianco di serie sablé SB 9016 €	EN 442			▲ ▼ int.att. cm	Altezza H cm	Larghezza L (L1) cm	Peso M Kg	Volume V dm <sup>3</sup>	VERSIONI MISTE con Resistenza e manicotto €	
			Δt 50K watt	Δt 40K watt	Δt 30K watt						W	€
CROSS-RV	68-104	968,90	611	461	321	68	68	104 (72)	12,1	7,3	650	121,30
CROSS-RV	104-48	872,90	509	384	267	37	104	48 (24)	10,4	6,3	500	119,30
CROSS-RV	104-56	901,10	560	422	294	45	104	56 (32)	11,4	6,9	650	121,30
CROSS-RV	144-48	1115,80	729	550	383	37	144	48 (24)	14,5	8,8	800	125,70
CROSS-RV	144-56	1151,20	797	601	419	45	144	56 (32)	15,9	9,6	800	125,70
CROSS-RV	184-48	1360,20	923	696	485	37	184	48 (24)	19,4	11,7	900	129,00
CROSS-RV	184-56	1402,60	1005	758	528	45	184	56 (32)	21,1	12,8	900	129,00
CROSS-RV	184-64	1439,30	1071	808	563	45	184	64 (32)	22,5	13,6	1200	136,70
CROSS-RV	224-64	1518,20	1293	975	679	45	224	64 (32)	28,1	16,9	1200	136,70
CROSS-RV*	208-64	1475,40	1261	951	662	45	208	64 (32)	28,1	16,9	1200	136,70

\*Distanza tra i rettangoli 4 cm.

ALTRE DIMENSIONI a richiesta

Termostati p.208-209

## ESECUZIONI DI SERIE

Colore bianco sablé SB9016 mensole B35  
Tolleranze ± 3mm - Valvola di sfianto ø 1/8"  
PRESSIONE MASSIMA D'ESERCIZIO 4 BAR

## ESECUZIONI A RICHIESTA

Verniciatura in una tinta della tabella colori  
Brem con fissaggi B35 colorati +15/25%  
Versione elettrica, a richiesta

## ATTACCHI DI SERIE

REG ø 1/2"  
A richiesta attacchi ø 3/8"  
Attacchi speciali, pag.279

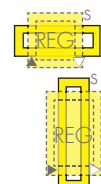

INTERASSE ATTACCHI

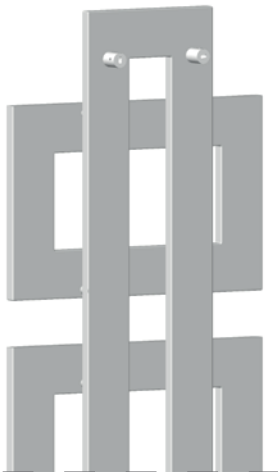
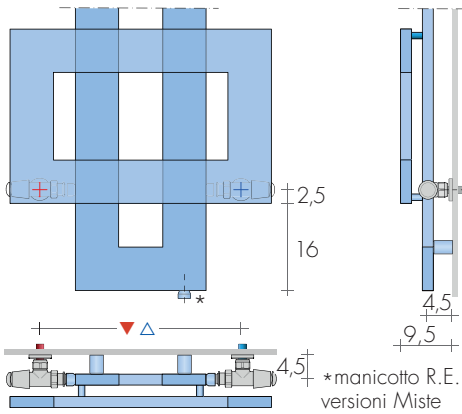

**FISSAGGI**  
Mensole comprese  
posizione pag. 65



CROSS-RV 184-56

VALVOLE CONSIGLIATE

KIT VALVOLE CROMATE comprende:

- n°2 Valvole con codoli
- n°2 Raccordi (per multistrato ø16 e rame ø12 e 14)
- n°2 Rosette tonde cromo ø 48, foro ø16

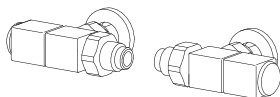

KIT VALVOLE QUADRA REVERSE  
pag.271 Art. KQR 166,80€  
Colore tabella BREM supplemento 49,50€

FINITURE SPECIALI: Oro, Bronzo, Nickel spazzolato, Foglia O/A per 2 valvole pag. 267  
KIT Raccordi NICKEL spazz. suppl.Art. RN 28,20€

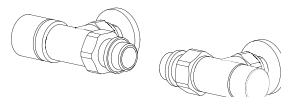

KIT VALVOLE CYL termostattabile REVERSA  
pag. 273 Art. KCR 138,80€  
Colore tabella BREM supplemento 49,50€

ATTACCHI REMOTI Art. REM 37,60€  
modelli verticali, interasse ▲▼ L<sup>1</sup> - 6 cm  
modelli orizzontali, interasse ▲▼ L - 6 cm  
Valvole REMOTE pag. 274

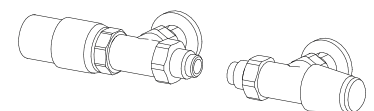
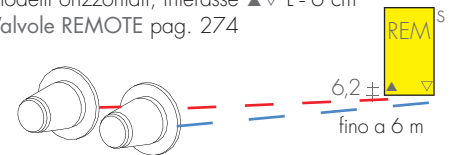

KIT VALVOLE TON REVERSE con TESTA TERMOSTATICA, pag. 269 Art. KTR 176,20€

design Luigi Brebbia

ESSEN: uno scaldasalviette dalla geometria elementare realizzato con una sola sezione

tubolare per ottenere un'estetica intrigante e grande funzionalità. Una grande cornice a

sezione rettangolare sostituisce i soliti collettori e permette di aumentare le rese caloriche.

## DIMENSIONI

Larghezze 40 / 52 / 64 / 126 cm

Altezze 72 / 104 / 128 / 136 / 168 / 200 cm

Profondità: 2 cm. Essen Plus 8,5 cm

Sporgenza dal muro: 9 cm. Essen Plus 10 cm

ESSEN PLUS con tubi radianti sul retro

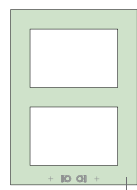

ESSEN 72..

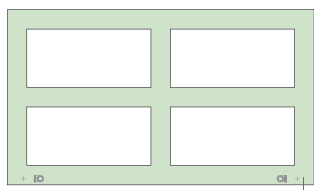

ESSEN 72-126

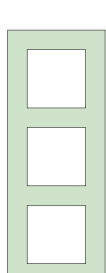

ESSEN 104..

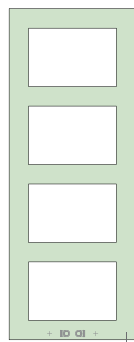

ESSEN 136..

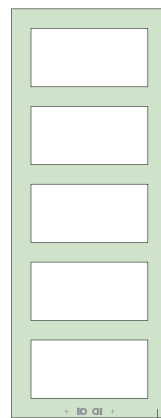

ESSEN 168..

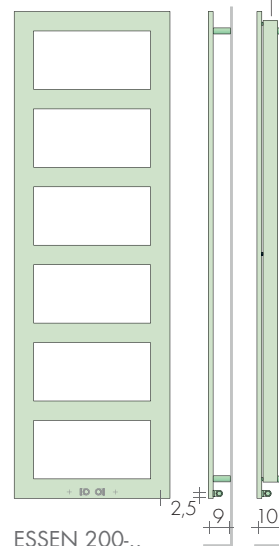

ESSEN 200..

## MODELLO

MODELLO	H-L cm	Bianco di serie sablé SB 9016 €	EN442			▲ ▼ int.att. cm	Altezza H cm	larghezza L cm	Peso M Kg	Volume V dm³	VERSIONI MISTE con Resistenza e manicotto	
			Δt 50K watt	Δt 40K watt	Δt 30K watt						Watt	€
ESSEN	72-40	564,40	238	180	125	19	72	40	4,7	2,8	250	115,10
ESSEN	72-52	587,20	277	209	146	19	72	52	5,4	3,3	300	116,10
ESSEN PLUS	72-52	734,00	420	319	221	19	72	52	8,9	5,5	400	117,20
ESSEN	72-126	842,20	575	439	303	112	72	126	11,3	6,8	650	121,30
ESSEN	104-52	652,20	387	292	204	19	104	52	7,6	4,6	400	117,20
ESSEN PLUS	104-40	739,30	519	332	274	19	104	40	11,1	6,8	500	119,30
ESSEN	136-40	703,50	431	325	227	19	136	40	8,5	5,1	400	117,20
ESSEN	136-52	734,40	497	375	262	19	136	52	9,8	5,9	500	119,30
ESSEN PLUS	136-40	954,60	668	504	352	19	136	40	14,2	8,8	650	121,30
ESSEN PLUS	136-52	1056,70	743	571	392	19	136	52	15,8	9,7	800	125,70
ESSEN PLUS	136-64	1073,60	819	625	432	19	136	64	17,3	10,7	900	129,00
ESSEN	168-40	830,60	528	399	278	19	168	40	10,4	6,3	500	119,30
ESSEN	168-52	868,20	607	458	320	19	168	52	11,9	7,2	650	121,30
ESSEN	168-64	886,50	686	518	362	19	168	64	13,5	8,2	650	121,30
ESSEN PLUS	168-40	1073,80	816	616	430	19	168	40	17,4	10,7	800	125,70
ESSEN PLUS	168-52	1171,90	905	701	477	19	168	52	19,2	11,8	900	129,00
ESSEN	200-40	966,50	625	472	329	19	200	40	12,3	7,4	650	121,30
ESSEN	200-64	1006,70	810	612	427	19	200	64	15,9	9,6	800	125,70
VERSIONE CROMATA												
ESSEN CROM	104-52	1434,30	333	251	175	19	104	52	7,6	4,6	300	116,10
ESSEN CROM	136-52	1722,10	427	322	225	19	136	52	9,8	5,9	400	117,20
ESSEN CROM	168-52	1909,50	522	394	275	19	168	52	11,9	7,2	500	119,30
ESSEN CROM	168-64	2152,30	590	445	311	19	168	64	13,5	8,2	650	121,30

FINITURA IN FOGLIA DORATA/ARGENTO

Supplemento: il prezzo standard x 1,05

Pronta consegna

Termostati p.208-209

## ESECUZIONI DI SERIE

Colore bianco sablé SB9016 mensole B..

Tolleranze ± 3mm - Valvola di sfianto ø 1/8"

PRESSIONE MASSIMA D'ESERCIZIO 4 BAR

## ESECUZIONI A RICHIESTA

Verniciatura in una tinta della tabella colori

Brem con fissaggi colorati

Versione elettrica e.Essen, pag. 225

## ATTACCHI DI SERIE REG ø 1/2"

A richiesta: ESSEN con sporgenza

di 5,5 cm e attacchi EG ø 3/8"

Attacchi speciali, pag. 279



INTERASSE ATTACCHI

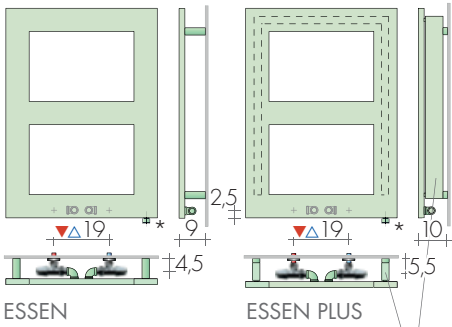

\* manicotto R.E. versioni Miste

tubi radianti sul retro

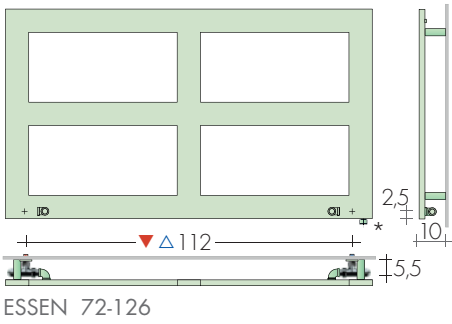

ESSEN 72-126

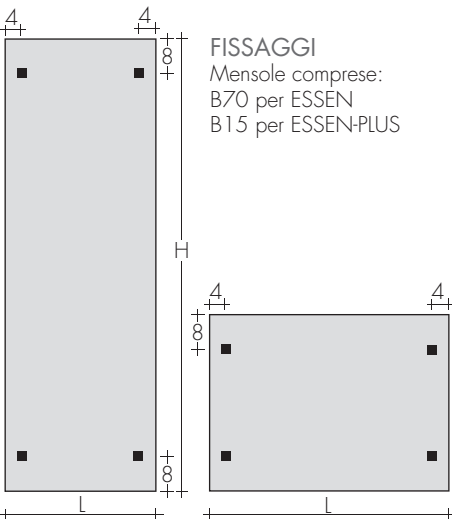

FISSAGGI

Mensole comprese:  
B70 per ESSEN  
B15 per ESSEN-PLUS



ESSEN 168-52

ESSEN PLUS 168-52

CrossFRAME

VALVOLE CONSIGLIATE

KIT VALVOLE CROMATE comprende:

- n°2 Valvole con codoli
- n°2 Raccordi (per multistrato ø16 e rame ø12 e 14)
- n°2 Rosette tonde cromo ø 48, foro ø16

FINITURE SPECIALI: Oro, Bronzo, Nickel spazzolato, Foglia O/A per 2 valvole pag. 267  
KIT Raccordi NICKEL spazz. suppl.Art. RN 28,20€

ATTACCHI REMOTI Art. REM 37,60€  
Interasse attacchi sul retro: ▲▼ L - 6 cm  
Valvole REMOTE pag. 274

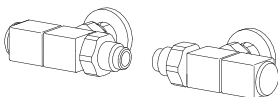
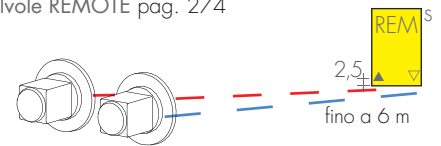

KIT VALVOLE QUADRA REVERSE pag.271 Art. KQR 166,80€  
Colore tabella BREM supplemento 49,50€

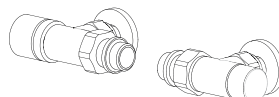

KIT VALVOLE CYL termostattabile REVERSA pag. 273 Art. KCR 138,80€  
Colore tabella BREM supplemento 49,50€

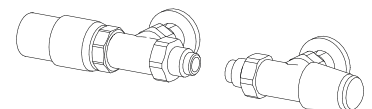

KIT VALVOLE TON REVERSE con TESTA TERMOSTATICA, pag. 269 Art. KTR 176,20€

design Luigi Brembilla

FIT è uno scaldasalviette dalla geometria elementare realizzato con una sola sezione

tubolare resa più fitta per ottenere maggiore resa termica e più funzionalità.

Una maggiore distribuzione di tubi a sezione rettangolare definisce un design alternativo.

## DIMENSIONI

Larghezze: 28 / 40 / 48 / 56 / 64 cm  
 Altezze: 88 / 108 / 128 / 148 / 168 / 188 cm  
 Profondità: 2 cm  
 Sporgenza dal muro: 9 cm

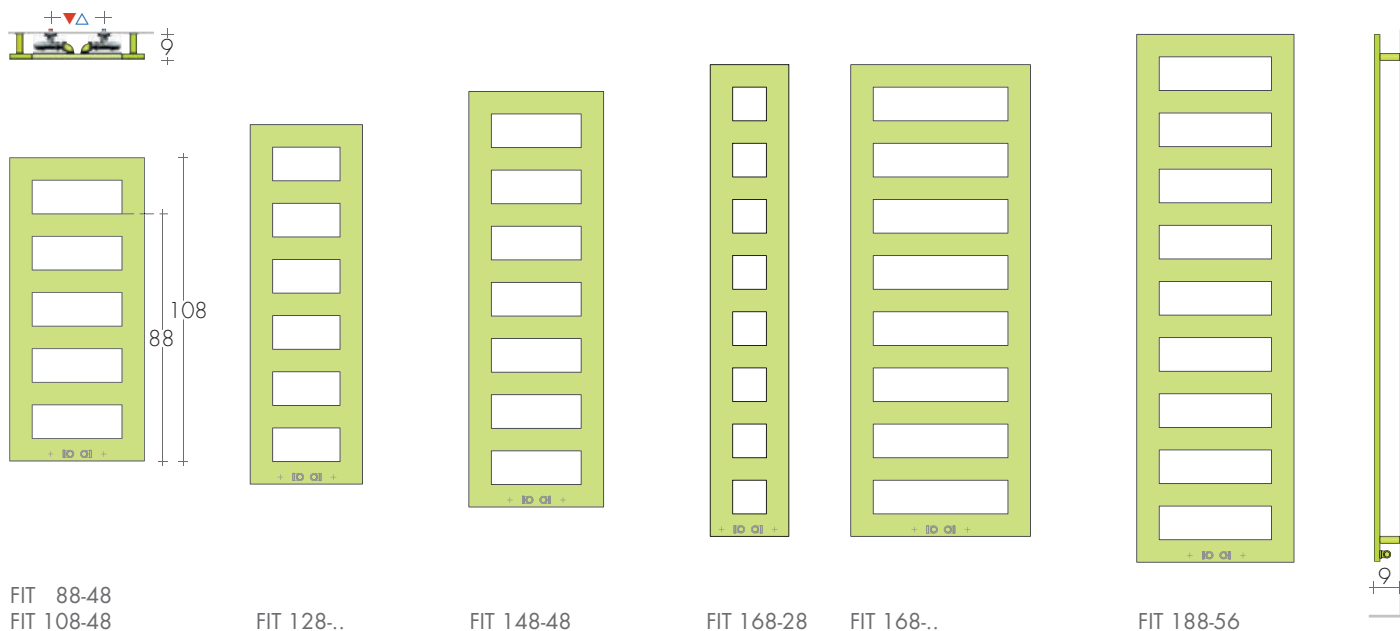

FIT 88-48  
FIT 108-48

FIT 128-40

FIT 148-48

FIT 168-28

FIT 168-40

FIT 188-56

MODELLO	HL cm	Bianco di serie sablé SB 9016 €	EN442			▲▼ int.att. cm	Altezza H cm	Larghezza L cm	Peso M Kg	Volume V dm <sup>3</sup>	VERSIONI MISTE con Resistenza e manicotto	
			Δt 50K watt	Δt 40K watt	Δt 30K watt						Watt	€
FIT	88-48	628,80	393	296	206	19	88	48	7,3	4,4	400	117,20
FIT	108-48	667,80	477	359	249	19	108	48	8,8	5,3	500	119,30
FIT	128-40	694,40	496	373	259	19	128	40	9,2	5,6	500	119,30
FIT	128-56	783,80	627	472	328	19	128	56	11,6	7,0	650	121,30
FIT	148-48	807,50	646	486	338	19	148	48	11,9	7,2	650	121,30
FIT	168-28	812,00	519	391	271	19	168	28	9,6	5,8	500	119,30
FIT	168-40	839,80	646	486	338	19	168	40	11,9	7,2	650	121,30
FIT	168-56	895,40	814	613	426	19	168	56	15,0	9,1	800	125,70
FIT	168-64	908,00	899	677	470	19	168	64	16,6	10,1	900	129,00
FIT	188-56	953,40	908	684	475	19	188	56	16,8	10,2	900	129,00

FINITURA IN FOGLIA DORATA/ARGENTO  
 Supplemento: il prezzo standard x 1,05

Termostati p.208-209

## ESECUZIONI DI SERIE

Colore bianco sablé SB9016 mensole B70  
 Tolleranze ± 3mm - Valvola di sfianto ø 1/8"  
 PRESSIONE MASSIMA D'ESERCIZIO 4 BAR

## ESECUZIONI A RICHIESTA

Verniciatura in una tinta della tabella colori  
 Brem con fissaggi B70 colorati +1.5/25%  
 Versione elettrica e.Fit, pag. 226

## ATTACCHI DI SERIE REG ø 1/2"

A richiesta: FIT con sporgenza  
 di 5,5 cm e attacchi EG ø 3/8"  
 Attacchi speciali, pag. 279



INTERASSE ATTACCHI

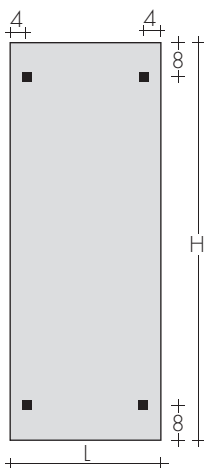
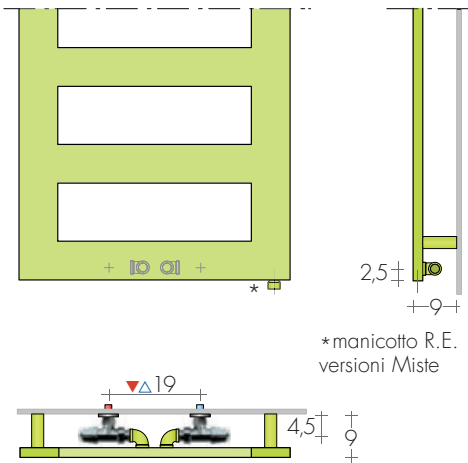

FISSAGGI  
Mensole B70 comprese.

VALVOLE CONSIGLIATE

KIT VALVOLE CROMATE comprende:

- n°2 Valvole con codoli
- n°2 Raccordi (per multistrato ø16 e rame ø12 e 14)
- n°2 Rosette tonde cromo ø 48, foro ø16

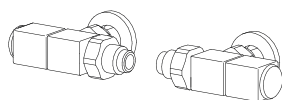

KIT VALVOLE QUADRA REVERSE  
pag. 271 Art. KQR 166,80€  
Colore tabella BREM supplemento 49,50€

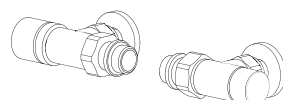

KIT VALVOLE CYL termostattabile REVERSA  
pag. 273 Art. KCR 138,80€  
Colore tabella BREM supplemento 49,50€

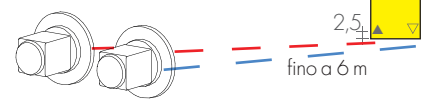

ATTACCHI REMOTI Art. REM 37,60€  
Interasse attacchi sul retro: ▲▼ L - 6 cm  
KIT Raccordi NICKEL spazz. suppl. Art. RN 28,20€  
Valvole REMOTE pag. 274

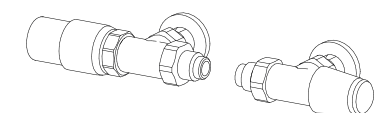

KIT VALVOLE TON REVERSE con TESTA TERMO-  
STATICA, pag. 269 Art. KTR 176,20€



design Luigi Brembilla

FREE è un maniglione riscaldante in tubo rettangolare da fissare con tanta flessibilità ed

in modo libero sulla parete. Può essere usato solo o abbinato a caloriferi con sporgenza

massima di 6 cm. Ad esempio: Clak, Egon, Form, Cross-V, Cross-G.

## DIMENSIONI

Larghezze: 54/64/84/104/124/144/164 cm

Altezza: 24 cm

Profondità / Sporgenza: 12 cm

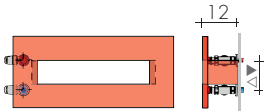
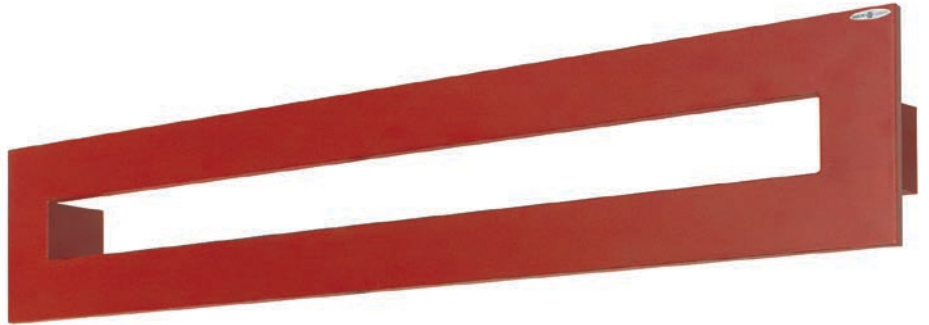

FREE 24-54

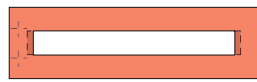

FREE 24-84

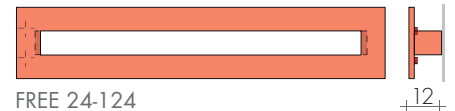

FREE 24-124

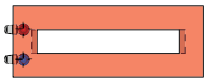

FREE 24-64

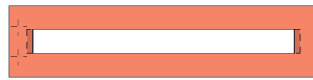

FREE 24-104

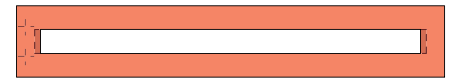

FREE 24-144 / 24-164

MODELLO	Hl cm	Bianco di serie sablé SB 9016 €	EN 442			▲▼ int.att. cm	Altezza H cm	Larghezza L cm	Peso M Kg	Volume V dm <sup>3</sup>	VERSIONI MISTE con Resistenza e manicotto	
			Δt 50K watt	Δt 40K watt	Δt 30K watt						Watt	€
FREE	24-54	298,00	130	95	68	10	24	54	2,6	1,7	-	-
FREE	24-64	314,00	158	119	83	10	24	64	3,0	1,9	-	-
FREE	24-84	350,20	202	153	106	10	24	84	3,9	2,4	250	115,10
FREE	24-104	386,40	246	186	129	10	24	104	4,7	2,9	250	116,10
FREE	24-124	422,60	290	219	153	10	24	124	5,5	3,5	300	116,10
FREE	24-144	458,90	334	252	176	10	24	144	6,4	4,0	300	116,10
FREE	24-164	495,20	378	285	199	10	24	164	7,3	4,5	400	117,20

Pronta consegna

Termostati p.208-209

### Versione ELETTRICA / MISTA

POSIZIONE RESISTENZA

Resistenza orizzontale in (D)

A richiesta resistenza a sinistra



### ESECUZIONI DI SERIE

Colore bianco sablé SB9016 con fissaggi  
Tolleranze ± 3mm - Valvola di sfizio ø 1/8"  
PRESSIONE MASSIMA D'ESERCIZIO 4 BAR

### ESECUZIONI A RICHIESTA

Colori Brem con fissaggi colorati +15/25%  
Altre misure a richiesta  
Versione elettrica eFree, pag.229

### ATTACCHI DI SERIE

AC ø 1/2"  
A richiesta attacchi ø 3/8"  
Attacchi speciali, pag.279



INTERASSE ATTACCHI

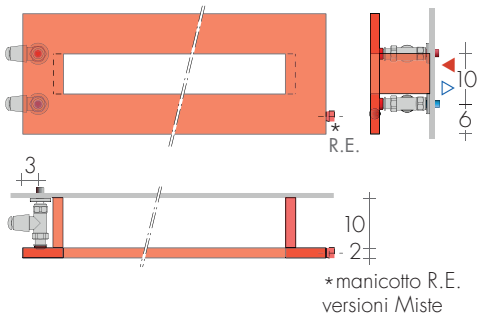

A richiesta attacchi a destra o su misura.

FISSAGGI

Mensole comprese

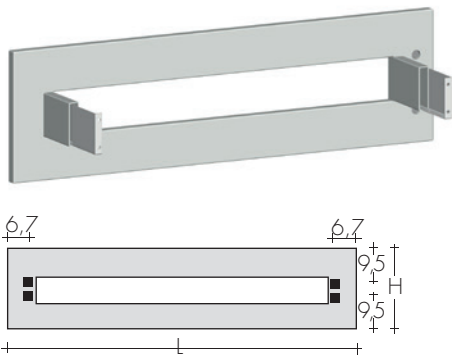

VALVOLE CONSIGLIATE

KIT VALVOLE CROMATE comprende:

- n°2 Valvole con codoli
- n°2 Raccordi (per multistrato ø16 e rame ø12 e 14)
- n°2 Rosette tonde cromo ø 48, foro ø16

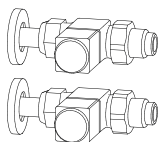

KIT VALVOLE mod. QUADRA DIRITTE

pag.271

Art. KQD

176,00€

Colore tabella BREM

supplemento 49,50€

FINITURE SPECIALI: Oro, Bronzo, Nickel spazzolato, Foglia O/A per 2 valvole pag. 267

KIT Raccordi NICKEL spazz. suppl.Art. RN 28,20€

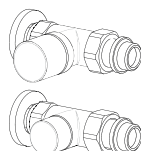

KIT VALVOLA CYL termostatabile DIRITTA

pag.273

Art. KCD

147,00€

Colore tabella BREM

supplemento 49,50€

ATTACCHI REMOTI Art. REM 37,60€

Interasse attacchi sul retro: AC interasse ▲▽ 10cm

Valvole REMOTE pag. 274

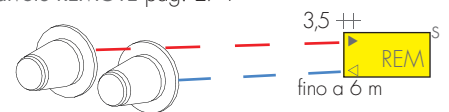

KIT VALVOLE mod. TON DIRITTE con testa

TERMOSTATICA, p. 269 Art. KTD 187,50€



FREE 24-104

design Luigi Brebbia

Kore PLUS, un elegante ed essenziale cornice, addizionata da un profilo sul retro

per potenziare le rese termiche. Di serie i modelli verticali sono ulteriormente impreziositi

con tubi radianti per alloggiare le salviette. Grande e insolito l'effetto d'arredamento.

## DIMENSIONI

Larghezze 54 / 124 cm  
 Altezze 55 / 98 / 140 / 180 cm  
 Profondità 8 cm  
 Sporgenza dal muro 9,5 cm

CrossFRAME

KORE-P con tubi radianti sul retro

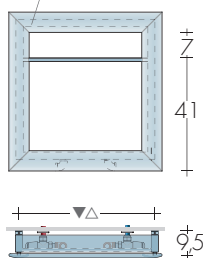

KORE-P 55 - 54

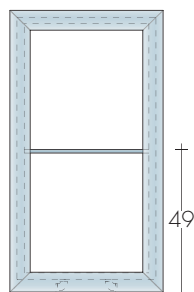

KORE-P 98 - 54

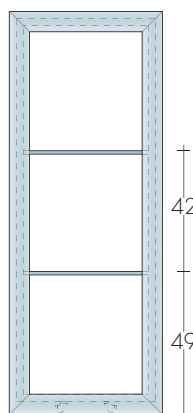

KORE-P 140 - 54

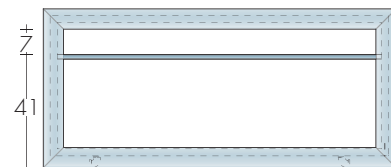

KORE-P 55 - 124

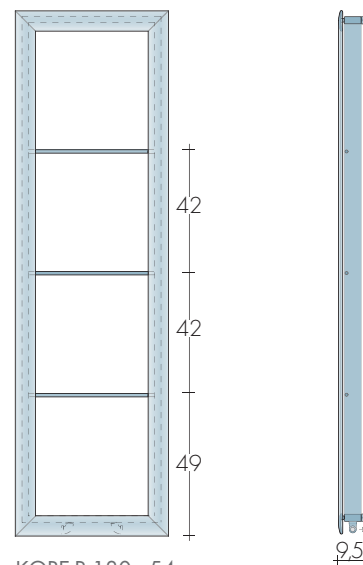

KORE-P 180 - 54

MODELLO	H/L cm	Bianco di serie sablé SB 9016 €	Δt 50K watt	EN 442 Δt 40K watt	Δt 30K watt	▲ ▼ int.att. cm	Altezza H cm	Larghezza L cm	Peso M Kg	Volume V dm <sup>3</sup>	VERSIONI MISTE con Resistenza e manicotto Watt €	
KORE-P	55-124	588,20	464	349	243	100	55	124	11,7	5,6	500	119,30
KORE-P	55-54	440,40	266	200	139	30	55	54	6,7	3,2	300	116,30
KORE-P	98-54	506,90	388	292	203	30	98	54	9,8	4,6	400	117,20
KORE-P	140-54	613,50	507	382	265	30	140	54	12,8	6,1	500	119,30
KORE-P	180-54	659,70	621	468	325	30	180	54	15,7	7,4	650	121,30

\* Aggiungere: Valvola mista o TR p.207  
 Termostati p.208-209

PRESSIONE MINIMA DI ESERCIZIO 1,5 BAR

## ESECUZIONI DI SERIE

Colore bianco sablé SB 9016 mensola B15  
 Tolleranze ± 3mm - Valvola di sfioro ø 1/8"  
 PRESSIONE MASSIMA D'ESERCIZIO 3 BAR

## ESECUZIONI A RICHIESTA

Verniciatura in una tinta della tabella colori  
 Brem con mensola B15 colorate +15/25%  
 Versione elettrica e.Kore Plus, pag. 237

## ATTACCHI DI SERIE

REG ø 1/2"  
 A richiesta attacchi ø 3/8"  
 Attacchi speciali, pag.279



## INTERASSE ATTACCHI

KORE PLUS attacchi con valvole reverse  $\varnothing$  1/2"

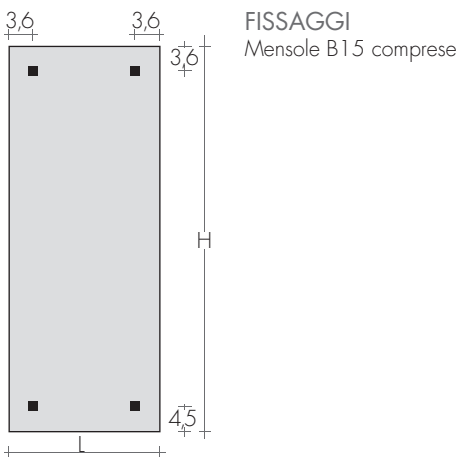
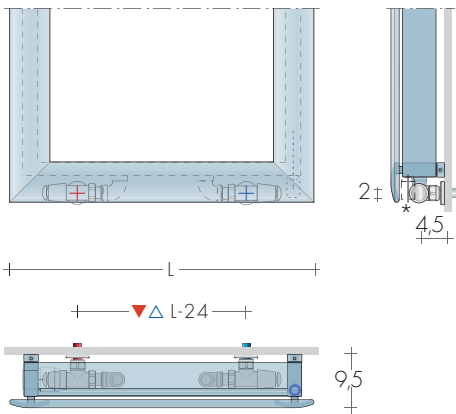

KORE-P 140-54

## VALVOLE CONSIGLIATE

KIT VALVOLE CROMATE comprende:

- n°2 Valvole con codoli
- n°2 Raccordi (per multistrato  $\varnothing$ 16 e rame  $\varnothing$ 12 e 14)
- n°2 Rosette tonde cromo  $\varnothing$  48, foro  $\varnothing$ 16

FINITURE SPECIALI

pag. 267

Finiture Oro, Bronzo, Nickel spazzolato per 2 valvole

KIT Raccordi NICKEL spazz. suppl.Art. RN 28,20€

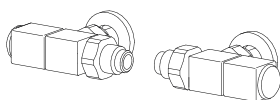

KIT VALVOLE QUADRA REVERSE

pag.271

Art. KQR

166,80€

Colore tabella BREM

supplemento

49,50€

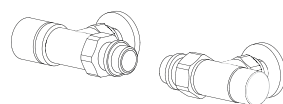

KIT VALVOLE CYL termostattabile REVERSA

pag. 273

Art. KCR

138,80€

Colore tabella BREM

supplemento

49,50€

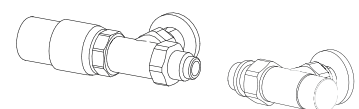

KIT VALVOLE CYL REVERSE con TESTA TERMO-

STATICA, pag. 273, 266

Art. KCTR

169,80€

Colore tabella BREM

supplemento

49,50€

design Pietro Facheris

PIT, un termoarredo dal design elegante ed essenziale con due o tre rettangoli radianti

sovrapposti tra loro. Lo spazio è ottimizzato moltiplicando la resa calorica e le sezioni

rettangolari creano tre diversi punti di appoggio per le salviette.

## DIMENSIONI

Larghezza: 32/40/48/56 / 126cm

Altezza: 60/72/99/132/176 cm

Profondità: 4,5 / 8 cm

Sporgenza dal muro: 11,5 cm

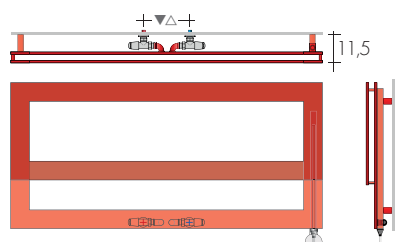

PIT 60-126

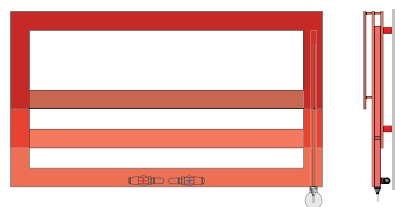

PIT 72-126

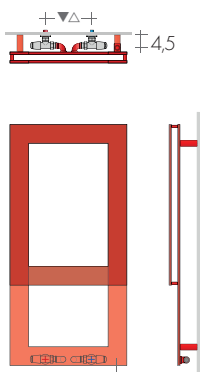

PIT 99..

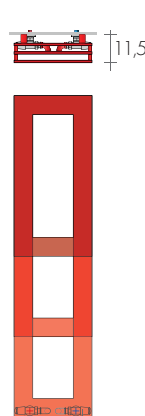

PIT 132-32

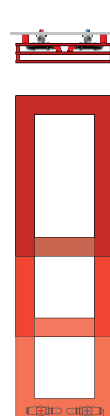

PIT 132..

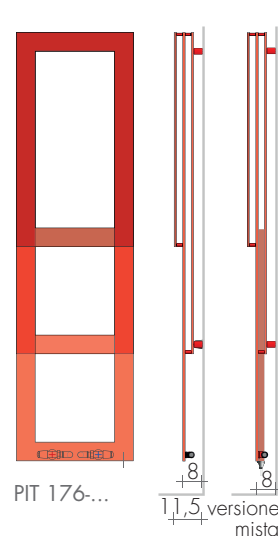

PIT 176...

1,5 versione mista

MODELLO	H/L cm	Bianco di serie sablé SB 9016 €	Δt 50K watt	EN442 Δt 40K watt	Δt 30K watt	▲▼ int.att. cm	Altezza H cm	Larghezza L cm	Peso M Kg	Volume V dm³	VERSIONI MISTE con Resistenza e collettore	
											Watt	€
PIT	60-126	883,30	588	444	310	19	60	126	11,7	3,5	650	193,10
PIT	72-126	1080,20	900	680	474	19	72	126	17,8	5,5	900	200,80
PIT	99-40	615,00	369	279	194	19	99	40	7,7	2,3	400	189,00
PIT	99-48	665,50	403	304	212	19	99	48	8,3	2,5	400	189,00
PIT	132-32	876,00	567	428	298	19	132	32	12,3	3,7	500	191,10
PIT	132-40	906,60	613	463	323	19	132	40	13,2	4,0	650	193,10
PIT	132-48	937,00	660	498	347	19	132	48	14,0	4,2	650	193,10
PIT	176-32	1011,90	750	566	395	19	176	32	16,0	4,8	800	197,50
PIT	176-40	1042,40	796	601	419	19	176	40	16,9	5,1	800	197,50
PIT	176-48	1073,00	843	636	444	19	176	48	17,8	5,3	900	200,80
PIT	176-56	1107,00	889	671	468	19	176	56	18,6	5,6	900	200,80

► Pronta consegna

Termostati p.208-209

## ESECUZIONI DI SERIE

Colore bianco sablé SB9016 mensola B.  
Tolleranze ± 3mm - Valvola di sfogo ø 1/8"  
PRESSIONE MASSIMA D'ESERCIZIO 4 BAR

## ESECUZIONI A RICHIESTA

Verniciatura in una tinta della tabella colori  
Brem con fissaggi B.. colorati +15/25%  
Versione elettrica, e.PIT pag.248

## ATTACCHI DI SERIE

REG ø 1/2"  
Attacchi speciali, pag.279



INTERASSE ATTACCHI

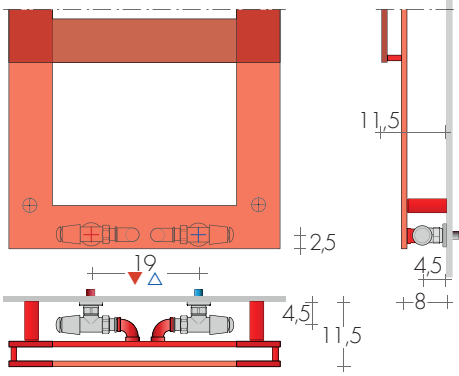

VERSIONI MISTE modelli verticali# solo con attacchi EG ▲▽5cm e valvole a squadra

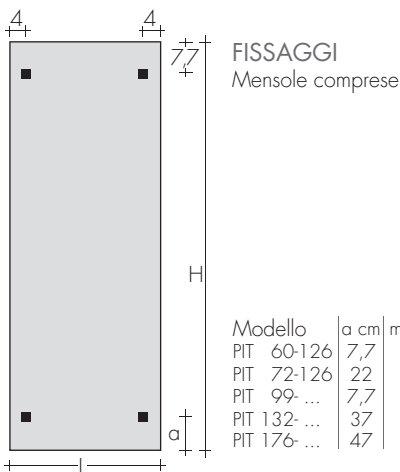
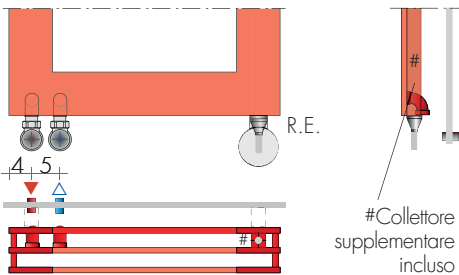

FISSAGGI  
Mensole comprese

Modello	a cm	mensole
PIT 60-126	7,7	B70
PIT 72-126	22	B35
PIT 99-...	7,7	B70
PIT 132-...	37	B35
PIT 176-...	47	B35



PIT 176-40

CrossFRAME

VALVOLE CONSIGLIATE

KIT VALVOLE CROMATE comprende:

- n°2 Valvole con codoli
- n°2 Raccordi (per multistrato ø16 e rame ø12 e 14)
- n°2 Rosette tonde cromo ø 48, foro ø16

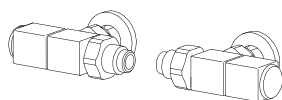

KIT VALVOLE QUADRA REVERSE  
pag. 271 Art. KQR 166,80€  
Colore tabella BREM supplemento 49,50€

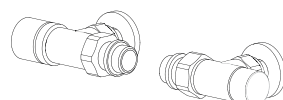

KIT VALVOLE CYL termostattabile REVERSA  
pag. 273 Art. KCR 138,80€  
Colore tabella BREM supplemento 49,50€

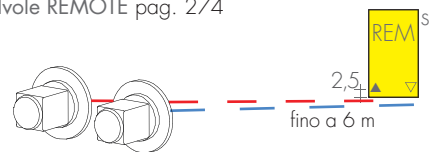

ATTACCHI REMOTI Art. REM 37,60€

FINITURE SPECIALI pag. 267

Finiture Oro, Bronzo, Nickel spazzolato per 2 valvole

KIT Raccordi NICKEL spazz. suppl. Art. RN 28,20€

Valvole REMOTE pag. 274

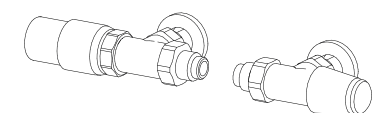

KIT VALVOLE TON REVERSE con TESTA TERMO-STATICA, pag. 269 Art. KTR 176,20€

design Luigi Brembilla

QUAR: uno scaldasalviette originale dalla elementare espressione geometrica.

In QUAR il tubo non è più tondo ma a sezione quadra. Una grande cornice a sezione

rettangolare sostituisce i soliti collettori e permette di aumentare le rese caloriche.

## DIMENSIONI

Larghezze 30,5 / 38,5 / 46,5 / 54,5 / 62,5 cm

Altezze 97,5 / 127,5 / 157,5 / 180 cm

Profondità: 2 cm. Quar-P 8,5 cm

Sporgenza dal muro: 9 cm. Quar-P 10 cm

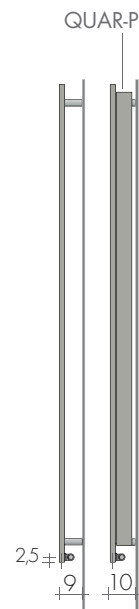
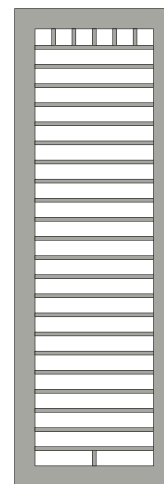
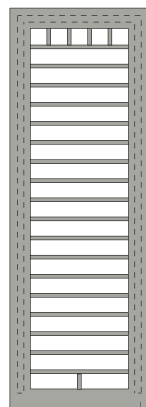
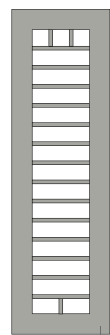
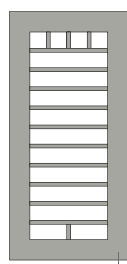
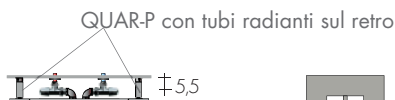
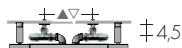

QUAR 97-..

QUAR 127-..

QUAR.. 157-..

QUAR.. 180-30

QUAR.. 180-..

MODELLO	H-L cm	Bianco di serie sablé SB 9016 €	EN442			▲▽ inf.att. cm	Altezza H cm	Larghezza L cm	Peso M Kg	Volume V dm³	VERSIONI MISTE con Resistenza e manicotto	
			Δt 50 K watt	Δt 40 K watt	Δt 30 K watt						Watt	€
QUAR	97-46	775,10	364	276	193	19	97,5	46,5	6,7	3,9	400	117,20
QUAR	97-54	789,90	403	306	214	19	97,5	54,5	7,4	4,2	400	117,20
QUAR	127-38	819,20	415	315	220	19	127,5	38,5	7,7	4,5	400	117,20
QUAR	127-46	836,20	463	351	245	19	127,5	46,5	8,5	4,9	500	119,30
QUAR	127-54	852,60	510	387	270	19	127,5	54,5	9,4	5,3	500	119,30
QUAR	157-38	908,90	506	384	268	19	157,5	38,5	9,4	5,4	500	119,30
QUAR	157-54	947,20	617	468	327	19	157,5	54,5	11,3	6,3	650	121,30
QUAR	157-62	966,90	673	511	357	19	157,5	62,5	12,3	6,8	650	121,30
QUAR-P	157-46	1157,10	832	631	441	19	157,5	46,5	17,0	10,1	800	125,70
QUAR-P	157-54	1176,80	895	679	474	19	157,5	54,5	18,1	10,6	900	129,00
QUAR	180-30	990,50	512	389	271	19	180	30,5	9,6	5,6	500	119,30
QUAR	180-46	1032,60	637	483	338	19	180	46,5	11,7	6,6	650	121,30
QUAR	180-54	1054,00	699	531	370	19	180	54,5	12,8	7,1	650	121,30
QUAR	180-62	1075,50	761	578	403	19	180	62,5	13,9	7,6	800	125,70
QUAR-P	180-30	1220,20	808	613	428	19	180	30,5	16,8	10,2	800	125,70
QUAR-P	180-38	1239,90	877	666	465	19	180	38,5	18,1	10,8	900	129,00
QUAR-P	180-62	1305,20	1091	828	578	19	180	62,5	22,0	12,7	1200	136,70

Termostati p.208-209

## ESECUZIONI DI SERIE

Colore bianco sablé SB9016 mensole bianche  
Tolleranze ± 3mm - Valvola di sfiato ø 1/8"  
PRESSIONE MASSIMA D'ESERCIZIO 4 BAR

## ESECUZIONI A RICHIESTA

Verniciatura in una tinta della tabella colori  
Brem con fissaggi colorati +15/25%  
Versione elettrica e. Quar, pag. 253

## ATTACCHI DI SERIE REG ø 1/2"

A richiesta: QUAR con sporgenza  
di 5,5 cm e attacchi EG ø 3/8"  
Attacchi speciali, pag.279



INTERASSE ATTACCHI

MOD. QUAR

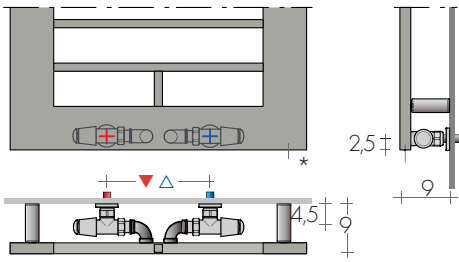

\*manicotto R.E.  
versioni Miste

MOD. QUAR-P

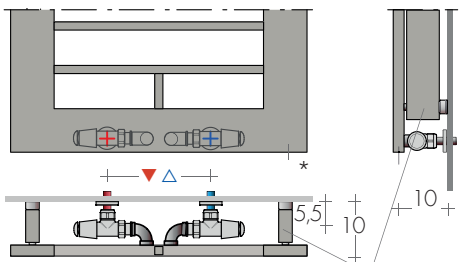

QUAR-P  
con tubi radianti sul retro

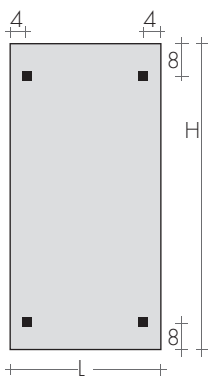

FISSAGGI  
Mensole comprese:  
B70 per QUAR  
B15 per QUAR-P



QUAR 127-46

CrossFRAME

VALVOLE CONSIGLIATE

KIT VALVOLE CROMATE comprende:

- n°2 Valvole con codoli
- n°2 Raccordi (per multistrato ø16 e rame ø12 e 14)
- n°2 Rosette tonde cromo ø 48, foro ø16

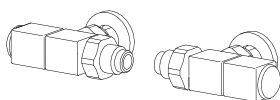

KIT VALVOLE QUADRA REVERSE  
pag.271 Art. KQR 166,80€  
Colore tabella BREM supplemento 49,50€

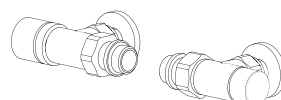

KIT VALVOLE CYL termostattizzabile REVERSA  
pag. 273 Art. KCR 138,80€  
Colore tabella BREM supplemento 49,50€

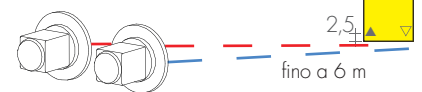

ATTACCHI REMOTI Art. REM 37,60€

FINITURE SPECIALI pag. 267

Finiture Oro, Bronzo, Nickel spazzolato per 2 valvole

KIT Raccordi NICKEL spazz. suppl.Art. RN 28,20€

Interasse attacchi sul retro: ▲▼ L - 6cm

Valvole REMOTE pag. 274

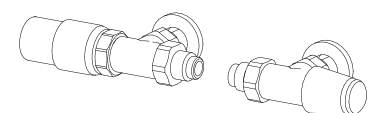

KIT VALVOLE TON REVERSE con TESTA TERMO-  
STATICA, pag. 269 Art. KTR 176,20€

design Luigi Brembilla

E' come affacciarsi a una finestra, o dall'alto di una scala. Spazi successivi che si restrin-

gono, che formano un quadro a volume, che vestono e scaldano. Vision si propone

così inaspettato in un ambiente che la funzione scaldante passa in secondo piano.

## DIMENSIONI

Larghezze: 48/56/64/80/96/112 cm

Altezze: 48/56/64/80/96/128 cm

Profondità: 12/14/22/24 cm

Sporgenza dal muro 15,5/17,5/25,5/27,5 cm

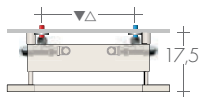

VISION-1

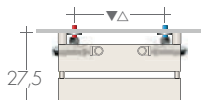

VISION-2

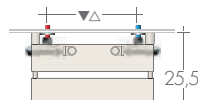

VISION-2ST

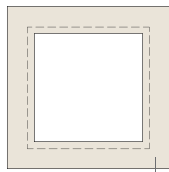

VISION.. 48-48  
VISION.. 56-56  
VISION.. 64-64



VISION.. 48-80  
VISION.. 48-96  
VISION.. 56-96  
VISION.. 56-112  
VISION.. 64-112

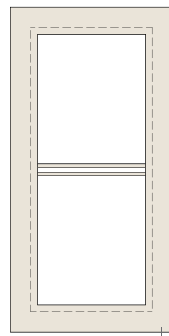

VISION..ST 80-48

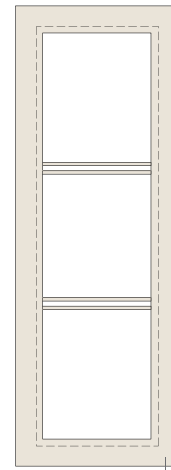

VISION..ST 128..

VISION-1ST VISION-2ST

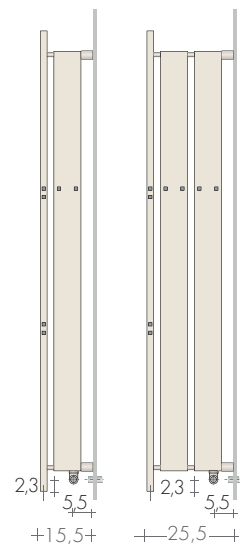

MODELLO	H-L cm	Bianco di serie sablé SB 9016 €	EN 442			▲ ▼ int.att. cm	Altezza H cm	Largh. L cm	Prof. P cm	Peso M Kg	Volume V dm³	VERSIONI MISTE con Resistenza e manicotto	
			Δt 50K watt	Δt 40K watt	Δt 30K watt							Watt	€
VISION-1	48-48	641,00	322	245	172	27	48	48	14	6,4	3,9	300	116,10
VISION-1	56-56	667,50	391	297	208	35	56	56	14	7,8	4,7	400	117,20
VISION-1	64-64	723,80	461	351	246	43	64	64	14	9,2	5,6	500	119,30
VISION-2	48-48	882,70	462	351	246	27	48	48	24	9,3	5,7	500	119,30
VISION-2	56-56	954,10	565	430	301	35	56	56	24	11,4	6,9	500	119,30
VISION-2	64-64	996,90	667	507	356	43	64	64	24	13,5	8,2	650	121,30
VISION-1	48-80	734,40	461	351	246	59	48	80	14	9,2	5,6	500	119,30
VISION-1	48-96	778,80	530	403	282	75	48	96	14	10,2	6,4	500	119,30
VISION-1	48-112	860,20	600	456	320	91	48	112	14	11,6	7,2	650	121,30
VISION-1	56-96	782,60	565	430	301	75	56	96	14	17,1	10,4	500	119,30
VISION-1	56-112	799,30	635	483	338	91	56	112	14	12,3	7,6	650	121,30
VISION-1	64-112	844,60	669	509	357	91	64	112	14	20,2	12,3	650	121,30
VISION-2	48-80	1016,90	667	507	356	59	48	80	24	13,5	8,2	650	121,30
VISION-2	56-96	1094,70	821	624	438	75	56	96	24	28,3	17,2	800	125,70
VISION-2	64-112	1169,60	975	741	520	91	64	112	24	33,5	20,3	900	129,00
VISION-1ST	80-48	835,70	475	361	251	27	80	48	12	9,2	5,6	500	119,30
VISION-1ST	128-48	990,80	709	539	378	27	128	48	12	13,5	8,3	650	121,30
VISION-1ST	128-56	1052,00	745	567	393	35	128	56	12	15,4	9,2	800	125,70
VISION-2ST	80-48	1171,60	681	518	360	27	80	48	22	13,5	8,2	650	121,30
VISION-2ST	128-48	1344,70	1015	772	541	27	128	48	22	19,7	12,2	900	129,00
VISION-2ST	128-56	1419,90	1067	811	563	35	128	56	22	22,4	13,5	1200	136,70

Termostati p.208-209

## ESECUZIONI DI SERIE

Colore bianco sablé SB9016 mensole B35  
Tolleranze ± 3mm - Valvola di sfianto ø 1/8"  
PRESSIONE MASSIMA D'ESERCIZIO 4 BAR

## ESECUZIONI A RICHIESTA

Verniciatura in una tinta della tabella colori  
Brem con fissaggi B35 colorati +15/25%  
Versione elettrica e.Vision, pag.262

## ATTACCHI DI SERIE

REG ø 1/2"  
A richiesta attacchi ø 3/8"  
Attacchi speciali, pag.279



## INTERASSE ATTACCHI

MOD. VISION

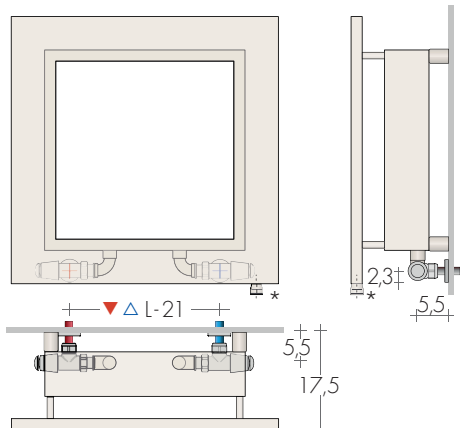

\*manicotto R.E.  
versioni Miste

MOD. VISION-ST

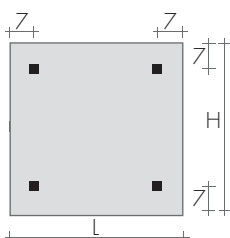
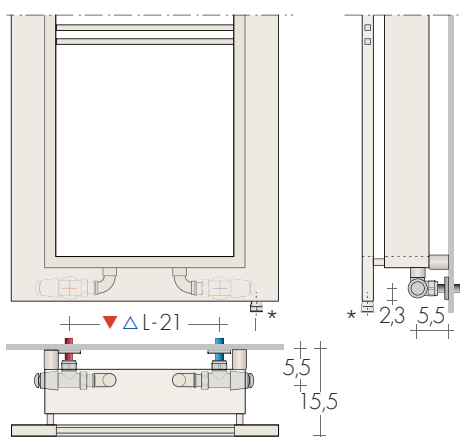

FISSAGGI  
Mensole comprese

## VALVOLE CONSIGLIATE

KIT VALVOLE CROMATE comprende:

- n°2 Valvole con codoli
- n°2 Raccordi (per multistrato  $\varnothing 16$  e rame  $\varnothing 12$  e  $14$ )
- n°2 Rosette tonde cromo  $\varnothing 48$ , foro  $\varnothing 16$

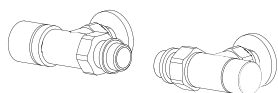

KIT VALVOLE CYL termostattabile REVERSA  
pag. 273 Art. KCR 138,80€  
Colore tabella BREM supplemento 49,50€  
KIT Raccordi NICKEL spazzolato Art.RN 28,20€

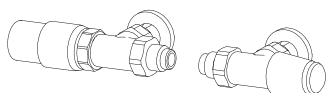

KIT VALVOLE TON REVERSE con TESTA TERMO-  
STATICA, pag. 269 Art. KTR 176,20€



VISION-1 48-48



VISION-2 ST 128-56



# INDEX PIASTRE

CALORIFERI A PIASTRA E TUBI PIATTI

## COLLEZIONE CALORIFERI

	pag.
CLAK	86
C-ProLux®	90
EGON	94
LAMINA	98
OPEN	102
PHUL	106
SO-FLEX	108
S-PLATT	110
SUIT	114

## COLLEZIONE SCALDASALVIETTE

	pag.
CAMEO	120
CLARK	122
CUBICO	124
DUO	126
FLAG	128
GEOMETRICA	130-132
HOT	134
LOGGIA D/T	136
MANT	138
PLATT COLOR	140
PLATT INOX	142
PLATT FO/FA	143
UNI-PLATT	144
VELETTA	146



LAMINA

CLAK

S-PLATT



CLAK, piastra extra sottile dall'estetica minimal e raffinata, è profonda solo 2,3 cm;

la versione con tubi sul retro è di soli 4,3 cm. La sporgenza dal muro con le valvole Brem

è limitata a 5,8 cm ed è riducibile solo utilizzando valvole diritte.

## DIMENSIONI PIASTRA VERTICALE

Larghezze: da 27 a 90 cm (ogni 9 cm)  
 Altezze: da 140 a 240 cm (ogni 20 cm)  
 Profondità: 2,3 cm e 4,3 cm  
 Sporgenza dal muro: da 5,8 cm

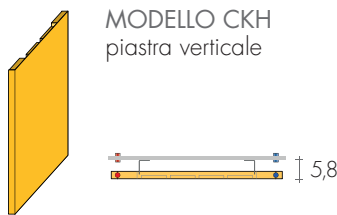

MODELLO CKH  
piastra verticale

CKH

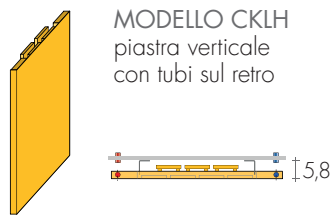

MODELLO CKLH  
piastra verticale  
con tubi sul retro

CKLH

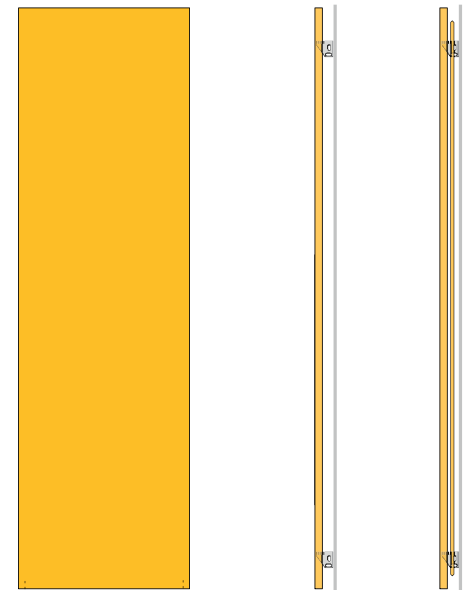

CKH ... CKLH ...

CKH

CKLH

EN 442 Watt Δt 50K (Δt 40K = Wx0,755) - (Δt 30K = Wx0,526)

Mod. CLAK	L cm	27	36	45	54	63	72	81	90
H cm	▲▽ i.a. cm	23	32	41	50	59	68	77	86
CKH 140	€	726,30 422w	797,90 556w	878,10 692w	957,30 828w	1031,90 962w	1107,00 1098w	1185,60 1234w	1262,00 1370w
CKLH 140	€	960,80 497w	1062,30 707w	1174,30 918w	1266,10 1129w	1371,70 1338w	1473,40 1550w	1578,40 1761w	1678,50 1972w
CKH 160	€	775,20 482w	853,90 635w	936,40 790w	1020,60 945w	1101,80 1098w	1181,70 1253w	1265,40 1408w	1346,60 1563w
CKLH 160	€	1014,60 568w	1120,10 808w	1225,90 1050w	1332,30 1291w	1440,40 1531w	1546,10 1773w	1653,90 2014w	1759,30 2256w
CKH 180	€	823,80 541w	909,70 713w	995,00 887w	1083,70 1061w	1171,40 1233w	1256,30 1407w	1345,40 1581w	1431,40 1755w
CKLH 180	€	1068,60 639w	1178,10 909w	1277,20 1181w	1398,80 1453w	1509,10 1723w	1618,80 1996w	1729,40 2268w	1839,80 2540w
CKH 200	€	868,60 601w	959,00 792w	1051,30 985w	1137,60 1178w	1228,90 1369w	1318,90 1562w	1409,00 1755w	1501,40 1948w
CKLH 200	€	1146,90 710w	1266,80 1011w	1384,70 1313w	1512,80 1616w	1622,80 1916w	1741,10 2219w	1859,70 2521w	1976,40 2824w
CKH 220	€	921,10 660w	1016,40 870w	1112,50 1082w	1221,00 1294w	1307,80 1504w	1404,00 1716w	1497,90 1928w	1596,50 2141w
CKLH 220	€	1192,60 781w	1317,50 1112w	1440,20 1445w	1573,50 1778w	1688,10 2109w	1810,60 2441w	1934,00 2774w	2055,50 3107w
CKH 240	€	987,60 720w	1091,50 949w	1195,10 1180w	1298,70 1411w	1402,40 1640w	1506,30 1871w	1609,90 2102w	1716,30 2333w
CKLH 240	€	1238,50 852w	1368,00 1213w	1495,50 1577w	1634,10 1940w	1753,20 2301w	1880,30 2664w	2008,20 3028w	2134,30 3391w

A richiesta dimensioni fuori tabella

Δt diversi da 50 K: consultare Dati tecnici Brem

ACCESSORI MAGNETICI pag. 277

## ORDINE

Indicare: modello se semplice o con tubi sul retro, altezza - larghezza, attacco e colore es.: CKH 180 - 36, EG ø 3/8", SB7035

## ESECUZIONI DI SERIE

Colore bianco sablé SB9016 - Mensola EOS  
 Tolleranze ± 3mm - Valvola di sfogo ø 1/8"  
 PRESSIONE MASSIMA D'ESERCIZIO 4 BAR

## ESECUZIONI A RICHIESTA

Verniciatura tabella colori Brem +15/25%  
 Finitura acciaio INOX a preventivo  
 Versione elettrica e.Clak pag.216

## ATTACCHI DI SERIE

EG ø 3/8"  
 A richiesta ø 1/2" con manicotti  
 Attacchi speciali, pag.278

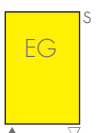

INTERASSE ATTACCHI EG 3/8" verticali

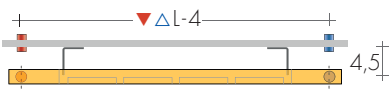
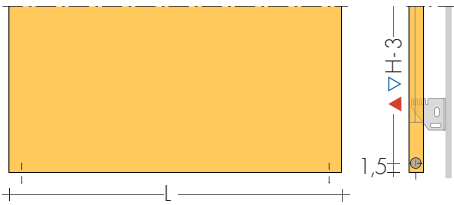

MODELLO CKH

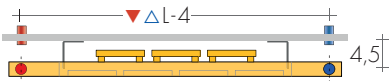

MODELLO CKLH

A richiesta attacchi laterali 3/8"  $\nabla$   $\triangle$  H - 3 cm  
 Supplemento Art. AS 81,40€



Attacchi  $\varnothing$  3/8"  
 DI SERIE  
 (a filo piastra)



Attacchi  $\varnothing$  1/2"  
 A RICHIESTA  
 (con manicotti)

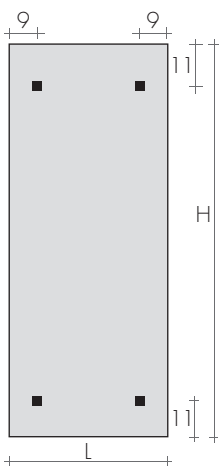

FISSAGGI  
 Mensole comprese



Mensola EOS



CLAK CKH 160-45

VALVOLE CONSIGLIATE

KIT VALVOLE CROMATE comprende:

- n°2 Valvole con codoli
- n°2 Raccordi (per multistrato  $\varnothing$ 16 e rame  $\varnothing$ 12 e 14)
- n°2 Rosette tonde cromo  $\varnothing$  48, foro  $\varnothing$ 16

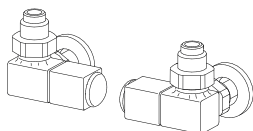

KIT VALVOLE QUADRA comando LATERALE  
 pag. 271 Art. KQL 177,10€  
 Colore tabella BREM supplemento 49,50€

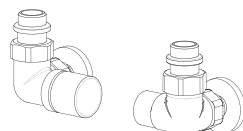

KIT VALVOLE CYL termostattabile con comando  
 LATERALE, pag.273 Art. KCL 150,50€  
 Colore tabella BREM supplemento 49,50€

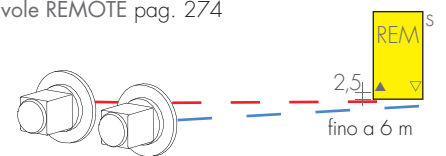

ATTACCHI REMOTI Art. REM 37,60€  
 Interasse attacchi sul retro:  $\triangle$   $\nabla$  L - 5 cm  
 Valvole REMOTE pag. 274

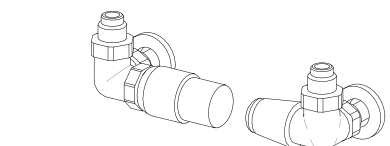

KIT VALVOLE TON comando LATERALE con Testa  
 TERMOSTATICA, pag. 269 Art. KTL 188,60€

CLAK, piastra extra sottile dall'estetica minimal e raffinata, è profonda solo 2,3 cm;

la versione con tubi sul retro è di soli 4,3cm. La sporgenza dal muro è limitata a 5,8 cm

con le valvole Brem ed è riducibile solo utilizzando valvole diritte.

## DIMENSIONI PIASTRA ORIZZONTALE

Larghezze: da 50 a 220 cm  
 Altezze: da 45 a 90 cm (ogni 9 cm)  
 Profondità: 2,3 cm e 4,3 cm  
 Sporgenza dal muro: da 5,8 cm



CKV



CKLV

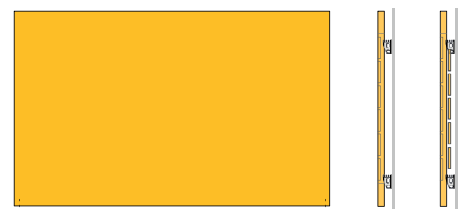

CKV ... CKLV ...

CKV CKLV

Mod. CLAK H cm	L cm	EN 442 Watt $\Delta t$ 50K ( $\Delta t$ 40K = $W \times 0,755$ ) - ( $\Delta t$ 30K = $W \times 0,526$ )											
		50	60	70	80	90	100	120	140	160	180	200	220
	$\Delta$ cm	47	57	67	77	87	97	117	137	157	177	197	217
CKV 45	€	760,80 253w	791,60 302w	815,50 351w	843,20 399w	872,40 448w	901,40 497w	957,70 595w	1012,60 692w	1076,60 790w	1106,90 887w	1137,50 985w	1171,30 1082w
CKLV 45	€	992,40 325w	1039,30 391w	1080,50 457w	1121,50 523w	1166,80 588w	1206,80 654w	1295,50 786w	1376,90 918w	1470,00 1050w	1516,20 1181w	1562,00 1313w	1609,90 1445w
CKV 54	€	800,60 304w	832,10 362w	863,70 420w	895,80 478w	927,20 537w	958,90 595w	1023,40 712w	1087,10 828w	1161,40 945w	1197,10 1061w	1233,00 1178w	1268,40 1294w
CKLV 54	€	1025,30 399w	1071,90 480w	1116,90 562w	1163,70 643w	1210,40 724w	1256,20 805w	1348,90 967w	1438,10 1129w	1531,80 1291w	1581,50 1453w	1631,20 1616w	1681,40 1778w
CKV 63	€	848,70 352w	884,70 420w	918,50 488w	954,00 555w	991,50 623w	1027,40 691w	1099,60 827w	1169,40 962w	1247,10 1098w	1285,80 1233w	1324,50 1369w	1362,20 1504w
CKLV 63	€	1115,10 472w	1172,60 568w	1224,90 664w	1278,60 761w	1335,70 857w	1386,90 953w	1497,90 1146w	1604,40 1338w	1720,10 1531w	1777,00 1723w	1833,60 1916w	1890,60 2109w
CKV 72	€	894,20 403w	936,70 480w	978,10 557w	1018,40 635w	1060,20 712w	1099,90 789w	1182,60 944w	1258,80 1098w	1341,10 1253w	1382,60 1407w	1424,00 1562w	1463,80 1716w
CKLV 72	€	1165,50 546w	1227,30 658w	1285,50 769w	1344,30 881w	1402,80 992w	1464,60 1104w	1584,00 1327w	1698,10 1550w	1817,00 1773w	1877,20 1996w	1937,30 2219w	1996,50 2441w
CKV 81	€	975,00 453w	1018,50 540w	1064,80 627w	1107,10 714w	1154,40 800w	1195,70 887w	1287,90 1061w	1369,40 1234w	1461,30 1408w	1506,00 1581w	1550,70 1755w	1595,40 1928w
CKLV 81	€	1246,40 621w	1309,20 747w	1372,10 874w	1435,10 1001w	1499,30 1128w	1562,30 1254w	1689,60 1508w	1809,60 1761w	1940,80 2014w	2004,20 2268w	2068,10 2521w	2130,30 2774w
CKV 90	€	1041,40 504w	1088,90 600w	1133,60 696w	1180,70 793w	1227,80 889w	1272,60 985w	1365,50 1178w	1453,10 1370w	1551,70 1563w	1598,60 1755w	1646,00 1948w	1693,10 2141w
CKLV 90	€	1316,20 695w	1384,00 837w	1449,50 979w	1514,80 1121w	1580,10 1263w	1647,00 1405w	1777,40 1688w	1903,30 1972w	2038,60 2256w	2103,90 2540w	2169,70 2824w	2236,20 3107w

$\Delta t$  diversi da 50K: consultare Dati tecnici Brem

## ORDINE

Indicare: modello se semplice o con tubi,  
 altezza e larghezza in cm; attacco e colore  
 es.: CKLV 72-180, EG  $\varnothing$ 3/8", SB 7035

## ESECUZIONI DI SERIE

Colore bianco sablé SB9016- Mensole EOS  
 Tolleranze  $\pm$  3mm - Valvola di sfianto  $\varnothing$  1/8"  
 PRESSIONE MASSIMA D'ESERCIZIO 4 BAR

## ESECUZIONI A RICHIESTA

Verniciatura tabella colori Brem +15/25%  
 Finitura acciaio INOX a preventivo  
 Versione elettrica e.Clak pag.216

## ATTACCHI DI SERIE

EG  $\varnothing$ 3/8"  
 A richiesta  $\varnothing$  1/2" con manicotti  
 Attacchi speciali, pag.278



INTERASSE ATTACCHI EG 3/8" verticali

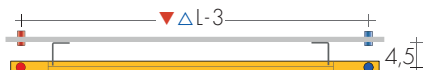

MODELLO CKV



MODELLO CKLV

A richiesta attacchi laterali 3/8" ▲▼ H-4cm  
Supplemento Art. AS 81,40€



Attacchi ø 3/8"  
DI SERIE  
(a filo piastra)



Attacchi ø 1/2"  
A RICHIESTA  
(con manicotti)

FISSAGGI  
Mensole comprese



Mensola  
EOS



VALVOLE CONSIGLIATE

KIT VALVOLE CROMATE comprende:

- n°2 Valvole con codoli
- n°2 Raccordi (per multistrato ø16 e rame ø12 e 14)
- n°2 Rosette tonde cromo ø 48, foro ø16

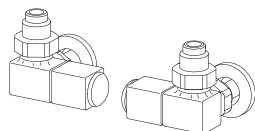

KIT VALVOLE QUADRA comando LATERALE  
pag. 271 Art. KQL 177,10€  
Colore tabella BREM supplemento 49,50€

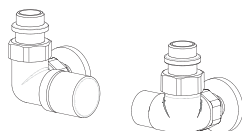

KIT VALVOLE CYL termostattabile con comando  
LATERALE, pag.273 Art. KCL 150,50€  
Colore tabella BREM supplemento 49,50€

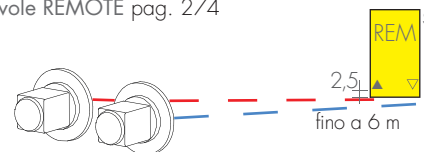

ATTACCHI REMOTI Art. REM 37,60€  
Interasse attacchi sul retro: ▲▼L - 5 cm  
KIT Raccordi NICKEL spazz. suppl.Art. RN 28,20€  
Valvole REMOTE pag. 274

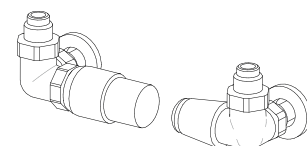

KIT VALVOLE TON comando LATERALE con testa  
TERMOSTATICA, pag. 269 Art. KTL 188,60€



CLAK CKV 45-160

Basso, molto basso, gradevole, con un fronte piatto che ne annulla la presenza, pratico

per gli impieghi più vari. La grande potenza convettiva di questo modello è ottenuta grazie

all'applicazione di lamelle che aumentano considerevolmente le rese caloriche.

## MODELLO C... ..

H = 7 - 14 - 21 - 28 cm  
L = da 50 a 600 cm

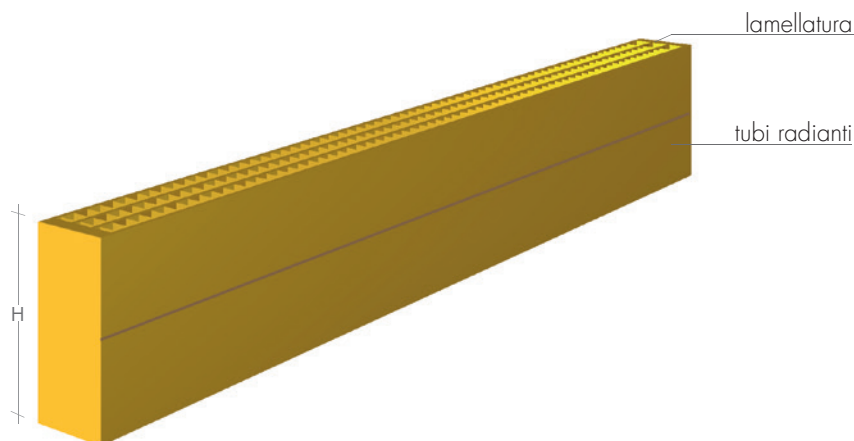

## MODELLO C... ..

fronte e retro in tubi radianti



C..- 2

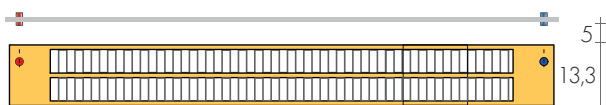

C..- 3

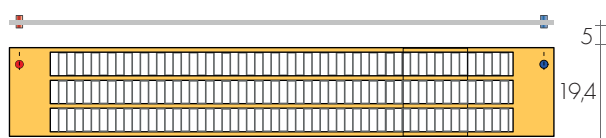

C..- 4

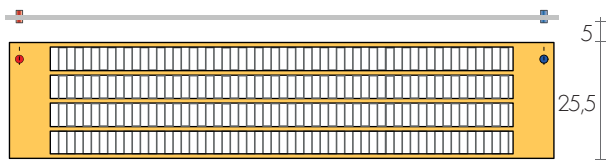

C..- 5

## MODELLO C... .. /L

con lamelle sul retro

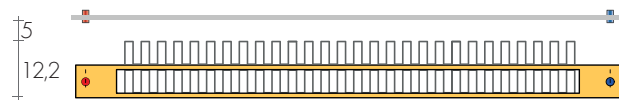

C..- 2/L



C..- 3/L

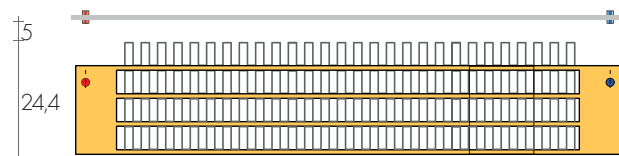

C..- 4/L

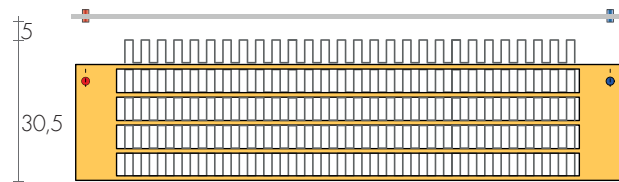

C..- 5/L

## ORDINE

Indicare: il modello (L con lamelle sul retro), l'altezza in cm, il numero dei tubi radianti e la lunghezza in cm; l'allacciamento e il colore es.: C14-3L 360 AC ø 1/2" RAL 7015

## ESECUZIONI DI SERIE

Colore bianco brillante RAL 9016, sfciato ø1/2"  
Mensole e piedini non compresi.  
Pressione massima d'esercizio 6 BAR

## ESECUZIONI A RICHIESTA

Verniciatura tabella colori Brem fino a 3 mt o 100 Kg. (oltre richiedere fattibilità) e tutti i colori della scala RAL CLASSIC +30%

## ATTACCHI DI SERIE

EG ø 1/2"  
A richiesta attacchi AC o BD e speciali, pag. 278



## INTERASSE ALLACCIAMENTI

Di serie attacchi EG verticali  
A richiesta attacchi laterali, senza supplemento

Modelli con tubi sul retro

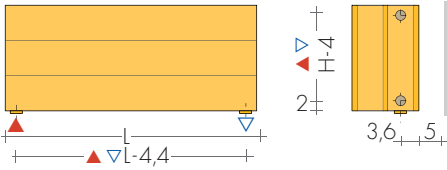

Modelli con lamelle sul retro

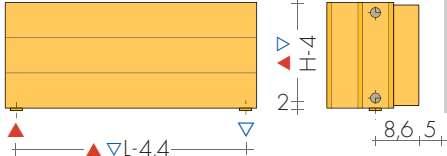

Modelli C7 (h 7 cm)

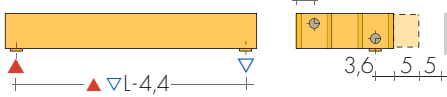

Attacchi sfalsati sullo stesso lato per i modelli:  
C7-3, C7-3/L, C7-4, C7-4/L, C7-5, C7-5/L

Sporgenza manicotti: 3 mm per  $\varnothing 1/2''$   
17mm per  $\varnothing 3/4''$



## FISSAGGI C-PROLUX

Nei caloriferi C-Prolux le mensole e i piedini, dotati di supporti insonorizzanti in plastica, non sono compresi nell'imballo. Il numero delle mensole e dei piedini varia secondo gli schemi riportati.

Posizioni dei piedini o delle mensole per il montaggio dei C-Prolux

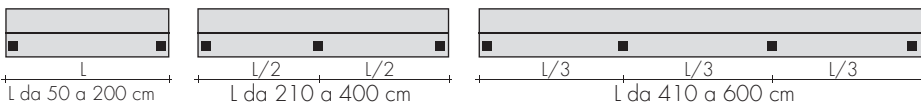

## FISSAGGI A PARETE

Le mensole dei convettori sono fornite a richiesta:

Zincata Art. 142 44,90€  
Bianca Art. 142W 60,30€

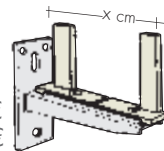

## PIEDINI

Piedini regolabili con supporti insonorizzanti:

Zincato Art. 150 53,80€  
Bianco Art. 150W 76,10€

H = 9/12 cm (di serie)

A richiesta  
H = 6,5/9 cm  
H = 12/18 cm  
H = 18/27 cm  
H = 27/37 cm

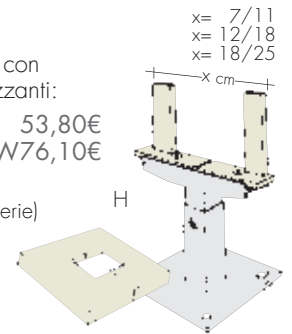

Copertura della base del piedino 80x80x4mm) in plastica di colore bianco Art. 156 14,0€

## VALVOLE CONSIGLIATE

KIT VALVOLE CROMATE comprende:

- n°2 Valvole con codoli
- n°2 Raccordi (per multistrato  $\varnothing 16$  e rame  $\varnothing 12$  e 14)
- n°2 Rosette tonde cromo  $\varnothing 48$ , foro  $\varnothing 16$

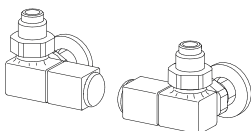

KIT VALVOLE QUADRA comando LATERALE  
pag. 271 Art. KQL 177,10€  
Colore tabella BREM supplemento 49,50€

## FINITURE SPECIALI

pag. 267

Finiture Oro, Bronzo, Nickel spazzolato per 2 valvole

KIT Raccordi NICKEL spazz. suppl. Art. RN 28,20€

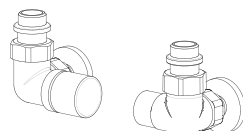

KIT VALVOLE CYL termostattizzabile con comando LATERALE, pag. 273 Art. KCL 150,50€  
Colore tabella BREM supplemento 49,50€

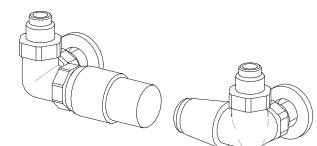

KIT VALVOLE TON comando LATERALE con testa TERMOSTATICA, pag. 269 Art. KTL 188,60€

MOD.	Lcm	50	60	70	80	90	100	110	120	130	140	150	160	170	180	190	200
C7-2	€ 320,50	333,00	345,20	357,60	370,00	382,40	394,60	407,10	419,30	431,60	443,80	456,30	468,70	481,10	493,40	505,60	
	174w	209w	244w	279w	314w	349w	384w	419w	454w	489w	524w	558w	593w	628w	663w	698w	
C7-2/L	€ 386,50	403,80	420,80	437,90	454,70	471,80	488,90	506,00	523,10	540,10	557,10	574,10	591,40	608,50	625,50	642,60	
	202w	243w	284w	324w	365w	405w	446w	486w	527w	567w	608w	648w	689w	729w	770w	810w	
C7-3	€ 436,60	456,40	476,40	496,40	516,30	536,20	556,30	576,30	596,30	616,00	636,10	656,00	676,00	695,80	715,90	735,80	
	296w	356w	415w	474w	534w	593w	652w	712w	771w	830w	890w	949w	1008w	1067w	1127w	1186w	
C7-3/L	€ 500,90	523,70	546,60	569,40	592,30	615,30	638,10	660,80	683,80	706,70	729,40	752,30	775,20	798,00	820,80	843,90	
	321w	385w	449w	514w	578w	642w	706w	770w	835w	899w	963w	1027w	1091w	1156w	1220w	1284w	
C7-4	€ 553,80	583,80	613,60	643,80	673,60	703,50	733,40	763,40	793,40	823,30	853,20	883,20	913,10	943,10	973,00	1002,9	
	406w	488w	569w	650w	732w	813w	894w	976w	1057w	1138w	1220w	1301w	1382w	1463w	1545w	1626w	
C7-4/L	€ 606,50	639,20	672,00	704,40	737,30	769,90	802,50	835,40	867,80	900,70	933,10	966,00	998,70	1031,2	1064,0	1096,4	
	468w	562w	656w	750w	843w	937w	1031w	1124w	1218w	1312w	1406w	1499w	1593w	1687w	1780w	1874w	
C7-5	€ 670,80	708,40	746,30	784,10	821,90	859,40	897,30	935,10	972,90	1010,4	1048,3	1086,1	1123,9	1161,5	1199,4	1237,1	
	512w	615w	718w	820w	922w	1025w	1128w	1230w	1332w	1435w	1538w	1640w	1743w	1845w	1948w	2050w	
C7-5/L	€ 811,10	858,30	905,60	953,00	1000,3	1047,5	1094,8	1142,0	1189,4	1236,6	1283,9	1331,2	1378,3	1425,7	1472,9	1520,3	
	582w	698w	814w	930w	1047w	1163w	1279w	1396w	1512w	1628w	1745w	1861w	1977w	2093w	2210w	2326w	
C14-2	€ 438,60	460,30	482,10	504,00	525,60	547,40	569,20	590,90	612,80	634,40	656,30	678,10	699,70	721,60	743,50	765,20	
	272w	326w	380w	434w	489w	543w	597w	652w	706w	760w	814w	869w	923w	977w	1032w	1086w	
C14-2/L	€ 539,60	575,10	610,90	646,40	681,90	717,50	753,00	788,70	824,00	859,70	895,30	930,70	966,50	1001,9	1037,7	1073,1	
	364w	436w	509w	582w	654w	727w	800w	872w	945w	1018w	1091w	1163w	1236w	1309w	1381w	1454w	
C14-3	€ 600,50	642,70	684,80	727,00	768,90	810,90	853,10	895,20	937,20	979,40	1021,4	1063,7	1105,5	1147,8	1189,8	1231,9	
	439w	527w	615w	702w	790w	878w	966w	1054w	1141w	1229w	1317w	1405w	1493w	1580w	1668w	1756w	
C14-3/L	€ 668,20	713,90	759,70	805,60	850,90	896,80	942,50	988,40	1033,9	1079,7	1125,4	1171,2	1217,0	1262,5	1308,3	1354,1	
	538w	646w	754w	862w	969w	1077w	1185w	1292w	1400w	1508w	1616w	1723w	1831w	1939w	2046w	2154w	
C14-4	€ 772,50	831,50	890,20	948,90	1007,8	1066,6	1125,3	1184,2	1243,0	1301,7	1360,6	1419,4	1478,1	1537,0	1595,8	1654,6	
	592w	711w	830w	948w	1067w	1185w	1304w	1422w	1541w	1659w	1778w	1896w	2015w	2133w	2252w	2370w	
C14-4/L	€ 824,00	884,70	945,20	1005,9	1066,6	1127,1	1187,6	1248,6	1309,0	1369,5	1430,3	1490,9	1551,4	1611,9	1672,7	1733,2	
	701w	841w	981w	1122w	1262w	1402w	1542w	1682w	1823w	1963w	2103w	2243w	2383w	2524w	2664w	2804w	
C14-5	€ 966,30	1045,5	1124,6	1203,5	1282,9	1362,0	1441,0	1520,1	1599,3	1678,3	1757,4	1836,5	1915,6	1994,7	2073,8	2153,0	
	743w	892w	1040w	1189w	1337w	1486w	1635w	1783w	1932w	2080w	2229w	2378w	2526w	2675w	2823w	2972w	
C14-5/L	€ 1202,0	1305,6	1408,8	1512,1	1615,4	1718,6	1822,0	1925,3	2028,4	2131,7	2235,1	2338,4	2441,7	2544,9	2648,3	2751,5	
	847w	1016w	1185w	1354w	1524w	1693w	1862w	2032w	2201w	2370w	2540w	2709w	2878w	3047w	3217w	3386w	
C21-2	€ 542,20	570,50	598,70	627,10	655,30	683,80	711,90	740,50	768,50	796,80	825,20	853,40	882,00	910,10	938,60	966,70	
	346w	415w	484w	553w	622w	691w	760w	829w	898w	967w	1036w	1106w	1175w	1244w	1313w	1382w	
C21-2/L	€ 623,60	663,50	703,80	744,10	784,60	824,80	864,80	905,10	945,50	986,00	1026,2	1066,5	1106,6	1146,8	1187,1	1227,5	
	488w	586w	684w	782w	879w	977w	1075w	1172w	1270w	1368w	1466w	1563w	1661w	1759w	1856w	1954w	
C21-3	€ 684,50	732,80	781,10	829,30	877,70	926,00	974,20	1022,3	1070,6	1118,9	1167,3	1215,4	1263,8	1312,0	1360,2	1408,7	
	564w	676w	789w	902w	1014w	1127w	1240w	1352w	1465w	1578w	1690w	1803w	1916w	2029w	2141w	2254w	
C21-3/L	€ 763,40	817,50	871,60	925,70	979,80	1033,7	1087,6	1141,8	1196,0	1250,0	1304,0	1358,2	1412,5	1466,4	1520,5	1574,6	
	708w	849w	991w	1132w	1274w	1415w	1557w	1698w	1840w	1981w	2122w	2264w	2406w	2547w	2688w	2830w	
C21-4	€ 904,20	974,30	1044,6	1114,8	1185,0	1255,2	1325,5	1395,8	1465,9	1536,2	1606,3	1676,6	1746,7	1817,0	1887,4	1957,6	
	820w	984w	1148w	1312w	1476w	1640w	1804w	1968w	2132w	2296w	2460w	2624w	2788w	2952w	3116w	3280w	
C21-4/L	€ 976,60	1052,1	1127,6	1203,0	1278,5	1353,9	1429,5	1504,9	1580,4	1655,9	1731,2	1806,9	1882,3	1957,7	2033,3	2108,5	
	904w	1085w	1266w	1446w	1627w	1808w	1989w	2170w	2350w	2531w	2712w	2893w	3074w	3254w	3435w	3616w	
C21-5	€ 1127,3	1221,0	1314,7	1408,3	1501,9	1595,5	1689,1	1782,8	1876,5	1970,1	2063,9	2157,2	2251,0	2344,7	2438,4	2531,9	
	1046w	1255w	1464w	1674w	1883w	2092w	2301w	2510w	2720w	2929w	3138w	3347w	3556w	3766w	3975w	4184w	
C21-5/L	€ 1498,6	1614,2	1730,0	1845,8	1961,5	2077,2	2193,0	2308,5	2424,5	2540,1	2655,9	2771,6	2887,4	3003,3	3118,7	3234,5	
	1102w	1322w	1542w	1762w	1983w	2203w	2423w	2644w	2864w	3084w	3305w	3525w	3745w	3965w	4186w	4406w	
C28-2	€ 653,00	689,50	725,60	762,20	798,30	834,80	870,90	907,20	943,50	979,90	1016,1	1052,3	1089,0	1124,9	1161,4	1197,6	
	404w	485w	566w	647w	728w	809w	890w	971w	1052w	1133w	1214w	1294w	1375w	1456w	1537w	1618w	
C28-2/L	€ 741,40	793,40	845,10	897,20	949,00	1001,1	1052,7	1104,6	1156,6	1208,4	1260,3	1312,2	1364,0	1416,0	1467,8	1519,9	
	577w	692w	808w	923w	1039w	1154w	1269w	1385w	1500w	1616w	1731w	1846w	1962w	2077w	2193w	2308w	
C28-3	€ 808,50	870,90	933,20	995,70	1058,1	1120,7	1183,1	1245,5	1308,0	1370,1	1432,6	1495,0	1557,5	1619,9	1682,4	1744,9	
	682w	818w	954w	1090w	1227w	1363w	1499w	1636w	1772w	1908w	2044w	2181w	2317w	2453w	2590w	2726w	
C28-3/L	€ 894,30	964,10	1033,6	1103,3	1173,0	1242,8	1312,3	1382,1	1451,6	1521,3	1591,2	1660,6	1730,4	1800,1	1869,8	1939,5	
	840w	1008w	1176w	1344w	1512w	1680w	1848w	2016w	2184w	2352w	2520w	2688w	2856w	3024w	3192w	3360w	
C28-4	€ 1079,2	1169,7	1259,9	1350,2	1440,7	1531,1	1621,4	1711,7	1802,1	1892,6	1982,9	2073,1	2163,7	2254,0	2344,8	2434,8	
	942w	1130w	1319w	1507w	1696w	1884w	2072w	2261w	2449w	2638w	2826w	3014w	3203w	3391w	3580w	3768w	
C28-4/L	€ 1161,6	1258,5	1355,4	1452,5	1549,3	1646,2	1743,1	1840,0	1936,9	2034,1	2130,8	2227,9	2324,6	2421,6	2518,5	2615,4	
	1097w	1316w	1536w	1755w	1975w	2194w	2413w	2633w	2852w	3072w	3291w	3510w					

EN 442 Watt Δt 50K (Δt 40K = Wx0,75) - (Δt 30K = Wx0,526)

220	240	260	280	300	*320	*340	*360	*380	*400	*420	*440	*460	*480	*500	*600
530,40	555,10	579,70	604,60	629,30	653,80	678,50	703,30	727,90	752,60	777,30	801,90	826,70	851,30	876,00	999,30
768w	838w	907w	977w	1047w	1117w	1187w	1256w	1326w	1396w	1466w	1536w	1605w	1675w	1745w	2094w
676,80	710,90	745,10	779,20	813,30	847,60	881,60	915,80	949,90	984,00	1018,2	1052,3	1086,5	1120,8	1154,9	1325,5
891w	972w	1053w	1134w	1215w	1296w	1377w	1458w	1539w	1620w	1701w	1782w	1863w	1944w	2025w	2430w
775,70	815,50	855,40	895,40	935,20	975,10	1015,0	1054,8	1094,8	1134,7	1174,5	1214,5	1254,4	1294,3	1334,1	1533,7
1305w	1423w	1542w	1660w	1779w	1898w	2016w	2135w	2253w	2372w	2491w	2609w	2728w	2846w	2965w	3558w
889,40	935,20	980,70	1026,6	1072,4	1118,0	1163,8	1209,4	1255,2	1300,8	1346,6	1392,3	1438,0	1483,8	1529,4	1758,0
1412w	1541w	1669w	1798w	1926w	2054w	2183w	2311w	2440w	2568w	2696w	2825w	2953w	3082w	3210w	3852w
1062,6	1122,7	1182,5	1242,4	1302,3	1362,1	1422,1	1482,0	1541,8	1601,7	1661,4	1721,3	1781,2	1841,1	1901,1	2200,2
1789w	1951w	2114w	2276w	2439w	2602w	2764w	2927w	3089w	3252w	3415w	3577w	3740w	3902w	4065w	4878w
1161,7	1227,1	1292,6	1358,0	1423,2	1488,5	1553,8	1619,3	1684,6	1749,8	1815,0	1880,3	1945,7	2011,0	2076,4	2403,0
2061w	2249w	2436w	2624w	2811w	2998w	3186w	3373w	3561w	3748w	3935w	4123w	4310w	4498w	4685w	5622w
1312,6	1388,1	1463,6	1539,2	1614,6	1690,2	1765,7	1841,2	1916,9	1992,3	2067,9	2143,2	2218,9	2294,3	2369,9	2747,3
2255w	2423w	2600w	2777w	2954w	3131w	3308w	3485w	3662w	3839w	4016w	4193w	4370w	4547w	4724w	5615w
1614,6	1709,1	1803,8	1898,4	1993,0	2087,5	2182,0	2276,5	2371,0	2465,7	2560,4	2654,8	2749,3	2843,9	2938,4	3411,2
2559w	2791w	3024w	3256w	3489w	3722w	3954w	4187w	4419w	4652w	4885w	5117w	5350w	5582w	5815w	6978w
808,90	852,30	895,90	939,30	983,00	1026,5	1070,0	1113,5	1157,1	1200,6	1244,3	1287,9	1331,4	1374,9	1418,4	1636,3
1195w	1303w	1412w	1520w	1629w	1738w	1846w	1955w	2063w	2172w	2281w	2389w	2498w	2606w	2715w	3258w
1144,1	1215,4	1286,5	1357,5	1428,7	1499,9	1571,0	1642,2	1713,3	1784,5	1855,6	1926,9	1997,5	2068,9	2140,0	2495,7
1599w	1745w	1890w	2036w	2181w	2326w	2472w	2617w	2763w	2908w	3053w	3199w	3344w	3490w	3635w	4362w
1316,1	1400,4	1484,3	1568,6	1652,8	1736,9	1821,0	1905,2	1989,4	2073,5	2157,6	2241,9	2326,3	2410,3	2494,6	2915,2
1932w	2107w	2283w	2458w	2634w	2810w	2985w	3161w	3336w	3512w	3688w	3863w	4039w	4214w	4390w	5268w
1445,4	1536,9	1628,3	1719,7	1811,3	1902,5	1994,0	2085,5	2176,8	2268,2	2359,8	2451,2	2542,8	2634,1	2725,5	3182,8
2369w	2585w	2800w	3016w	3231w	3446w	3662w	3877w	4093w	4308w	4523w	4739w	4954w	5170w	5385w	6462w
1772,0	1889,9	2007,5	2125,0	2242,6	2360,3	2477,9	2595,5	2713,0	2830,9	2948,2	3066,0	3183,5	3301,1	3418,8	4006,7
2607w	2844w	3081w	3318w	3555w	3792w	4029w	4266w	4503w	4740w	4977w	5214w	5451w	5688w	5925w	7110w
1854,5	1975,6	2096,9	2218,2	2339,3	2460,7	2581,6	2703,0	2824,2	2945,4	3066,5	3187,8	3308,9	3430,4	3551,4	4157,6
3084w	3365w	3645w	3926w	4206w	4486w	4767w	5047w	5328w	5608w	5888w	6169w	6449w	6730w	7010w	8412w
2311,1	2469,5	2627,4	2785,9	2944,0	3102,3	3260,3	3418,7	3576,8	3735,1	3893,2	4051,6	4209,7	4367,8	4526,0	5317,2
3269w	3566w	3864w	4161w	4458w	4755w	5052w	5350w	5647w	5944w	6241w	6538w	6836w	7133w	7430w	8916w
2958,1	3164,7	3371,3	3577,9	3784,4	3991,1	4197,6	4404,1	4611,0	4817,3	5024,0	5230,7	5437,1	5643,9	5850,4	7045,2
3725w	4063w	4402w	4740w	5079w	5418w	5756w	6095w	6433w	6772w	7111w	7449w	7788w	8126w	8465w	10152w
1023,3	1080,2	1136,8	1193,2	1249,9	1306,5	1363,1	1419,8	1476,4	1533,0	1589,7	1646,3	1702,9	1759,6	1816,3	2099,5
1520w	1658w	1797w	1935w	2073w	2211w	2349w	2488w	2626w	2764w	2902w	3040w	3179w	3317w	3455w	4146w
1308,1	1388,5	1469,2	1549,7	1630,2	1710,9	1791,2	1871,7	1952,6	2033,1	2113,4	2194,2	2274,8	2355,3	2435,8	2838,5
2149w	2345w	2540w	2736w	2931w	3126w	3322w	3517w	3713w	3908w	4103w	4299w	4494w	4690w	4885w	5862w
1505,1	1601,7	1698,0	1794,6	1891,1	1987,7	2084,1	2180,9	2277,1	2373,7	2470,2	2566,8	2663,4	2759,8	2856,6	3339,0
2479w	2705w	2930w	3156w	3381w	3606w	3832w	4057w	4283w	4508w	4733w	4959w	5184w	5410w	5635w	6762w
1682,7	1790,8	1899,0	2007,2	2115,5	2223,7	2331,8	2440,0	2548,0	2656,3	2764,4	2872,7	2980,6	3088,9	3197,1	3738,1
3113w	3396w	3679w	3962w	4245w	4528w	4811w	5094w	5377w	5660w	5943w	6226w	6509w	6792w	7075w	8490w
2098,0	2238,5	2378,9	2519,1	2659,8	2800,2	2940,7	3081,0	3221,6	3362,2	3502,5	3642,9	3783,6	3924,1	4064,4	4879,2
3608w	3936w	4264w	4592w	4920w	5248w	5576w	5904w	6232w	6560w	6888w	7216w	7544w	7872w	8200w	9890w
2259,6	2410,4	2561,5	2712,4	2863,2	3014,2	3165,1	3316,1	3467,0	3617,9	3768,9	3919,8	4070,9	4221,8	4372,7	5263,2
3978w	4339w	4701w	5062w	5424w	5786w	6147w	6509w	6870w	7232w	7594w	7955w	8317w	8678w	9040w	10890w
2719,2	2906,5	3093,7	3280,9	3468,2	3655,6	3842,8	4030,1	4217,3	4404,6	4592,0	4779,1	4966,2	5153,3	5340,4	6415,2
4602w	5021w	5439w	5858w	6276w	6694w	7113w	7531w	7950w	8368w	8786w	9205w	9623w	10042w	10460w	12580w
3466,1	3697,5	3928,9	4160,4	4391,9	4623,4	4854,8	5086,3	5317,7	5549,2	5780,6	6012,1	6243,5	6475,0	6706,4	8076,8
4847w	5287w	5728w	6168w	6609w	7050w	7490w	7931w	8371w	8812w	9252w	9693w	10133w	10574w	11014w	13280w
1270,3	1342,8	1415,4	1488,2	1560,7	1633,3	1705,8	1778,7	1850,9	1923,6	1996,4	2068,9	2141,5	2214,0	2286,7	2649,9
1780w	1942w	2103w	2265w	2427w	2589w	2751w	2912w	3074w	3236w	3398w	3560w	3721w	3883w	4045w	4854w
1623,6	1727,5	1831,2	1934,7	2038,8	2142,4	2246,5	2350,0	2453,7	2557,7	2661,4	2765,3	2868,9	2972,7	3076,7	3595,6
2539w	2770w	3000w	3231w	3462w	3693w	3924w	4154w	4385w	4616w	4847w	5078w	5308w	5539w	5770w	6924w
1869,8	1994,5	2119,4	2244,3	2369,1	2493,8	2618,7	2743,5	2868,5	2993,2	3118,1	3243,0	3368,0	3492,8	3617,6	4241,8
2999w	3271w	3544w	3816w	4089w	4362w	4634w	4907w	5179w	5452w	5725w	5997w	6270w	6542w	6815w	8178w
2078,7	2218,2	2357,6	2496,6	2636,0	2775,6	2914,8	3054,1	3193,6	3332,9	3472,0	3611,5	3751,0	3890,3	4029,6	4848,0
3696w	4032w	4368w	4704w	5040w	5376w	5712w	6048w	6384w	6720w	7056w	7392w	7728w	8064w	8400w	10080w
2615,4	2796,3	2976,9	3157,5	3338,4	3519,2	3699,7	3880,7	4061,3	4242,0	4422,8	4603,6	4784,4	4965,2	5146,0	6180,0
4145w	4522w	4898w	5275w	5652w	6029w	6406w	6782w	7159w	7536w	7913w	8290w	8667w	9044w	9420w	11280w
2809,4	3003,3	3196,8	3390,7	3584,6	3778,5	3972,2	4166,1	4359,9	4553,8	4747,7	4941,6	5135,5	5329,4	5523,3	6648,0
4827w	5266w	5704w	6143w	6582w	7021w	7460w	7900w	8339w	8778w	9217w	9656w	10095w	10534w	10973w	13160w
3422,6	3665,8	3908,9	4152,1	4395,1	4638,4	4881,7	5125,0	5368,3	5611,6	5854,9	6098,2	6341,5	6584,8	6828,1	8208,0
5269w	5748w	6227w	6706w	7185w	7664w	8143w	8622w	9101w	9580w	10059w	10538w	11017w	11496w	11975w	14360w

4215,8  
5608w

Lunghezze ogni 20 cm tra 5 e 6 m: interpolare rese e prezzi

\*Modelli con lunghezze oltre 3 metri,  
TRASPORTI E IMBALLI A PREVENTIVO  
o ritirati direttamente in fabbrica.

Δt diversi da 50 K: consultare Dati tecnici Brem

7,2 C...-2

13,3 C...-3

19,4 C...-4

25,5 C...-5

12,2 C...-2/L

18,3 C...-3/L

24,4 C...-4/L

30,5 C...-5/L

La piastra EGON è costituita da tubi piatti curvati che inducono un andamento ondu-

lato con un grande effetto di armonia e morbidezza.

La piastra Egon può essere utilizzata sia in verticale che in orizzontale.

## MODELLO EH

con tubi piatti verticali

L = da 1 a 15 el. (ogni 7,7 cm)

H = da 60 a 300 cm

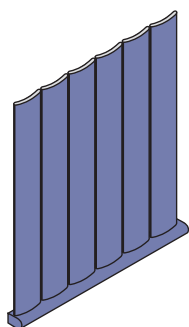

EH

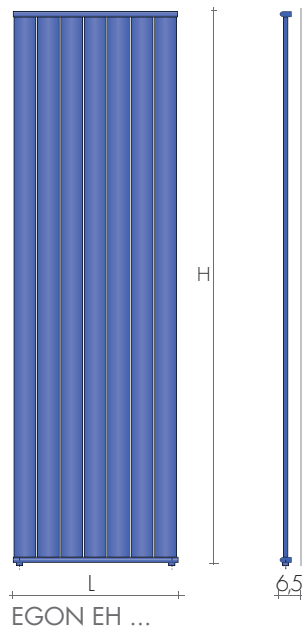

EGON EH ...

## MODELLO EV

con tubi piatti orizzontali

L = da 60 a 300 cm

H = da 1 a 15 el.

(ogni 7,65 cm)

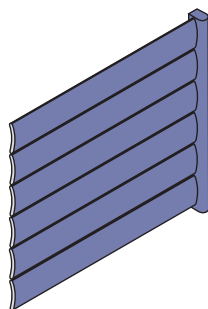

EV

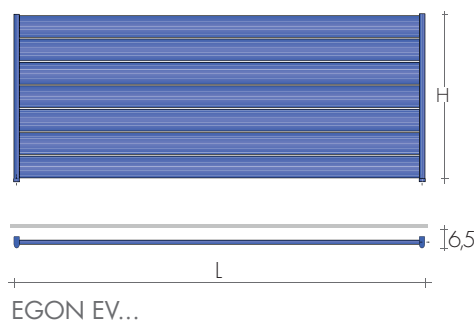

EGON EV...

## ORDINE

Indicare: il modello con l'altezza in cm e il numero degli elementi; l'attacco e il colore.  
Es. EH 180 - 5 el - EG ø 1/2" - SB 9010

## ESECUZIONI DI SERIE

Colore bianco sablé SB9016- Mensole EOS  
Valvola di sfiato ø 1/8" - Tolleranze ± 3mm  
Pressione massima d'esercizio 4 BAR

## ESECUZIONI A RICHIESTA

Verniciatura tabella colori Brem fino a 3 mt  
(oltre richiedere fattibilità) +15/25%  
Piedini e fissaggi, pag. 276

## ATTACCHI DI SERIE

EG ø 1/2"  
A richiesta attacchi AC o BD  
Attacchi speciali, pag. 278

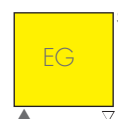

**INTERASSE ATTACCHI**

Di serie attacchi EG verticali  
A richiesta attacchi laterali, senza supplemento  
**MODELLO EH**

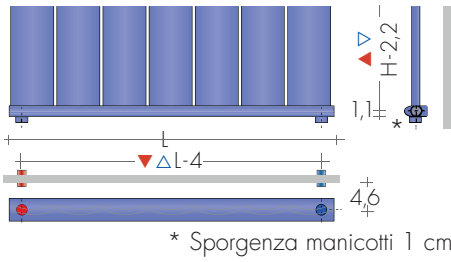

**MODELLO EV**

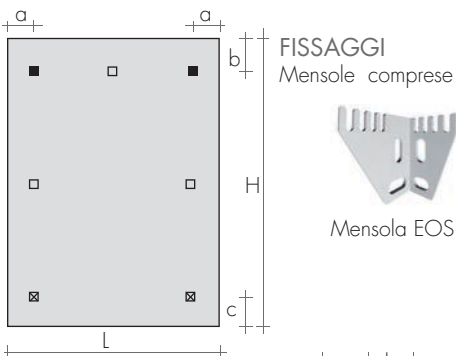
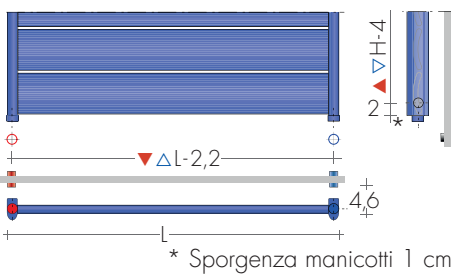

Mod.	a cm	b cm	c cm
EH	8	8	8
EV	8	9	7

□ da H o L 220 cm  
⊗ per attacchi speciali

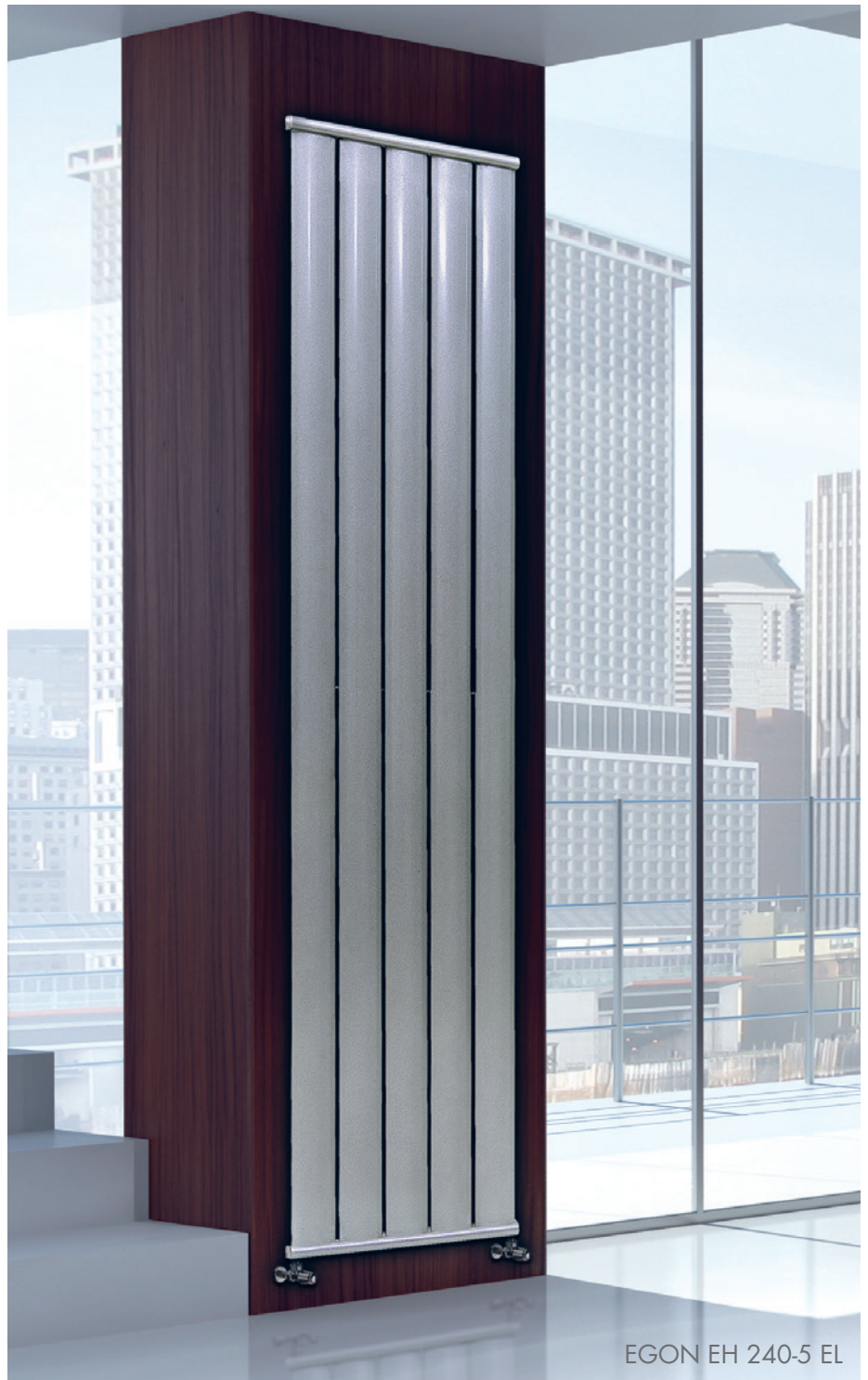

PIASTRE

**VALVOLE CONSIGLIATE**

KIT VALVOLE CROMATE comprende:

- n°2 Valvole con codoli
- n°2 Raccordi (per multistrato ø16 e rame ø12 e 14)
- n°2 Rosette tonde cromo ø 48, foro ø16

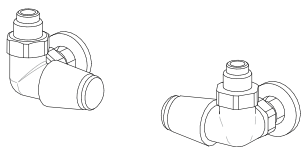

KIT VALVOLE TON comando LATERALE  
pag.269 Art. KVL 139,20€

**FINITURE SPECIALI**

pag. 267  
Finiture Oro, Bronzo, Nickel spazzolato per 2 valvole  
KIT Raccordi NICKEL spazz. suppl.Art. RN 28,20€

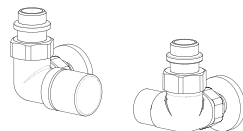

KIT VALVOLE CYL termostattizzabile con comando LATERALE, pag.273 Art. KCL 150,50€  
Colore tabella BREM supplemento 49,50€

**ATTACCHI REMOTI**

Art. REM 37,60€  
Interasse attacchi sul retro: ▲▽L - 5 cm  
Valvole REMOTE pag. 274

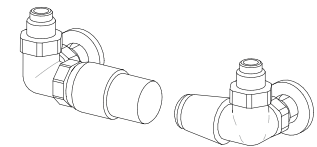
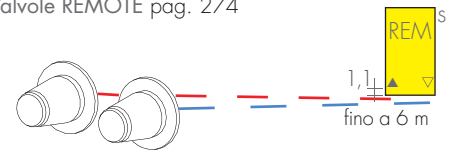

KIT VALVOLE TON comando LATERALE con testa TERMOSTATICA, pag. 269 Art. KTL 188,60€

MOD.	(n°el)	EN 442 Watt Δt 50K (Δt 40K = Wx0,755) - (Δt 30K = Wx0,526)														
		1 el	2 el	3 el	4 el	5 el	6 el	7 el	8 el	9 el	10 el	11 el	12 el	13 el	14 el	15 el
L cm	▲▼	8,0	15,7	23,5	31,2	39,0	46,7	54,5	62,2	70,0	77,7	85,5	93,3	101,0	108,8	116,5
H cm	▲▼	4,0	11,7	19,5	27,2	35,0	42,7	50,5	58,2	66,0	73,7	81,5	89,3	97,0	104,8	112,5
EH 60	€	146,70 51w	185,00 102w	223,90 153w	261,50 204w	300,10 255w	338,70 306w	375,00 357w	413,90 408w	452,60 459w	489,60 510w	528,80 561w	565,40 612w	604,60 663w	642,30 714w	679,50 765w
EH 80	€	168,80 68w	212,80 136w	258,10 204w	302,20 272w	346,30 340w	390,70 408w	434,90 476w	478,50 544w	524,20 612w	568,30 680w	611,10 748w	655,30 816w	699,30 884w	743,80 952w	788,80 1020w
EH 100	€	182,00 83w	230,30 166w	280,40 249w	328,50 332w	377,10 415w	427,10 498w	476,60 581w	526,40 664w	575,10 747w	623,60 830w	672,90 913w	721,50 996w	771,10 1079w	819,60 1162w	869,40 1245w
EH 120	€	199,80 97w	250,40 194w	302,20 291w	352,90 388w	406,00 485w	456,40 582w	508,50 679w	559,30 776w	611,10 873w	663,10 970w	714,60 1067w	765,70 1164w	817,20 1261w	869,40 1358w	921,10 1455w
EH 140	€	208,30 112w	263,80 224w	320,10 336w	374,10 448w	430,00 560w	485,50 672w	539,60 784w	595,70 896w	650,60 1008w	707,00 1120w	761,00 1232w	816,30 1344w	872,40 1456w	926,50 1568w	982,10 1680w
EH 160	€	223,90 127w	286,90 254w	350,70 381w	414,60 508w	478,50 635w	542,60 762w	606,70 889w	670,60 1016w	734,50 1143w	797,70 1271w	861,40 1397w	925,60 1524w	989,80 1651w	1052,10 1778w	1117,80 1905w
EH 180	€	238,10 143w	305,70 286w	372,80 429w	441,20 572w	508,50 715w	575,80 858w	643,20 1001w	711,70 1144w	778,90 1287w	846,20 1430w	913,50 1573w	980,60 1716w	1048,00 1859w	1116,40 2002w	1184,00 2145w
EH 190	€	246,00 151w	314,60 302w	383,90 453w	452,60 604w	519,90 755w	589,30 906w	657,20 1057w	727,00 1208w	795,20 1359w	863,70 1510w	933,10 1661w	1001,50 1812w	1070,20 1963w	1139,60 2114w	1207,80 2265w
EH 200	€	252,60 159w	322,20 318w	392,60 477w	462,80 636w	533,10 795w	602,40 954w	672,90 1113w	742,20 1272w	812,90 1431w	882,70 1590w	953,00 1749w	1022,80 1908w	1092,10 2067w	1162,50 2226w	1232,40 2385w
EH 210	€	258,10 167w	331,00 334w	406,00 501w	478,50 668w	552,30 835w	626,70 1002w	699,30 1169w	773,30 1336w	846,90 1503w	921,10 1670w	995,00 1837w	1067,50 2004w	1141,50 2171w	1214,40 2338w	1289,50 2505w
EH 220	€	261,50 175w	339,90 350w	415,60 525w	493,20 700w	571,50 875w	648,70 1050w	724,80 1225w	803,00 1400w	880,10 1575w	957,30 1750w	1035,70 1925w	1112,00 2100w	1189,00 2275w	1267,60 2450w	1344,40 2625w
EH 240	€	279,10 192w	360,80 384w	441,20 576w	522,50 768w	602,40 960w	684,10 1152w	764,70 1344w	846,20 1536w	926,50 1728w	1008,00 1920w	1088,50 2112w	1170,40 2304w	1251,30 2496w	1332,50 2688w	1413,00 2880w
EH 260	€	292,30 208w	377,10 416w	464,30 624w	550,40 832w	635,40 1040w	721,50 1248w	807,50 1456w	894,80 1664w	979,40 1872w	1065,20 2080w	1151,70 2288w	1236,60 2496w	1323,60 2714w	1409,60 2912w	1496,10 3120w
EH 280	€	305,70 224w	395,90 448w	487,60 672w	578,00 896w	669,80 1120w	759,80 1344w	851,70 1568w	942,40 1792w	1032,20 2016w	1124,20 2240w	1213,30 2464w	1305,00 2688w	1395,20 2912w	1486,70 3136w	1577,20 3360w
EH 300	€	325,40 240w	423,40 480w	522,50 720w	619,90 960w	718,20 1200w	816,30 1440w	915,50 1680w	1013,60 1920w	1111,00 2160w	1208,80 2400w	1307,10 2640w	1406,40 2880w	1504,50 3120w	1601,70 3360w	1699,80 3600w

Δt diversi da 50K: consultare Dati tecnici Brem

PIASTRE

Mod. Egon    collettore orizzontale    altezza cm    numero elementi  
 EH 200 - 7 EL

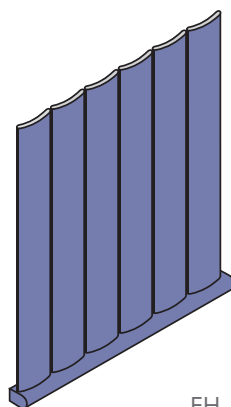

EH

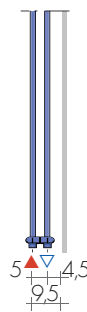

**ESECUZIONI A RICHIESTA**

Altezze piastre ogni 10 cm: ricavare le rese caloriche e i prezzi per interpolazione.

Esecuzioni su misura (±3 mm)

Rese caloriche per interpolazione:

Dimensioni oltre 1,5 el. e 3 m: a preventivo

Altezze al cm:            misura superiore +20%

**VERSIONE DOPPIA EDH**

Si uniscono due piastre EH  
 EDH                            prezzo EH x 2 + 120,10€

Attacco di serie EG (mandata sulla parte anteriore sinistra, ritorno sulla posteriore destra).  
 Rese indicative EDH: radiatore singolo x1,60

EN 442 Watt  $\Delta t$  50K ( $\Delta t$  40K =  $W \times 0,755$ ) - ( $\Delta t$  30K =  $W \times 0,526$ )

MOD.	L cm	60	80	100	120	140	160	180	200	220	240	260	280	300
H cm	▲▼ cm	57,8	77,8	97,8	117,8	137,8	157,8	177,8	197,8	217,8	237,8	257,8	277,8	297,8
EV 1el. H 8,0	€	146,70 50w	168,80 66w	182,00 83w	199,80 100w	208,30 116w	223,90 133w	238,10 149w	252,60 166w	261,50 183w	279,10 199w	292,30 216w	305,70 232w	325,40 249w
EV 2el. H 15,7	€	185,00 100w	212,80 133w	230,30 166w	250,40 199w	263,80 232w	286,90 266w	305,70 299w	323,40 332w	339,90 365w	360,80 398w	377,10 432w	395,90 465w	423,40 498w
EV 3el. H 23,5	€	223,90 149w	258,10 199w	280,40 249w	302,20 299w	320,10 349w	350,70 398w	372,80 448w	392,60 498w	415,60 548w	441,20 598w	464,30 647w	487,60 697w	522,50 747w
EV 4el. H 31,2	€	261,50 199w	302,20 266w	328,50 332w	352,90 398w	374,10 465w	414,60 531w	441,20 598w	462,80 664w	493,20 730w	522,50 797w	550,40 863w	578,00 930w	619,90 996w
EV 5el. H 39,0	€	300,10 249w	346,30 332w	377,10 415w	406,00 498w	430,00 581w	478,50 664w	508,50 747w	533,10 830w	571,50 913w	602,40 996w	635,40 1079w	669,80 1162w	718,20 1245w
EV 6el. H 46,7	€	338,70 299w	390,70 398w	427,10 498w	456,40 598w	485,50 697w	542,60 797w	575,80 896w	602,40 996w	648,70 1096w	684,10 1195w	721,50 1295w	759,80 1394w	816,30 1494w
EV 7el. H 54,5	€	375,00 349w	434,90 465w	476,60 581w	508,50 697w	539,60 813w	606,70 930w	643,20 1046w	672,90 1162w	724,80 1278w	764,70 1394w	807,50 1511w	851,70 1627w	915,50 1743w
EV 8el. H 62,2	€	413,90 398w	478,50 531w	526,40 664w	559,30 797w	595,70 930w	670,60 1062w	711,70 1195w	742,20 1328w	803,00 1461w	846,20 1594w	894,80 1726w	942,40 1859w	1013,60 1992w
EV 9el. H 70,0	€	452,60 448w	524,20 598w	575,10 747w	611,10 896w	650,60 1046w	734,50 1195w	778,90 1345w	812,90 1494w	880,10 1643w	926,50 1793w	979,40 1942w	1032,20 2092w	1111,00 2241w
EV 10el. H 77,7	€	489,60 498w	568,30 664w	623,60 830w	663,10 996w	707,00 1162w	797,70 1328w	846,20 1494w	882,70 1660w	957,30 1826w	1008,00 1992w	1065,20 2158w	1124,20 2324w	1208,80 2490w
EV 11el. H 85,5	€	528,80 548w	611,10 730w	672,90 913w	714,60 1096w	761,00 1278w	861,40 1461w	913,50 1643w	953,00 1826w	1035,70 2009w	1088,50 2191w	1151,70 2374w	1213,30 2556w	1307,10 2739w
EV 12el. H 93,3	€	565,40 598w	655,30 797w	721,50 996w	765,70 1195w	816,30 1394w	925,60 1594w	980,60 1793w	1022,80 1992w	1112,00 2191w	1170,40 2390w	1236,60 2590w	1305,00 2789w	1406,40 2988w
EV 13el. H 101,0	€	604,60 647w	699,30 863w	771,10 1079w	817,20 1295w	872,40 1511w	989,80 1726w	1048,00 1942w	1092,10 2158w	1189,00 2374w	1251,30 2590w	1323,60 2805w	1395,20 3021w	1504,50 3237w
EV 14el. H 108,8	€	642,30 697w	743,80 930w	819,60 1162w	869,40 1394w	926,50 1627w	1052,10 1859w	1116,40 2092w	1162,50 2324w	1267,60 2556w	1332,50 2789w	1409,60 3021w	1486,70 3254w	1601,70 3486w
EV 15el. H 116,5	€	679,50 747w	788,80 996w	869,40 1245w	921,10 1494w	982,10 1743w	1117,80 1992w	1184,00 2241w	1232,40 2490w	1344,40 2739w	1413,00 2988w	1496,10 3237w	1577,20 3486w	1699,80 3735w

 $\Delta t$  diversi da 50K: consultare Dati tecnici Brem

Mod. Egon  
collettore verticale  
n° el (altezza)  
lunghezza cm

EV 5 EL - 220

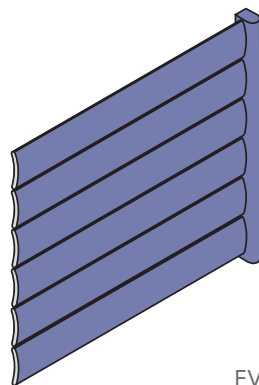

EV

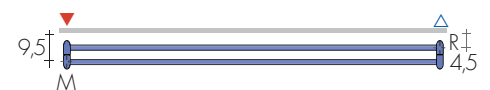

## VERSIONE DOPPIA EDV

Si uniscono due piastre EV  
EDV prezzo EV x 2 + 120,10€

Attacco di serie EG (mandata sulla parte anteriore sinistra, ritorno sulla posteriore destra).  
Rese indicative EDV: radiatore singolo x1,70

## ESECUZIONI A RICHIESTA

Lunghezze piastre ogni 10 cm: ricavare le rese caloriche e i prezzi per interpolazione.

Esecuzioni su misura ( $\pm 3$  mm)

Rese caloriche per interpolazione.

Dimensioni oltre 15 el. e 3 m: a preventivo

Lunghezze al cm: misura superiore +20%

Piastra radiante realizzata con i bordi laterali e superiore smussati per rendere il suo

spessore di soli 2,2 cm più impercettibile e sfuggente. Realizzata nei modelli verticale e

orizzontale è disponibile anche nella versione "Doppia" con tubi radianti quadrati sul retro.

## DIMENSIONI

Larghezza: da 32 a 88 cm, ogni 7cm  
 Altezze: da 169,5 a 229,5cm ogni 20cm  
 Profondità: 5,2 /7,2 cm  
 Sporgenza dal muro: 8,2 /8,7cm

## MODELLO LAH e LADH, Piastra verticale

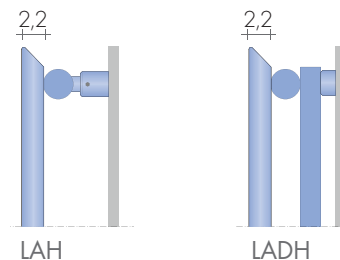
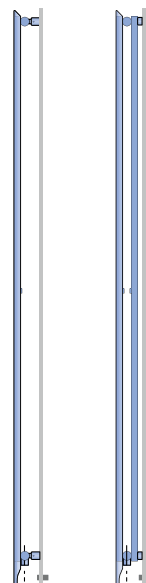
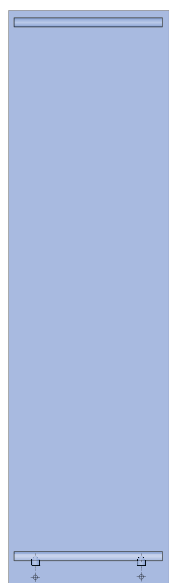
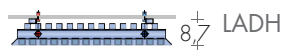
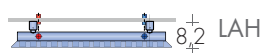

LAH

LADH

Bordi superiore e laterali delle piastre LAMINA

LAMINA è prodotto di serie con gli attacchi nascosti: usare valvole a comando laterale.

A richiesta, senza supplemento, la cover è costruita più bassa H-7,5cm per avere le valvole a vista.

LAH LADH

LAH LADH

EN 442 watt  $\Delta t$  50K ( $\Delta t$  40K =  $w \times 0,753$ ) - ( $\Delta t$  30K =  $w \times 0,524$ )

MODELLO	H cm	L cm	32	39	46	53	60	67	74	81	88
		▲▼ cm	14	21	28	35	42	49	56	63	70
LAH 170	169,5	€	754,50 567w	823,50 708w	892,70 850w	961,70 991w	1030,70 1133w	1099,90 1275w	1169,10 1416w	1238,10 1558w	1307,10 1700w
LADH 170		€	983,50 787w	1067,50 997w	1151,50 1206w	1235,20 1416w	1319,20 1625w	1403,20 1835w	1487,10 2044w	1571,10 2254w	1655,10 2464w
LAH 190	189,5	€	800,90 634w	873,50 792w	946,10 951w	1018,80 1109w	1091,40 1268w	1163,90 1426w	1236,70 1584w	1309,20 1743w	1381,80 1902w
LADH 190		€	1046,40 882w	1134,30 1117w	1222,40 1352w	1310,30 1586w	1398,30 1821w	1486,40 2056w	1574,30 2291w	1662,30 2525w	1750,30 2759w
LAH 210	209,5	€	847,40 701w	923,50 876w	999,70 1051w	1075,90 1227w	1152,00 1402w	1228,20 1577w	1304,40 1752w	1380,50 1928w	1456,70 2104w
LADH 210		€	1109,40 977w	1201,30 1237w	1293,40 1497w	1385,30 1757w	1477,30 2017w	1569,30 2277w	1661,30 2537w	1753,20 2797w	1845,20 3057w
LAH 230	229,5	€	893,70 768w	973,50 960w	1053,20 1152w	1132,90 1344w	1212,60 1536w	1292,30 1728w	1372,00 1920w	1451,70 2112w	1531,40 2304w
LADH 230		€	1172,20 1072w	1268,30 1357w	1364,30 1642w	1460,40 1928w	1556,40 2213w	1652,40 2498w	1748,40 2784w	1844,40 3069w	1940,40 3354w

$\Delta t$  diversi da 50K: consultare Dati tecnici Brem

## ORDINE

Indicare: il modello (LAH indica verticale) l'altezza e larghezza in cm ; l'allacciamento e il colore se diversi dall'esecuzione di serie es.: LAH 210 - 46, EG  $\varnothing$  1/2", RAL 3005

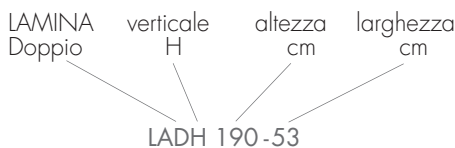

ACCESSORI MAGNETICI pag. 277

## ESECUZIONI DI SERIE

Colore bianco sablé SB9016, mensole bianche  
 Valvola di sfiato  $\varnothing$  1/2" - Tolleranze  $\pm$  3mm  
 Pressione massima d'esercizio 6 BAR

## ESECUZIONI A RICHIESTA

Verniciatura tabella colori Brem con fissaggi colorati +15/25%  
 Colorazione BICOLOR pag.99

## ATTACCHI DI SERIE

EG  $\varnothing$  1/2"  
 Attacchi speciali, pag. 278  
 Versione elettrica non disponibile



**INTERASSE ATTACCHI**  
MODELLO LAH e LADH, Piastra verticale

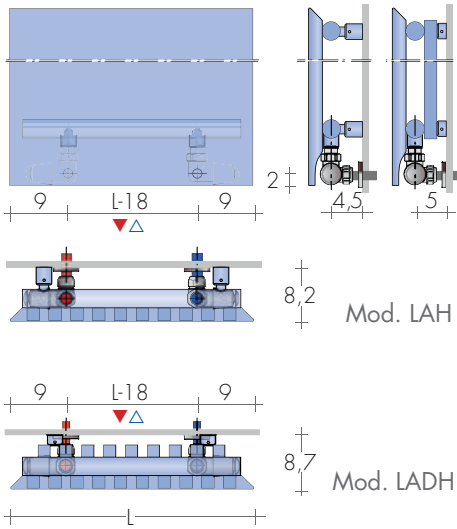

\*COLORAZIONE BICOLOR: Cover colore BREM con fianco e retro colore bianco per integrarsi alla parete

**FISSAGGI**  
Mensole comprese

Mod. mensola	a	b	c
LAH G30	7,2	3,7	9,2
LADH B15	7,2	3,7	9,2

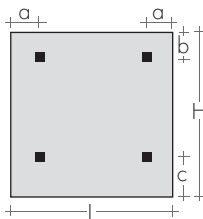

**VALVOLE CONSIGLIATE**

KIT VALVOLE CROMATE comprende:

- n°2 Valvole con codoli
- n°2 Raccordi (per multistrato ø16 e rame ø12 e 14)
- n°2 Rosette tonde cromo ø 48, foro ø16

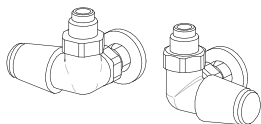

KIT VALVOLE TON comando LATERALE nichelate  
volantino cromo Art. KVLN 97,00€

KIT VALVOLE TON comando LATERALE cromo  
pag.269 Art. KVL 139,20€

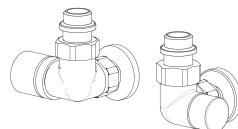

KIT VALVOLE CYL termostattabile comando  
LATERALE, pag.273 Art. KCLD 150,50€  
Colore tabella BREM supplemento 49,50€

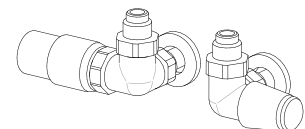

KIT VALVOLE TON comando LATERALE nichelate,  
testa TERMOSTATICA, Art. KTLND 143,80€

KIT VALVOLE TON comando LATERALE cromo, testa  
TERMOSTATICA, pag.269 Art. KTLD 188,60€



FINITURE SPECIALI: Oro, Bronzo, Nickel spazzolato, Foglia O/A per 2 valvole pag. 267  
KIT Raccordi NICKEL spazz. suppl.Art. RN 28,20€

\*COLORAZIONE BICOLOR:  
BIC10 Cover della piastra in colore Brem a scelta con collettori e retro bianco sablé SB 9016 +10%  
BIC20 Cover in colore Brem a scelta con collettori e retro sablé nero SB9005 o grigio sablé SB7039+20%  
BIC35 N° 2 colori Brem a scelta +35%

Versione orizzontale della piastra LAMINA realizzata con l'esclusivo bordo rastremato

che la rende unica. È progettata anche nella versione "Doppia" con tubi radianti quadrati

sul retro e per nascondere le valvole con cui è collegata all'impianto di riscaldamento.

## DIMENSIONI

Altezze: da 58,5 a 86,5 cm  
Lunghezze: da 54 a 204 cm  
Profondità: 5,2 / 7,2 cm  
Sporgenza dal muro: 8,2 / 8,7 cm

MODELLO LAV e LADV, Piastra orizzontale

LAV Piastra orizzontale e collettori verticali



LADV Piastra orizzontale con tubi doppi

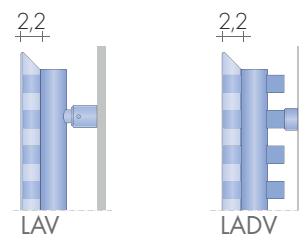

Bordi superiore e laterali delle piastre LAMINA

LAMINA è prodotto di serie con gli attacchi nascosti: usare valvole a comando laterale. A richiesta, senza supplemento, la cover è costruita più bassa H-7,5cm per avere le valvole a vista.

EN 442 Watt  $\Delta t$  50K ( $\Delta t$  40K =  $W \times 0,755$ ) - ( $\Delta t$  30K =  $W \times 0,526$ )

MODELLO	H cm	L cm	54	64	74	84	94	104	124	144	164	184	204
LAV 59	58,5	36	739,20 349w	776,90 408w	814,70 468w	852,70 528w	890,40 587w	928,10 647w	965,90 766w	1003,60 885w	1041,40 1004w	1079,20 1123w	1117,00 1242w
LADV 59	58,5	46	924,10 499w	976,40 589w	1028,60 678w	1081,00 768w	1133,30 858w	1185,50 947w	1237,80 1126w	1290,10 1305w	1342,40 1485w	1394,70 1664w	1446,90 1843w
LAV 66	65,5	36	772,90 399w	813,30 467w	853,90 535w	894,50 603w	934,90 671w	975,40 739w	1015,90 875w	1056,40 1012w	1096,90 1148w	1137,40 1284w	1177,90 1420w
LADV 66	65,5	46	981,40 571w	1039,30 673w	1097,10 775w	1155,10 878w	1213,00 981w	1270,80 1083w	1328,80 1287w	1386,70 1492w	1444,60 1697w	1502,50 1902w	1560,30 2107w
LAV 73	72,5	36	806,50 449w	849,70 525w	893,00 602w	936,20 678w	979,40 755w	1022,70 831w	1065,90 984w	1109,10 1138w	1152,40 1291w	1195,60 1444w	1238,80 1597w
LADV 73	72,5	46	1038,60 642w	1102,10 757w	1165,60 872w	1229,10 987w	1292,60 1103w	1356,10 1218w	1419,70 1448w	1483,20 1678w	1546,70 1909w	1610,20 2139w	1673,70 2370w
LAV 80	79,5	36	849,70 499w	896,90 584w	943,90 669w	990,80 754w	1037,90 839w	1085,00 924w	1132,00 1094w	1179,00 1264w	1226,00 1434w	1273,00 1604w	1320,10 1774w
LADV 80	79,5	46	1073,80 713w	1140,50 841w	1207,20 969w	1273,80 1097w	1340,50 1225w	1407,30 1353w	1473,80 1609w	1540,70 1865w	1607,30 2121w	1673,80 2377w	1740,70 2633w
LAV 87	86,5	36	892,90 549w	944,00 643w	994,70 736w	1045,40 830w	1096,30 923w	1147,30 1017w	1198,00 1204w	1248,80 1390w	1299,60 1577w	1350,30 1764w	1401,40 1951w
LADV 87	86,5	46	1109,00 784w	1178,80 925w	1248,80 1066w	1318,50 1207w	1388,30 1347w	1458,40 1488w	1527,90 1770w	1598,10 2052w	1667,80 2333w	1737,40 2615w	1807,70 2896w

$\Delta t$  diversi da 50K: consultare Dati tecnici Brem

## ORDINE

Indicare: il modello (LAV indica orizzontale) l'altezza e larghezza in cm; l'allacciamento e il colore se diversi dall'esecuzione di serie es.: LAV 66 - 124, EG  $\varnothing$  1/2", RAL 3005



## ESECUZIONI DI SERIE

Colore bianco sablé SB9016, mensole bianche  
Valvola di sfiato  $\varnothing$  1/2" - Tolleranze  $\pm$  3mm  
Pressione massima d'esercizio 6 BAR

## ESECUZIONI A RICHIESTA

Verniciatura tabella colori Brem con fissaggi colorati +15/25%  
Colorazione BICOLOR pag. 101

## ATTACCHI DI SERIE

EG  $\varnothing$  1/2"  
Attacchi speciali, pag. 279  
Versione elettrica non disponibile



## INTERASSE ATTACCHI

Attacchi di serie EG

Utilizzare valvole a comando laterale

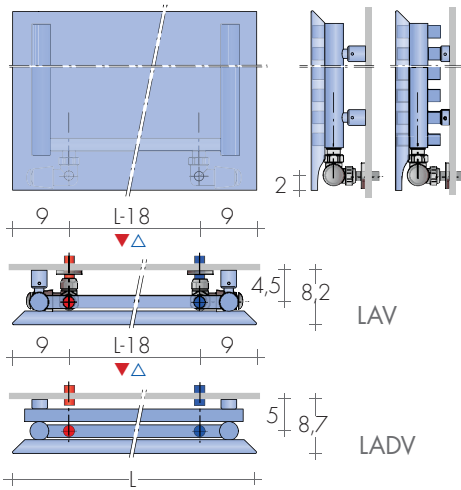

## FISSAGGI

Mensole comprese

Mod. mensola	a	b	c
LAV G30	3,7	7,2	12,7
LADV B15	3,7	7,2	12,7

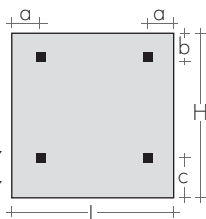

## VALVOLE CONSIGLIATE

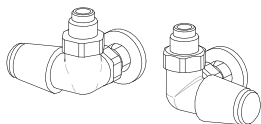

KIT VALVOLE TON comando LATERALE nichelate  
volantino cromo Art. KVLN 97,00€  
KIT VALVOLE TON comando LATERALE cromo  
pag.269 Art. KVL 139,20€

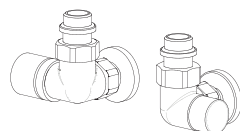

KIT VALVOLE CYL termostattizzabile comando  
LATERALE, pag.273 Art. KCLD 150,50€  
Colore tabella BREM supplemento 49,50€

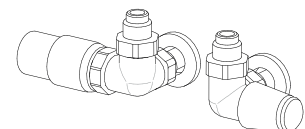

KIT VALVOLE TON comando LATERALE nichelate,  
testa TERMOSTATICA, Art. KTLND 143,80€  
KIT VALVOLE TON comando LATERALE cromo, testa  
TERMOSTATICA, pag.269 Art. KTLD 188,60€



LAMINA LAV 73-164

OPEN è la piastra dai tubi piatti saldati ai collettori posti sul retro per evidenziare la superficie radiante completamente piana,

ritmata dall'intervallo dei vari tubi radianti. OPEN è costruita orizzontale e verticale, semplice o doppia e con lamelle sul retro.

Altezze: da 60 a 240 cm  
 Larghezze: da 28,9 a 93,2 cm (n° el. x 7,15 + 0,25)  
 Profondità: 4,3 / 6 / 5,3 cm  
 Sporgenza dal muro: 6,8 / 7,5 cm



**OH**  
 Piastra verticale  
 e collettori orizzontali



**OLH**  
 Piastra verticale  
 con lamelle



**OH2**  
 Piastra verticale  
 doppia

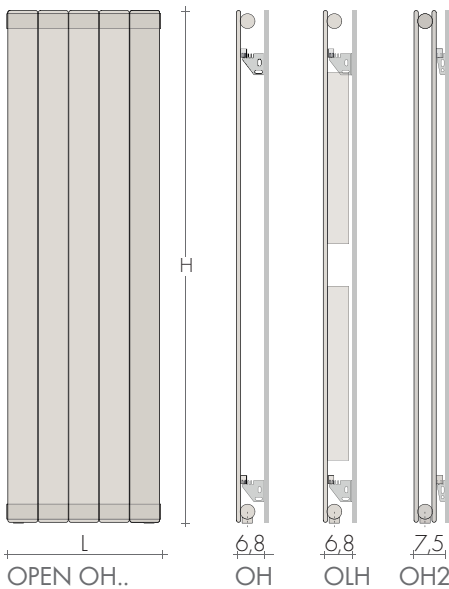

### INTERASSE ALLACCIAMENTI OPEN OH

Di serie attacchi EG verticali  
 A richiesta attacchi laterali, senza supplemento

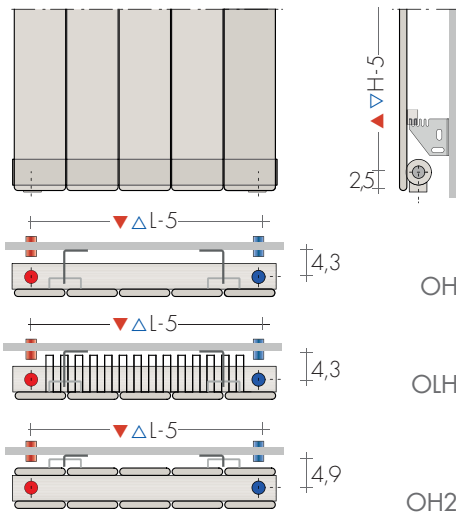

Open con lamelle    piastra verticale    altezza cm    n° elementi  
 OLH 180-7el

### ORDINE

Indicare: il modello (L indica la lamellatura)  
 l'altezza in cm il n° elementi; l'allacciamento  
 e il colore se diversi dall'esecuzione di serie  
 es.: OLH 180-7e, EG ø 1/2", RAL 3005

### ESECUZIONI DI SERIE

Colore bianco sablé SB9016 fissaggi EOS  
 Valvola di sfiato ø 1/2" - Tolleranze ± 3mm  
 Pressione massima d'esercizio 6 BAR

### ALTEZZE A RICHIESTA

Altezze ogni 10 cm: interpolare rese e prezzi  
 Altezze su misura ogni 1 cm: interpolare rese,  
 prezzi: misura superiore + 20%

### ESECUZIONI A RICHIESTA

Verniciatura tabella colori Brem fino a 3 mt  
 con fissaggi colorati +15/25%  
 Dimensioni non in tabella a richiesta



### FISSAGGI

Mensole comprese



Mensola EOS

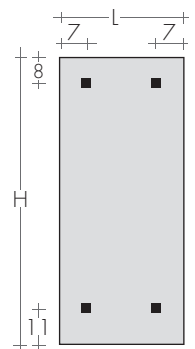

### ATTACCHI DI SERIE

EG ø 1/2"  
 A richiesta attacchi AC o BD  
 Attacchi speciali, pag. 278



MODELLO H cm	n°el. L cm	EN 442 Watt Δt 50K (Δt 40K = Wx0,755) - (Δt 30K = Wx0,526)									
		4	5	6	7	8	9	10	11	12	13
		28,9	36	43,2	50,3	57,5	64,6	71,8	78,9	86,1	93,2
	i.a. ▲▼ cm	23,9	31	38,2	45,3	52,5	59,6	66,8	73,9	81,1	88,2
OH 60	€	223,80 184w	254,30 230w	284,90 276w	315,30 322w	345,80 368w	376,20 414w	406,80 460w	437,20 506w	467,70 552w	498,30 598w
OLH 60	€	341,70 284w	374,00 355w	406,00 426w	438,20 497w	470,30 568w	502,40 639w	534,50 710w	566,50 781w	598,80 852w	630,80 923w
OH2 60	€	538,80 268w	599,90 335w	661,20 402w	722,60 469w	783,80 536w	845,10 603w	906,50 670w	967,70 737w	1029,10 804w	1090,30 871w
OH 80	€	246,00 240w	280,60 300w	315,10 360w	349,70 420w	384,00 480w	418,50 540w	453,10 600w	487,50 660w	522,10 720w	556,60 780w
OLH 80	€	399,70 352w	437,90 440w	475,90 528w	514,00 616w	552,20 704w	590,20 792w	628,40 880w	666,40 968w	704,60 1056w	742,70 1144w
OH2 80	€	583,00 348w	652,30 435w	721,60 522w	790,90 609w	860,40 696w	929,70 783w	999,00 870w	1068,30 957w	1137,70 1044w	1207,00 1131w
OH 100	€	268,40 296w	306,80 370w	345,30 444w	383,80 518w	422,20 592w	460,70 666w	499,20 740w	537,70 814w	576,10 888w	614,70 962w
OLH 100	€	501,90 420w	546,60 525w	591,40 630w	636,10 735w	680,60 840w	725,20 945w	770,10 1050w	814,60 1155w	859,20 1260w	904,10 1365w
OH2 100	€	627,70 428w	705,00 535w	782,30 642w	859,60 749w	936,90 856w	1014,30 963w	1091,70 1070w	1169,10 1177w	1246,40 1284w	1323,70 1391w
OH 160	€	337,30 464w	387,60 580w	437,50 696w	487,70 812w	538,00 928w	588,10 1044w	638,20 1160w	688,40 1276w	738,60 1392w	788,80 1508w
OLH 160	€	612,80 612w	671,90 765w	730,60 918w	789,60 1071w	848,50 1224w	907,40 1377w	966,30 1530w	1025,30 1683w	1084,10 1836w	1143,10 1989w
OH2 160	€	761,60 664w	862,30 830w	963,00 996w	1063,80 1162w	1164,70 1328w	1265,40 1494w	1366,20 1660w	1466,90 1826w	1567,80 1992w	1668,50 2158w
OH180	€	357,90 520w	411,90 650w	465,70 780w	519,60 910w	573,50 1040w	627,40 1170w	681,20 1300w	735,30 1430w	789,20 1560w	843,00 1690w
OLH 180	€	650,30 676w	711,90 845w	773,50 1014w	835,40 1183w	897,00 1352w	958,70 1521w	1020,50 1690w	1082,10 1859w	1143,80 2028w	1205,60 2197w
OH2 180	€	806,10 740w	914,30 925w	1022,60 1110w	1130,90 1295w	1239,10 1480w	1347,50 1665w	1455,70 1850w	1564,00 2035w	1672,20 2220w	1780,50 2405w
OH 200	€	380,00 576w	437,90 720w	495,80 864w	553,60 1008w	611,40 1152w	669,40 1296w	727,20 1440w	785,10 1584w	843,00 1728w	900,90 1872w
OLH 200	€	743,80 740w	815,60 925w	887,80 1110w	959,70 1295w	1031,50 1480w	1103,60 1665w	1175,60 1850w	1247,50 2035w	1319,40 2220w	1391,50 2405w
OH2 200	€	850,70 820w	966,90 1025w	1083,30 1230w	1199,40 1435w	1315,70 1640w	1432,00 1845w	1548,20 2050w	1664,50 2255w	1780,70 2460w	1897,00 2665w
OH 220	€	402,40 632w	464,30 790w	526,20 948w	588,00 1106w	650,00 1264w	711,80 1422w	773,50 1580w	835,60 1738w	897,40 1896w	959,20 2054w
OLH 220	€	805,10 804w	885,00 1005w	965,20 1206w	1045,20 1407w	1125,30 1608w	1205,40 1809w	1285,40 2010w	1365,40 2211w	1445,40 2412w	1525,50 2613w
OH2 220	€	893,20 896w	1017,30 1120w	1141,20 1344w	1265,30 1568w	1389,30 1792w	1513,30 2016w	1637,30 2240w	1761,40 2464w	1885,20 2688w	2009,30 2912w
OH 240	€	424,80 688w	490,70 860w	556,40 1032w	622,20 1204w	688,30 1376w	754,10 1548w	819,90 1720w	885,70 1892w	951,60 2064w	1017,60 2236w
OH2 240	€	935,90 972w	1067,60 1215w	1199,30 1458w	1331,20 1701w	1462,80 1944w	1594,60 2187w	1726,20 2430w	1858,10 2673w	1989,60 2916w	2121,50 3159w

Δt diversi da 50K: consultare Dati tecnici Brem

## VALVOLE CONSIGLIATE

KIT VALVOLE CROMATE comprende:

- n°2 Valvole con codali
- n°2 Raccordi (per multistrato ø16 e rame ø12 e 14)
- n°2 Rosette tonde cromo ø 48, foro ø16

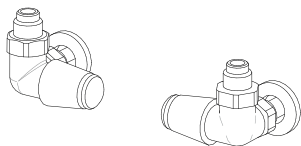

KIT VALVOLE TON comando LATERALE  
pag.269 Art. KVL 139,20€

FINITURE SPECIALI

Finiture Oro, Bronzo, Nickel spazzolato per 2 valvole

KIT Raccordi NICKEL spazz. suppl. Art. RN 28,20€

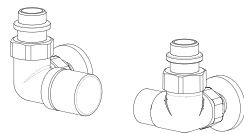

KIT VALVOLE CYL termostatzabile con comando  
LATERALE, pag.273 Art. KCL 150,50€  
Colore tabella BREM supplemento 49,50€

pag. 267

ATTACCHI REMOTI

Interasse attacchi sul retro: ▲▼ L - 5 cm

Valvole REMOTE pag. 274

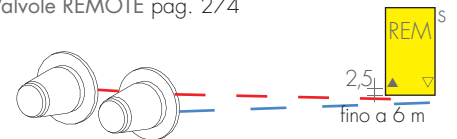

KIT VALVOLE TON comando LATERALE con testa  
TERMOSTATICA, pag. 269 Art. KTL 188,60€

OPEN è la piastra dai tubi piatti saldati ai collettori posti sul retro per evidenziare la

superficie radiante completamente piana, ritmata dall'intervallo dei vari tubi radianti.

OPEN è costruita con tubi orizzontali, semplice o doppia e con lamelle sul retro.

Altezze: da 50,3 a 93,32 cm (da 7 a 13 el.)  
Lunghezze: da 50 a 220 cm  
Profondità: 4,3 / 6 / 5,3 cm  
Sporgenza dal muro: 6,8 / 7,5 cm

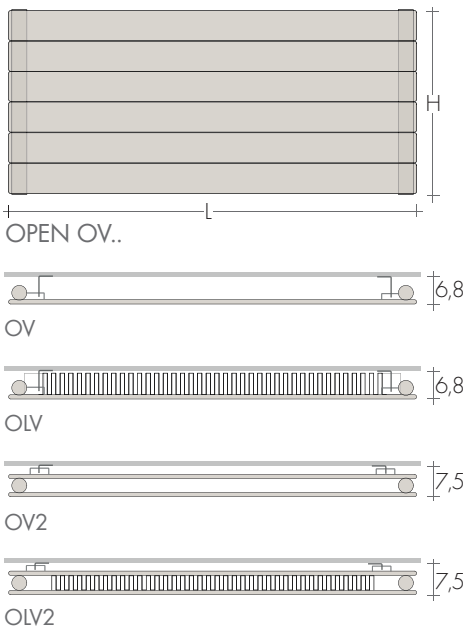

EN 442 Watt  $\Delta t$  50K ( $\Delta t$  40K =  $W \times 0,755$ ) - ( $\Delta t$  30K =  $W \times 0,526$ )

MODELLO	L cm	50	60	70	80	90	100	120	140	160	180	200	220
	i.a. ▲ ▽	cm 45	55	65	75	85	95	115	135	155	175	195	215
OV 7 el	H 50,3	€ 302,30 264w	319,20 316w	336,00 369w	353,00 422w	369,90 474w	386,80 527w	420,50 632w	454,20 738w	488,00 843w	521,70 949w	555,60 1054w	589,40 1159w
OLV 7 el		€ 426,60 431w	455,60 517w	484,50 603w	513,50 689w	542,50 775w	571,50 861w	629,40 1033w	687,30 1205w	745,30 1378w	803,30 1550w	861,10 1722w	919,00 1894w
OV2 7 el		€ 695,80 415w	729,20 498w	762,80 581w	796,20 664w	829,60 747w	863,00 830w	929,90 996w	996,80 1162w	1063,70 1328w	1130,60 1494w	1197,50 1660w	1264,30 1826w
OLV2 7 el		€ 785,40 535w	826,60 642w	867,60 749w	908,70 856w	949,70 963w	991,00 1070w	1073,20 1284w	1155,40 1498w	1237,70 1712w	1319,90 1926w	1402,10 2140w	1484,40 2354w
OV 9 el	H 64,6	€ 351,90 333w	372,40 399w	393,20 466w	413,90 532w	434,60 599w	455,40 665w	496,70 798w	538,10 931w	579,40 1064w	620,90 1197w	662,30 1330w	703,60 1463w
OLV 9 el		€ 472,80 540w	506,30 648w	539,90 756w	573,50 864w	607,20 972w	640,80 1080w	708,00 1296w	775,20 1512w	842,40 1728w	909,70 1944w	976,90 2160w	1044,10 2376w
OV2 9 el		€ 795,70 519w	836,60 623w	877,80 727w	918,90 830w	960,00 934w	1001,20 1038w	1083,40 1246w	1165,60 1453w	1247,90 1661w	1330,00 1868w	1412,40 2076w	1494,70 2284w
OLV2 9 el		€ 905,50 645w	958,80 774w	1012,10 903w	1065,10 1032w	1118,50 1161w	1171,70 1290w	1278,10 1548w	1384,50 1806w	1491,00 2064w	1597,50 2322w	1703,80 2580w	1810,40 2838w
OV 10 el	H 71,8	€ 384,80 367w	408,00 440w	431,10 514w	454,20 587w	477,40 661w	500,60 734w	547,10 881w	593,40 1028w	639,70 1174w	686,10 1321w	732,50 1468w	778,90 1615w
OLV 10 el		€ 505,80 595w	542,00 713w	577,90 832w	613,90 951w	650,20 1070w	686,20 1189w	758,40 1427w	830,40 1665w	902,60 1902w	974,70 2140w	1047,00 2378w	1119,10 2616w
OV2 10 el		€ 861,10 571w	907,10 685w	953,20 799w	999,30 914w	1045,20 1028w	1091,30 1142w	1183,40 1370w	1275,50 1599w	1367,50 1827w	1459,70 2056w	1551,80 2284w	1643,90 2512w
OLV2 10 el		€ 939,40 700w	997,50 840w	1055,80 980w	1113,90 1120w	1172,00 1260w	1230,20 1400w	1346,50 1680w	1462,80 1960w	1579,10 2240w	1695,30 2520w	1811,60 2800w	1927,90 3080w
OV 12 el	H 86,1	€ 448,40 436w	475,30 523w	502,40 610w	529,40 698w	556,40 785w	583,50 872w	637,60 1046w	691,50 1221w	745,70 1395w	799,70 1570w	853,90 1744w	907,90 1918w
OLV 12 el		€ 570,90 704w	611,10 844w	651,10 985w	691,20 1126w	731,40 1266w	771,30 1407w	851,40 1688w	931,70 1970w	1011,80 2251w	1091,90 2533w	1172,00 2814w	1252,10 3095w
OV2 12 el		€ 989,00 675w	1042,70 810w	1096,40 945w	1150,30 1080w	1204,00 1215w	1257,90 1350w	1365,40 1620w	1473,00 1890w	1580,60 2160w	1688,20 2430w	1795,50 2700w	1903,10 2970w
OLV2 12 el		€ 1041,40 810w	1109,10 972w	1176,90 1134w	1244,70 1296w	1312,30 1458w	1380,10 1620w	1515,70 1944w	1651,00 2268w	1786,40 2592w	1922,00 2916w	2057,40 3240w	2192,90 3564w
OV 13 el	H 93,2	€ 476,00 471w	505,10 565w	534,20 659w	563,40 753w	592,50 847w	621,60 941w	679,90 1129w	738,00 1317w	796,40 1506w	854,60 1694w	912,90 1882w	971,10 2070w
OV2 13 el		€ 1044,20 727w	1102,20 872w	1160,10 1018w	1218,10 1163w	1276,20 1309w	1334,00 1454w	1449,90 1745w	1565,90 2036w	1681,80 2326w	1797,70 2617w	1913,60 2908w	2029,70 3199w

### ESECUZIONI DI SERIE

Colore bianco sablé SB9016 fissaggi EOS  
Valvola di sfiato ø 1/2" - Tolleranze ± 3mm  
Pressione massima d'esercizio 6 BAR

### ESECUZIONI A RICHIESTA

Verniciatura tabella colori Brem fino a 3 mt  
con fissaggi colorati +15/25%  
Dimensioni non in tabella a richiesta

### ATTACCHI DI SERIE

EG ø 1/2"  
A richiesta attacchi AC o BD  
Attacchi speciali, pag. 278

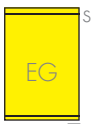

### INTERASSE ALLACCIAMENTI

Di serie attacchi EG verticali

A richiesta attacchi laterali, senza supplemento

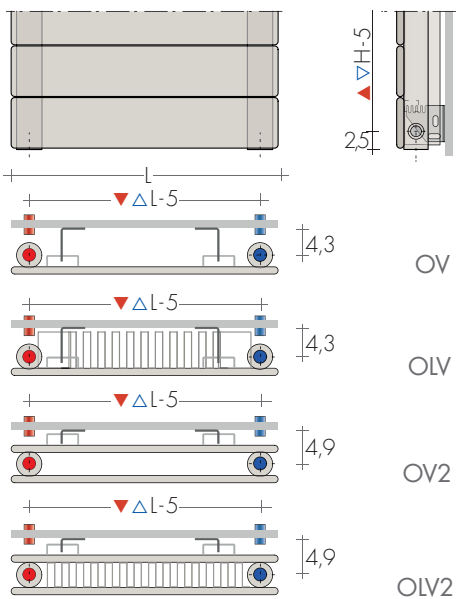

OLV lamelle alte 7 cm meno della piastra

### FISSAGGI

Mensole comprese



Mensola EOS

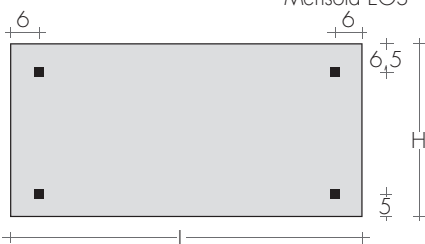

### VALVOLE CONSIGLIATE

KIT VALVOLE CROMATE comprende:

- n°2 Valvole con codoli
- n°2 Raccordi (per multistrato ø16 e rame ø12 e 14)
- n°2 Rosette tonde cromo ø 48, foro ø16

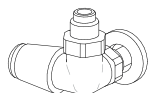

KIT VALVOLE TON comando LATERALE pag.269

Art. KVL 139,20€

FINITURE SPECIALI

Finiture Oro, Bronzo, Nickel spazzolato per 2 valvole pag. 267

KIT Raccordi NICKEL spazz. suppl.Art. RN 28,20€

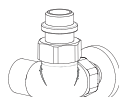
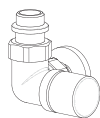

KIT VALVOLE CYL termostattabile con comando LATERALE, pag.273 Art. KCL 150,50€  
Colore tabella BREM supplemento 49,50€

ATTACCHI REMOTI Art. REM 37,60€

Interasse attacchi sul retro:  $\nabla$  L - 5 cm

Valvole REMOTE pag. 274

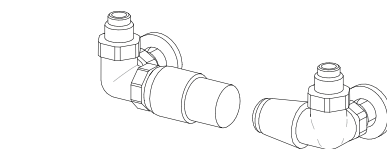
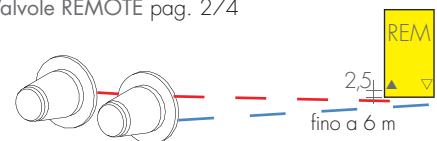

KIT VALVOLE TON comando LATERALE con testa TERMOSTATICA, pag. 269 Art. KTL 188,60€



OPEN OV2 4el-140

# PHUL

## CALORIFERI & SCALDASALVIETTE

PREZZI DAL 01.03.2026 **+5%**

La gamma di piastre PHUL con i 3 lati smussati riscalda dai piccoli ambienti fino ai

grandi spazi. L'essenzialità è il motto più evidente e per assolvere alle varie funzionalità

del vivere quotidiano, una serie completa di accessori magnetici ci assiste.

### DIMENSIONI

Larghezze 44/54/59 cm

Altezze 80/96/100/120/144/160/176/200/216 cm

Profondità 5,2 cm

Sporgenza dal muro 8,2 cm

A richiesta versione H- 6 cm per valvole a vista

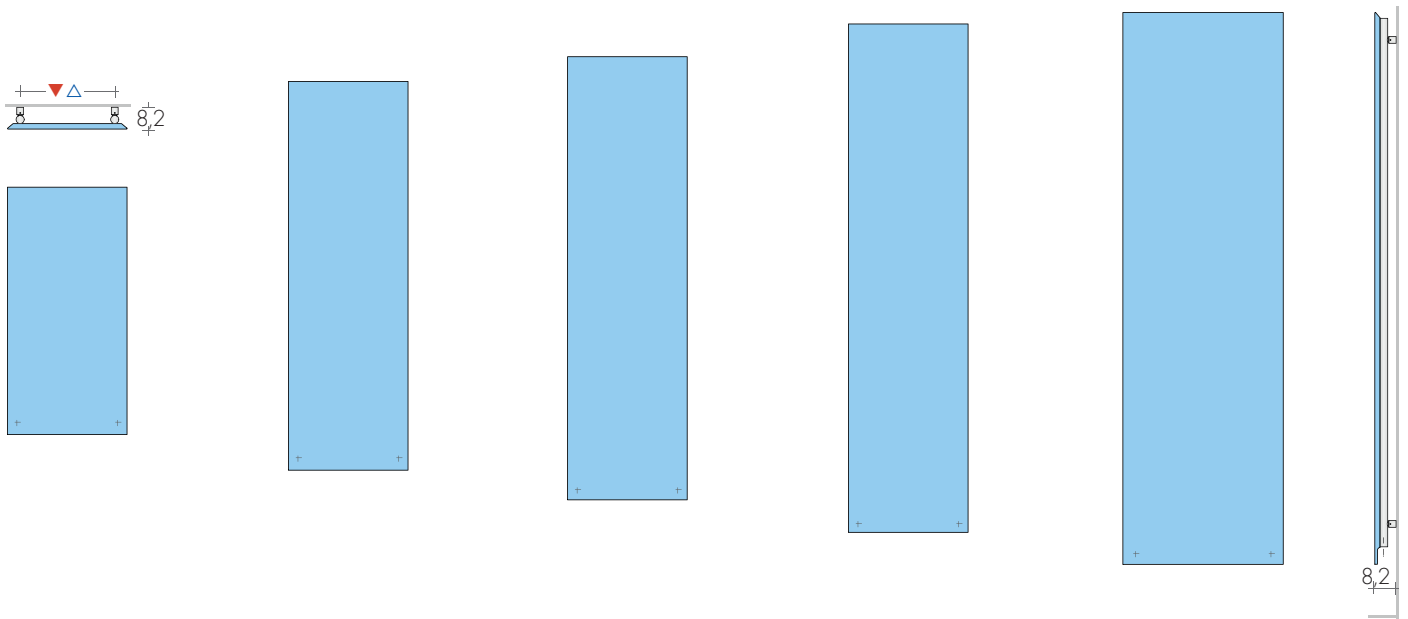

PHUL 80-..  
PHUL 96-..  
PHUL 100-..

PHUL 120-44  
PHUL 120-54

PHUL 144-44  
PHUL 160-44

PHUL 176-54  
PHUL 216-54

PHUL 200-59

### MODELLO

MODELLO	H - L cm	Bianco di serie sablé SB 9016 €	EN 442			▲ ▽ int.att. cm	Altezza		Peso M Kg	Volume V dm <sup>3</sup>	VERSIONI MISTE con Resistenza e * Watt €	
			Δt 50K watt	Δt 40K watt	Δt 30K watt		H cm	L cm				
PHUL	80-44	542,80	409	309	215	35	80,5	44	10,0	3,1	400	95,70
PHUL	80-54	595,60	492	371	259	45	80,5	54	12,0	3,7	500	97,80
PHUL	96-44	611,00	500	378	263	35	96,5	44	12,2	3,8	500	97,80
PHUL	100-54	648,50	629	475	331	45	100,5	54	15,3	4,7	650	99,80
PHUL	120-44	666,90	637	481	335	35	120,5	44	15,4	4,9	650	99,80
PHUL	120-54	710,50	765	578	402	45	120,5	54	18,5	5,8	800	104,20
PHUL	144-44	733,10	773	584	407	35	144,5	44	18,6	5,9	800	104,20
PHUL	160-44	773,60	864	652	454	35	160,5	44	20,7	6,6	900	107,50
PHUL	176-54	961,70	1148	867	604	45	176,5	54	27,6	8,6	1200	107,50
PHUL	200-59	1121,70	1422	1074	748	50	200,5	59	34,1	10,6	1500	115,20
PHUL	216-54	1144,10	1421	1073	747	45	216,5	54	34,1	10,6	1500	115,20

\* Aggiungere: Valvola mista p.207  
Termostati p.208-209

### PORTA-SALVIETTE RAM

Porta-salviette magnetico pag. 277  
(35X44x7 cm) Art. RAM 155,30€



**MAGNET** pag. 277  
Maniglione magnetico  
(40x3,3x6,2 cm) Art. MAG40 129,00€  
(50x3,3x6,2 cm) Art. MAG50 133,00€

**APPENDINI**  
magnetici pag.277  
cad. 87,40€



### ESECUZIONI DI SERIE

Colore bianco sablé SB9016, mensola G30  
Valvola di sfiato ø 1/2"- Tolleranze ± 3mm  
Pressione massima d'esercizio 6 BAR

### ESECUZIONI A RICHIESTA

Verniciatura tabella colori Brem con fissaggi colorati +15/25%  
Colorazione BICOLOR pag.107

### ATTACCHI DI SERIE

EG ø 1/2"  
Attacchi speciali, pag. 279  
Versione elettrica e.PHUL p.247

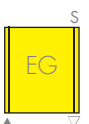

**INTERASSE ATTACCHI**

Attacchi di serie EG

Utilizzare valvole a comando laterale

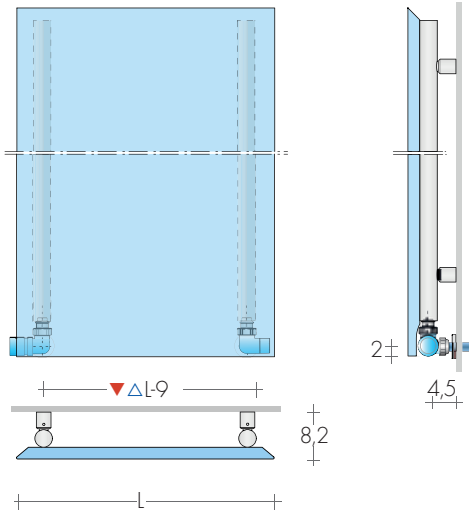

**VERSIONI MISTE**

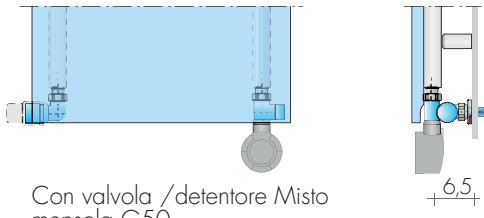

Con valvola /detentore Misto mensola G50

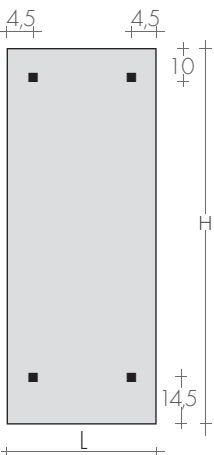

**FISSAGGI**  
Mensola G30  
comprese



PIASTRE

**VALVOLE CONSIGLIATE**

KIT VALVOLE CROMATE comprende:

- n°2 Valvole con codali
- n°2 Raccordi (per multistrato ø16 e rame ø12 e 14)
- n°2 Rosette tonde cromo ø 48, foro ø16

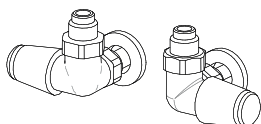

KIT VALVOLE TON comando LATERALE nichelate  
volantino cromo Art. KVLN 97,00€

KIT VALVOLE TON comando LATERALE cromo  
pag.269 Art. KVL 139,20€

**FINITURE SPECIALI**

pag. 267  
Finiture Oro, Bronzo, Nickel spazzolato per 2 valvole  
KIT Raccordi NICKEL spazz. suppl.Art. RN 28,20€

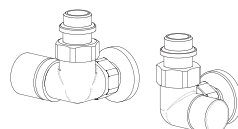

KIT VALVOLE CYL termostattizzabile comando  
LATERALE, pag.273 Art. KCLD 150,50€  
Colore tabella BREM supplemento 49,50€

**COLORAZIONE BICOLOR:**

BIC10 Cover della piastra in colore Brem a scelta  
con collettori e retro bianco sablé SB 9016 +10%  
BIC20 Cover in colore Brem a scelta con collettori e  
retro sablé nero SB9005 o grigio sablé SB7039+20%  
BIC35 N° 2 colori Brem a scelta +35%

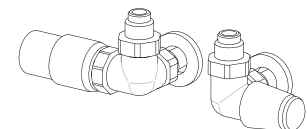

KIT VALVOLE TON comando LATERALE nichelate,  
testa TERMOSTATICA, Art. KTIND 143,80€

KIT VALVOLE TON comando LATERALE cromo, testa  
TERMOSTATICA, pag.269 Art. KTLD 188,60€

# SO-FLEX CALORIFERI & SCALDASALVIETTE

PREZZI DAL 01.03.2026 +5%

Al di là del solito concetto di scaldasalviette, che chiama ordine e piegatura, SO-FLEX

afferma un concetto nuovo: il disordine pratico, la disinvoltura nei gesti, l'allegria di non

*design Gabriella Almagioni*  
piegare tutto ma di buttare un asciugamano usato in un accogliente guscio caldo.

## DIMENSIONI

Larghezze 45/54/63/72/120 cm

Altezze 63/130/180/200 cm

Profondità 11 cm

Sporgenza dal muro 14 cm

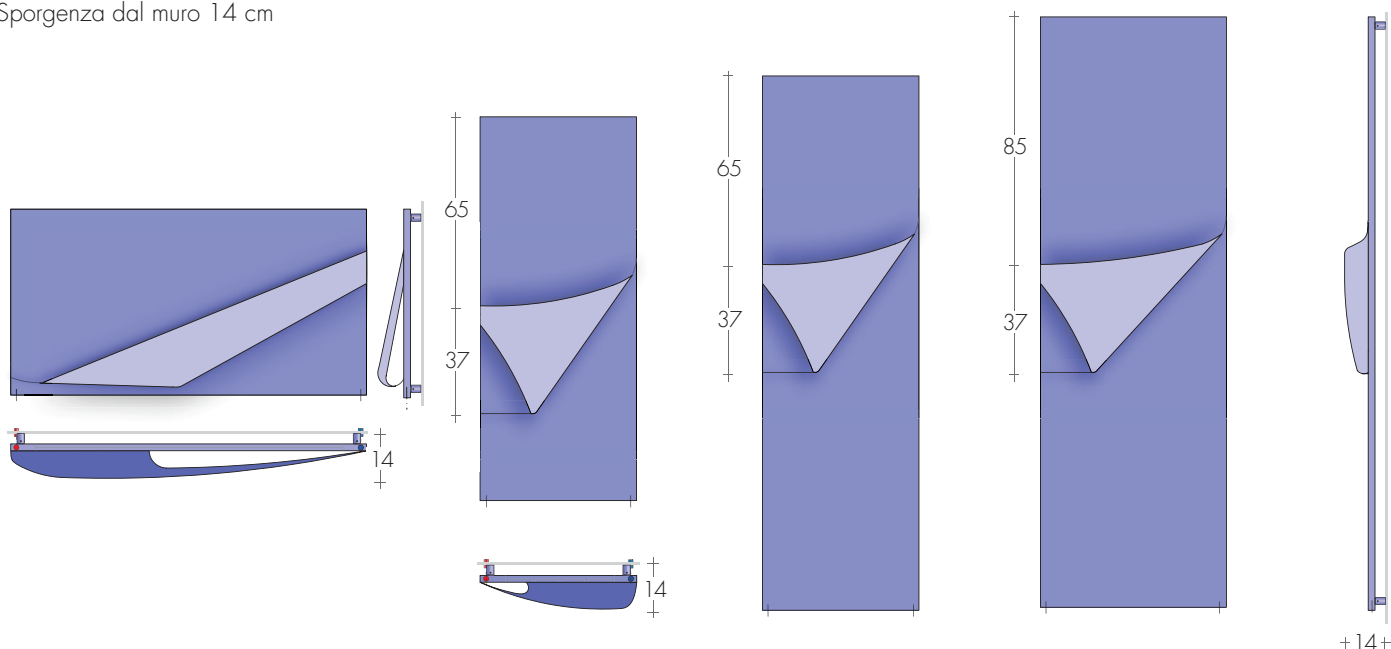

### FXV 63-120

### FXH 130-..

### FXH/FXLH 180-..

### FXH/FXLH 200-..

MODELLO	H-L cm	Bianco di serie sablé SB9016 €	EN 442			▲ ▼ int.att. cm	Altezza H cm	Larghezza L cm	Peso M Kg	Volume V dm³	VERSIONI MISTE con Resistenza e *	
			Δt 50K watt	Δt 40K watt	Δt 30K watt						Watt	€
FXV	63-120	1312,00	827	626	435	117	63	120	23,5	7,1	900	107,50
FXH	130-45	1030,50	643	487	338	41	130	45	18,2	6,0	650	99,80
FXH	130-54	1096,60	770	583	405	50	130	54	21,8	6,8	800	104,20
FXH	180-45	1137,30	887	671	466	41	180	45	25,1	8,1	900	107,50
FXH	180-54	1239,00	1061	803	558	50	180	54	30,0	9,2	-	-
FXLH	180-54	1487,50	1453	1100	767	50	180	54	43,8	13,4	1500	125,40
FXH	180-63	1339,60	1233	933	648	59	180	63	34,9	10,3	1200	115,20
FXLH	180-63	1605,30	1723	1304	910	59	180	63	51,2	15,6	1500	125,40
FXH	180-72	1437,50	1407	1065	743	68	180	72	41,4	12,7	1500	125,40
FXLH	180-72	1722,80	1996	1511	1054	68	180	72	58,5	17,9	-	-
FXH	200-54	1292,20	1178	892	622	50	200	54	34,4	10,6	1200	115,20
FXH	200-63	1397,10	1369	1036	723	59	200	63	40,1	12,3	1500	125,40
FXLH	200-63	1713,70	1916	1450	1042	59	200	63	56,8	17,3	-	-
FXH	200-72	1500,00	1562	1182	825	68	200	72	45,9	14,1	1500	125,40
FXLH	200-72	1839,30	2219	1680	1172	68	200	72	64,9	19,8	-	-

\* Aggiungere: Valvola mista o TR p.207  
Termostati p.208-209

SI CONSIGLIANO I COLORI SABLÉ  
(poichè rendono la piega più morbida al tatto)

### ESECUZIONI DI SERIE

Colore bianco sablé SB9016 mensole bianche  
Tolleranze ± 3mm - Valvola di sfianto ø 1/8"  
PRESSIONE MASSIMA D'ESERCIZIO 4 BAR

### ESECUZIONI A RICHIESTA

Verniciatura in una tinta della tabella colori  
Brem con fissaggi colorati +15/25%  
Versione elettrica, a richiesta

### ATTACCHI DI SERIE

EG ø 3/8"  
A richiesta ø 1/2"  
Attacchi remoti e speciali, p.279



INTERASSE ATTACCHI EG 3/8" DI SERIE  
A richiesta EG ø 1/2" senza supplemento.

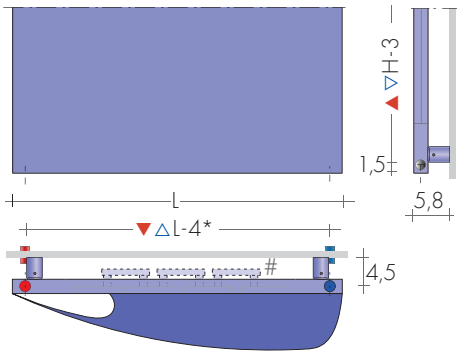

\*Mod. FXV ▲▼ L-3 # Mod. FXLH con  
\*Mod. FXH ▲▼ L-4 tubi radianti sul retro

A richiesta ATTACCHI LATERALI AC/BD 3/8"  
Attacchi ø 1/2" con manicotti  
Supplemento per AC/BD Art. AS 81,40€

Mod. FXV 63-120 ▲▼ AC/BD H - 4 cm  
Mod. FXH /FXLH ... ▲▼ AC/BD H - 3 cm



Attacchi ø 3/8"  
DI SERIE  
(a filo piastra)



Attacchi ø 1/2"  
A RICHIESTA  
(con manicotti)

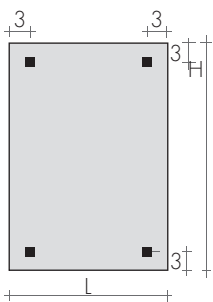

FISSAGGI B35  
Mensole comprese



FXV 63-120

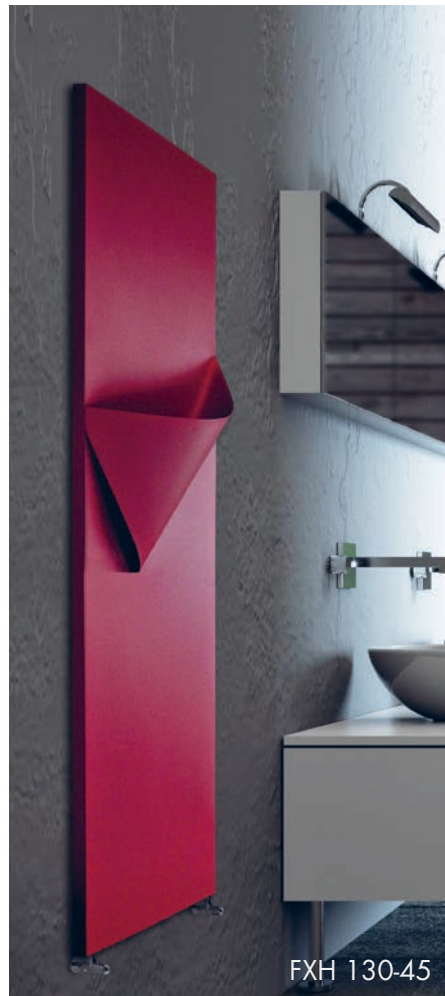

FXH 130-45



FXH 180-54

## VALVOLE CONSIGLIATE

KIT VALVOLE CROMATE comprende:

- n°2 Valvole con codoli
- n°2 Raccordi (per multistrato ø16 e rame ø12 e 14)
- n°2 Rosette tonde cromo ø 48, foro ø16

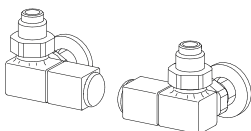

KIT VALVOLE QUADRA comando LATERALE  
pag. 271 Art. KQL 177,10€  
Colore tabella BREM supplemento 49,50€

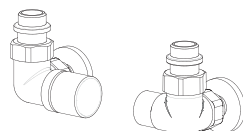

KIT VALVOLE CYL termostattabile con comando  
LATERALE, pag.273 Art. KCL 150,50€  
Colore tabella BREM supplemento 49,50€

ATTACCHI REMOTI Art. REM 37,60€  
Interasse attacchi sul retro: ▲▼ L - 5 cm  
Valvole REMOTE pag. 274

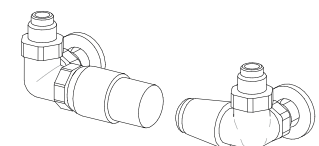
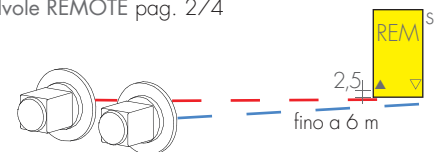

KIT VALVOLE TON comando LATERALE con testa  
TERMOSTATICA, pag. 269 Art. KTL 188,60€

Ecco la superficie scaldante senza fratture di sorta: una vera unica piastra, una forma

essenziale ed elegante per ambientazioni di ogni stile. SPH-PLATT indica un modo diver-

so di usare il calore per essere protagonisti, originali e decorativi.

## DIMENSIONI

Larghezze: da 28 a 84 cm

Altezze: da 160 a 240 cm (ogni 20 cm)

Profondità: SPH 3,7 cm, SPLH 6,2 cm

Sporgenza dal muro: SPH 6,8 cm, SPLH 7,8 cm

MODELLO SPH  
piastra verticale

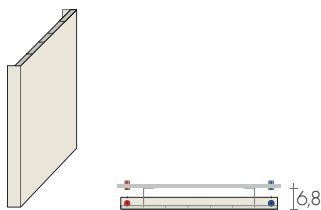

SPH

MODELLO SPLH  
piastra verticale con  
lamelle radianti sul retro

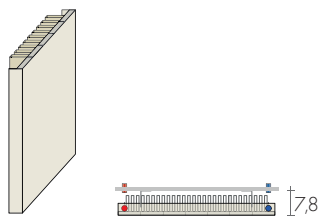

SPLH



SPH ... SPLH ...



SPH

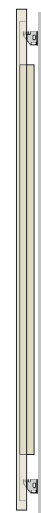

SPLH

EN 442 Watt  $\Delta t$  50K ( $\Delta t$  40K =  $W \times 0,755$ ) ( $\Delta t$  30K =  $W \times 0,526$ )

MODELLO	L cm	28	35	42	49	56	63	70	77	84
H cm	i.a	24	31	38	45	52	59	66	73	80
SPH 160	€	680,50 420w	749,60 525w	822,20 630w	896,00 735w	967,10 840w	1037,40 945w	1110,90 1050w	1182,30 1155w	1254,40 1260w
SPLH 160	€	887,00 629w	979,10 786w	1071,40 943w	1164,80 1100w	1259,20 1257w	1351,50 1414w	1445,70 1572w	1537,70 1729w	1631,50 1886w
SPH 180	€	723,30 467w	798,70 584w	873,50 701w	951,50 817w	1028,50 934w	1102,90 1051w	1181,00 1168w	1256,60 1284w	1333,70 1401w
SPLH 180	€	934,10 689w	1029,70 861w	1116,60 1033w	1222,80 1205w	1319,20 1377w	1415,00 1549w	1511,70 1721w	1608,30 1893w	1702,60 2065w
SPH 200	€	762,50 513w	842,00 642w	922,80 770w	998,80 898w	1078,90 1026w	1157,80 1155w	1237,00 1283w	1318,30 1411w	1397,30 1540w
SPLH 200	€	1002,50 742w	1107,30 928w	1210,40 1113w	1322,40 1299w	1418,60 1484w	1522,00 1670w	1625,50 1855w	1727,60 2041w	1830,90 2226w
SPH 220	€	808,70 557w	892,20 697w	976,70 836w	1072,10 976w	1148,10 1115w	1232,50 1254w	1315,10 1394w	1401,60 1533w	1487,10 1673w
SPLH 220	€	1042,40 802w	1151,60 1003w	1259,00 1204w	1375,50 1404w	1475,60 1605w	1582,80 1806w	1690,50 2006w	1796,70 2207w	1904,30 2407w
SPH 240	€	867,00 601w	958,10 751w	1049,20 901w	1140,20 1051w	1231,10 1201w	1322,50 1351w	1413,40 1502w	1506,80 1652w	1599,00 1802w

Esecuzioni con misure mod. SUIT a richiesta

$\Delta t$  diversi da 50K: consultare Dati tecnici Brem

## ORDINE

Indicare: modello se semplice o con lamelle, altezza e larghezza; in cm; attacco e colore  
es.: SPH 180 - 35, AC  $\varnothing$  1/2", BR 0007

ACCESSORI MAGNETICI pag. 277

## ESECUZIONI DI SERIE

Colore bianco sablé SB9016, mensola EOS  
Valvola di sfiato  $\varnothing$  1/8" - Tolleranze  $\pm$  3mm  
PRESSIONE MASSIMA D'ESERCIZIO 6 BAR

## ESECUZIONI A RICHIESTA

Verniciatura tabella colori Brem +15/25%  
SPLATT INOX, piastra anteriore in acciaio inox  
satinato a preventivo

## ATTACCHI DI SERIE

EG  $\varnothing$  1/2"  
Attacchi AC o BD con supplemento  
Attacchi speciali, pag. 278

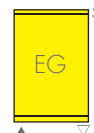

INTERASSE ALLACCIAMENTI

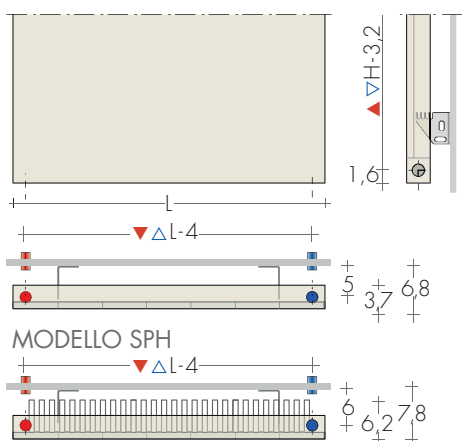

MODELLO SPLH

A richiesta attacchi laterali  
Supplemento Art. AS 81,40€

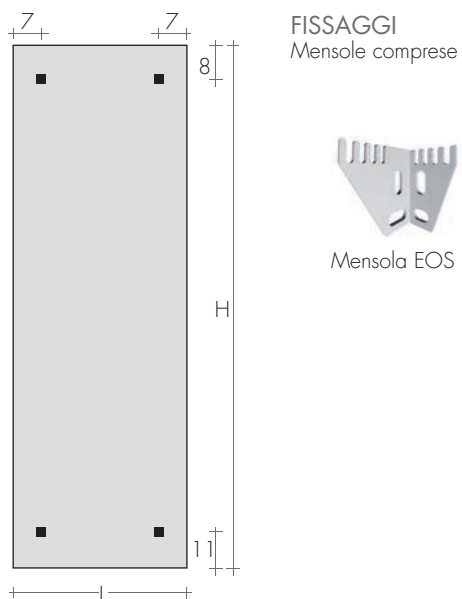

FISSAGGI  
Mensole comprese



SPH 200-49

VALVOLE CONSIGLIATE

KIT VALVOLE CROMATE comprende:

- n°2 Valvole con codoli
- n°2 Raccordi (per multistrato ø16 e rame ø12 e 14)
- n°2 Rosette tonde cromo ø 48, foro ø16

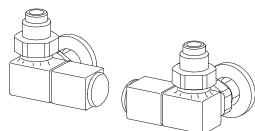

KIT VALVOLE QUADRA comando LATERALE  
pag. 271 Art. KQL 177,10€  
Colore tabella BREM supplemento 49,50€

FINITURE SPECIALI pag. 267  
Finiture Oro, Bronzo, Nickel spazzolato per 2 valvole  
KIT Raccordi NICKEL spazz. suppl. Art. RN 28,20€

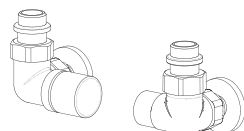

KIT VALVOLE CYL termostattabile con comando LATERALE, pag.273 Art. KCL 150,50€  
Colore tabella BREM supplemento 49,50€

ATTACCHI REMOTI Art. REM 37,60€  
Interasse attacchi sul retro: ▲▽ L - 5 cm  
Valvole REMOTE pag. 274

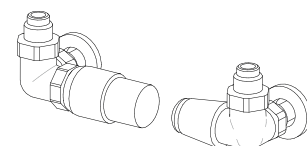

KIT VALVOLE TON comando LATERALE con testa TERMOSTATICA, pag. 269 Art. KTL 188,60€

La piastra radiante SP-PLATT, superficie piana, pura e senza fratture estetiche, è utilizzabile

anche per il posizionamento orizzontale. SPV-Platt è un validissimo supporto quando

si vuole riscaldare grandi spazi e arredare mimetizzando la fonte di calore.



SPV



SPLV

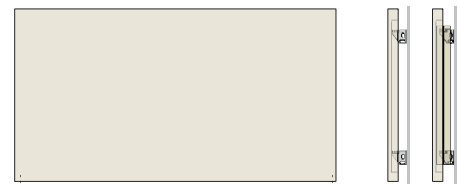

SPV ... SPLV ...

SPV SPLV

MODELLO	L cm	50	60	70	80	90	100	110	120	140	160	180	200	220	
H cm	i.a. ▲▽	cm	46,8	56,8	66,8	76,8	86,8	96,8	106,8	116,8	136,8	156,8	176,8	196,8	216,8
SPV 35	€	629,50 178w	653,60 213w	675,60 249w	697,40 284w	718,60 320w	743,50 355w	766,30 391w	788,20 426w	830,20 497w	870,90 568w	896,90 639w	923,50 710w	951,20 781w	
SPLV 35/35	€	782,10 367w	812,10 440w	843,40 513w	877,00 586w	907,20 660w	941,00 733w	972,70 806w	1003,10 880w	1063,40 1026w	1123,30 1173w	1159,00 1319w	1194,50 1466w	1230,70 1613w	
SPV 42	€	668,10 217w	695,00 260w	716,10 304w	740,30 347w	765,90 391w	791,40 434w	813,30 477w	840,70 521w	888,80 608w	945,10 694w	971,70 781w	998,70 868w	1028,30 955w	
SPLV 42/28	€	819,00 380w	853,00 456w	886,00 532w	918,40 608w	954,20 684w	987,60 760w	1021,50 836w	1056,60 912w	1123,10 1064w	1195,30 1216w	1232,90 1368w	1270,20 1520w	1307,90 1672w	
SPLV 42/42	€	829,80 417w	869,10 500w	903,30 584w	937,70 667w	975,60 751w	1008,80 834w	1045,70 917w	1083,20 1001w	1151,30 1168w	1229,00 1334w	1267,70 1501w	1306,00 1668w	1346,00 1835w	
SPV 49	€	702,90 246w	730,60 295w	758,30 344w	786,50 394w	814,00 443w	841,90 492w	869,90 541w	898,60 590w	954,50 689w	1019,70 787w	1051,10 886w	1082,40 984w	1113,50 1083w	
SPLV 49/28	€	853,30 412w	891,50 494w	928,60 576w	964,60 658w	1003,50 741w	1040,30 823w	1076,60 905w	1115,20 988w	1189,40 1152w	1272,00 1317w	1313,00 1481w	1354,00 1646w	1394,20 1811w	
SPLV 49/49	€	881,30 466w	924,70 559w	963,70 652w	1003,30 745w	1046,20 838w	1084,30 931w	1126,20 1024w	1167,90 1117w	1246,50 1303w	1333,70 1490w	1376,70 1676w	1419,50 1862w	1463,40 2048w	
SPV 56	€	745,20 276w	776,70 331w	806,50 386w	837,70 441w	870,30 496w	902,20 551w	933,60 606w	965,40 661w	1026,70 771w	1094,80 882w	1128,80 992w	1162,70 1102w	1195,70 1212w	
SPLV 56/28	€	893,90 444w	937,50 533w	976,50 622w	1018,30 710w	1056,80 799w	1097,50 888w	1140,20 977w	1180,00 1066w	1259,80 1243w	1347,60 1421w	1389,90 1598w	1432,20 1776w	1474,20 1954w	
SPLV 56/56	€	932,40 511w	980,40 613w	1024,10 715w	1069,00 818w	1116,80 920w	1159,70 1022w	1206,70 1124w	1252,50 1226w	1341,60 1431w	1438,30 1635w	1485,80 1840w	1533,20 2044w	1580,70 2249w	
SPV 63	€	785,00 305w	822,40 366w	858,70 427w	894,20 488w	930,60 549w	965,80 610w	1002,20 671w	1038,20 732w	1105,20 854w	1177,50 976w	1213,90 1098w	1250,20 1220w	1285,10 1342w	
SPLV 63/35	€	937,80 501w	983,40 601w	1027,10 701w	1073,50 801w	1116,80 901w	1163,30 1001w	1207,50 1101w	1255,20 1201w	1339,30 1401w	1431,00 1602w	1475,60 1802w	1519,90 2002w	1564,00 2202w	
SPLV 63/63	€	974,50 557w	1026,30 668w	1073,70 779w	1123,90 890w	1172,90 1002w	1224,50 1113w	1275,10 1224w	1324,40 1336w	1419,80 1558w	1519,20 1781w	1569,60 2003w	1619,70 2226w	1669,40 2449w	
SPV 70	€	856,00 326w	894,30 391w	934,70 456w	971,90 521w	1013,40 586w	1049,80 651w	1090,10 716w	1130,70 781w	1202,10 911w	1282,90 1042w	1322,10 1172w	1361,30 1302w	1400,60 1432w	
SPLV 70/35	€	1006,30 532w	1054,00 638w	1102,70 744w	1152,10 850w	1200,80 957w	1246,20 1063w	1294,80 1169w	1343,30 1276w	1434,40 1488w	1532,90 1701w	1582,00 1913w	1631,10 2126w	1679,00 2339w	
SPLV 70/70	€	1042,10 598w	1094,70 718w	1147,30 837w	1199,90 957w	1253,50 1076w	1306,30 1196w	1360,00 1316w	1412,70 1435w	1512,80 1674w	1622,70 1914w	1675,80 2153w	1729,10 2392w	1781,30 2631w	
SPV 77	€	914,20 365w	955,80 437w	995,20 510w	1036,60 583w	1077,90 656w	1117,40 729w	1159,70 802w	1198,80 875w	1275,80 1021w	1362,30 1166w	1403,40 1312w	1445,00 1458w	1486,60 1604w	
SPLV 77/35	€	1065,00 562w	1115,20 674w	1165,00 787w	1215,80 899w	1264,10 1012w	1316,70 1124w	1367,70 1236w	1417,30 1349w	1511,90 1574w	1616,70 1798w	1666,50 2023w	1716,40 2248w	1768,50 2473w	
SPLV 77/70	€	1100,40 624w	1157,10 749w	1212,00 874w	1266,40 998w	1321,20 1123w	1376,90 1248w	1431,40 1373w	1486,10 1498w	1591,50 1747w	1704,50 1997w	1759,10 2246w	1814,30 2496w	1869,70 2746w	
SPV 84	€	976,20 394w	1020,80 472w	1064,40 551w	1108,70 630w	1151,20 708w	1194,70 787w	1239,00 866w	1283,80 944w	1368,30 1102w	1455,90 1259w	1501,30 1417w	1546,90 1574w	1590,50 1732w	
SPLV 84/35	€	1126,90 590w	1179,60 708w	1233,00 826w	1285,70 944w	1339,50 1062w	1392,30 1180w	1444,00 1298w	1496,50 1416w	1600,10 1652w	1708,20 1888w	1762,30 2124w	1816,20 2360w	1869,70 2596w	
SPLV 84/70	€	1164,70 652w	1222,50 782w	1280,20 912w	1337,10 1042w	1214,10 1173w	1453,60 1303w	1511,20 1433w	1568,70 1564w	1682,50 1824w	1799,00 2085w	1857,00 2345w	1915,00 2606w	1974,10 2867w	
SPV 91	€	1022,20 424w	1070,50 509w	1118,70 594w	1167,90 678w	1214,10 763w	1262,10 848w	1313,70 933w	1360,60 1018w	1452,30 1187w	1547,00 1357w	1594,10 1526w	1641,60 1696w	1688,00 1866w	

Esecuzioni con misure mod. SUIT a richiesta

Δt diversi da 50K: consultare Dati tecnici Brem

ESECUZIONI DI SERIE

Colore bianco sablé SB9016, mensola EOS  
Valvola di sfiato ø 1/8" - Tolleranze ± 3mm  
PRESSIONE MASSIMA D'ESERCIZIO 6 BAR

ESECUZIONI A RICHIESTA

Verniciatura tabella colori Brem +15/25%  
SPLATT INOX, piastra anteriore in acciaio inox satinato a preventivo

ATTACCHI DI SERIE

EG ø 1/2"  
Attacchi AC o BD (supplemento)  
Attacchi speciali, pag. 278



INTERASSE ALLACCIAMENTI

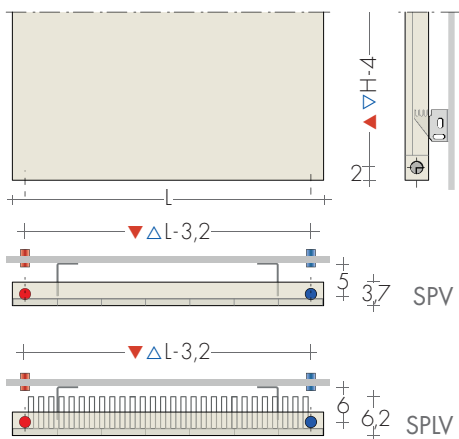

A richiesta attacchi laterali  
Supplemento Art. AS 81,40€

FISSAGGI  
Mensole comprese

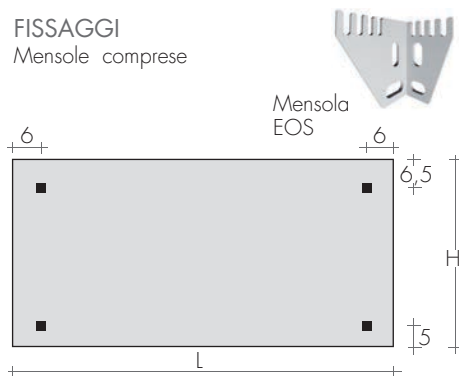

ORDINE

Indicare: modello se semplice o con lamelle, altezza e larghezza in cm; attacco e colore es.: SPLV 49/49-180, EG ø1/2", BR 0004 Altezza 49/altezza lamelle 49/Larg. 180cm

VALVOLE CONSIGLIATE

KIT VALVOLE CROMATE comprende:

- n°2 Valvole con codoli
- n°2 Raccordi (per multistrato ø16 e rame ø12 e 14)
- n°2 Rosette tonde cromo ø 48, foro ø16

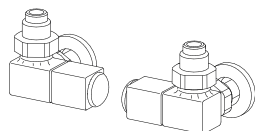

KIT VALVOLE QUADRA comando LATERALE  
pag. 271 Art. KQL 177,10€  
Colore tabella BREM supplemento 49,50€

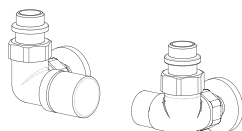

KIT VALVOLE CYL termostatzabile con comando LATERALE, pag.273 Art. KCL 150,50€  
Colore tabella BREM supplemento 49,50€

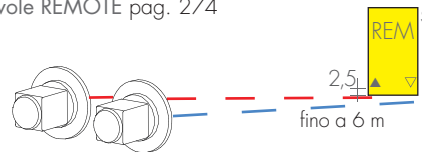

FINITURE SPECIALI pag. 267  
Finiture Oro, Bronzo, Nickel spazzolato per 2 valvole  
KIT Raccordi NICKEL spazz. suppl.Art. RN 28,20€

ATTACCHI REMOTI Art. REM 37,60€  
Interasse attacchi sul retro: ▲▼ L - 3,2 cm  
Valvole REMOTE pag. 274



SUIT-H nasce dai tubi piatti, che formano un tutt'uno con i collettori, assemblati in modo

da costruire una superficie radiante completamente piana, ritmata dall'unione dei vari

elementi. Può essere costruita semplice o doppia e con l'inserimento di lamelle sul retro.

SUIT-H..  
con tubi piatti verticali

H = da 60 a 220 cm  
(ogni 20 cm)

L = da 14 a 98 cm  
(da 1 a 14 elementi)

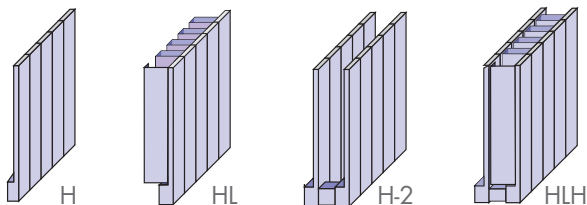

## INTERASSE ALLACCIAMENTI

Di serie attacchi EG verticali  
A richiesta attacchi laterali, senza supplemento

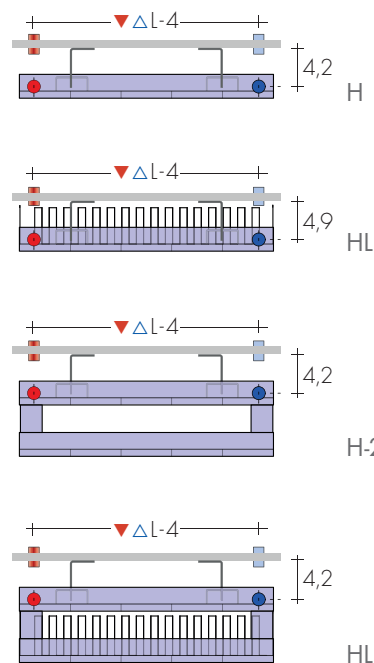
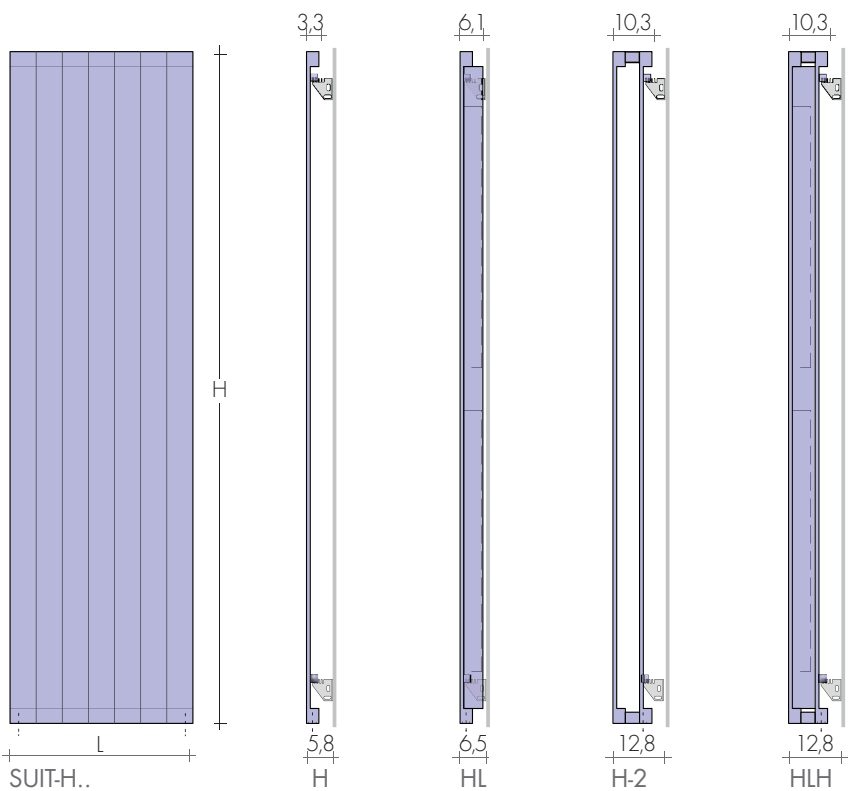
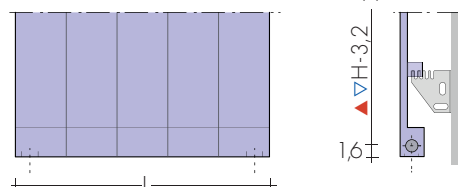

Bandelle laterali di serie per piastre con lamelle

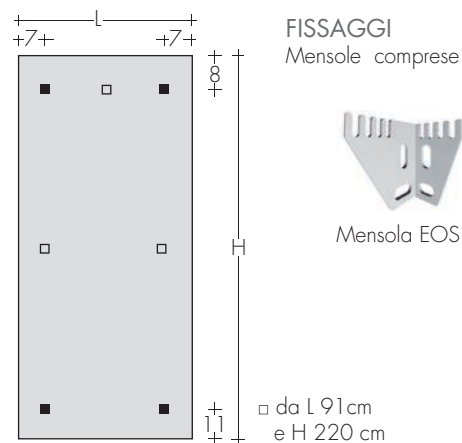

FISSAGGI  
Mensole comprese

Mensola EOS

SUIT-H c/lamelle    piastra sul retro    altezza tubi cm    larghezza cm  
HLH 180 - 49

### ORDINE

Indicare: il modello (L indica la lamellatura) con altezza e lunghezza in cm; l'allacciamento e il colore se diversi dall'esecuzione di serie es.: HL 180 - 49, AC  $\varnothing$  1/2", RAL 3005

### ALTEZZE A RICHIESTA:

H, HL, H-2, HLH: 120, 140, 150 cm

H, H-2: 240, 300 cm

- Altezze ogni 10 cm: interpolare rese e prezzi

- Altezze ogni 1 cm: interpolare rese; prezzi:

misura superiore + 20%

Larghezze fino 1,4m: interpellare ufficio tecnico

### ESECUZIONI DI SERIE

Colore bianco sablé SB9016 fissaggi EOS  
Valvola di sfiato  $\varnothing$  1/8" - Tolleranze  $\pm$  3mm  
Pressione massima d'esercizio 6 BAR

### ESECUZIONI A RICHIESTA

Verniciatura tabella colori Brem fino a 3 mt  
(oltre richiedere fattibilità) +15/25%

### ATTACCHI DI SERIE

EG  $\varnothing$  1/2"  $\blacktriangle$  L-4 cm  
A richiesta attacchi AC o BD e speciali, pag. 278



MODELLO	L cm	14	21	28	35	42	49	56	63	70	77	84	91	98
H cm	(n° el)	(2)	(3)	(4)	(5)	(6)	(7)	(8)	(9)	(10)	(11)	(12)	(13)	(14)
i.a. ▲ ▽		10	17	24	31	38	45	52	59	66	73	80	87	94
H60	€	162,90 85w	197,10 127w	232,40 170w	267,80 212w	301,10 255w	337,30 297w	372,60 339w	407,20 382w	442,10 424w	476,60 467w	511,50 509w	546,10 551w	581,30 594w
HL60	€	277,70 138w	316,30 207w	353,60 276w	391,10 345w	427,20 415w	465,50 484w	504,10 553w	541,20 622w	578,70 691w	616,10 760w	653,80 829w	691,30 898w	728,80 967w
H60-2	€	461,00 141w	530,30 211w	600,00 282w	669,70 352w	739,60 423w	809,20 493w	876,60 564w	948,20 634w	1017,80 705w	1087,00 775w	1156,70 846w	1226,50 916w	1295,90 987w
HLH60	€	602,20 197w	666,50 296w	731,40 394w	796,20 493w	861,50 591w	927,20 690w	990,80 788w	1056,70 887w	1121,50 986w	1186,50 1084w	1251,30 1183w	1316,40 1281w	1365,30 1380w
H80	€	190,20 111w	230,30 166w	268,80 221w	311,40 277w	351,20 332w	388,70 388w	429,30 443w	469,90 498w	508,00 554w	548,50 609w	588,70 665w	628,20 720w	668,20 775w
HL80	€	279,80 177w	320,10 265w	360,70 354w	408,20 442w	454,30 531w	503,10 619w	547,40 708w	593,90 796w	640,50 885w	688,10 973w	733,20 1062w	779,50 1150w	825,90 1239w
H80-2	€	492,00 179w	569,70 269w	649,50 359w	729,30 448w	809,20 538w	887,10 628w	966,80 717w	1046,50 807w	1126,40 897w	1203,70 986w	1284,30 1076w	1363,40 1166w	1443,00 1255w
HLH80	€	604,50 246w	670,00 368w	739,60 491w	821,10 614w	903,00 737w	985,00 859w	1066,80 982w	1148,60 1105w	1230,50 1228w	1312,10 1350w	1393,80 1473w	1475,50 1596w	1557,40 1719w
H100	€	205,00 137w	249,40 205w	293,10 273w	337,30 341w	382,20 410w	427,20 478w	469,90 546w	514,10 614w	559,50 683w	602,20 751w	648,60 819w	691,70 887w	737,60 956w
HL100	€	298,80 214w	351,20 320w	401,10 427w	452,90 534w	504,10 641w	555,70 747w	607,10 854w	657,40 961w	709,20 1068w	760,40 1174w	813,20 1281w	865,80 1388w	916,00 1495w
H100-2	€	524,20 217w	612,30 325w	700,00 434w	787,60 542w	876,60 651w	964,80 759w	1052,70 867w	1140,60 976w	1230,50 1084w	1318,30 1193w	1405,70 1301w	1494,90 1410w	1582,80 1518w
HLH100	€	612,30 299w	701,90 448w	792,00 598w	882,00 747w	970,60 896w	1060,50 1046w	1150,50 1195w	1240,60 1344w	1330,40 1494w	1419,10 1643w	1437,10 1793w	1599,30 1942w	1688,90 2091w
H160	€	256,50 210w	314,10 315w	372,60 420w	427,20 525w	485,20 630w	543,50 735w	600,00 840w	655,80 945w	714,10 1050w	770,60 1155w	828,20 1260w	887,10 1365w	941,50 1470w
HL160	€	399,00 314w	475,90 471w	553,60 629w	629,40 786w	705,20 943w	781,80 1100w	859,50 1257w	935,40 1414w	1013,30 1572w	1088,90 1729w	1165,60 1886w	1241,20 2043w	1317,50 2200w
H160-2	€	622,00 326w	731,40 488w	843,60 651w	955,70 814w	1066,80 977w	1176,90 1139w	1287,90 1302w	1400,00 1465w	1511,10 1628w	1621,20 1790w	1732,50 1953w	1844,70 2116w	1955,50 2279w
HLH160	€	747,60 431w	877,90 646w	1008,80 862w	1138,70 1077w	1269,60 1293w	1400,00 1508w	1531,60 1724w	1660,70 1939w	1792,80 2155w	1924,20 2370w	2053,50 2586w	2185,90 2801w	2315,10 3017w
H180	€	290,30 234w	356,60 350w	422,80 467w	487,60 584w	551,60 701w	619,00 817w	684,70 934w	748,90 1051w	815,70 1168w	880,80 1284w	947,40 1401w	1013,30 1518w	1077,40 1635w
HL180	€	450,90 344w	537,70 516w	620,90 689w	705,50 861w	791,40 1033w	876,60 1205w	962,10 1377w	1046,60 1549w	1132,40 1721w	1217,90 1893w	1301,70 2065w	1387,30 2237w	1471,70 2410w
H180-2	€	676,20 360w	802,00 540w	926,60 720w	1052,10 900w	1176,60 1079w	1302,30 1259w	1427,10 1439w	1553,10 1619w	1677,70 1799w	1803,20 1979w	1926,90 2159w	2053,60 2339w	2177,40 2518w
HLH180	€	844,90 474w	992,50 711w	1142,30 949w	1289,70 1186w	1437,80 1423w	1556,10 1660w	1732,80 1897w	1880,10 2134w	2029,90 2372w	2178,20 2609w	2325,40 2846w	2473,10 3083w	2620,30 3320w
H200	€	304,60 257w	374,00 385w	442,30 513w	510,50 642w	580,90 770w	646,10 898w	715,10 1026w	783,50 1155w	851,80 1283w	922,30 1411w	990,30 1540w	1060,00 1668w	1127,90 1796w
HL200	€	474,70 371w	565,80 557w	657,90 742w	746,40 928w	838,80 1113w	929,70 1299w	1022,20 1484w	1112,60 1670w	1203,70 1855w	1295,00 2041w	1387,30 2226w	1479,50 2412w	1570,40 2597w
H200-2	€	731,40 393w	870,20 590w	1007,70 787w	1146,40 984w	1285,00 1180w	1423,10 1377w	1561,60 1574w	1700,30 1770w	1837,90 1967w	1976,50 2164w	2115,30 2361w	2253,00 2557w	2391,60 2754w
HLH200	€	879,00 515w	1037,40 772w	1195,40 1030w	1354,80 1287w	1513,20 1544w	1671,00 1802w	1829,60 2059w	1989,40 2317w	2147,70 2574w	2306,30 2832w	2464,20 3089w	2622,40 3346w	2781,00 3604w
H220	€	318,60 279w	394,40 418w	468,30 557w	540,60 697w	614,30 836w	689,00 976w	764,00 1115w	837,70 1254w	909,40 1394w	985,40 1533w	1060,00 1673w	1132,40 1812w	1205,20 1951w
HL220	€	497,50 401w	593,90 602w	689,00 802w	787,20 1003w	883,20 1204w	978,70 1404w	1077,40 1605w	1173,60 1806w	1271,50 2006w	1365,40 2207w	1462,00 2407w	1559,50 2608w	1654,60 2809w
H220-2	€	768,50 426w	915,80 639w	1065,10 851w	1215,00 1064w	1362,30 1277w	1513,20 1490w	1662,60 1703w	1809,60 1916w	1959,30 2129w	2108,60 2342w	2257,30 2555w	2406,90 2768w	2556,40 2980w
HLH220	€	953,70 555w	1127,10 832w	1300,60 1110w	1473,80 1387w	1649,40 1665w	1822,70 1942w	1996,20 2220w	2169,60 2497w	2342,90 2775w	2515,00 3052w	2688,60 3330w	2862,10 3607w	3035,10 3885w

Δt diversi da 50 K: consultare Dati tecnici Brem

## VALVOLE CONSIGLIATE

KIT VALVOLE CROMATE comprende:

- n°2 Valvole con codali
- n°2 Raccordi (per multistrato ø16 e rame ø12 e 14)
- n°2 Rosette tonde cromo ø 48, foro ø16

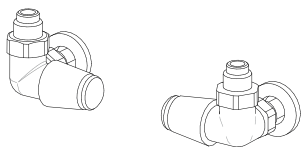

KIT VALVOLE TON comando LATERALE  
pag.269 Art. KVL 139,20€

FINITURE SPECIALI

Finiture Oro, Bronzo, Nickel spazzolato per 2 valvole

KIT Raccordi NICKEL spazz. suppl.Art. RN 28,20€

KIT VALVOLE CYL termostattabile con comando  
LATERALE, pag.273 Art. KCL 150,50€  
Colore tabella BREM supplemento 49,50€

pag. 267

ATTACCHI REMOTI Art. REM 37,60€

Interasse attacchi sul retro: ▲ ▽ L - 5 cm

Valvole REMOTE pag. 274

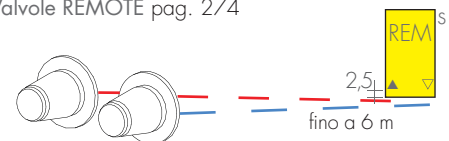

KIT VALVOLE TON comando LATERALE con testa  
TERMOSTATICA, pag. 269 Art. KTL 188,60€

La caratteristica dei tubi piatti assemblati, dove il collettore ed i tubi piatti sono acco-

stati fra loro perfettamente integrati in un solo piano, la si ritrova in SUIT-V. Qui la piastra è

prevista in orizzontale e può essere realizzata semplice o doppia e con lamelle sul retro.

MODELLO SUIT-V.  
con tubi piatti orizzontali

H = da 28 a 140 cm  
(ogni 7 cm)

L = da 50 a 240 cm  
(ogni 10 cm)

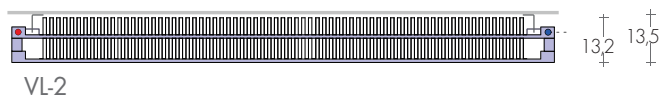
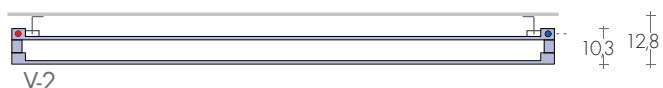
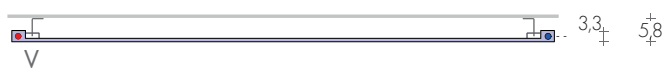
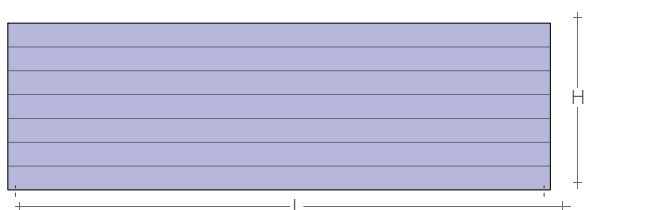
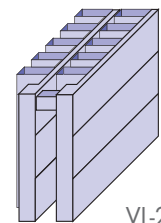
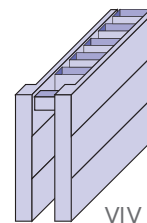
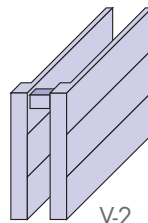
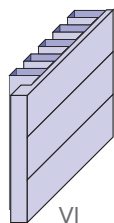
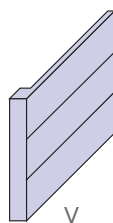

## INTERASSE ALLACCIAMENTI

Di serie attacchi EG verticali  
A richiesta attacchi laterali, senza supplemento

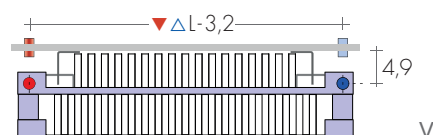
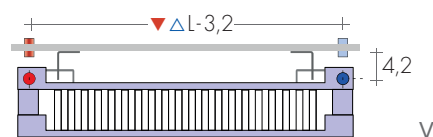
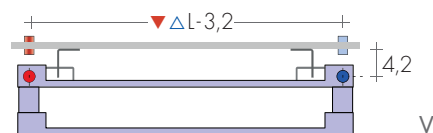
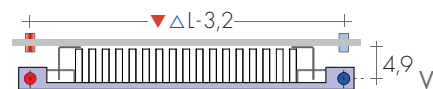
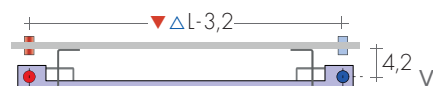
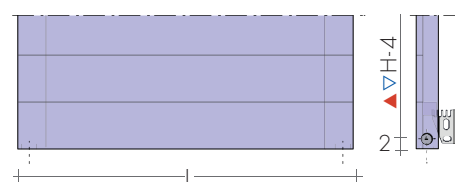

## ORDINE

Indicare: il modello (L indica la lamellatura) con altezza e altezza lamelle, lunghezza in cm; l'allacciamento e il colore  
es.: VL 42/28-180, AC ø 1/2", BR 0002

Mensola EOS

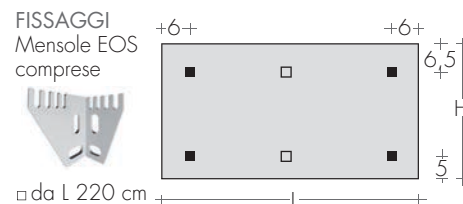

## ESECUZIONI DI SERIE

Colore bianco sablé SB9016 fissaggi EOS  
Valvola di sfiato ø 1/8" - Tolleranze ± 3mm  
Pressione massima d'esercizio 6 BAR

## ESECUZIONI A RICHIESTA

Verniciatura tabella colori Brem fino a 3 mt  
(oltre richiedere fattibilità) +15/25%

## ATTACCHI DI SERIE

EG ø 1/2" ▲▽ L-3,2 cm  
A richiesta attacchi AC o BD  
Attacchi speciali, pag. 278





SUIT H 180 - 49

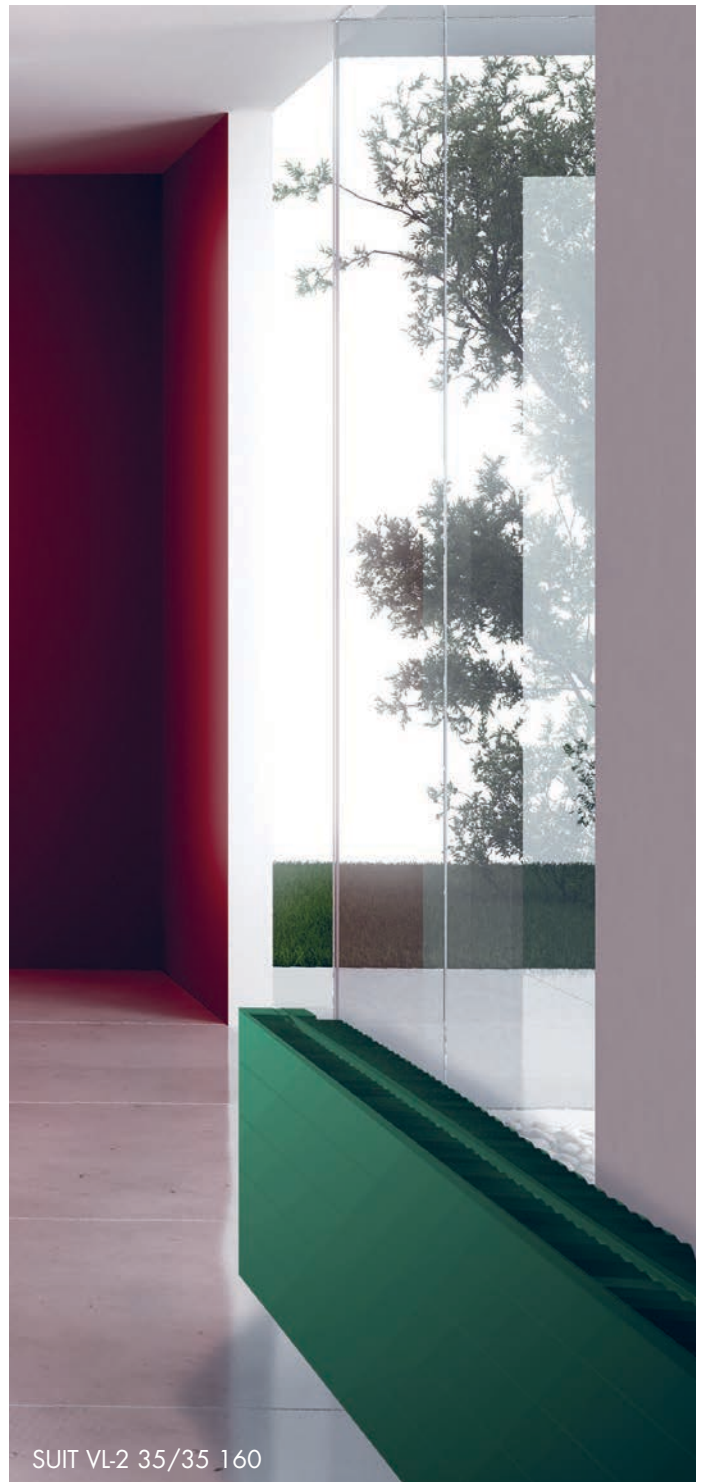

SUIT VL-2 35/35 160

## VALVOLE CONSIGLIATE

KIT VALVOLE CROMATE comprende:

- n°2 Valvole con codoli
- n°2 Raccordi (per multistrato ø16 e rame ø12 e 14)
- n°2 Rosette tonde cromo ø 48, foro ø16



KIT VALVOLE TON comando LATERALE pag.269

Art. KVL 139,20€

## FINITURE SPECIALI

Finiture Oro, Bronzo, Nickel spazzolato per 2 valvole  
KIT Raccordi NICKEL spazz. suppl.Art. RN 28,20€

pag. 267

KIT VALVOLE CYL termostattabile con comando LATERALE, pag.273 Art. KCL 150,50€  
Colore tabella BREM supplemento 49,50€

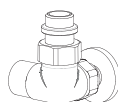
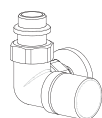

## ATTACCHI REMOTI

Interasse attacchi sul retro: ▲ ▽ L - 5 cm

Valvole REMOTE pag. 274

Art. REM 37,60€

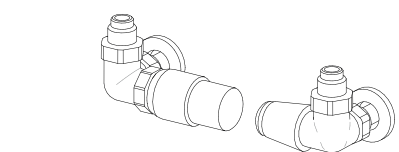
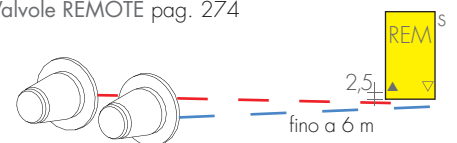

KIT VALVOLE TON comando LATERALE con testa TERMOSTATICA, pag. 269 Art. KTL 188,60€

MODELLO	L cm Hcm	EN 442 Watt $\Delta t$ 50K ( $\Delta t$ 40K = Wx0,755) - ( $\Delta t$ 30K = Wx0,526)													
		50 ▲▽cm46,8	60 56,8	70 66,8	80 76,8	90 86,8	100 96,8	110 106,8	120 116,8	140 136,8	160 156,8	180 176,8	200 196,8	220 216,8	240 236,8
V28	€	249,40 144w	262,70 173w	275,90 202w	289,00 230w	301,10 259w	316,30 288w	330,50 317w	341,40 346w	367,60 403w	394,20 461w	418,10 518w	446,60 576w	471,80 634w	499,20 691w
VL28/28	€	362,80 314w	384,80 377w	409,40 440w	430,20 502w	452,90 565w	474,70 628w	496,90 691w	518,10 754w	564,80 879w	608,00 1005w	651,70 1130w	697,90 1256w	741,50 1382w	785,90 1507w
V28-2	€	623,30 256w	650,60 307w	676,80 358w	703,30 409w	728,40 460w	754,70 511w	780,80 562w	805,10 613w	859,50 715w	910,10 818w	960,90 920w	1015,40 1022w	1065,20 1124w	1118,10 1226w
V35	€	277,10 178w	293,10 213w	308,40 249w	322,60 284w	337,30 320w	354,70 355w	369,60 391w	384,80 426w	415,10 497w	444,50 568w	475,90 639w	506,00 710w	536,10 781w	567,70 852w
VL35/35	€	391,10 367w	415,10 440w	439,40 513w	463,90 586w	489,10 660w	511,90 733w	536,10 806w	562,80 880w	611,20 1026w	657,40 1173w	707,10 1319w	756,20 1466w	805,10 1613w	853,50 1759w
V35-2	€	678,80 308w	712,20 370w	741,50 431w	770,60 493w	801,90 554w	832,50 616w	863,70 678w	893,00 739w	954,60 862w	1015,40 986w	1076,60 1109w	1137,40 1232w	1199,10 1355w	1257,90 1478w
VLV35/35	€	792,00 501w	831,30 601w	871,80 701w	911,30 802w	951,30 902w	988,80 1002w	1029,30 1102w	1068,50 1202w	1148,60 1403w	1228,30 1603w	1308,10 1804w	1388,00 2004w	1465,70 2204w	1545,40 2405w
VL35/35-2	€	905,00 681w	955,70 817w	1003,00 953w	1052,70 1090w	1100,90 1226w	1148,60 1362w	1197,90 1498w	1246,50 1634w	1343,60 1907w	1441,40 2179w	1539,60 2452w	1635,50 2724w	1732,50 2996w	1830,50 3269w
V42	€	308,40 217w	324,20 260w	341,40 304w	358,70 347w	375,80 391w	394,20 434w	408,20 477w	425,30 521w	461,00 608w	492,80 694w	527,40 781w	562,80 868w	593,90 955w	629,40 1042w
VL42/28	€	420,20 380w	446,60 456w	473,70 532w	501,30 608w	525,30 684w	550,60 760w	577,00 836w	602,20 912w	655,80 1064w	707,10 1216w	759,80 1368w	811,20 1520w	863,70 1672w	914,30 1824w
VL42/42	€	425,30 417w	452,90 500w	481,80 584w	508,00 667w	536,10 751w	566,80 834w	593,90 917w	621,30 1001w	676,80 1168w	733,50 1334w	787,60 1501w	844,50 1668w	899,00 1835w	954,60 2002w
V42-2	€	741,50 362w	775,70 434w	809,20 506w	842,00 578w	875,80 651w	910,10 723w	944,50 795w	977,90 868w	1044,50 1012w	1112,20 1157w	1180,10 1302w	1248,60 1446w	1315,10 1591w	1381,60 1735w
VLV42/28	€	853,50 534w	896,90 641w	941,50 748w	982,80 854w	1027,20 961w	1068,50 1068w	1112,20 1175w	1156,50 1282w	1242,40 1495w	1328,30 1709w	1414,20 1922w	1498,90 2136w	1587,20 2350w	1673,00 2563w
VLV42/42	€	857,60 570w	903,00 683w	949,80 797w	992,90 911w	1036,20 1025w	1082,90 1139w	1128,10 1253w	1173,00 1367w	1262,80 1595w	1351,80 1822w	1441,40 2050w	1531,60 2278w	1621,20 2506w	1711,10 2734w
VL42/28-2	€	968,90 693w	1021,00 832w	1072,80 970w	1124,30 1109w	1176,90 1247w	1228,30 1386w	1283,00 1525w	1334,10 1663w	1437,10 1940w	1543,70 2218w	1647,60 2495w	1750,40 2772w	1856,60 3049w	1959,40 3326w
VL42/42-2	€	976,70 768w	1033,10 921w	1088,90 1075w	1144,50 1228w	1200,00 1382w	1256,50 1535w	1312,10 1689w	1367,80 1842w	1479,70 2149w	1590,90 2456w	1702,90 2763w	1814,40 3070w	1926,30 3377w	2037,40 3684w
V49	€	333,20 246w	353,60 295w	372,60 344w	391,10 394w	410,30 443w	429,30 492w	448,50 541w	467,70 590w	506,00 689w	545,60 787w	583,80 886w	623,30 984w	661,90 1083w	700,00 1181w
VL49/28	€	446,60 412w	473,70 494w	503,10 576w	531,40 658w	559,50 741w	589,20 823w	617,40 905w	644,30 988w	703,30 1152w	760,40 1317w	817,20 1481w	873,70 1646w	931,60 1811w	987,90 1975w
VL49/49	€	450,80 466w	481,80 559w	509,90 652w	543,50 745w	572,60 838w	602,20 931w	632,40 1024w	661,90 1117w	724,20 1303w	783,90 1490w	845,40 1676w	906,20 1862w	966,80 2048w	1027,20 2234w
V49-2	€	789,90 415w	828,20 498w	868,70 581w	908,10 664w	947,30 747w	985,00 830w	1023,20 913w	1061,60 996w	1141,50 1162w	1217,10 1328w	1293,90 1494w	1373,90 1660w	1449,70 1826w	1528,40 1992w
VLV49/28	€	903,00 585w	951,30 702w	999,00 819w	1046,50 936w	1095,00 1053w	1142,50 1170w	1189,10 1287w	1236,30 1404w	1332,60 1638w	1427,30 1872w	1523,10 2106w	1619,40 2340w	1713,20 2574w	1808,20 2808w
VLV49/49	€	907,20 636w	957,70 763w	1007,10 890w	1054,60 1017w	1105,20 1144w	1154,60 1271w	1203,70 1398w	1254,80 1525w	1351,80 1779w	1451,50 2034w	1549,70 2288w	1648,60 2542w	1748,60 2796w	1846,50 3050w
VL49/28-2	€	1017,00 746w	1072,80 895w	1130,20 1044w	1189,10 1194w	1244,60 1343w	1300,10 1492w	1357,40 1641w	1416,00 1790w	1527,20 2089w	1643,30 2387w	1754,80 2686w	1870,70 2984w	1982,10 3283w	2097,80 3581w
VL49/49-2	€	1025,30 849w	1085,00 1019w	1146,50 1189w	1206,30 1358w	1265,70 1528w	1328,30 1698w	1388,00 1868w	1447,50 2038w	1569,60 2377w	1688,90 2717w	1810,20 3056w	1930,50 3396w	2051,40 3736w	2173,70 4075w
V56	€	365,90 276w	386,90 331w	408,20 386w	429,30 441w	450,80 496w	471,80 551w	490,90 606w	511,90 661w	555,70 771w	598,00 882w	640,50 992w	682,60 1102w	726,20 1212w	768,70 1322w
VL56/28	€	479,90 444w	508,00 533w	538,80 622w	567,70 710w	598,00 799w	631,20 888w	659,60 977w	691,00 1066w	749,60 1243w	811,20 1421w	871,80 1598w	933,70 1776w	994,10 1954w	1053,80 2131w
VL56/56	€	495,20 511w	531,40 613w	566,80 715w	602,20 818w	636,60 920w	673,70 1022w	707,10 1124w	741,50 1226w	811,20 1431w	882,90 1635w	952,80 1840w	1023,20 2044w	1094,00 2249w	1164,90 2453w
V56-2	€	854,40 469w	896,90 563w	939,20 657w	982,20 750w	1025,30 844w	1067,70 938w	1108,20 1032w	1150,50 1126w	1236,30 1313w	1322,40 1501w	1407,20 1688w	1493,20 1876w	1575,80 2064w	1661,50 2251w
VLV56/28	€	966,80 637w	1019,20 764w	1070,70 891w	1122,10 1018w	1174,50 1146w	1226,50 1273w	1275,90 1400w	1328,30 1528w	1431,30 1782w	1535,30 2037w	1639,50 2291w	1742,60 2546w	1844,70 2800w	1948,60 3055w
VLV56/56	€	982,80 697w	1040,20 836w	1096,60 975w	1152,60 1115w	1208,30 1254w	1265,70 1394w	1322,40 1533w	1377,80 1672w	1491,60 1951w	1603,20 2230w	1716,40 2509w	1828,20 2788w	1942,70 3067w	2053,50 3345w
VL56/28-2	€	1080,90 800w	1140,60 959w	1202,40 1119w	1264,50 1279w	1324,50 1439w	1384,00 1599w	1445,50 1759w	1507,20 1919w	1627,20 2239w	1750,40 2558w	1870,70 2878w	1993,80 3198w	2113,00 3518w	2237,80 3838w
VL56/56-2	€	1112,20 924w	1184,80 1109w	1254,80 1294w	1324,50 1478w	1393,80 1663w	1463,80 1848w	1535,30 2033w	1604,90 2218w	1744,50 2587w	1885,80 2957w	2026,40 3326w	2165,50 3696w	2307,20 4066w	2331,20 4435w
V63	€	394,20 305w	417,30 366w	439,40 427w	463,90 488w	486,80 549w	511,90 610w	536,10 671w	559,50 732w	607,10 854w	653,60 976w	703,30 1098w	749,60 1220w	798,00 1342w	845,40 1464w
VL63/35	€	506,00 501w	538,80 601w	572,60 701w	605,30 801w	638,20 901w	671,60 1001w	703,30 1101w	737,60 1201w	803,10 1401w	868,70 1602w	935,40 1802w	1001,20 2002w	1065,20 2202w	1131,30 2402w
VL63/63	€	524,20 557w	562,80 668w	600,00 779w	636,60 890w	675,20 1002w	714,10 1113w	749,60 1224w	787,60 1336w	863,70 1558w	937,50 1781w	1015,40 2003w	1088,90 2226w	1164,90 2449w	1241,20 2671w
V63-2	€	910,10 522w	958,50 626w	1006,10 731w	1053,80 835w	1102,30 940w	1148,60 1044w	1196,20 1148w	1245,30 1253w	1338,10 1462w	1436,40 1670w	1531,60 1879w	1628,30 2088w	1721,10 2297w	1818,20 2506w
VLV63/35	€	1025,30 710w	1082,90 851w	1138,70 993w	1196,20 1135w	1252,70 1277w	1309,10 1419w	1365,90 1561w	1423,30 1703w	1537,60 1987w	1650,70 2270w	1764,60 2554w	1877,90 2838w	1991,70 3122w	2104,90 3406w
VLV63/63	€	1040,20 757w	1102,30 908w	1164,90 1059w	1226,50 1210w	1287,90 1362w	1349,40 1513w	1410,30 1664w	1471,80 1816w	1595,20 2118w	1719,40 2421w	1840,80 2723w	1963,50 3026w	2087,80 3329w	2209,20 3631w
VL63/35-2	€	1136,50 894w	1202,40 1073w	1267,70 1252w	1334,10 1430w	1400,00 1609w	1467,60 1788w	1533,50 1967w	1599,30 2146w	1731,20 2503w	1862,70 2861w	1993,80 3218w	2125,10 3576w	2259,80 3934w	2391,20 4291w
VL63/63-2	€	1173,00 995w	1246,50 1193w	1322,40 1392w	1398,00 1591w	1473,90 1790w	1547,50 1989w	1623,60 2188w	1698,80 2387w	1850,60 2785w	2000,10 3182w	2151,50 3580w	2301,30 3978w	2452,60 4376w	2604,10 4774w

EN 442 Watt  $\Delta t$  50K ( $\Delta t$  40K =  $W \times 0,755$ ) - ( $\Delta t$  30K =  $W \times 0,526$ )

MODELLO	L cm	50	60	70	80	90	100	110	120	140	160	180	200	220	240
	▲▼ cm 46,8	56,8	66,8	76,8	86,8	96,8	106,8	116,8	136,8	156,8	176,8	196,8	216,8	236,8	
V70	€	436,50	463,90	489,10	517,10	543,50	569,70	598,00	623,30	676,80	733,50	785,90	840,40	893,00	947,30
VL70/35	€	548,50	586,10	619,30	655,80	693,00	728,40	764,80	801,90	871,80	944,50	1016,40	1088,90	1160,80	1232,50
VL70/70	€	566,80	607,10	648,60	688,10	728,40	768,70	809,20	849,50	931,60	1013,30	1094,00	1177,80	1257,90	1338,10
V70-2	€	994,80	1048,40	1104,00	1158,70	1211,30	1265,70	1317,50	1371,70	1481,10	1588,10	1694,00	1803,10	1910,10	2017,60
VLV70/35	€	1110,40	1173,00	1236,30	1297,90	1361,70	1425,50	1487,60	1551,70	1676,90	1803,10	1928,50	2055,80	2182,00	2307,20
VLV70/70	€	1126,40	1194,30	1262,10	1330,40	1398,00	1465,70	1531,60	1599,30	1734,50	1870,70	2006,10	2142,40	2276,70	2413,30
VL70/35-2	€	1224,50	1295,90	1367,80	1439,60	1514,00	1582,80	1656,70	1728,40	1871,80	2018,30	2161,70	2305,30	2450,50	2593,90
VL70/70-2	€	1256,50	1338,10	1419,10	1501,20	1582,80	1662,90	1744,50	1826,50	1990,00	2153,70	2317,20	2480,70	2641,10	2805,30
V77	€	471,80	503,10	529,20	559,50	587,80	617,40	644,30	673,70	730,40	787,60	845,40	904,20	960,90	1018,10
VL77/35	€	586,10	623,30	661,90	700,00	737,60	775,70	813,20	851,90	928,30	1004,30	1079,80	1156,50	1230,50	1308,10
VL77/70	€	602,20	644,30	688,10	730,40	772,80	817,20	859,50	902,10	987,90	1072,80	1158,70	1243,60	1327,30	1412,10
V77-2	€	1069,50	1125,10	1184,20	1241,20	1297,90	1356,60	1414,20	1471,80	1588,10	1700,00	1816,40	1931,30	2045,50	2161,70
VLV77/35	€	1184,20	1250,70	1315,90	1384,00	1449,70	1517,30	1582,80	1649,60	1783,10	1916,00	2049,60	2182,80	2315,10	2448,30
VLV77/70	€	1200,00	1271,70	1342,20	1414,20	1486,10	1557,50	1627,20	1698,80	1842,40	1983,70	2127,40	2268,60	2412,10	2554,40
VL77/35-2	€	1295,90	1371,70	1447,50	1523,10	1599,30	1674,60	1752,50	1826,50	1977,70	2129,30	2281,00	2432,50	2585,90	2735,30
VL77/70-2	€	1330,40	1416,00	1498,90	1584,90	1670,40	1754,80	1840,50	1926,30	2096,20	2266,50	2436,50	2608,20	2778,00	2947,60
V84	€	508,00	541,20	572,60	602,20	634,30	666,50	697,90	730,40	792,00	856,60	918,50	982,20	1046,50	1108,20
VL84/35	€	621,30	661,90	703,30	743,50	783,90	824,00	865,80	906,20	987,90	1067,70	1148,60	1232,50	1314,10	1395,00
VL84/70	€	638,20	682,60	730,40	775,70	821,10	866,70	912,30	956,70	1048,40	1139,30	1230,50	1322,40	1412,10	1504,20
V84-2	€	1141,50	1205,00	1267,70	1331,40	1393,10	1457,80	1521,30	1582,80	1709,10	1837,20	1963,50	2087,80	2214,00	2340,30
VLV84/35	€	1256,50	1328,30	1402,00	1473,90	1545,40	1619,40	1691,20	1762,60	1908,40	2051,40	2197,10	2342,40	2486,00	2632,70
VLV84/70	€	1271,70	1349,40	1427,30	1503,10	1581,00	1658,50	1734,50	1812,10	1965,70	2119,00	2275,10	2428,30	2582,20	2737,60
VL84/35-2	€	1369,60	1451,50	1533,50	1615,10	1697,10	1778,90	1858,70	1940,30	2104,10	2266,50	2430,30	2592,50	2755,70	2919,40
VL84/70-2	€	1404,20	1493,80	1584,90	1674,60	1767,80	1858,70	1948,60	2039,30	2221,10	2403,00	2583,90	2767,80	2949,70	3130,10
V91	€	538,80	572,60	607,10	640,50	675,20	709,20	743,50	779,10	845,40	916,00	985,00	1053,80	1122,10	1189,10
V91-2	€	1199,10	1267,70	1335,30	1405,00	1474,80	1542,30	1611,40	1679,00	1818,20	1955,40	2093,90	2230,10	2366,70	2506,00
V98	€	566,80	605,30	640,50	676,80	716,30	751,40	787,60	826,20	899,00	973,60	1048,40	1123,50	1196,20	1271,70
V98-2	€	1257,90	1333,30	1407,20	1482,90	1554,20	1630,40	1704,00	1780,00	1927,10	2076,70	2224,20	2373,90	2521,50	2670,90
V112	€	638,20	678,80	722,40	762,80	805,10	847,70	887,90	931,60	1015,40	1099,00	1181,70	1267,70	1350,70	1434,40
V112-2	€	1400,90	1485,00	1568,80	1653,80	1737,30	1820,20	1904,30	1986,80	2158,80	2321,10	2490,90	2667,30	2842,40	2993,00
V126	€	707,10	754,70	801,90	847,70	894,90	941,50	989,80	1036,20	1129,40	1224,50	1317,50	1412,10	1505,90	1599,30
V126-2	€	1540,50	1634,60	1727,50	1822,40	1915,30	2010,30	2104,10	2198,00	2384,90	2573,80	2761,40	2949,70	3137,30	3325,20
V140	€	772,80	826,20	877,90	931,60	982,20	1036,20	1088,90	1141,50	1245,30	1350,70	1455,60	1561,50	1666,90	1771,80
V140-2	€	1673,00	1778,00	1882,00	1986,80	2092,10	2198,00	2303,10	2406,10	2617,20	2826,60	3037,20	3246,40	3455,60	3668,10

 $\Delta t$  diversi da 50 K: consultare Dati tecnici Brem

V piastra orizzontale

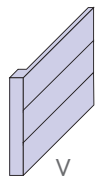

VL piastra con lamelle

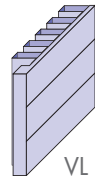

V-2 piastra doppia

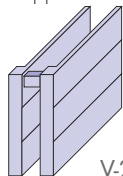

VLV piastra doppia con lamelle

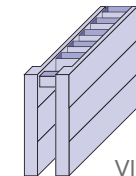

VL-2 piastra doppia con doppie lamelle

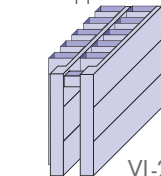

# CAMEO

## SCALDASALVIETTE & CALORIFERI

PREZZI DAL 01.03.2026 +5%

design Davide Diliberto

Forma elementare, al tempo stesso decorativa e versatile, che può inserirsi con discrezione

in ambienti diversi. È uno strumento in più a disposizione dell'architetto per poter dare

al proprio progetto un tocco romantico, friendly o moderno a seconda del colore.

### DIMENSIONI

Larghezza: 54 cm

Altezze: 104/134/184/214 cm

Profondità: 2,3 / 8,3 cm

Sporgenza dal muro: 5,8 / 11,8 cm

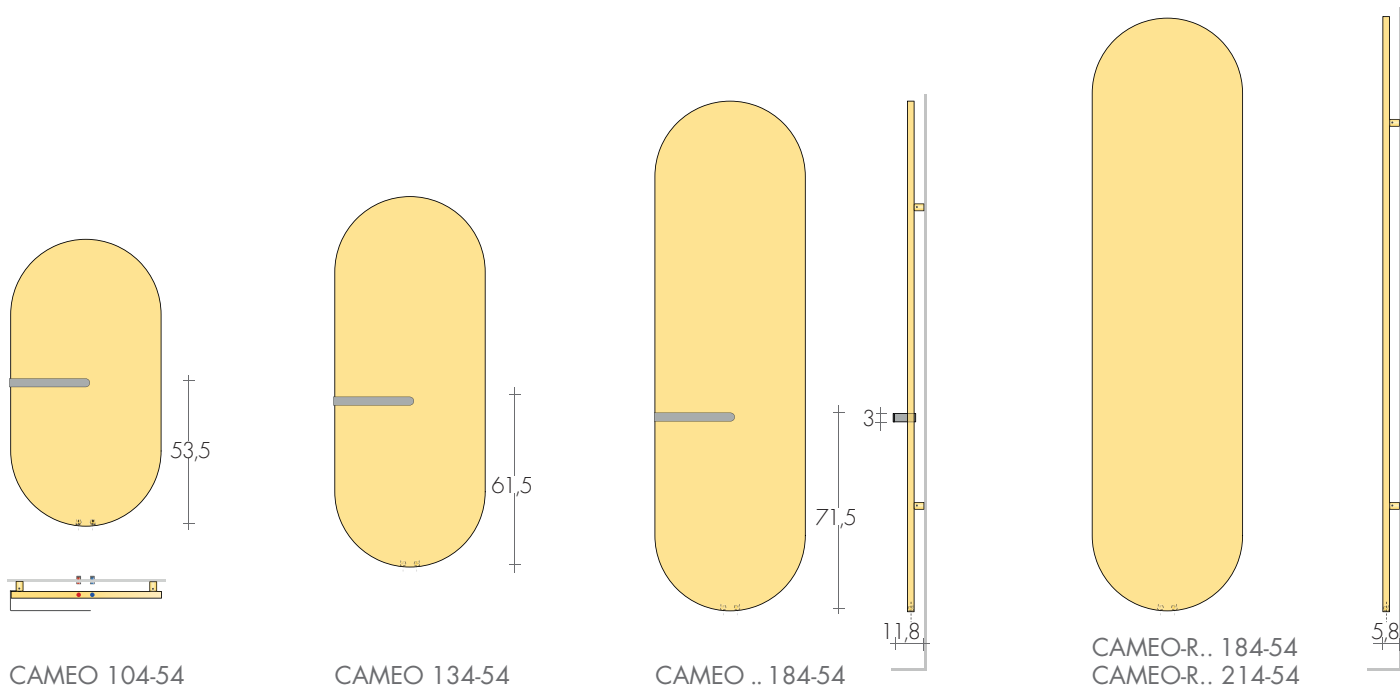

CAMEO 104-54

CAMEO 134-54

CAMEO .. 184-54

CAMEO-R.. 184-54  
CAMEO-R.. 214-54

MODELLO'25	HxL cm	Biancodi serie sablé SB9016 €	EN 442			▲▼ int.att. cm	Altezza H cm	Larghezza L cm	Peso M Kg	Volume V dm³	VERSIONI MISTE con Resistenza e *	
			Δt50K watt	Δt40K watt	Δt30K watt						Watt	€
CAMEO	104-54	936,90	500	379	263	5	104	54	15,8	6,9	500	97,80
CAMEO	134-54	1044,90	672	509	353	5	134	54	21,1	9,2	650	99,80
CAMEO	184-54	1198,60	958	725	504	5	184	54	30,0	13,2	900	107,50
CAMEO-L	184-54	1415,90	1300	984	684	5	184	54	40,8	16,5	1200	115,20
Modelli senza maniglione - caloriferi												
CAMEO-R	184-54	1144,20	958	725	504	5	184	54	30,0	13,2	900	107,50
CAMEO-RL	184-54	1361,50	1300	984	684	5	184	54	40,8	16,5	1200	115,20
CAMEO-R	214-54	1234,10	1129	856	594	5	214	54	35,4	15,5	1200	115,20
CAMEO-RL	214-54	1627,40	1585	1201	834	5	214	54	49,8	19,8	1500	125,40

Su richiesta maniglione a destra senza supplemento

\* Aggiungere: Valvola mista o TR p.207  
Termostati p.208-209

Maniglione CAMEO supplementare o a detrarre  
Art. MCA 54,40€

MANIGLIONE CAMEO: COLORI DI SERIE  
- bianco sablé SB 9016 - grigio sablé SB 7039  
- nero sablé SB 9005 - nel colore del radiatore

In un colore della tabella Brem diverso dalla piastra  
scaldasalviette Supplemento 49,00€

ACCESSORI MAGNETICI pag. 277



### ESECUZIONI DI SERIE

Colore bianco sablé SB 9016, mensola B35  
Tolleranze ± 3mm - Valvola di sfianto ø 1/8"  
PRESSIONE MASSIMA D'ESERCIZIO 4 BAR

### ESECUZIONI A RICHIESTA

Verniciatura in una tinta della tabella colori  
Brem con fissaggi colorati +15/25%  
Versione elettrica e.Cameo, pag. 212

### ATTACCHI DI SERIE EG ø 3/8"

A richiesta, senza supplemento,  
attacchi EG ø 1/2"  
con manicotti sporgenti 2 cm



**INTERASSE ATTACCHI EG  $\varnothing$  3/8"**  
 Attacchi con manicotti integrati

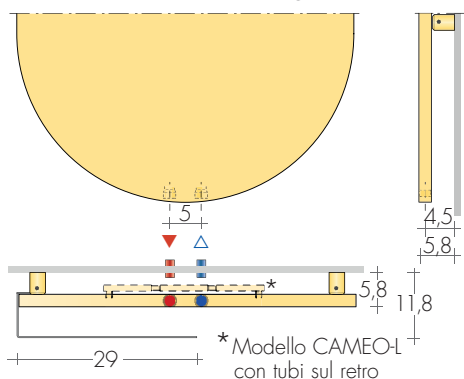

**INTERASSE ATTACCHI EG  $\varnothing$  1/2"**  
 Attacchi con manicotti sporgenti

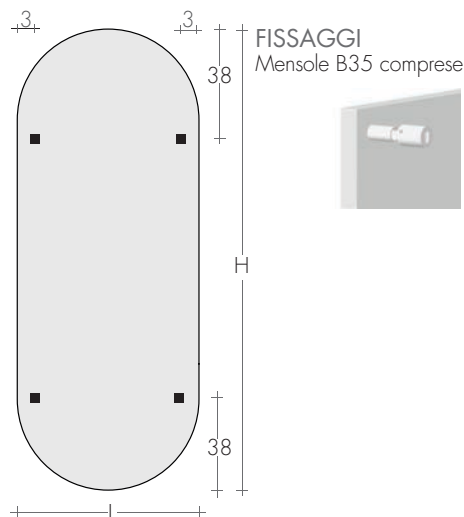
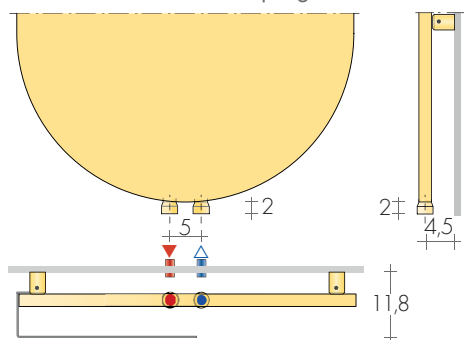

PIASTRE

**VALVOLE CONSIGLIATE**

KIT VALVOLE CROMATE comprende:

- n°2 Valvole con codoli
- n°2 Raccordi (per multistrato  $\varnothing$ 16 e rame  $\varnothing$ 12 e 14)
- n°2 Rosette tonde cromo  $\varnothing$  48, foro  $\varnothing$ 16

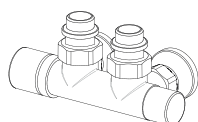

KIT valvola CYL BITUBO SX TERMOSTATIZZABILE  
 ▲▼ 5 cm, pag. 273 Art. KCB 158,80€  
 Colore tabella BREM supplemento 49,50€

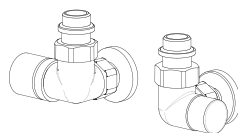

KIT VALVOLE CYL termostattizzabile comando  
 LATERALE, pag.273 Art. KCLD 150,50€  
 Colore tabella BREM supplemento 49,50€

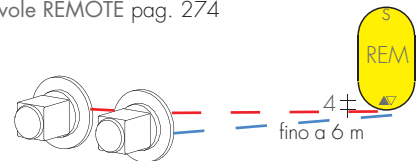

ATTACCHI REMOTI Art. REM 37,60€  
 Interasse attacchi sul retro: ▲▼ 5 cm  
 Valvole REMOTE pag. 274

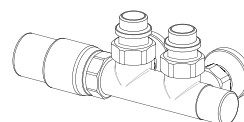

KIT valvola BITUBO SX con testa TERMOSTATICA  
 ▲▼ 5 cm, pag. 274 Art. KTB 186,60€  
 Colori e finiture speciali pag.266-267

design Luigi Brembilla

Clark è composto da una piastra radiante in acciaio ultrasottile, di soli 2,3 cm di spessore, tagliata trasversalmente in modo asimmetrico da un maniglione rettangolare riscaldante.

Questo, può essere verniciato in un colore della tabella Brem, diverso dalla piastra.

## DIMENSIONI

L: larghezza piastra 36 / 45 cm  
 L': larghezza maniglione 64/84/104/124 cm  
 Altezze 80/130 / 180 cm  
 Profondità 9 cm  
 Sporgenza dal muro 12 cm

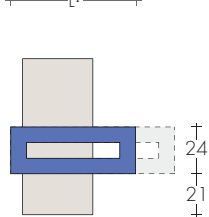
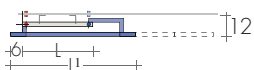

CLARK 80-36/...

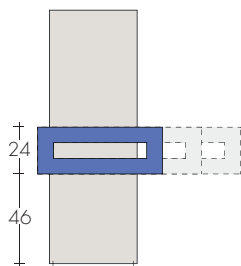

CLARK 130-45/...

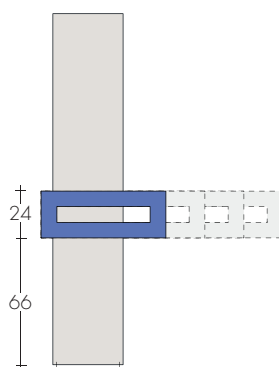

CLARK 180-36/...

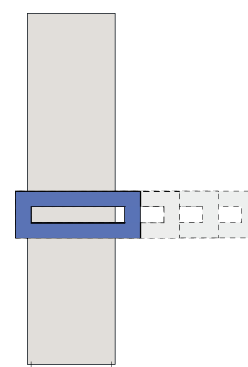

CLARK 180-45/...

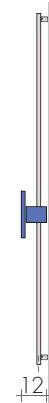

MODELLO	H/L/L' cm	Bianco di serie sablé SB 9016 €	EN 442			▲▼ int.att. cm	Altezza H cm	Larghezza L/L' cm	Peso M Kg	Volume V dm <sup>3</sup>	VERSIONI MISTE con Resistenza e *	
			Δt 50K watt	Δt 40K watt	Δt 30K watt						Resistenza Watt	€
CLARK	80-36/64	984,30	479	366	252	32	80	36/64	12,2	5,2	500	97,80
CLARK	80-45/84	1101,00	601	459	316	41	80	45/84	15,2	6,2	650	99,80
CLARK	130-36/64	1100,90	676	512	356	32	130	36/64	17,8	7,1	650	99,80
CLARK	130-36/84	1128,30	720	545	379	32	130	36/84	18,7	7,6	650	99,80
CLARK	130-36/104	1159,10	764	578	402	32	130	36/104	19,5	8,1	650	99,80
CLARK	130-45/64	1218,10	801	606	421	41	130	45/64	21,2	7,9	800	104,20
CLARK	130-45/84	1246,50	845	640	444	41	130	45/84	22,1	8,4	800	104,20
CLARK	130-45/104	1278,30	889	673	468	41	130	45/104	22,9	8,9	900	107,50
CLARK	180-36/64	1278,20	872	660	459	32	180	36/64	23,4	8,9	900	107,50
CLARK	180-36/84	1306,50	916	693	482	32	180	36/84	24,3	9,4	900	107,50
CLARK	180-36/104	1338,00	960	727	505	32	180	36/104	25,1	9,9	900	107,50
CLARK	180-36/124	1381,50	1004	760	528	32	180	36/124	25,9	10,5	900	107,50
CLARK	180-45/64	1363,50	1045	791	550	41	180	45/64	28,1	10,0	900	107,50
CLARK	180-45/84	1392,00	1089	824	573	41	180	45/84	29,0	10,5	1200	115,20
CLARK	180-45/104	1423,90	1133	858	596	41	180	45/104	29,8	11,0	1200	115,20
CLARK	180-45/124	1466,90	1177	891	619	41	180	45/124	30,6	11,6	1200	115,20

Supplemento per il maniglione in un colore BREM diverso dal radiatore Art. CMC 66,50€

\* Aggiungere: Valvola mista o TR p.207  
 Termostati p.208-209

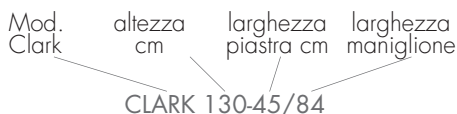

ACCESSORI MAGNETICI pag. 277

## ESECUZIONI DI SERIE

Colore bianco sablé SB9016 fissaggi B35  
 Tolleranze ± 3mm - Valvola di sfianto ø 1/8"  
 PRESSIONE MASSIMA D'ESERCIZIO 4 BAR

## ESECUZIONI A RICHIESTA

Verniciatura in una tinta della tabella colori  
 Brem con fissaggi colorati +15/25%  
 Maniglione verso sinistra senza supplemento

## ATTACCHI DI SERIE

EG ø 3/8"  
 Attacchi speciali, pag.278  
 Versione elettrica, eClark p. 217



INTERASSE ATTACCHI EG 3/8" verticali

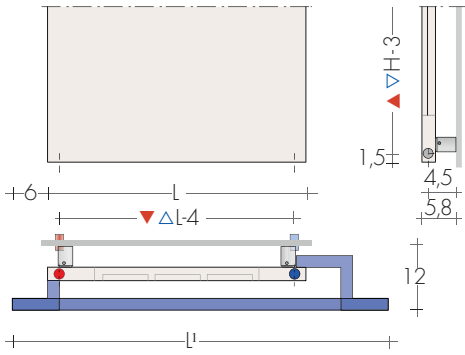

A richiesta attacchi laterali 3/8"  
Supplemento Art. AS 81,40€



Attacchi ø 3/8"  
DI SERIE  
(a filo piastra)



Attacchi ø 1/2"  
A RICHIESTA  
(con manicotti)

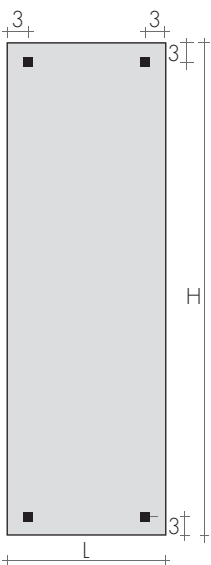

FISSAGGI  
Mensole comprese



Mensola B35



CLARK 180-45/104

VALVOLE CONSIGLIATE

KIT VALVOLE CROMATE comprende:

- n°2 Valvole con codoli
- n°2 Raccordi (per multistrato ø16 e rame ø12 e 14)
- n°2 Rosette tonde cromo ø 48, foro ø16

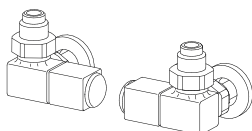

KIT VALVOLE QUADRA comando LATERALE  
pag. 271 Art. KQL 177,10€  
Colore tabella BREM supplemento 49,50€

FINITURE SPECIALI

pag. 267  
Finiture Oro, Bronzo, Nickel spazzolato per 2 valvole  
KIT Raccordi NICKEL spazz. suppl. Art. RN 28,20€

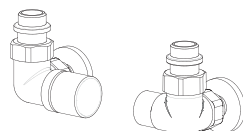

KIT VALVOLE CYL termostattabile con comando  
LATERALE, pag.273 Art. KCL 150,50€  
Colore tabella BREM supplemento 49,50€

ATTACCHI REMOTI Art. REM 37,60€

Interasse attacchi sul retro: ▲ ▽ L - 5 cm

Valvole REMOTE pag. 274

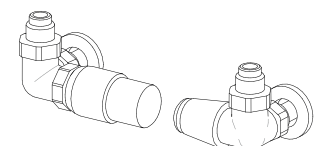
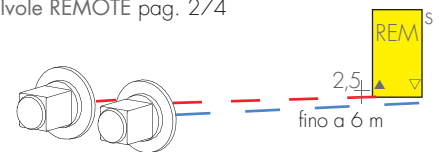

KIT VALVOLE TON comando LATERALE con testa  
TERMOSTATICA, pag.269 Art. KTL 188,60€

design Luigi Brembilla

Scaldasalviette realizzato con la piastra lamina di soli 22 mm di spessore esterno

e dal particolare bordo rastremato su cui è montata una struttura portasalviette costruita

in filo quadrato di soli 6 mm di lato dall'estetica minimalista.

## DIMENSIONI

Larghezze: 44/49/54 cm

Altezze: 80,5/96,5/124,5/148,5/152,5/168,5/180,5 cm

Profondità: 11 cm

Sporgenza dal muro: 14 cm

CUBICO-2 con struttura portasalviette doppia

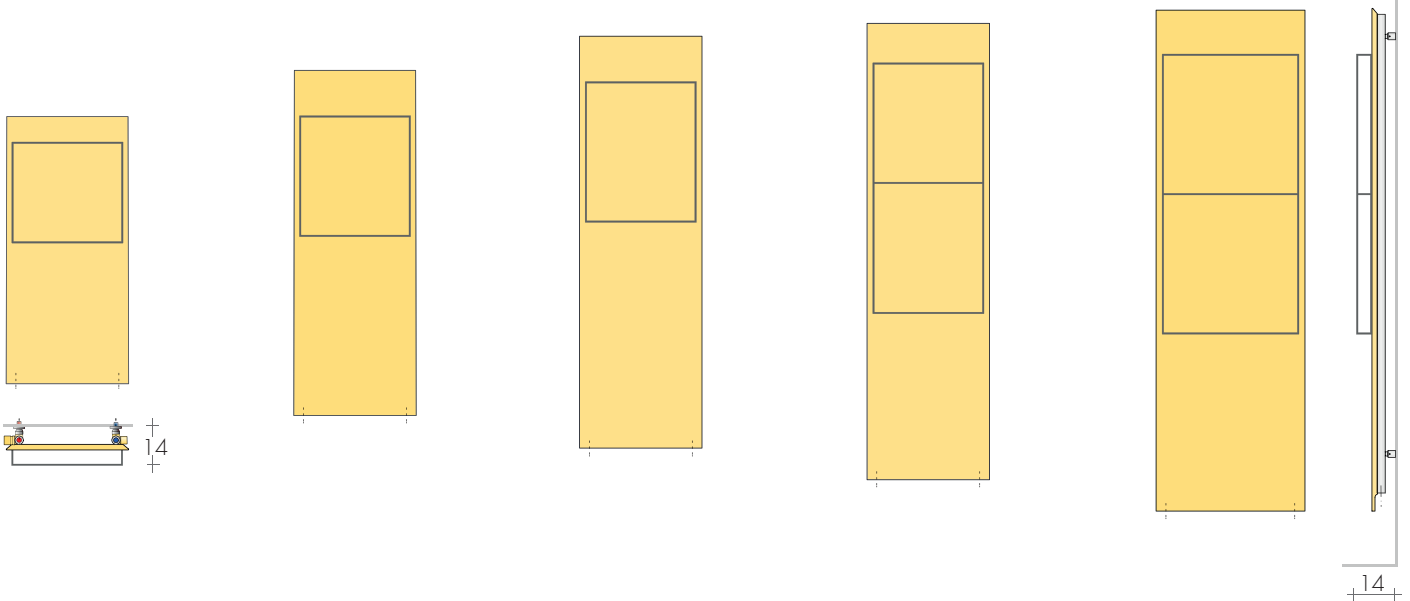

CUBICO 80-44  
CUBICO 96-44

CUBICO 124-44

CUBICO 148-44  
CUBICO 168-44

CUBICO-2 168-44

CUBICO-2 152-49  
CUBICO-2 180-54

## MODELLO'25

	HxL cm	Bianco di serie sablé SB9016 €	Δt 50K watt	EN 442 Δt 40K watt	Δt 30K watt	▲▼ int.att. cm	Altezza H cm	Largh. L cm	Peso M Kg	Volume V dm³	VERSIONI MISTE con Resistenza e * Watt	€
CUBICO	80-44	632,80	409	309	215	35	80,5	44	10,5	3,1	400	95,70
CUBICO	96-44	701,00	500	378	263	35	96,5	44	12,7	3,8	500	97,80
CUBICO	124-44	776,90	659	498	347	35	124,5	44	16,6	5,1	650	99,80
CUBICO	148-44	843,10	796	601	419	35	148,5	44	19,8	6,1	800	104,20
CUBICO	168-44	898,60	909	686	478	35	168,5	44	22,7	7,0	900	107,50
CUBICO-2	168-44	928,60	909	686	478	35	168,5	44	23,1	7,0	900	107,50
CUBICO-2	152-49	916,30	901	680	474	40	152,5	49	23,0	6,9	900	107,50
CUBICO-2	180-54	1081,70	1175	887	618	45	180,5	54	29,5	8,9	1200	115,20

\* Aggiungere: Valvola mista p.207  
Termostati p.208-209

## PORTA-SALVIETTE CUB: COLORI DI SERIE

- bianco sablé SB 9016 - grigio sablé SB 7039  
- nero sablé SB 9005 - nel colore del radiatore

In un colore della tabella Brem diverso dalla piastra scaldasalviette Supplemento 49,00€



## ESECUZIONI DI SERIE

Colore bianco SB9016 fissaggi bianchi G30  
Tolleranze ± 3mm - Valvola di sfianto ø 1/8"  
PRESSIONE MASSIMA D'ESERCIZIO 6 BAR

## ESECUZIONI A RICHIESTA

Verniciatura tabella colori Brem  
fissaggi colorati  
Versione elettrica, e.Cubico p. 223

+15/25%

## ATTACCHI DI SERIE

EG ø 1/2"

Attacchi speciali, pag.278

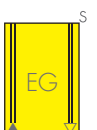

INTERASSE ATTACCHI

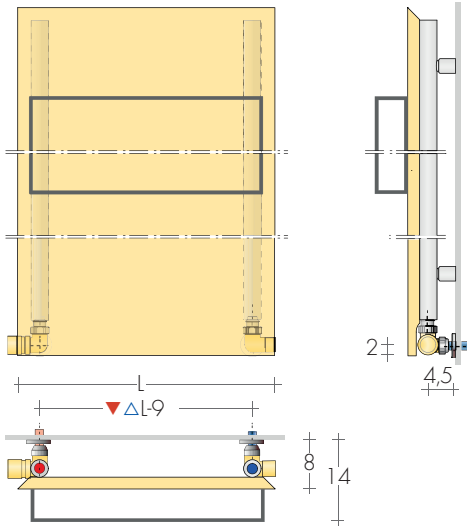

VERSIONI MISTE

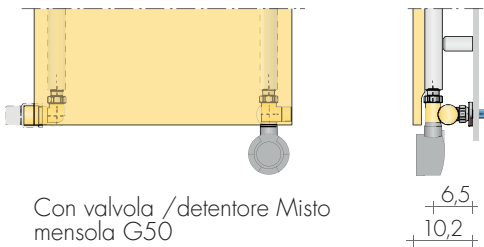

Con valvola /detettore Misto mensola G50

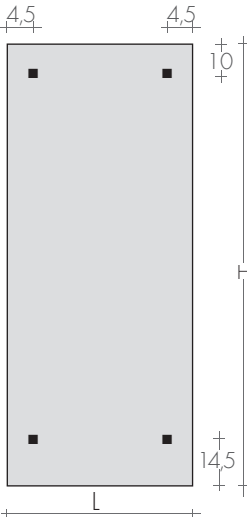

FISSAGGI Mensola G30 comprese



CUBICO-2 152-49

VALVOLE CONSIGLIATE

KIT VALVOLE CROMATE comprende:

- n°2 Valvole con codali
- n°2 Raccordi (per multistrato ø16 e rame ø12 e 14)
- n°2 Rosette tonde cromo ø 48, foro ø16

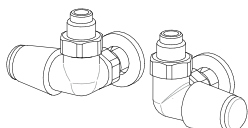

KIT VALVOLE TON comando LATERALE nichelate volantino cromo Art. KVLN 97,00€

KIT VALVOLE TON comando LATERALE cromo pag.269 Art. KVL 139,20€

FINITURE SPECIALI

pag. 267  
Finiture Oro, Bronzo, Nickel spazzolato per 2 valvole  
KIT Raccordi NICKEL spazz. suppl.Art. RN 28,20€

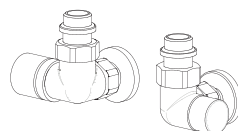

KIT VALVOLE CYL termostattizzabile comando LATERALE, pag.273 Art. KCLD 150,50€  
Colore tabella BREM supplemento 49,50€

COLORAZIONE BICOLOR:

BIC10 Cover della piastra in colore Brem a scelta con collettori e retro bianco sablé SB 9016 +10%  
BIC20 Cover in colore Brem a scelta con collettori e retro sablé nero SB9005 o grigio sablé SB7039+20%  
BIC35 N° 2 colori Brem a scelta +35%

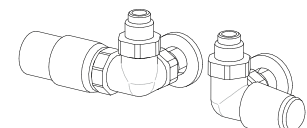

KIT VALVOLE TON comando LATERALE nichelate testa TERMOSTATICA, Art. KTLND 143,80€

KIT VALVOLE TON comando LATERALE con testa TERMOSTATICA, pag.269 Art. KTLD 188,60€

design Luigi Brembilla

DUO è uno scaldasalviette composto da due piastre radianti quadrate sovrapposte

a due collettori tondi. Lo spessore minimal delle piastre, il loro profilo rastremato e le

valvole nascoste, donano alla collezione un carattere di leggerezza ed eleganza.

## DIMENSIONI

Larghezze: 44/49/54/59 cm

Altezze: 100,5/116,5/124,5/132,5 cm

Profondità: 5,2 cm

Sporgenza dal muro: 8,2 cm

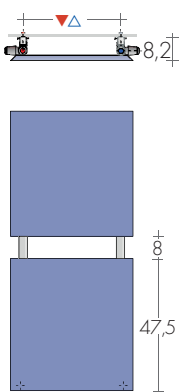

DUO 101-44

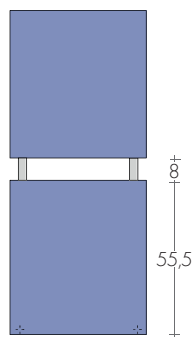

DUO 117-49

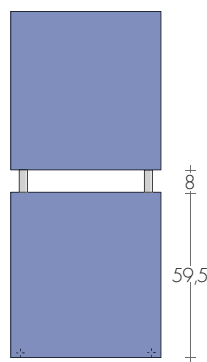

DUO 125-54

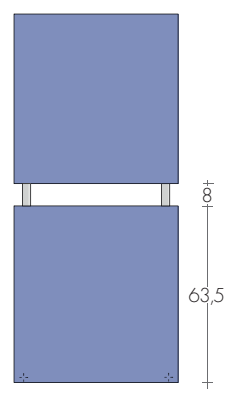

DUO 133-59

MODELLO	HL cm	Bianco di serie sablé SB9016 €	EN 442			▲ ▽ int.att. cm	Altezza H cm	Larghezza L cm	Peso M Kg	Volume V dm³	VERSIONI MISTE con resistenza *	
			Δt 50K watt	Δt 40K watt	Δt 30K watt						W	€
DUO	101-44	612,40	486	367	256	35	100,5	44	12,5	3,8	500	97,80
DUO	117-49	732,30	634	479	333	40	116,5	49	16,3	4,9	650	99,80
DUO	125-54	784,40	747	564	393	45	124,4	54	19,1	5,7	800	104,20
DUO	133-59	820,30	868	655	457	50	132,5	59	22,2	6,5	900	107,50

\* Aggiungere: Valvola mista p.207  
Termostati p.208-209

## COLORAZIONE BICOLOR:

BIC10 Cover della piastra in colore Brem a scelta con collettori e retro bianco sablé SB 9016 +10%  
BIC20 Cover in colore Brem a scelta con collettori e retro sablé nero SB9005 o grigio sablé SB7039+20%  
BIC35 N° 2 colori Brem a scelta +35%

## ESECUZIONI DI SERIE

Colore bianco sablé SB9016 mensole bianche  
Tolleranze ± 3mm - Valvola di sfianto ø 1/8"  
PRESSIONE MASSIMA D'ESERCIZIO 6 BAR

## ESECUZIONI A RICHIESTA

Verniciatura tabella colori Brem  
mensole verniciate  
Versione elettrica, eDuo p. 224

+15/25%

## ATTACCHI DI SERIE

EG ø 1/2"

Utilizzare valvole comando laterale



INTERASSE ATTACCHI

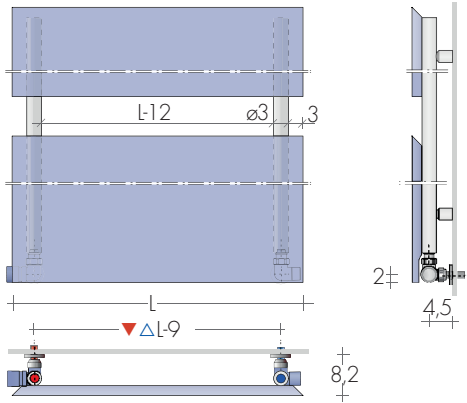

VERSIONI MISTE

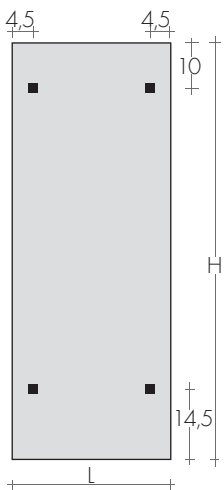
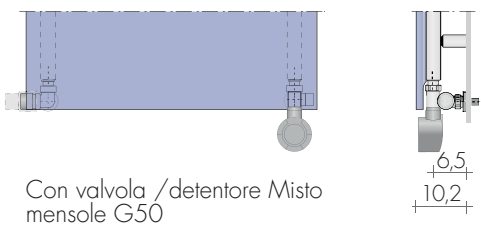

FISSAGGI  
Mensole G30  
comprese



PIASTRE

VALVOLE CONSIGLIATE

KIT VALVOLE CROMATE comprende:

- n°2 Valvole con codali
- n°2 Raccordi (per multistrato ø16 e rame ø12 e 14)
- n°2 Rosette tonde cromo ø 48, foro ø16

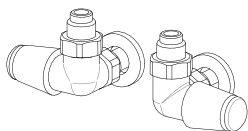

KIT VALVOLE TON comando LATERALE nichelate  
volantino cromo Art. KVLN 97,00€  
KIT VALVOLE TON comando LATERALE cromo  
pag.269 Art. KVL 139,20€

FINITURE SPECIALI

pag. 267  
Finiture Oro, Bronzo, Nickel spazzolato per 2 valvole  
KIT Raccordi NICKEL spazz. suppl.Art. RN 28,20€

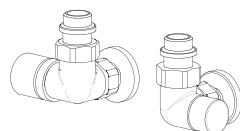

KIT VALVOLE CYL termostattabile con comando  
LATERALE, pag.273 Art. KCLD 150,50€  
Colore tabella BREM supplemento 49,50€

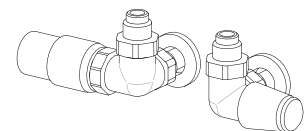

KIT VALVOLE TON comando LATERALE nichelate  
testa TERMOSTATICA, Art. KTLND 143,80€  
KIT VALVOLE TON comando LATERALE con testa  
TERMOSTATICA, pag.269 Art. KTLD 188,60€

design Luigi Brembilla

Piastra scaldasalviette realizzata su piastra PHUL di soli 23 mm di spessore dal bordo

rastremato e dotata di uno particolare maniglione portasalviette. La realizzazione

con gli allacciamenti di serie consente il montaggio con valvole nascoste dalla piastra.

## DIMENSIONI

Larghezza: 44 cm

Altezze: 80,5/96,5/124,5/148,5/168,5 cm

Profondità: 11 cm

Sporgenza dal muro: 14 cm

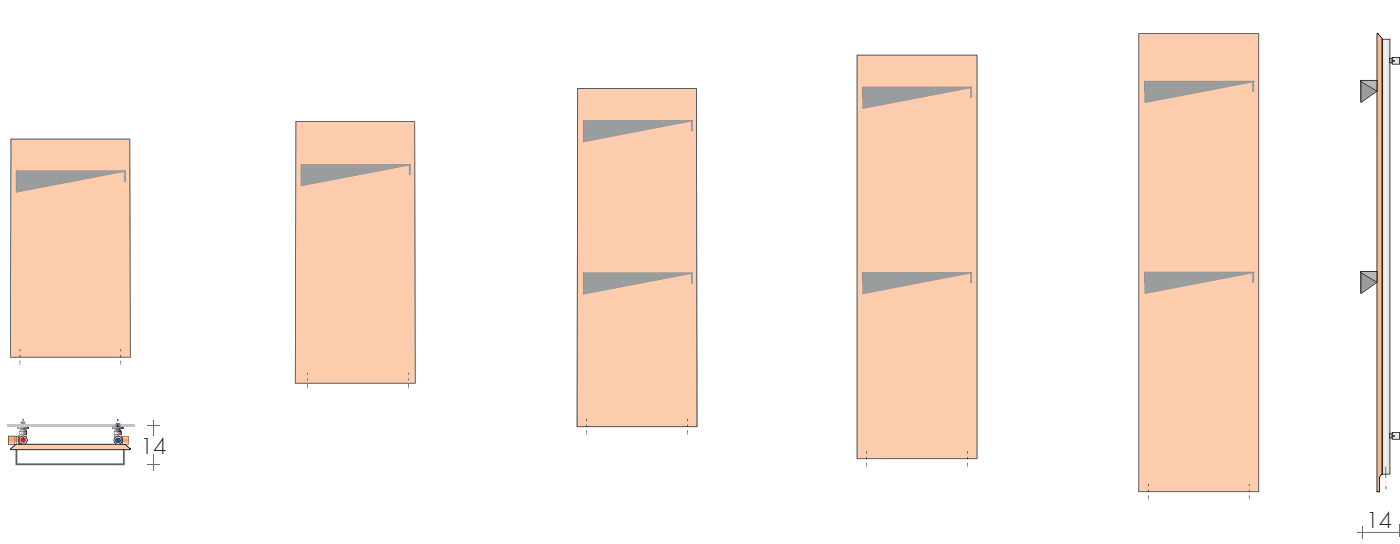

FLAG 80-44

FLAG 96-44

FLAG 124-44

FLAG 148-44

FLAG 168-44

## MODELLO'25

	HL cm	Bianco di serie sablé SB9016 €	$\Delta t$ 50K watt	EN 442 $\Delta t$ 40K watt	$\Delta t$ 30K watt	▲ ▼ int.att. cm	Altezza H cm	Largh. L cm	Peso M Kg	Volume V dm <sup>3</sup>	VERSIONI MISTE con Resistenza e * Watt €	
FLAG	80-44	596,80	409	309	215	35	80,5	44	10,7	3,1	400	95,70
FLAG	96-44	665,00	500	378	263	35	96,5	44	12,9	3,8	500	97,80
FLAG	124-44	794,90	659	498	347	35	124,5	44	17,4	5,1	650	99,80
FLAG	148-44	861,10	796	601	419	35	148,5	44	20,6	6,1	800	104,20
FLAG	168-44	916,60	909	686	478	35	168,5	44	23,3	7,0	900	107,50

\* Aggiungere: Valvola mista p.207  
Termostati p.208-209

## MANIGLIONE FLAG: COLORI DI SERIE

- bianco sablé SB 9016 - grigio sablé SB 7039  
- nero sablé SB 9005 - nel colore del radiatore

In un colore della tabella Brem diverso dallo  
scaldasalviette Supplemento 49,00€

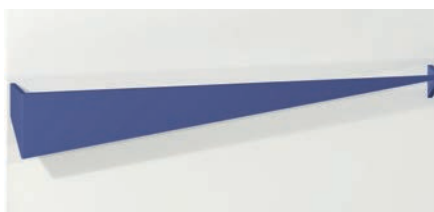

## ESECUZIONI DI SERIE

Colore bianco sablé SB9016 mensole bianche  
Tolleranze  $\pm$  3mm - Valvola di sfiato  $\varnothing$  1/2"  
PRESSIONE MASSIMA D'ESERCIZIO 6 BAR

## ESECUZIONI A RICHIESTA

Verniciatura tabella colori Brem  
mensole verniciate  
Versione elettrica, e.Flag p. 227

+15/25%

## ATTACCHI DI SERIE

EG  $\varnothing$  1/2"

Utilizzare valvole comando laterale



INTERASSE ATTACCHI

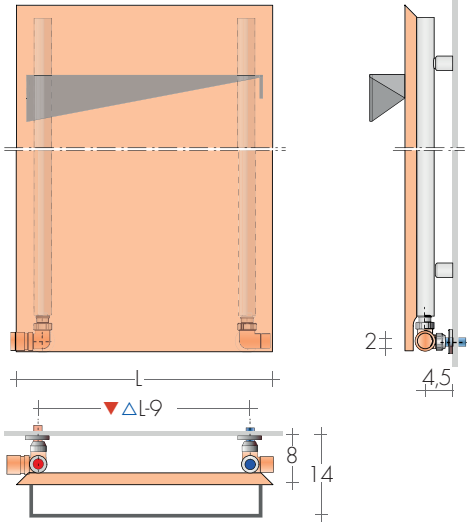

VERSIONI MISTE p.207

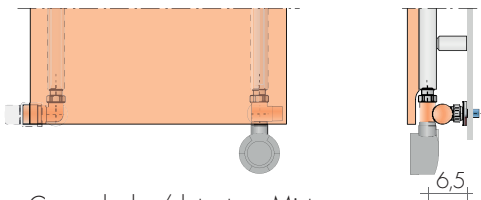

Con valvola /detettore Misto mensola G50

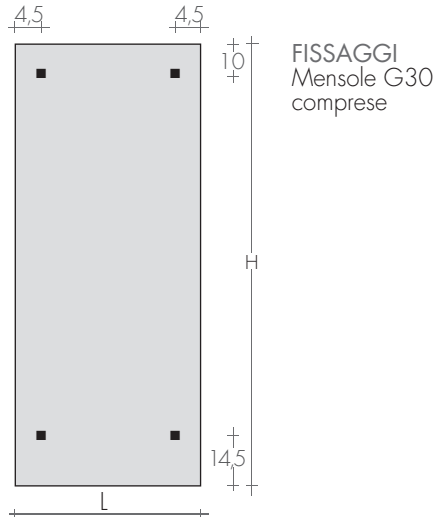

FISSAGGI  
Mensole G30  
comprese



PIASTRE

VALVOLE CONSIGLIATE

KIT VALVOLE CROMATE comprende:

- n°2 Valvole con codali
- n°2 Raccordi (per multistrato ø16 e rame ø12 e 14)
- n°2 Rosette tonde cromo ø 48, foro ø16

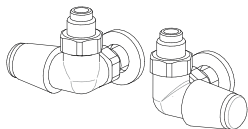

KIT VALVOLE TON comando LATERALE nichelate  
volantino cromo Art. KVLN 97,00€

KIT VALVOLE TON comando LATERALE cromo  
pag.269 Art. KVL 139,20€

FINITURE SPECIALI

pag. 267  
Finiture Oro, Bronzo, Nickel spazzolato per 2 valvole  
KIT Raccordi NICKEL spazz. suppl.Art. RN 28,20€

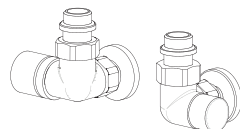

KIT VALVOLE CYL termostattizzabile comando  
LATERALE, pag.273 Art. KCLD 150,50€  
Colore tabella BREM supplemento 49,50€

COLORAZIONE BICOLOR:

BIC10 Cover della piastra in colore Brem a scelta  
con collettori e retro bianco sablé SB 9016 +10%  
BIC20 Cover in colore Brem a scelta con collettori e  
retro sablé nero SB9005 o grigio sablé SB7039+20%  
BIC35 N° 2 colori Brem a scelta +35%

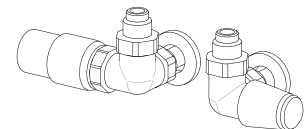

KIT VALVOLE TON comando LATERALE nichelate  
testa TERMOSTATICA, Art. KTLND 143,80€

KIT VALVOLE TON comando LATERALE con testa  
TERMOSTATICA, pag.269 Art. KTLD 188,60€

# GEOMETRICA TONDA - OVALE

PREZZI DAL 01.03.2026 +5%

design Luigi Brembilla

Geometrica è una collezione che si compone da scaldasalviette costituiti da elementi

geometrici e un maniglione orizzontale che li attraversa e li connota. Il maniglione porta-

salviette può essere anche realizzato con la sporgenza a sinistra del corpo radiante.

## TONDA Mod. Geo-T



\*Mod. Geo-TL  
con tubi sul retro

## OVALE Mod. Geo-O



\*Mod. Geo-OL  
con tubi sul retro

## OVALE-V Mod. Geo-OV



\*Mod. Geo-OVL  
con tubi sul retro

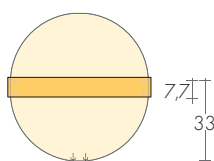

Geo-T.. 58-56

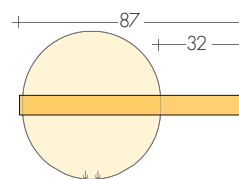

Geo-T.. 58-87



5,8

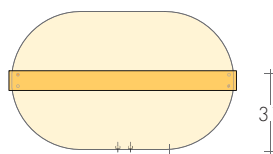

Geo-O.. 54-89

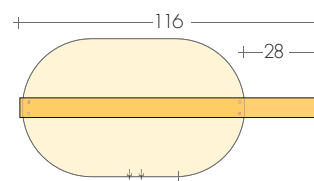

Geo-O.. 54-116



11,8

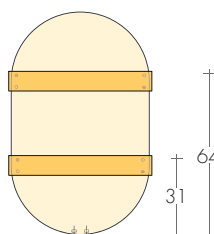

Geo-OV.. 87-56

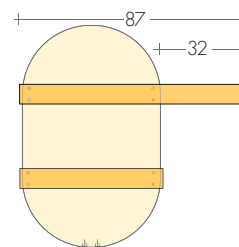

Geo-OV.. 87-87

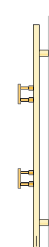

11,8

MODELLO	H-L cm	Bianco di serie sablé SB9016 €	EN 442			▲ ▽ int.att. cm	Altezza H cm	Larghezza L cm	Peso M Kg	Volume V dm <sup>3</sup>	VERSIONI MISTE con Resistenza e manicotto	
			Δt 50K watt	Δt 40K watt	Δt 30K watt						Watt	€
Geo-T	58-56	798,00	312	237	164	5	58	56	9,2	3,7	*250	93,60
Geo-TL	58-56	976,50	449	341	236	5	58	56	13,5	5,0	*400	95,70
Geo-T	58-87	824,30	344	261	181	5	58	87	9,8	3,9	*400	95,70
Geo-TL	58-87	1002,80	481	365	253	5	58	87	14,1	5,2	*500	97,80
Geo-O	54-89	850,50	514	391	270	5	54	89	15,0	6,2	500	119,30
Geo-OL	54-89	1029,00	734	558	386	5	54	89	21,9	8,3	650	121,30
Geo-O	54-116	887,30	543	413	286	5	54	116	15,5	6,3	500	119,30
Geo-OL	54-116	1065,80	763	580	401	5	54	116	22,4	8,4	800	125,70
Geo-OV	87-56	955,50	539	410	284	5	87	56	15,4	6,3	*500	97,80
Geo-OVL	87-56	1134,00	759	577	399	5	87	56	22,3	8,4	*800	104,20
Geo-OV	87-87	981,80	571	434	300	5	87	87	16,0	6,5	*650	99,80
Geo-OVL	87-87	1160,30	791	601	416	5	87	87	22,9	8,6	*800	104,20

A richiesta, senza supplemento, barra portasalviette con sporgenza a sinistra

\*Aggiungere: Valvola mista p.207  
Termostati p.208-209

### MANIGLIONE GEO COLORI DI SERIE

- bianco sablé SB 9016 - grigio sablé SB 7039  
- nero sablé SB 9005 - nel colore del radiatore

In un colore della tabella Brem diverso dallo scaldasalviette Supplemento 49,00€



### ESECUZIONI DI SERIE

Colore bianco sablé SB9016 mensole bianche  
Tolleranze ± 3mm - Valvola di sfianto ø 1/8"  
PRESSIONE MASSIMA D'ESERCIZIO 4 BAR

### ESECUZIONI A RICHIESTA

Verniciatura in una tinta della tabella colori Brem (con fissaggi B35 colorati) +15/25%  
Versione elettrica, e.Geo-T..O..OV p.230

### ATTACCHI DI SERIE EG ø 3/8"

A richiesta, senza supplemento, attacchi EG ø1/2"  
con manicotti sporgenti 2 cm



**INTERASSE ATTACCHI**

Attacchi EG  $\varnothing$  3/8", manicotti integrati  
Mod. Geo-T.. Geo-OV..

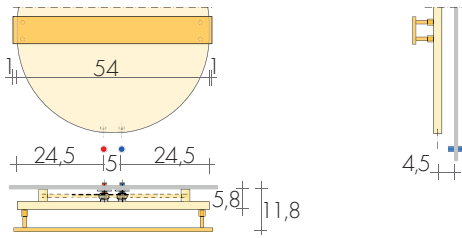

Mod. Geo-O..

\*RE.

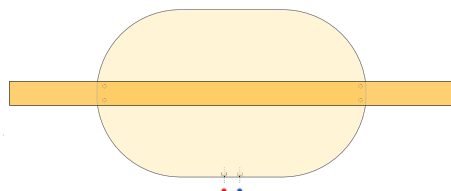
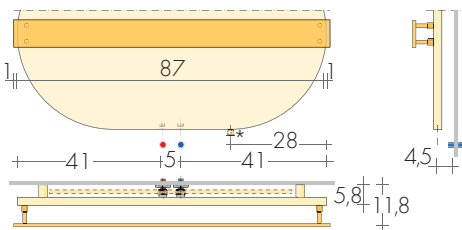

Mod. Geo-O 54-143 (571W) € 924,00

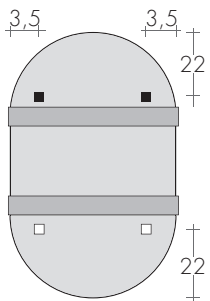

**FISSAGGI**  
Mensole B35  
comprese

mensole per  
modelli elettrici

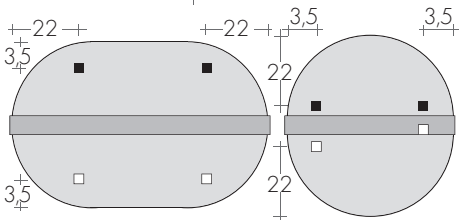
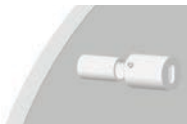

**VALVOLE CONSIGLIATE**

KIT VALVOLE CROMATE comprende:

- n°2 Valvole con codoli
- n°2 Raccordi (per multistrato  $\varnothing$ 16 e rame  $\varnothing$ 12 e 14)
- n°2 Rosette tonde cromo  $\varnothing$  48, foro  $\varnothing$ 16

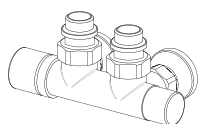

KIT valvola CYL BITUBO SX TERMOSTATIZZABILE  
▲▼ 5 cm, pag. 273 Art. KCB 158,80€  
Colore tabella BREM supplemento 49,50€

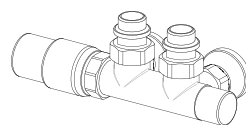

KIT valvola BITUBO SX con testa TERMOSTATICA  
▲▼ 5 cm, pag. 274 Art. KTB 186,60€  
Colori e finiture speciali pag.266-267

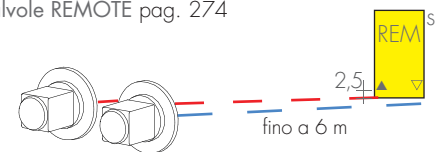

ATTACCHI REMOTI Art. REM 37,60€

Interasse attacchi sul retro: ▲▼ 5 cm

Valvole REMOTE pag. 274

KIT VALVOLE REMOTE TON con testa  
TERMOSTATICA, p. 274 Art. KVG 212,80€



Geo-T 58-56  
con attacchi remoti

# GEOMETRICA QUADRA - RETTANGOLARE

PREZZI DAL 01.03.2026 +5%

design Luigi Brembilla

La collezione Geometrica comprende anche i modelli Quadra e Rettangolare.

I modelli "L" hanno sul retro dei tubi che aumentano la resa calorica. Su richiesta la

barra portasalviette può essere fornita con la sporgenza a sinistra dello scaldasalviette.

## QUADRA Mod. Geo-Q

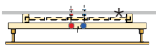

\*Mod. Geo-QL con tubi sul retro

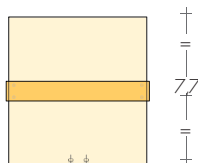

Geo-Q..58-56 / 67-65 / 76-74

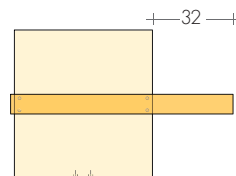

Geo-Q.. 58-87/67-102 / 76-116

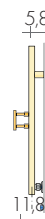

## RETTANGOLARE Mod. Geo-R

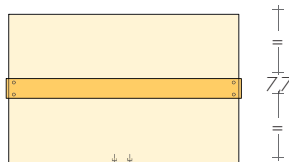

Geo-R 54-92 / 63-102

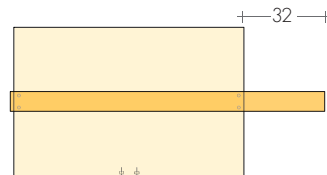

Geo-R 54-123 / 63-138

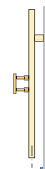

## RETTANGOLARE VERTICALE Mod. Geo-RV



\*Mod. Geo-RVL con tubi sul retro

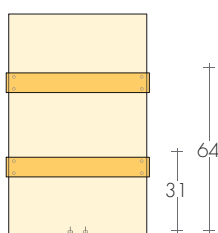

Geo-RV.. 87-56

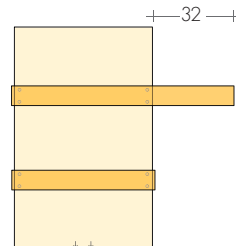

Geo-RV.. 87-87



MODELLO	HL cm	Biancodi serie sablé SB9016 €	EN 442			▲ ▽ int.att. cm	Altezza H cm	Larghezza L cm	Peso M Kg	Volume V dm <sup>3</sup>	VERSIONI MISTE con Resistenza e manicotto	
			Δt 50K watt	Δt 40K watt	Δt 30K watt						Watt	€
Geo-Q	58-56	845,30	411	312	216	5	58	56	11,6	3,7	400	117,20
Geo-QL	58-56	1023,80	525	399	276	5	58	56	15,2	4,8	500	119,30
Geo-Q	58-87	871,50	444	337	234	5	58	87	12,1	3,9	400	117,20
Geo-QL	58-87	1039,50	558	424	294	5	58	87	15,7	5,0	500	119,30
Geo-Q	67-65	900,90	540	410	284	5	67	65	15,2	4,7	500	119,30
Geo-QL	67-65	1110,90	708	538	372	5	67	65	20,5	6,3	650	121,30
Geo-Q	67-102	932,40	579	440	305	5	67	102	15,9	4,9	500	119,30
Geo-QL	67-102	1137,20	747	568	393	5	67	102	21,2	6,5	800	125,70
Geo-Q	76-74	955,50	685	520	360	5	76	74	19,3	5,8	650	121,30
Geo-QL	76-74	1197,00	918	697	483	5	76	74	26,6	8,0	900	129,00
Geo-Q	76-116	992,30	729	554	383	5	76	116	20,0	6,0	650	121,30
Geo-QL	76-116	1233,80	962	731	506	5	76	116	27,3	8,2	900	129,00
Geo-R	54-92	928,20	635	482	334	5	54	92	17,7	5,4	650	121,30
Geo-R	54-123	965,00	668	508	351	5	54	123	18,2	5,6	650	121,30
Geo-R	63-102	1058,90	802	609	422	5	63	102	22,4	6,7	800	125,70
Geo-R	63-138	1095,70	840	638	442	5	63	138	31,3	9,3	800	125,70
Geo-RV	87-56	950,30	639	486	336	5	87	56	17,5	5,4	650	121,30
Geo-RVL	87-56	1128,80	819	622	431	5	87	56	23,2	7,1	800	125,70
Geo-RV	87-87	976,50	671	510	353	5	87	87	18,1	5,6	650	121,30
Geo-RVL	87-87	1144,50	851	647	448	5	87	87	23,8	7,3	800	125,70

A richiesta, senza supplemento, barra portasalviette con sporgenza a sinistra

Termostati p.208-209

### MANIGLIONE GEO COLORI DI SERIE

- bianco sablé SB 9016 - grigio sablé SB 7039
- nero sablé SB 9005 - nel colore del radiatore

In un colore della tabella Brem diverso dallo scaldasalviette Supplemento 49,00€



Attacchi ø 3/8"  
DI SERIE  
(a filo piastra)



Attacchi ø 1/2"  
A RICHIESTA  
(con manicotti)

### ESECUZIONI DI SERIE

Colore bianco sablé SB9016 mensole bianche  
Tolleranze ± 3mm - Valvola di sfiato ø 1/8"  
PRESSIONE MASSIMA D'ESERCIZIO 4 BAR

### ESECUZIONI A RICHIESTA

Verniciatura in una tinta della tabella colori  
Brem (con fissaggi B35 colorati) +15/25%  
Versione elettrica, e.Geo-Q..R..RV.. p.231

### ATTACCHI DI SERIE EG ø 3/8"

A richiesta, senza supplemento,  
attacchi EG ø 1/2" con manicotti  
sporgenti 2 cm



### INTERASSE ATTACCHI

Attacchi EG ø 3/8", manicotti integrati

Geo-Q.. Geo-RV..

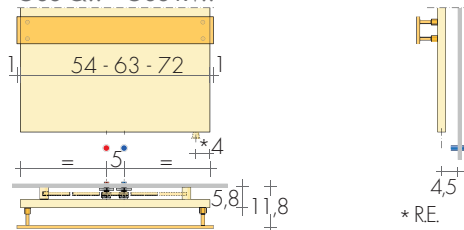

Geo-R..

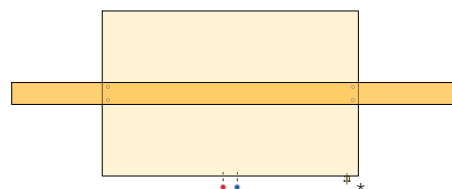
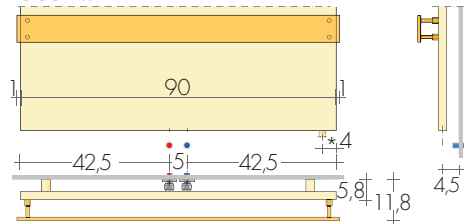

Mod. Geo-R 54-154 (701W) € 1001,70

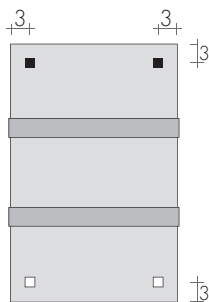

**FISSAGGI**  
Mensole B35  
comprese

□ mensole per  
modelli elettrici

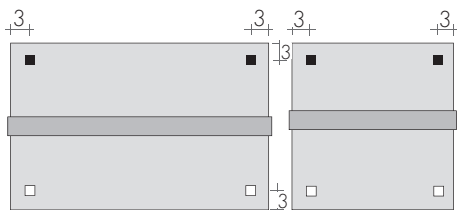

### VALVOLE CONSIGLIATE

KIT VALVOLE CROMATE comprende:

- n°2 Valvole con codoli
- n°2 Raccordi (per multistrato ø16 e rame ø12 e 14)
- n°2 Rosette tonde cromo ø 48, foro ø16

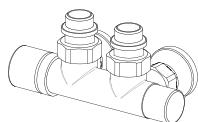

KIT valvola CYL BITUBO SX TERMOSTATIZZABILE  
▲▼ 5cm, pag. 273 Art. KCB 158,80€  
Colore tabella BREM supplemento 49,50€

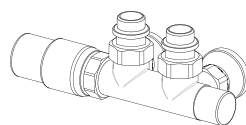

KIT valvola BITUBO SX con testa TERMOSTATICA  
▲▼ 5cm, pag. 274 Art. KTB 186,60€  
Colori e finiture speciali pag.266-267

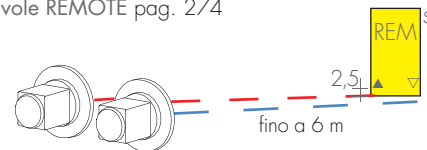

ATTACCHI REMOTI Art. REM 37,60€

Interasse attacchi sul retro: ▲▼ 5 cm

Valvole REMOTE pag. 274

KIT VALVOLE REMOTE TON con testa  
TERMOSTATICA, p. 274 Art. KVGT 212,80€



Geo-Q 67-65

con attacchi remoti

design Fiorenzo Mussi

Rigoroso e lineare, Hot punta sulla sintesi monocromatica utilizzando la luce come

elemento dinamico che evidenzia il suo nome formato dalle lettere H e T in rilievo e dal gioco

del portasalviette che crea la O. HOT è realizzato su piastra con i bordi rastremati.

## DIMENSIONI

Larghezza: 54

Altezze: 84,5/104,5/128,5/140,5/180,5 cm

Profondità: 11 cm

Sporgenza dal muro: 8 / 14 cm

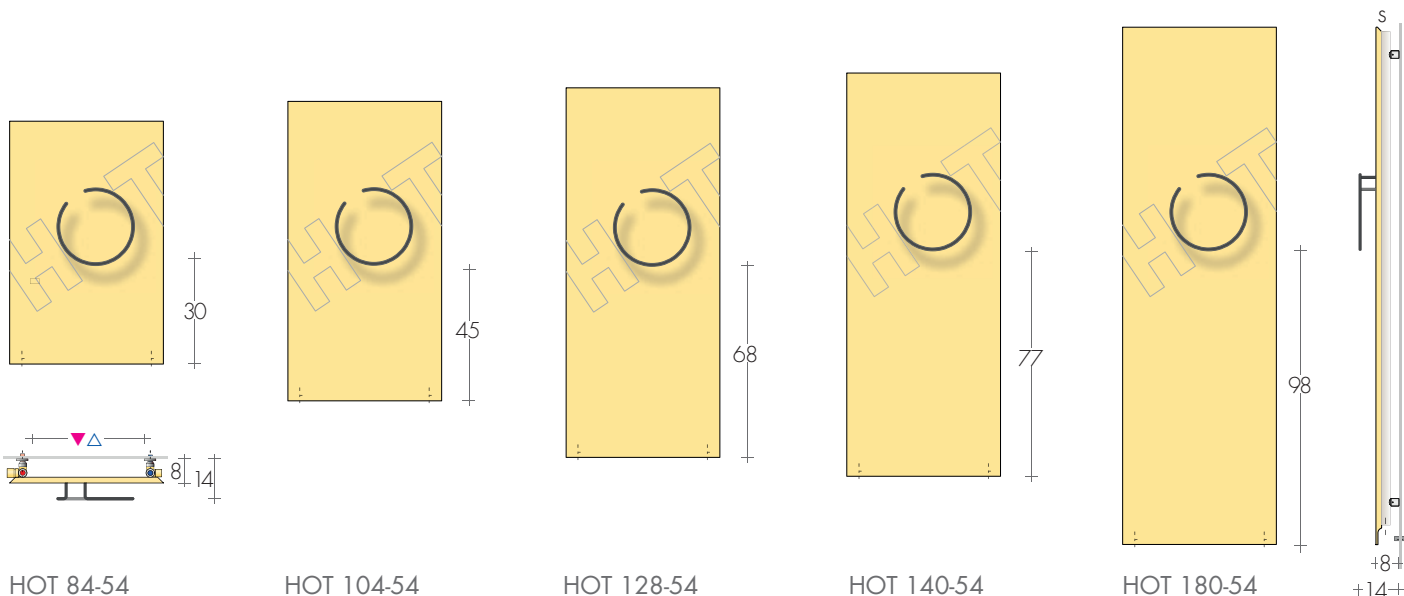

HOT 84-54

HOT 104-54

HOT 128-54

HOT 140-54

HOT 180-54

+8+  
+14+

## MODELLO'25

MODELLO'25	H-L cm	Biancodi serie sablé SB9016 €	$\Delta t$ 50 K watt	EN 442			$\blacktriangle \nabla$ int.att. cm	Altezza H cm	Larghezza L cm	Peso M Kg	Volume V dm <sup>3</sup>	VERSIONI MISTE con Resistenza e *	
				$\Delta t$ 40 K watt	$\Delta t$ 30 K watt	Watt						€	
HOT	84-54	681,00	519	392	273	45	84,5	54	13,2	3,9	500	97,80	
HOT	104-54	718,90	656	495	345	45	104,5	54	16,4	4,9	650	99,80	
HOT	128-54	766,90	820	619	431	45	128,5	54	20,5	6,2	800	104,20	
HOT	140-54	823,10	902	681	474	45	140,5	54	22,4	6,8	900	107,50	
HOT	180-54	1031,70	1175	887	618	45	180,5	54	28,9	8,9	1200	115,20	

\* Aggiungere: Valvola mista p.207  
Termostati p.208-209

## MANIGLIONE HOT: COLORI DI SERIE

- bianco sablé SB 9016 - grigio sablé SB 7039  
- oro metallizzato BRO019 - nero sablé SB 9005  
- nel colore del radiatore

In un colore della tabella Brem diverso dallo  
scaldasalviette Supplemento 49,00€



## ESECUZIONI DI SERIE

Colore bianco sablé SB9016 mensola G30  
Tolleranze  $\pm$  3mm - Valvola di sfianto  $\varnothing$  1/2"  
Pressione massima d'esercizio 6 bar.

## ESECUZIONI A RICHIESTA

Verniciatura tabella colori Brem  
mensola verniciata  
Versione elettrica, su richiesta

+15/25%

## ATTACCHI DI SERIE

EG  $\varnothing$  1/2"

Utilizzare valvole comando laterale



### INTERASSE ATTACCHI

Di serie attacchi nascosti per valvole con comando laterale

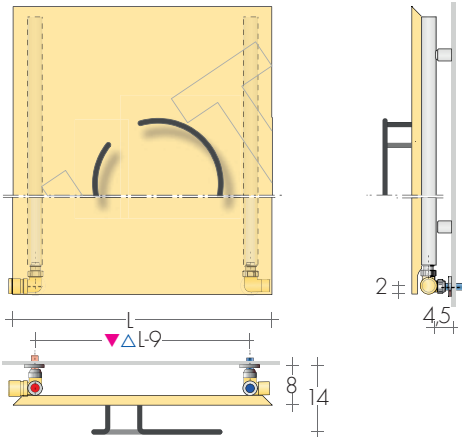

### VERSIONI MISTE p.207

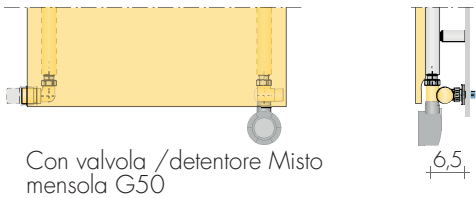

Con valvola /detettore Misto mensola G50

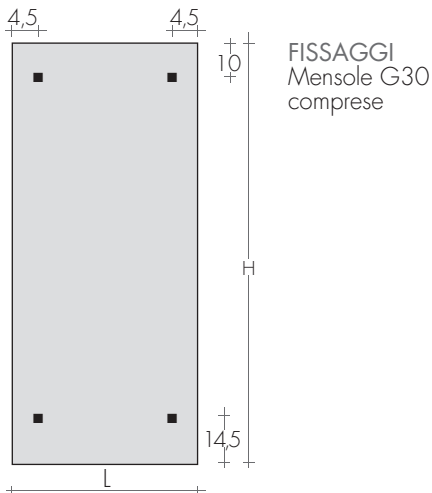

FISSAGGI  
Mensole G30  
comprese



HOT 140-54

### VALVOLE CONSIGLIATE

KIT VALVOLE CROMATE comprende:

- n°2 Valvole con codali
- n°2 Raccordi (per multistrato ø16 e rame ø12 e 14)
- n°2 Rosette tonde cromo ø 48, foro ø16

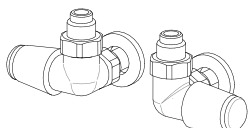

KIT VALVOLE TON comando LATERALE nichelate  
volantino cromo Art. KVLN 97,00€

KIT VALVOLE TON comando LATERALE cromo  
pag.269 Art. KVL 139,20€

### FINITURE SPECIALI

pag. 267  
Finiture Oro, Bronzo, Nickel spazzolato per 2 valvole  
KIT Raccordi NICKEL spazz. suppl.Art. RN 28,20€

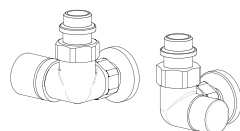

KIT VALVOLE CYL termostaticabile comando  
LATERALE, pag.273 Art. KCLD 150,50€  
Colore tabella BREM supplemento 49,50€

### COLORAZIONE BICOLOR:

BIC10 Cover della piastra in colore Brem a scelta  
con collettori e retro bianco sablé SB 9016 +10%  
BIC20 Cover in colore Brem a scelta con collettori e  
retro sablé nero SB9005 o grigio sablé SB7039+20%  
BIC35 N° 2 colori Brem a scelta +35%

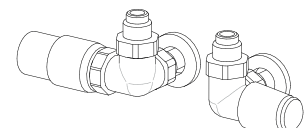

KIT VALVOLE TON comando LATERALE nichelate  
testa TERMOSTATICA, Art. KTLND 143,80€

KIT VALVOLE TON comando LATERALE con testa  
TERMOSTATICA, pag.269 Art. KTLD 188,60€

design Davide Diliberto

Piastra scaldasalviette con l'esclusiva forma a semicerchio prodotta nella versione

LOGGIA DESIGN con il maniglione portasalviette in tubo quadrato di 15 mm ed

in quella LOGGIA TIMELESS dal maniglione in trafilato piatto con le estremità sagomate.

## DIMENSIONI

Larghezza: 54 cm

Altezze: 117 / 137 / 167; Piastre 167/197 / 217 cm

Profondità: Loggia-D 8,1 cm / Loggia-T 7,3 cm

Sporgenza dal muro: Loggia-D 11,6 cm / Loggia-T 10,8 cm

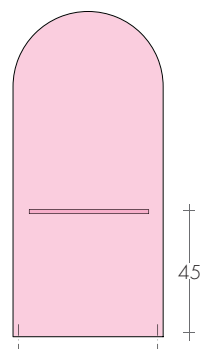

LOGGIA.. 117-54

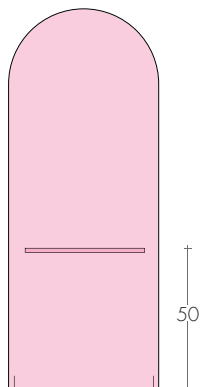

LOGGIA.. 137-54

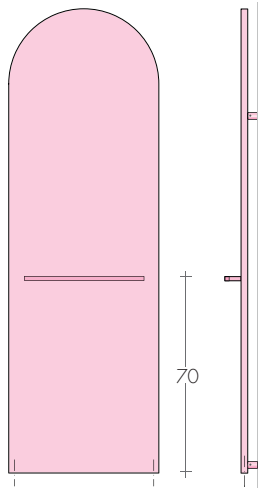

LOGGIA.. 167-54

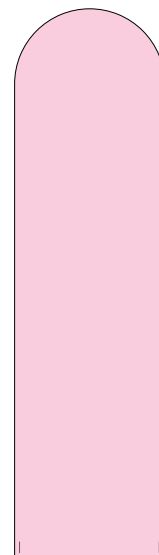

LG..H-167-54

LG..H-197-54

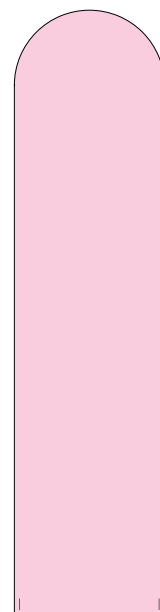

LG..H-217-54

5,8

Piastre con maniglioni a richiesta.



LOGGIA-D (DESIGN)



LOGGIA-T (TIMELESS)

MODELLO	HL cm	Bianco di serie sablé SB9016 €	EN 442			▲▼ int.att. cm	Altezza H cm	larghezza L cm	Peso M Kg	Volume V dm³	VERSIONI MISTE con Resistenza e * Watt €	
			Δt 50 K watt	Δt 40 K watt	Δt 30 K watt						Watt	€
LOGGIA-D	117-54	993,10	641	485	337	50	117	54	19,0	6,0	650	99,80
LOGGIA-D	137-54	1061,70	758	574	398	50	137	54	22,0	7,0	800	104,20
LOGGIA-D	167-54	1156,60	933	706	490	50	167	54	27,0	8,0	900	107,50
LOGGIA-T	117-54	1011,20	641	485	337	50	117	54	19,0	6,0	650	99,80
LOGGIA-T	137-54	1079,70	758	574	398	50	137	54	22,0	7,0	800	104,20
LOGGIA-T	167-54	1174,60	933	706	490	50	167	54	27,0	8,0	900	107,50
LOGGIA CALORIFERO (maniglioni a richiesta)												
LGH	167-54	1102,20	933	706	490	50	167	54	27,0	8,0	900	107,50
LGLH	167-54	1290,10	1233	933	647	50	167	54	36,5	8,7	1200	115,20
LGH	197-54	1197,10	1107	838	581	50	197	54	31,7	9,4	1200	115,20
LGLH	197-54	1445,50	1476	1117	775	50	197	54	43,4	12,9	1500	125,40
LGH	217-54	1251,00	1224	927	643	50	217	54	35,0	10,4	1200	115,20
LGLH	217-54	1554,10	1638	1240	860	50	217	54	48,1	14,3	1500	125,40

ALTEZZA 207 valori e prezzi per interpolazione.

Altre altezze LGH e LGLH, a richiesta.

\* Aggiungere: Valvola mista p.207  
Termostati p.208-209

## MANIGLIONE LOGGIA: COLORI DI SERIE

- bianco sablé SB 9016 - grigio sablé SB 7039  
- nero sablé SB 9005 - nel colore del radiatore

## MANIGLIONE SUPPLEMENTARE

Maniglione Design Art. MLD 54,40€  
Maniglione Timeless Art. MLT 72,50€

In un colore della tabella Brem diverso dallo scaldasalviette Supplemento 49,00€

## ESECUZIONI DI SERIE

Colore bianco sablé SB9016, mensola B35  
Tolleranze ± 3mm - Valvola di sfianto ø 1/8"  
PRESSIONE MASSIMA D'ESERCIZIO 4 BAR

## ESECUZIONI A RICHIESTA

Verniciatura in una tinta della tabella colori  
Brem con fissaggi colorati +15/25%  
Versione elettrica e Loggia, pag. 245

## ATTACCHI DI SERIE

EG ø 3/8"  
su richiesta ø 1/2"  
Attacchi speciali, p.278



INTERASSE ATTACCHI EG

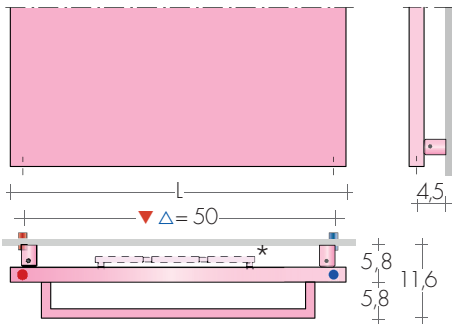

LOGGIA Design

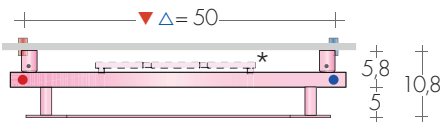

LOGGIA Timeless

\*Modello ..L con tubi sul retro



Attacchi  $\varnothing$  3/8"  
DI SERIE  
(a filo piastra)



Attacchi  $\varnothing$  1/2"  
A RICHIESTA  
(con manicotti)

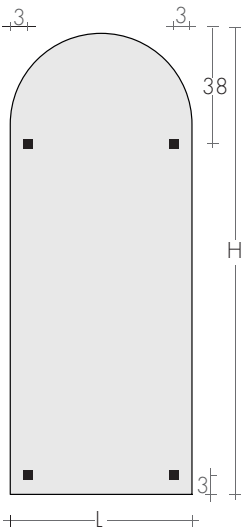

FISSAGGI  
Mensole comprese



Mensola B35



LOGGIA-D 167-54

VALVOLE CONSIGLIATE

KIT VALVOLE CROMATE comprende:

- n°2 Valvole con codoli
- n°2 Raccordi (per multistrato  $\varnothing$ 16 e rame  $\varnothing$ 12 e 14)
- n°2 Rosette tonde cromo  $\varnothing$  48, foro  $\varnothing$ 16

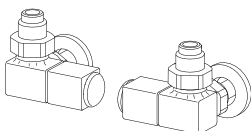

KIT VALVOLE QUADRA comando LATERALE  
pag. 271 Art. KQL 177,10€  
Colore tabella BREM supplemento 49,50€

FINITURE SPECIALI pag. 267

Finiture Oro, Bronzo, Nickel spazzolato per 2 valvole  
KIT Raccordi NICKEL spazz. suppl.Art. RN 28,20€

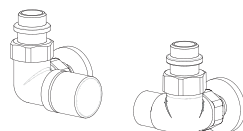

KIT VALVOLE CYL termostatzabile con comando LATERALE, pag.273 Art. KCL 150,50€  
Colore tabella BREM supplemento 49,50€

ATTACCHI REMOTI Art. REM 37,60€

Interasse attacchi sul retro:  $\Delta$  L - 5 cm

Valvole REMOTE pag. 274

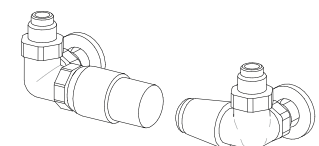
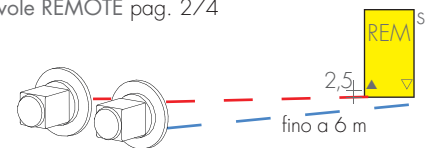

KIT VALVOLE TON comando LATERALE con testa TERMOSTATICA, pag. 269 Art. KTL 188,60€

design Luigi Brebbia

L'essenzialità della piastra dallo spessore di soli 2,3 cm e la praticità del maniglione

doppio libero su tre lati esaltano il design di questo scaldasalviette.

A richiesta, il maniglione, può essere verniciato in una tinta BREM diversa della piastra.

## DIMENSIONI

Larghezze: 36 / 45 / 54 cm

Altezze 80 / 130 / 180 cm

Profondità 9,5 cm

Sporgenza dal muro 12,8 cm

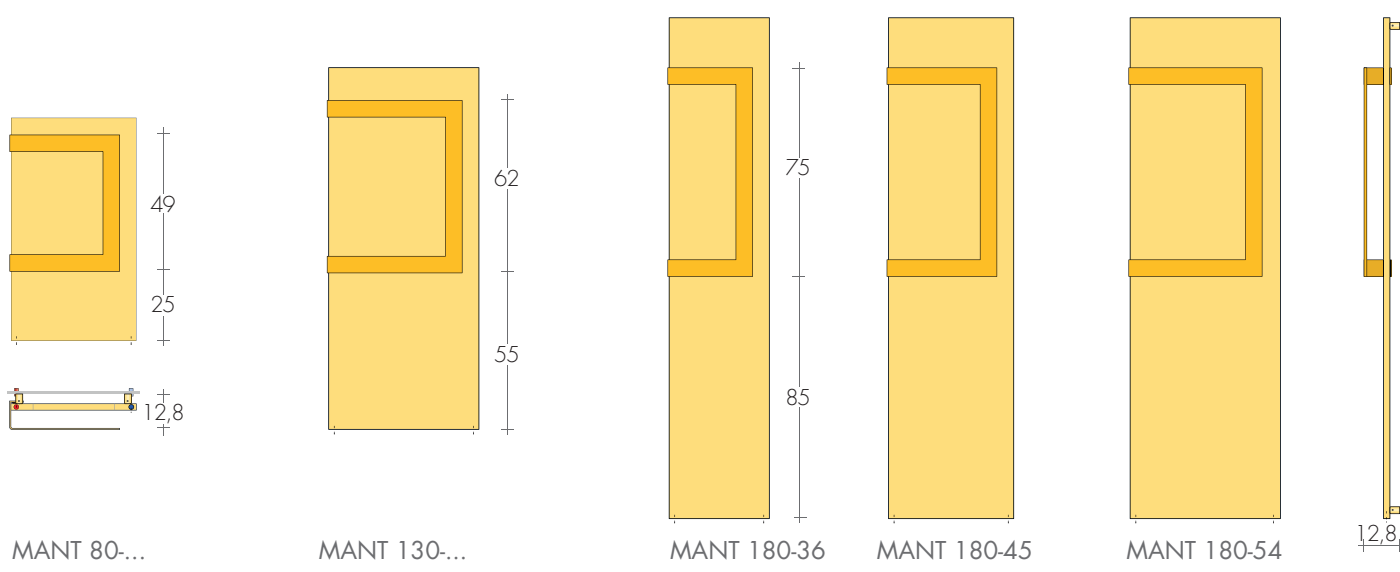

MANT 80-...

MANT 130-...

MANT 180-36

MANT 180-45

MANT 180-54

12,8

MODELLO	H/L cm	Bianco di serie sablé SB9016 €	Δt 50K watt	EN 442 Δt 40K watt	Δt 30K watt	▲ ▼ int.att. cm	Altezza H cm	Larghezza L cm	Peso M Kg	Volume V dm <sup>3</sup>	VERSIONI MISTE con Resistenza e *	
											Watt	€
MANT	80-45	770,30	399	302	210	41	80	45	11,3	3,8	400	95,70
MANT	80-54	839,70	478	362	251	50	80	54	13,5	4,4	500	97,80
MANT	130-45	921,90	643	487	338	41	130	45	18,2	6,0	650	99,80
MANT	130-54	1001,10	770	583	405	50	130	54	21,8	6,8	800	104,20
MANT	180-36	982,20	714	540	376	32	180	36	20,3	7,0	650	99,80
MANT	180-45	1073,50	887	671	466	41	180	45	25,1	8,1	900	107,50
MANT	180-54	1162,20	1061	803	558	50	180	54	30	9,2	900	107,50
MANT-L	180-45	1295,00	1181	894	621	41	180	45	34,4	8,1	1200	115,20

A richiesta, senza supplemento, maniglione a destra

\*Aggiungere: Valvola mista o TR p.207  
Termostati p.208-209

## MANIGLIONE MANT: COLORI DI SERIE

- bianco sablé SB 9016 - grigio sablé SB 7039
- nero sablé SB 9005 - nel colore del radiatore

In un colore della tabella Brem diverso dallo scaldasalviette Supplemento 49,00€

## ESECUZIONI DI SERIE

Colore bianco sablé SB9016, mensola B35  
Tolleranze ± 3mm - Valvola di sfianto ø 1/8"  
PRESSIONE MASSIMA D'ESERCIZIO 4 BAR

## ESECUZIONI A RICHIESTA

Verniciatura in una tinta della tabella colori  
Brem con fissaggi colorati +15/25%  
Versione elettrica e.Mant, p. 246

## ATTACCHI DI SERIE

EG ø 3/8"  
A richiesta ø 1/2", con manicotti  
Attacchi speciali, pag.279



INTERASSE ATTACCHI EG 3/8" verticali  
 A richiesta attacchi laterali 3/8" o 1/2"  
 Supplemento Art. AS 81,40€

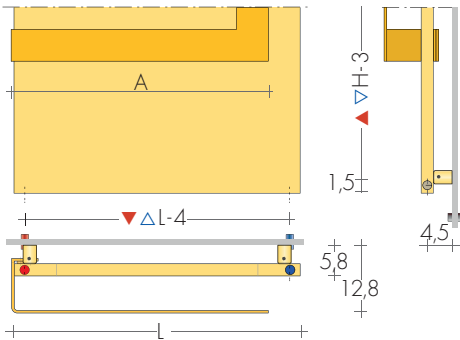

larghezza MANIGLIONE MANT  
 L36 A 30,5 - L45 A 39,5 - L54 A 48,5 cm



Attacchi  $\varnothing$  3/8"  
 DI SERIE  
 (a filo piastra)



Attacchi  $\varnothing$  1/2"  
 A RICHIESTA  
 (con manicotti)

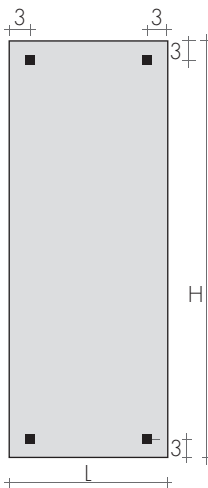

FISSAGGI  
 Mensole comprese



Mensola B35



MANT 130-54

## VALVOLE CONSIGLIATE

KIT VALVOLE CROMATE comprende:

- n°2 Valvole con codoli
- n°2 Raccordi (per multistrato  $\varnothing$ 16 e rame  $\varnothing$ 12 e 14)
- n°2 Rosette tonde cromo  $\varnothing$  48, foro  $\varnothing$ 16

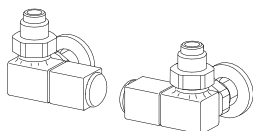

KIT VALVOLE QUADRA comando LATERALE  
 pag. 271 Art. KQL 177,10€  
 Colore tabella BREM supplemento 49,50€

FINITURE SPECIALI pag. 267

Finiture Oro, Bronzo, Nickel spazzolato per 2 valvole

KIT Raccordi NICKEL spazz. suppl. Art. RN 28,20€

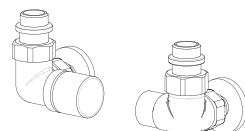

KIT VALVOLE CYL TERMOSTATIZZABILE comando  
 LATERALE, pag.273 Art. KCL 150,50€  
 Colore tabella BREM supplemento 49,50€

ATTACCHI REMOTI Art. REM 37,60€

Interasse attacchi sul retro:  $\nabla$  L - 5 cm

Valvole REMOTE pag. 274

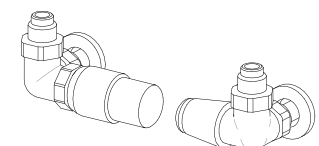
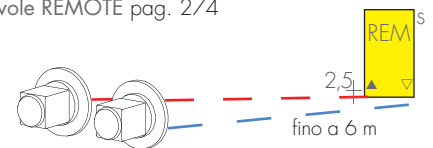

KIT VALVOLE TON comando LATERALE con testa  
 TERMOSTATICA, pag. 269 Art. KTL 188,60€

L'essenzialità della piastra, in colori a scelta, la leggerezza e la praticità di maniglioni

cromati a sezione quadra, sono protagonisti di PLATT COLOR. È prodotto anche con la

finitura foglia dorata o argento per il più ricco degli effetti scenici.

## DIMENSIONI

Larghezze: 52 / 53 / 59 / 63 / 66 cm  
 Altezze: 80 / 84 / 130 / 133 / 140 / 180 cm  
 Profondità 11,5 cm  
 Sporgenza dal muro 14 cm

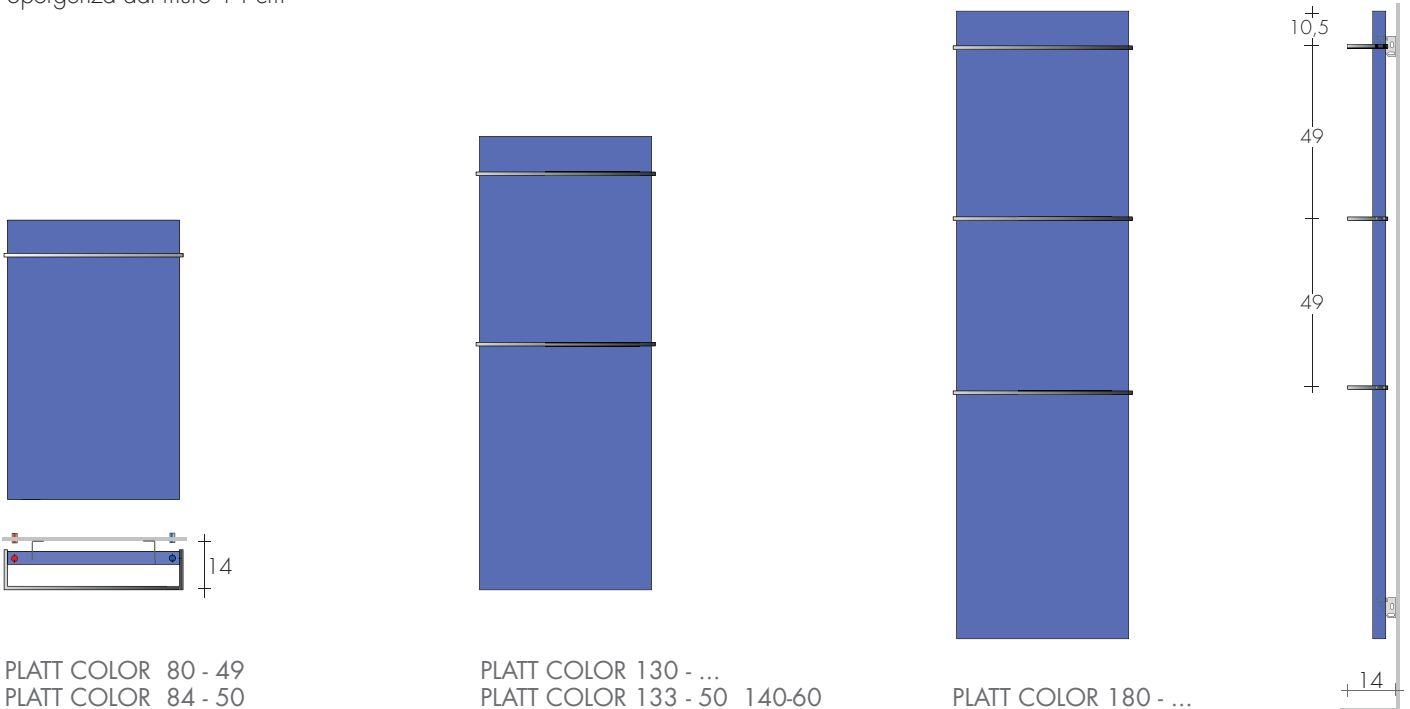

PLATT COLOR 80 - 49  
 PLATT COLOR 84 - 50

PLATT COLOR 130 - ...  
 PLATT COLOR 133 - 50 140-60

PLATT COLOR 180 - ...

MODELLO	HI cm	Bianco di serie sablé SB9016 €	EN 442			▲▼ int.att. cm	Altezza H cm	Larghezza L cm	Peso M Kg	Volume V dm <sup>3</sup>	VERSIONI MISTE con Resistenza e *	
			Δt 50K watt	Δt 40K watt	Δt 30K watt						Watt	€
PLATT COLOR	80-49	702,20	388	290	199	45	80	52	12,1	3,4	-	-
PLATT COLOR	130-49	920,10	610	456	314	45	130	52	18,6	5,2	-	-
PLATT COLOR	130-63	1030,50	784	586	403	59	130	66	23,8	6,8	-	-
PLATT COLOR	180-49	1127,30	817	611	420	45	180	52	25,4	7,0	-	-
PLATT COLOR	180-56	1212,60	934	699	480	52	180	59	29,1	8,0	-	-
PLATT COLOR	180-63	1297,80	1051	786	540	59	180	66	32,7	9,0	-	-
PLATT COLOR	84-50	762,00	427	319	219	46,8	84	53	12,5	3,8	400	95,70
PLATT COLOR	133-50	1030,50	645	482	331	46,8	133	53	19,9	5,9	650	99,80
PLATT COLOR	140-60	1166,80	810	606	316	56,8	140	63	25,1	7,5	800	104,20

Maniglione cromato di serie per PLATT COLOR      ▶ Pronta consegna

\*Aggiungere: Valvola mista o TR p.207  
 Termostati p.208-209

## MANIGLIONE PLATT COLORATO

A richiesta senza supplemento:  
 - bianco sablé SB 9016 - grigio sablé SB 7039  
 - nero sablé SB 9005 - nel colore del radiatore

PRESSIONE MASSIMA D'ESERCIZIO 6 BAR

In un colore della tabella Brem diverso dallo scaldasalviette Supplemento **49,00€**

## ESECUZIONI DI SERIE

Colore bianco sablé SB9016, mensola EOS  
 Tolleranze ± 3mm - Valvola di sfianto ø 1/8"

## ESECUZIONI A RICHIESTA

Verniciatura in una tinta della tabella colori  
 Brem con fissaggi colorati +15/25%

## ATTACCHI DI SERIE - EG ø 1/2"

Attacchi a richiesta, pag. 278  
 Versione elettrica e.Platt, pag. 250



INTERASSE ATTACCHI

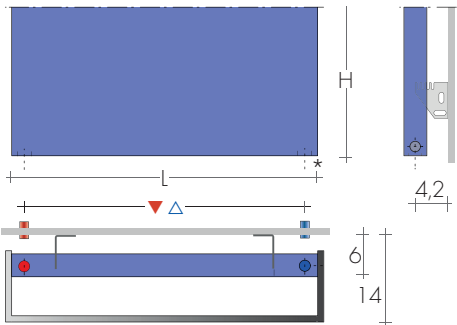

\* R.E. per versioni Miste

A richiesta attacchi laterali ▲▽ = H-3,2 cm  
Supplemento Art. AS 81,40€



PLATT COLOR 130-49

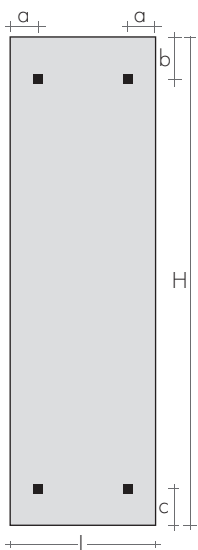

FISSAGGI  
Mensole comprese



Mensola EOS

Platt Color Hcm	a cm	b cm	c cm
80, 130, 180	7	8	11
84, 133, 140	6	6,5	5

VALVOLE CONSIGLIATE

KIT VALVOLE CROMATE comprende:

- n°2 Valvole con codali
- n°2 Raccordi (per multistrato ø16 e rame ø12 e 14)
- n°2 Rosette tonde cromo ø 48, foro ø16

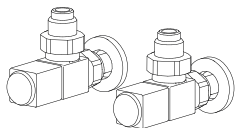

KIT VALVOLE QUADRA a SQUADRA  
pag.271 Art. KQS 166,80€  
Colore tabella BREM supplemento 49,50€

FINITURE SPECIALI pag. 267  
Finiture Oro, Bronzo, Nickel spazzolato per 2 valvole  
KIT Raccordi NICKEL spazz. suppl.Art. RN 28,20€

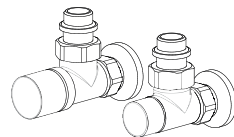

KIT VALVOLE CYL termostattabile a SQUADRA  
pag.273 Art. KCS 138,80€  
Colore tabella BREM supplemento 49,50€

ATTACCHI REMOTI Art. REM 37,60€  
Interasse attacchi sul retro: ▲▽ EG  
Valvole REMOTE pag. 274

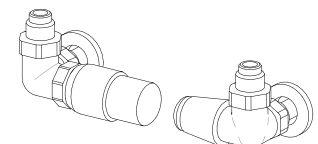
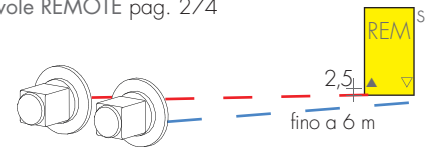

KIT VALVOLE TON comando LATERALE con testa  
TERMOSTATICA, pag. 269 Art. KTL 188,60€

Puro high-tech esaltato dalla finitura inox. La piastra radiante, in acciaio inox spazzolato, è completata da maniglioni inox dalla sezione quadra e dall'estetica rarefatta. Una piastra scaldasalviette tutta funzionalità, essenzialità e bellezza.

Maniglione inox di serie per Platt Inox.

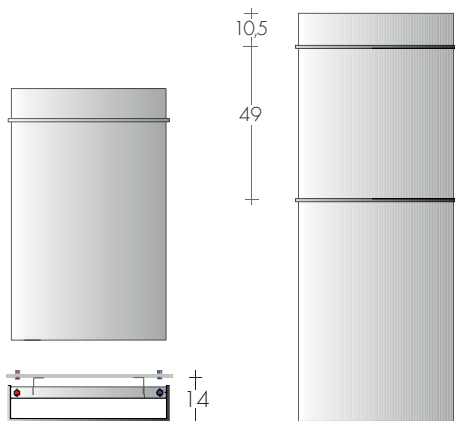

PLATT INOX 80-49  
PLATT INOX 84-50

PLATT INOX 130-...  
133-50 / 140-60

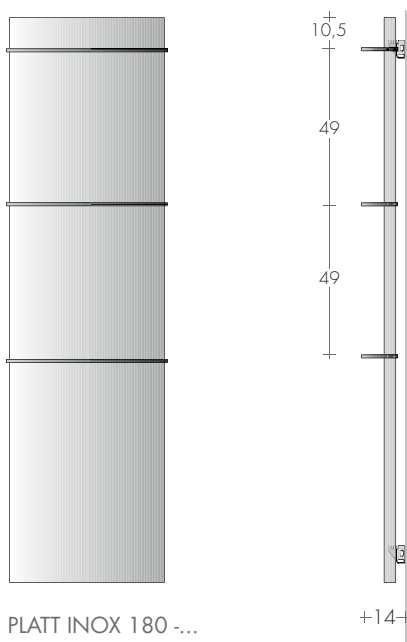

PLATT INOX 180-...



PLATT INOX 180-49

## DATI TECNICI PLATT COLOR pag 140



### VALVOLE FINITURA NICHEL SPAZZOLATO

Valvola TON e QUADRA, e rosetta con finitura nichel spazzolato pag. 267

## MODELLO

	HL cm	INOX spazzolato €	Δt 50K watt	EN 442 Δt 40K watt	Δt 30K watt	▲▼ int.att. cm	VERSIONI MISTE Resistenza e * Watt	€
PLATT INOX	80-49	1039,30	388	290	199	45	-	-
PLATT INOX	130-49	1361,70	610	456	314	45	-	-
PLATT INOX	130-63	1571,40	784	586	403	59	-	-
PLATT INOX	180-49	1668,50	817	611	420	45	-	-
PLATT INOX	180-56	1794,60	934	699	480	52	-	-
PLATT INOX	180-63	1920,50	1051	786	540	59	-	-
PLATT INOX	84-50*	1113,80	427	319	219	46,8	400	95,70
PLATT INOX	133-50*	1460,60	645	482	331	46,8	650	99,80
PLATT INOX	140-60*	1548,80	810	606	316	56,8	800	104,20
PLATT inox LUCIDO		+20%						

\*Aggiungere: Valvola mista o TR p.207 - Termostati p.208-209

# PLATT FOGLIA DORATA/ARGENTO

PREZZI DAL 01.03.2026 +5%

Estetica leggera, in forme minimaliste, cromie importanti, mai marginali nell'ambiente. PLATT è prodotto anche con la finitura foglia dorata (FO) o argento (FA) per il più ricco degli effetti scenici.

Maniglione di serie verniciato BR0019 per finitura foglia dorata e BR0002 per foglia argento. Supplemento maniglione foglia O/A cad. 134,70€

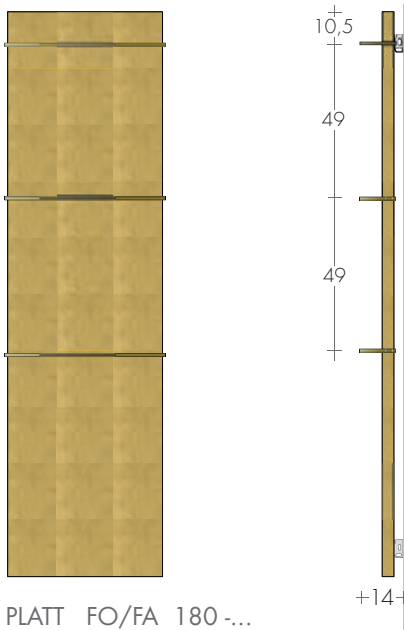
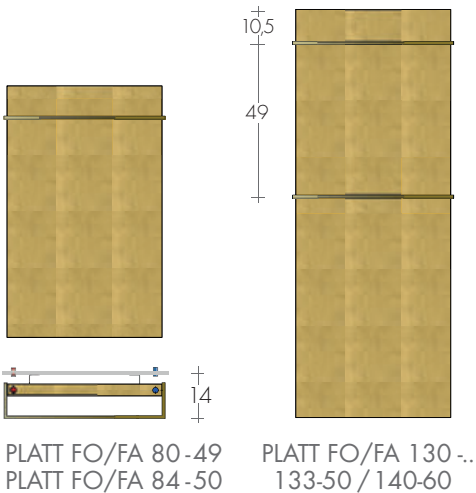

DATI TECNICI PLATT COLOR pag 140



VALVOLE FINITURA SPECIALI

Valvola TON e QUADRA, con finitura oro, in foglia dorata o foglia argento. pag 267

MODELLO	HL cm	Esecuzione Foglia Dorata / Argento €	EN 442			▲ ▽ int.att. cm	VERSIONI MISTE e	
			Δt 50K watt	Δt 40K watt	Δt 30K watt		Resistenza * Watt	€
PLATT FO/FA 80-49	80-49	1380,10	388	290	199	45	-	-
PLATT FO/FA 130-49	130-49	1778,40	610	456	314	45	-	-
PLATT FO/FA 130-63	130-63	1991,10	784	586	403	59	-	-
PLATT FO/FA 180-49	180-49	2257,10	817	611	420	45	-	-
PLATT FO/FA 180-56	180-56	2388,80	934	699	480	52	-	-
PLATT FO/FA 180-63	180-63	2520,20	1051	786	540	59	-	-
PLATT FO/FA 84-50*	84-50*	1440,10	427	319	219	46,8	400	95,70
PLATT FO/FA 133-50*	133-50*	1902,40	645	482	331	46,8	650	99,80
PLATT FO/FA 140-60*	140-60*	2158,70	810	606	316	56,8	800	104,20

\*Aggiungere: Valvola mista o TR p.207 - Termostati p.208-209

L'essenzialità della piastra, in colori a scelta nella ampia gamma Brem, la praticità del

maniglione superiore completo di ganci portaccappatoi verniciati nel colore dello

*design Francesca Mocchi*  
scaldasalviette. A richiesta maniglioni cromati o verniciati in una tinta diversa dalla piastra.

## DIMENSIONI

Larghezze: 50,5 / 51,5 / 57,5 / 61,5 cm  
Altezze: 77 / 80 / 126 / 130 / 140 / 180 cm  
Profondità 11 cm  
Sporgenza dal muro 14 cm

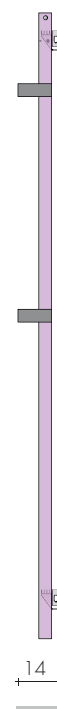
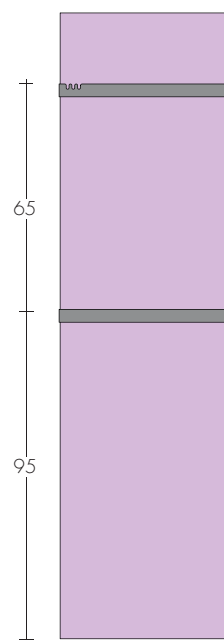
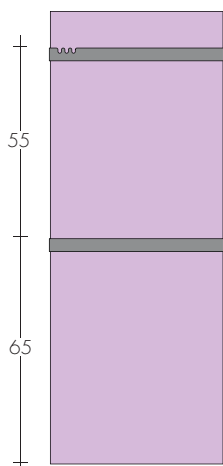
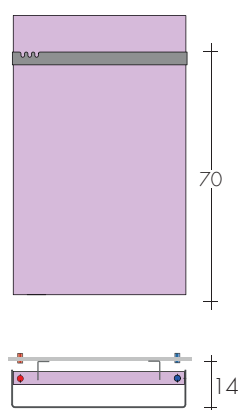

UNI-PLATT 80-49  
UNI-PLATT 77-50

UNI-PLATT 126-50/130-...  
UNI-PLATT 140-60

UNI-PLATT 180-...

MODELLO	HL cm	Bianco di serie sablé SB9016 €	EN 442			▲▼ int.att. cm	Altezza H cm	larghezza L cm	Peso M Kg	Volume V dm³	VERSIONI MISTE con Resistenza e *	
			Δt 50K watt	Δt 40K watt	Δt 30K watt						Watt	€
UNI-PLATT	80-49	637,40	388	290	199	45	80	50,5	12,1	3,4	-	-
UNI-PLATT	130-49	839,80	610	456	314	45	130	50,5	18,6	5,2	-	-
UNI-PLATT	130-56	905,00	697	521	358	52	130	57,5	21,3	5,9	-	-
UNI-PLATT	180-49	1016,00	817	611	420	45	180	50,5	25,4	7,0	-	-
UNI-PLATT	180-56	1094,30	934	699	480	52	180	57,5	29,1	8,0	-	-
UNI-PLATT	77-50	665,20	395	295	208	46,8	77	51,5	11,5	3,4	400	95,70
UNI-PLATT	126-50	911,90	614	459	323	46,8	126	51,5	18,9	5,6	650	99,80
UNI-PLATT	140-60	1050,60	810	606	416	56,8	140	61,5	25,1	6,7	800	104,20

► Pronta consegna

\*Aggiungere: Valvola mista o TR p.207  
Termostati p.208-209



Maniglione UNI di serie: - colore bianco SB9016  
- colore grigio SB7039 - colore nero sablé SB9005  
- nello stesso colore del radiatore ordinato



Maniglione UNI bianco supplementare cad. 66,40€  
Maniglione UNI in un colore, della tabella Brem,  
diverso dal radiatore Supplemento cad. 49,00€



Supplemento per maniglione cromato, cad. 78,70€  
Maniglione supplementare cromato cad.139,10€

## ESECUZIONI DI SERIE

Colore bianco sablé SB9016, mensola EOS  
PRESSIONE MASSIMA 6 bar - Sfiato ø 1/8"

## ESECUZIONI A RICHIESTA

Verniciatura in una tinta della tabella colori  
Brem con fissaggi colorati +15/25%

## ATTACCHI DI SERIE

EG ø 1/2"  
Versione elettrica, e.Uni-Platt p. 260



INTERASSE ATTACCHI

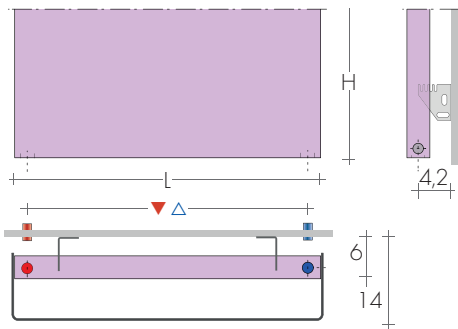

A richiesta attacchi laterali ▲▽ = H-3,2 cm  
Supplemento Art. AS 81,40€

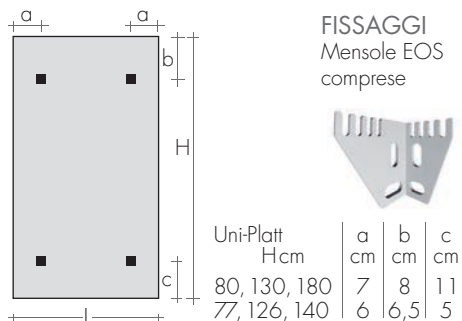

FISSAGGI  
Mensole EOS  
comprese



UNI-PLATT 130-49

VALVOLE CONSIGLIATE

KIT VALVOLE CROMATE comprende:

- n°2 Valvole con codoli
- n°2 Raccordi (per multistrato ø16 e rame ø12 e 14)
- n°2 Rosette tonde cromo ø 48, foro ø16

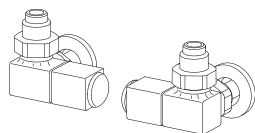

KIT VALVOLE QUADRA comando LATERALE  
pag. 271 Art. KQL 177,10€  
Colore tabella BREM supplemento 49,50€

FINITURE SPECIALI pag. 267  
Finiture Oro, Bronzo, Nickel spazzolato per 2 valvole  
KIT Raccordi NICKEL spazz. suppl. Art. RN 28,20€

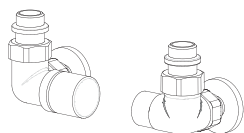

KIT VALVOLE CYL TERMOSTATIZZABILE comando LATERALE, pag.273 Art. KCL 150,50€  
Colore tabella BREM supplemento 49,50€

ATTACCHI REMOTI Art. REM 37,60€  
Interasse attacchi sul retro: ▲▽ EG  
Valvole REMOTE pag. 274

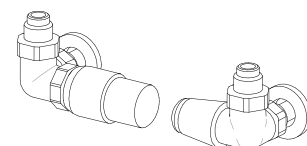
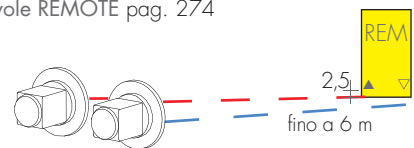

KIT VALVOLE TON comando LATERALE con testa TERMOSTATICA, pag. 269 Art. KTL 188,60€

design Davide Diliberto

Uno scaldasalviette con l'obiettivo di nascondere alla vista accappatoi e salviette

senza ricorrere ad ante o parti in movimento. La piastra è divisa in due da una piega netta,

creando un'ala che si allontana dal muro: una soluzione funzionale e semplice.

## DIMENSIONI

Larghezza 42 / 50 cm

Altezze 135 / 175 cm

Profondità: 15 / 19 / 21 cm

Sporgenza dal muro: 18,5 / 22,5 cm

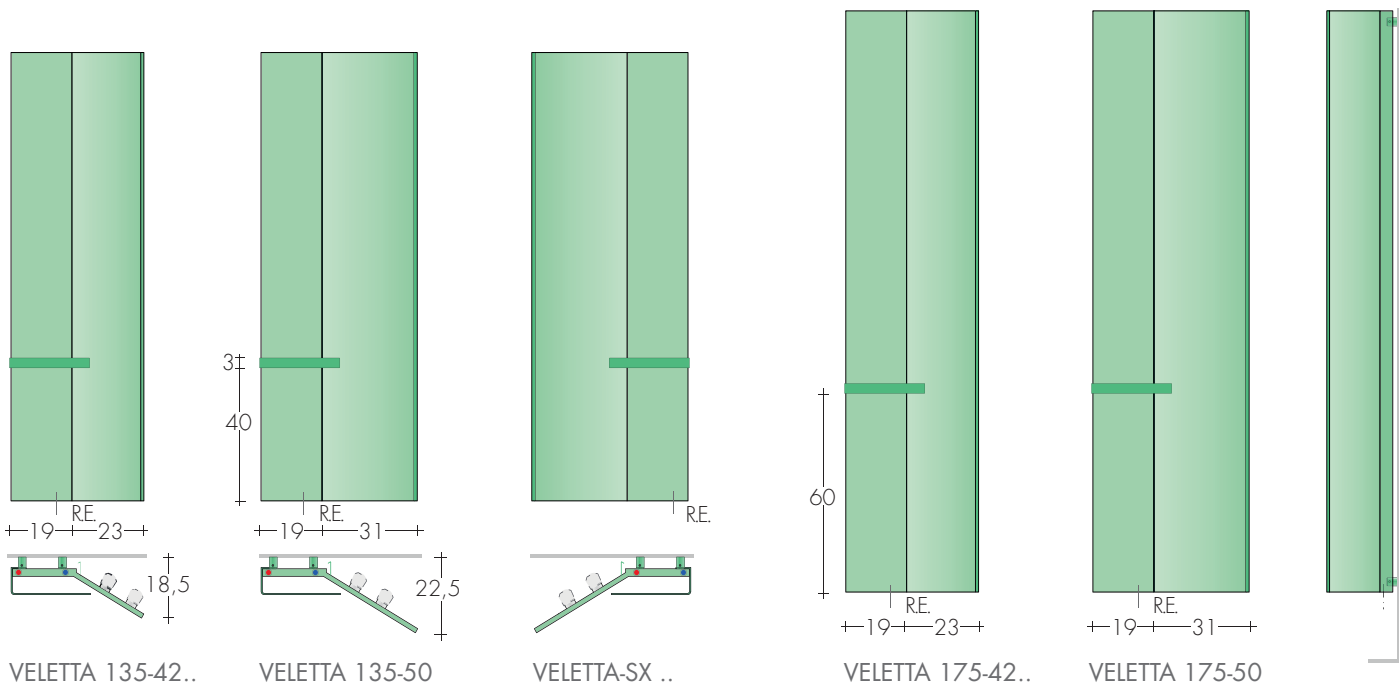

VELETTA 135-42..

VELETTA 135-50

VELETTA-SX ..

VELETTA 175-42..

VELETTA 175-50

## MODELLO

MODELLO	H-L cm	Bianco di serie sablé SB9016 €	$\Delta t$ 50K watt	EN 442		$\Delta t$ 30K watt	$\Delta t$ 40K watt	$\Delta t$ 30K watt	$\Delta t$ 40K watt	$\Delta t$ 50K watt	$\Delta t$ 30K watt	$\Delta t$ 40K watt	$\Delta t$ 50K watt	int.att. cm	Altezza H cm	Larghezza L cm	Peso M Kg	Volume V dm <sup>3</sup>	VERSIONI MISTE con Resistenza e manicotto		
				Watt	€																
VELETTA	135-42	1023,00	669	506	352	15	135	42	19,7	5,8	650	121,30									
VELETTA	135-50	1102,20	800	606	421	15	135	50	23,2	6,6	800	125,70									
VELETTA	175-42	1082,90	865	655	455	15	175	42	25,2	7,5	900	129,00									
VELETTA	175-50	1167,20	1033	782	543	15	175	50	29,7	8,5	900	129,00									
VELETTA-L	175-50	1403,20	1191	902	627	15	175	50	35,7	10,3	1200	136,70									

Versione SX, a richiesta senza supplemento

Termostati p.228-229

## MANIGLIONE VEL: COLORI DI SERIE

- bianco sablé SB 9016 - grigio sablé SB 7039  
- nero sablé SB 9005 - nel colore del radiatore

In un colore della tabella Brem diverso dallo scaldasalviette Supplemento 49,00€

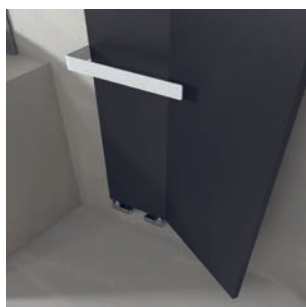

APPENDINI magnetici  
NON COMPRESI  
pag.277

Art. ARC / POC / HKC  
cad. 87,40€

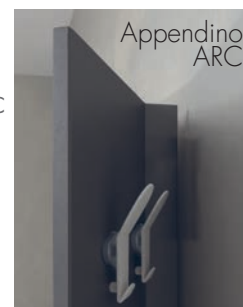

## ESECUZIONI DI SERIE

Colore bianco sablé SB9016, mensola B35  
Tolleranze  $\pm 3$ mm - Valvola di sfianto  $\varnothing 1/8$ "  
PRESSIONE MASSIMA D'ESERCIZIO 4 BAR

## ESECUZIONI A RICHIESTA

Verniciatura in una tinta della tabella colori  
Brem con fissaggi colorati +15/25%  
Versione elettrica e.Velett pag. 261

## ATTACCHI DI SERIE

EG  $\varnothing 3/8$ "  
A richiesta  $\varnothing 1/2$ " con manicotti  
Attacchi speciali pag.278



INTERASSE ATTACCHI EG Ø 3/8"

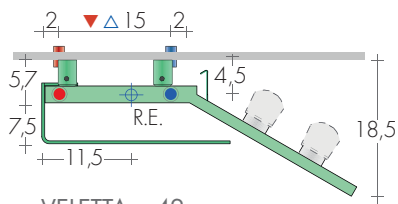

VELETTA ..-42

Appendini a richiesta

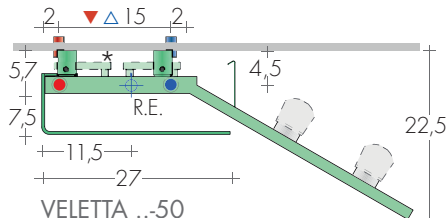

VELETTA ..-50

\*Modello ..L con tubi sul retro  
Versioni MISTE con manicotto per R.E., utilizzare valvole a squadra.



Attacchi Ø 3/8"  
DI SERIE  
(a filo piastra)



Attacchi Ø 1/2"  
A RICHIESTA  
(con manicotti)

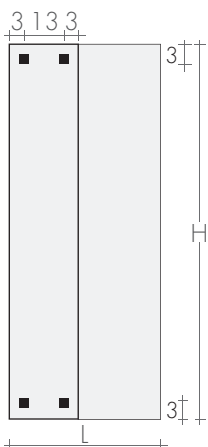

FISSAGGI  
Mensole comprese



Mensola B35



VELETTA 175-50

VALVOLE CONSIGLIATE

KIT VALVOLE CROMATE comprende:

- n°2 Valvole con codoli
- n°2 Raccordi (per multistrato Ø16 e rame Ø12 e 14)
- n°2 Rosette tonde cromo Ø 48, foro Ø16

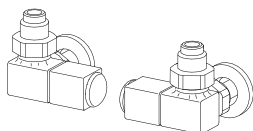

KIT VALVOLE QUADRA comando LATERALE  
pag. 271 Art. KQL 177,10€  
Colore tabella BREM supplemento 49,50€

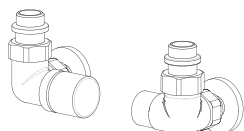

KIT VALVOLE CYL TERMOSTATIZZABILE comando LATERALE, pag.273 Art. KCL 150,50€  
Colore tabella BREM supplemento 49,50€

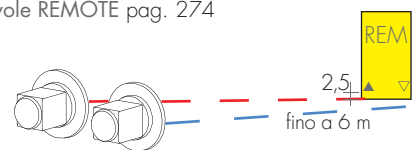

FINITURE SPECIALI pag. 267  
Finiture Oro, Bronzo, Nickel spazzolato per 2 valvole  
KIT Raccordi NICKEL spazz. suppl.Art. RN 28,20€

ATTACCHI REMOTI Art. REM 37,60€  
Interasse attacchi sul retro: ▲▼ 15 cm  
Valvole REMOTE pag. 274

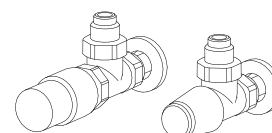

KIT VALVOLE TON a SQUADRA con Testa TERMO-STATICA, pag.269 Art. KTS 176,20€



# INDEX TubiDESIGN

CALORIFERI CON TUBI

## COLLEZIONE CALORIFERI

	pag.
CHEM	150
FORM	152
GRATA	156
RING	160
WIND	164

## COLLEZIONE SCALDASALVIETTE

	pag.
CANNUCCIA	168
CHEM-M	170
CHEM-S	172
FRAC	174
KUAD	176
MAHN	178
MAHN-AIR	180
PLANK	182
PLANK-AIR	184
PLUS 12	186
PLUS 18	188
PLUS-AIR	190
RAW	192
SHAR	196
SHAR-AIR	198
START	200
DIVIS	202



design Davide Diliberto

CHEM è un calorifero ad elementi realizzati in tubo tondo di 9 cm di diametro con la parte

terminale che curva verso la parete. È prodotto in varie altezze fino a 5 e 7 elementi e con

un tubo radiante sul retro; può essere integrato con elementi senza curva alti 96 cm.

## DIMENSIONI

Larghezze: da 9 a 93 cm

Altezze: 96,5 / 196 / 216 / 236 / 256 cm

Profondità: 18 cm

Sporgenza dal muro: 18 cm

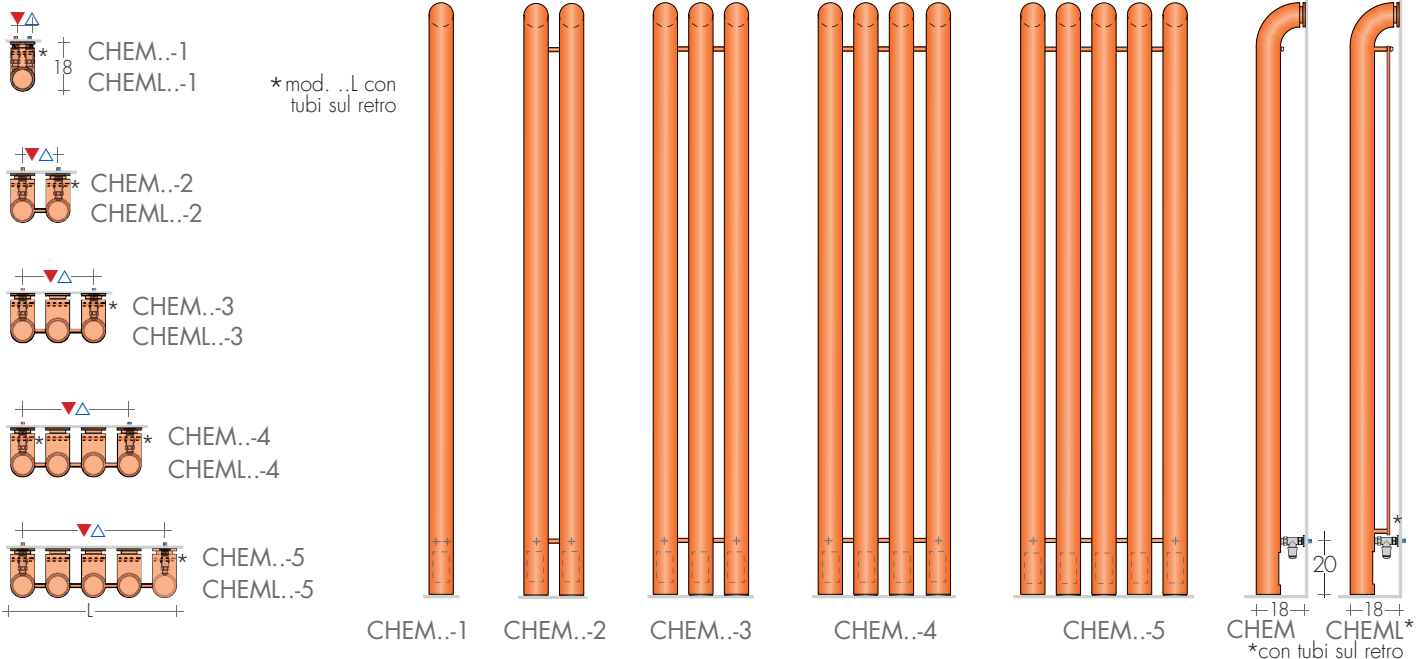

MODELLO	n°el.	1 el							2 el		3 el		4 el		5 el		6 el		7 el		
		H	L	cm	cm	cm	cm	cm	cm	cm	cm	cm	cm	cm	cm	cm	cm	cm	cm	cm	
CHEM 196	€	609,00	819,00	1029,00	1254,80	1480,50	326w	655w	984w	1313w	1642w	703,50	1008,00	1312,50	1632,80	1953,00	493w	989w	1485w	1981w	2477w
CHEML 196	€	703,50	1008,00	1312,50	1632,80	1953,00	493w	989w	1485w	1981w	2477w	739,20	1063,70	1388,10	1728,30	2068,50	555w	1113w	1671w	2229w	2787w
CHEM 216	€	640,50	866,30	1092,00	1333,50	1575,00	367w	737w	1107w	1477w	1847w	774,90	1119,30	1463,70	1823,90	2184,00	617w	1237w	1857w	2477w	3097w
CHEML 216	€	739,20	1063,70	1388,10	1728,30	2068,50	555w	1113w	1671w	2229w	2787w	774,90	1119,30	1463,70	1823,90	2184,00	617w	1237w	1857w	2477w	3097w
CHEM 236	€	672,00	913,50	1155,00	1412,30	1669,50	408w	819w	1230w	1641w	2052w	774,90	1119,30	1463,70	1823,90	2184,00	617w	1237w	1857w	2477w	3097w
CHEML 236	€	774,90	1119,30	1463,70	1823,90	2184,00	617w	1237w	1857w	2477w	3097w	774,90	1119,30	1463,70	1823,90	2184,00	617w	1237w	1857w	2477w	3097w
CHEM 256	€	703,50	960,80	1218,00	1491,00	1764,00	449w	901w	1353w	1805w	2257w	810,60	1175,00	1539,30	1919,40	2299,50	679w	1361w	2043w	2725w	3407w
CHEML 256	€	810,60	1175,00	1539,30	1919,40	2299,50	679w	1361w	2043w	2725w	3407w	304,50	409,50	514,50	624,80	735,00	138w	279w	420w	561w	702w
CHEM 96	€	304,50	409,50	514,50	624,80	735,00	138w	279w	420w	561w	702w	845,30	955,50	1305,20	1492,10	1317w	843w	984w			
CHEML 96	€	370,70	557,60	744,50	931,40	1118,30	217w	437w	657w	877w	1097w										

Gli elementi CHEM96 e CHEML96 possono essere aggiunti ai modelli alti. Lunghezza fino a 7 el.

Il prezzo si calcola sommando il costo dei 2 gruppi di elementi aggiungendo il prezzo della loro unione.

Unione CHEM 90,00€

Es. C..196-2 819,00€  
CHEM 96-3 514,50€  
Unione Chem 90,00€  
TOT. bianco 1423,50€

Altezze a richiesta.

Tolleranze ± 3mm

Valvola di sfiato ø 1/8"

## ESECUZIONI DI SERIE

Colore bianco sablé SB9016 mensole bianche

Pressione massima di esercizio: CHEM 8 BAR

CHEM con LAMELLE CHEML 4 BAR

## ESECUZIONI A RICHIESTA

Verniciatura in una tinta della tabella colori

Brem (con fissaggi colorati) +15/25%

Versione elettrica e.Chem pag.214

## ATTACCHI DI SERIE EG ø 1/2"

sul retro del tubo con valvole diritte.

Allacciamenti laterali con valvole a squadra a richiesta.



**INTERASSE ATTACCHI**

CHEM ..1 el. CHEM.. - da 2 a 7 elementi

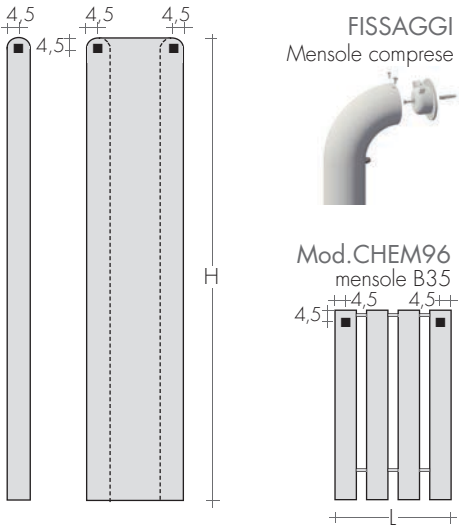
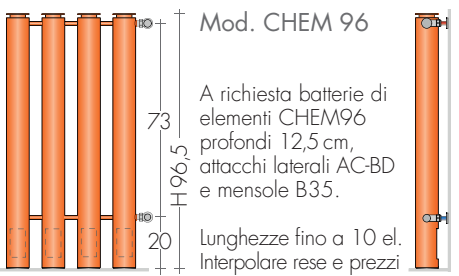
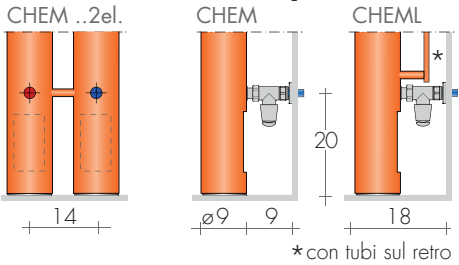
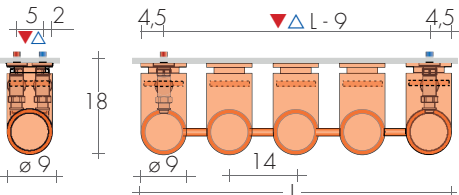

CHEM 216-3

TubiDESIGN

**VALVOLE CONSIGLIATE**

- KIT VALVOLE CROMATE comprende:
- n°2 Valvole con codoli
  - n°2 Raccordi (per multistrato ø16 e rame ø12 e 14)
  - n°2 Rosette tonde cromo ø 48, foro ø16

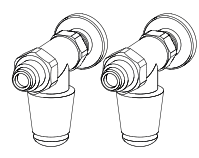

KIT VALVOLE TON DIRITTE pag. 269 Art. KVD 138,20€  
 KIT VALVOLE MINI DIRITTE cromo, pag.270 Art. KMD 126,70€

FINITURE SPECIALI pag. 267  
 Finiture Oro, Bronzo, Nickel spazzolato per 2 valvole  
 KIT Raccordi NICKEL spazz. suppl.Art. RN 28,20€

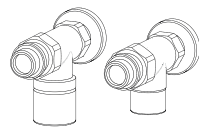

KIT VALVOLE CYL termostattabile DIRITTE pag. 273 Art. KCD 147,00€  
 Colore tabella BREM supplemento 49,50€

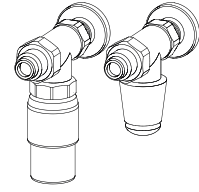

KIT VALVOLE TON DIRITTE con TESTA TERMO-STATICA, pag. 269 Art. KTD 187,50€

design Luigi Brebbia

FORM è un calorifero estremamente versatile ed elegante grazie alla forma particolare

dei collettori e alle dimensioni dei tubi radianti, decisamente ridotte ( $\varnothing 12$  mm).

Il numero accanto alla "F" indica il diverso interasse, in centimetri, fra i tubi radianti.

## MODELLO F...H

con tubi radianti verticali

H = da 60 a 300 cm (ogni 20 cm)

L = da 20 a 116 cm (ogni 6 cm)

Rinforzi metallici sul retro per altezze superiori a 80 cm.

F2H

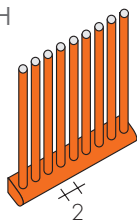

1 tubo ogni 2 cm

F3H

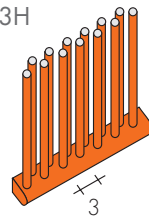

2 tubi ogni 3 cm

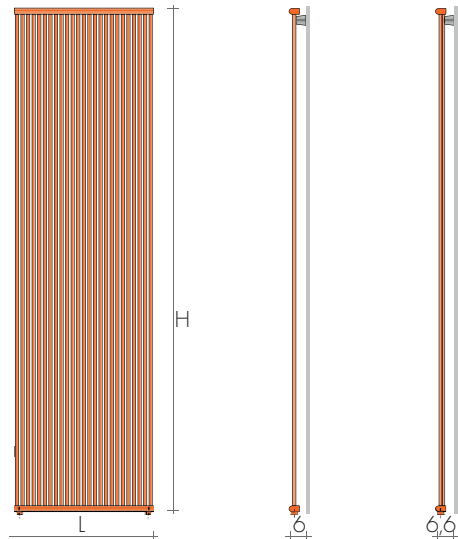

## MODELLO F...V

con tubi radianti orizzontali

H = da 20 a 116 cm (ogni 6 cm)

L = da 60 a 300 cm (ogni 20 cm)

Rinforzi metallici sul retro per lunghezze superiori a 80 cm.

F2V

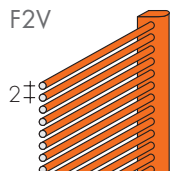

1 tubo ogni 2 cm

F3V

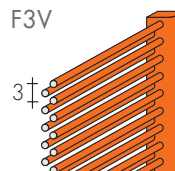

2 tubi ogni 3 cm

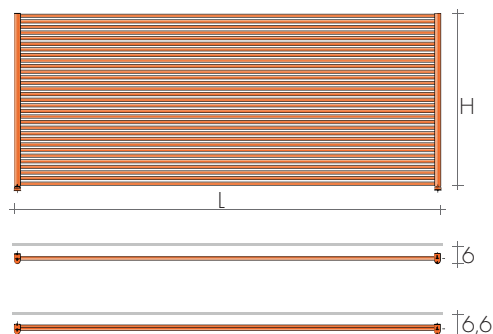

FORM F2V 62-280

## ESECUZIONI DI SERIE

Colore bianco sablé SB9016 mensole M4  
Tolleranze  $\pm 3$  mm - Valvola di sfiato  $\varnothing 1/8"$   
PRESSIONE MASSIMA D'ESERCIZIO 8 BAR

## ESECUZIONI A RICHIESTA

Verniciatura in una tinta della tabella colori  
Brem, con mensole M4 cromate +1,5/25%  
Dimensioni su misura, a preventivo

## ATTACCHI DI SERIE

EG  $\varnothing 1/2"$ . A richiesta  $3/8"$   
A richiesta attacchi AC o BD  
Attacchi speciali, pag. 278

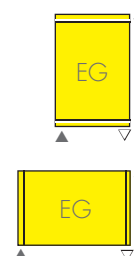

INTERASSE ATTACCHI

Attacchi di serie EG verticali, a richiesta attacchi laterali, senza supplemento

MODELLO FH

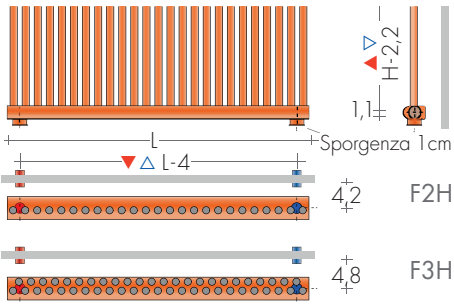

MODELLO FV

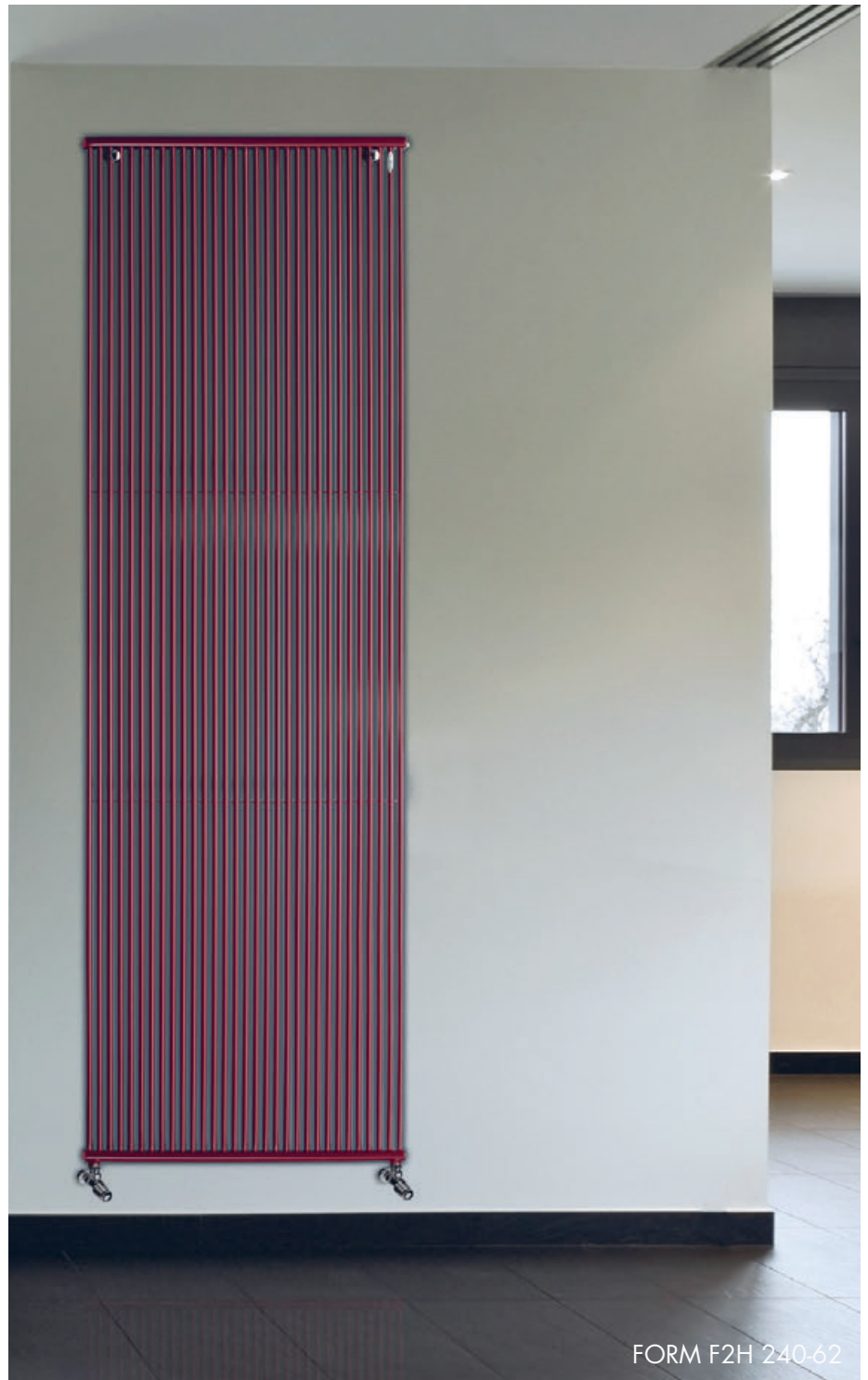
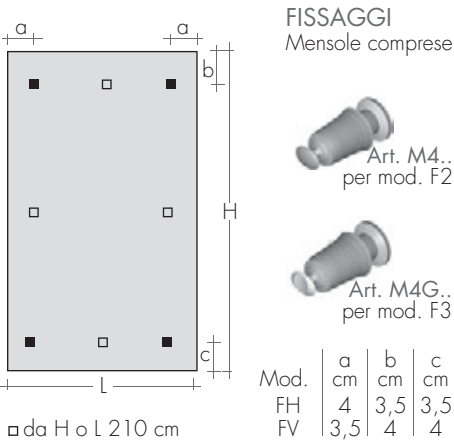
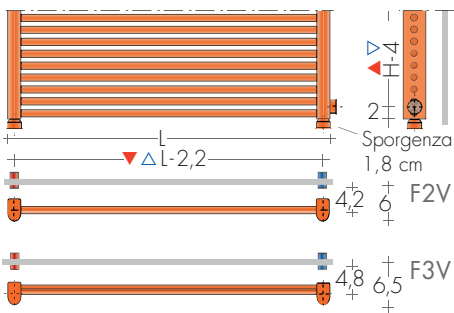

FORM F2H 240-62

VALVOLE CONSIGLIATE

KIT VALVOLE CROMATE comprende:

- n°2 Valvole con codoli
- n°2 Raccordi (per multistrato ø16 e rame ø12 e 14)
- n°2 Rosette tonde cromo ø 48, foro ø16

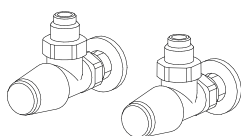

KIT VALVOLE TON A SQUADRA  
pag.269 Art. KVS 127,00€

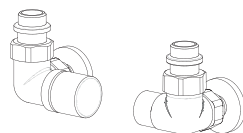

KIT VALVOLE CYL termostattabile con comando  
LATERALE, pag.273 Art. KCL 150,50€  
Colore tabella BREM supplemento 49,50€

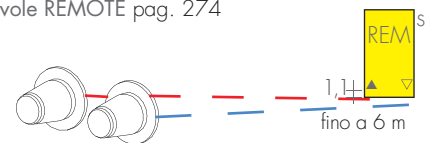

ATTACCHI REMOTI Art. REM 37,60€  
Interasse attacchi sul retro: ▲▼ EG  
Valvole REMOTE pag. 274

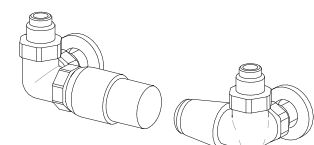

KIT VALVOLE TON comando LATERALE con testa  
TERMOSTATICA, pag. 269 Art. KTL 188,60€

# FORM F2H

PREZZI DAL 01.03.2026 +5%

MODELLO	L cm	20	26	32	38	44	50	56	62	68	74	80	86	92	98
H cm (n°tubi)		(10t)	(13t)	(16t)	(19t)	(22t)	(25t)	(28t)	(31t)	(34t)	(37t)	(40t)	(43t)	(46t)	(49t)
▲▼ cm		16	22	28	34	40	46	52	58	64	70	76	82	88	94
F2H 60	€	255,70 158w	289,90 206w	316,70 254w	342,00 302w	368,10 349w	399,40 397w	448,00 445w	499,90 492w	526,40 540w	547,60 588w	585,70 635w	621,20 683w	663,80 730w	703,60 778w
F2H 80	€	272,30 213w	305,70 276w	334,50 340w	363,10 404w	388,30 468w	421,50 532w	469,90 595w	527,30 659w	578,90 723w	632,00 787w	672,90 850w	714,60 914w	747,70 978w	783,10 1042w
F2H 100	€	279,10 266w	316,70 345w	345,20 425w	374,10 505w	401,60 584w	435,50 664w	489,60 744w	545,00 823w	596,70 903w	652,10 983w	708,30 1062w	761,00 1142w	814,10 1222w	869,40 1301w
F2H 120	€	297,80 317w	337,60 412w	367,40 508w	398,40 603w	426,00 698w	462,80 793w	519,90 888w	576,60 983w	635,40 1078w	692,80 1174w	750,10 1269w	808,80 1364w	864,80 1459w	924,20 1554w
F2H 140	€	320,10 368w	363,10 478w	395,90 588w	426,00 698w	460,10 809w	495,30 919w	556,90 1029w	619,90 1140w	680,50 1250w	743,80 1360w	806,30 1470w	867,10 1581w	929,70 1691w	992,50 1801w
F2H 160	€	360,80 417w	407,00 542w	443,30 667w	480,10 792w	515,10 917w	556,90 1042w	626,70 1166w	696,00 1291w	764,70 1416w	832,90 1541w	904,30 1666w	975,10 1791w	1043,50 1916w	1113,90 2041w
F2H 180	€	398,40 464w	448,70 603w	488,70 742w	529,60 882w	571,50 1021w	617,40 1160w	693,60 1299w	771,10 1438w	848,40 1578w	925,60 1717w	1001,90 1856w	1079,80 1995w	1157,30 2134w	1233,20 2274w
F2H 190	€	417,30 486w	470,70 632w	512,80 778w	555,10 923w	596,70 1069w	647,40 1215w	725,90 1361w	808,80 1507w	888,00 1652w	968,90 1798w	1051,20 1944w	1130,70 2090w	1209,90 2236w	1292,00 2381w
F2H 200	€	435,50 510w	490,80 663w	536,20 816w	580,40 969w	623,60 1122w	676,10 1275w	759,80 1427w	844,10 1580w	928,10 1733w	1012,40 1886w	1097,80 2039w	1182,40 2192w	1266,40 2345w	1347,90 2498w
F2H 210	€	452,60 532w	511,90 692w	556,90 852w	605,40 1012w	649,80 1171w	703,60 1331w	790,80 1491w	880,10 1650w	966,60 1810w	1054,60 1970w	1141,50 2130w	1230,00 2289w	1316,90 2449w	1404,40 2609w
F2H 220	€	469,90 554w	533,10 720w	578,90 887w	627,90 1053w	675,50 1219w	731,20 1386w	822,90 1552w	913,50 1718w	1001,90 1884w	1095,30 2051w	1187,00 2217w	1277,40 2383w	1369,80 2549w	1460,40 2716w
F2H 240	€	506,30 597w	572,50 776w	622,20 955w	673,90 1134w	724,80 1313w	785,50 1493w	882,70 1672w	978,30 1851w	1075,60 2030w	1173,70 2209w	1272,70 2388w	1369,80 2567w	1468,50 2746w	1566,50 2925w
F2H 260	€	553,70 638w	626,70 830w	681,90 1021w	738,90 1213w	794,20 1404w	860,50 1596w	965,00 1788w	1071,10 1979w	1178,00 2171w	1311,60 2362w	1394,20 2554w	1501,10 2745w	1607,20 2937w	1714,10 3128w
F2H 280	€	602,40 678w	680,50 881w	742,20 1085w	803,00 1288w	863,70 1492w	934,50 1695w	1052,10 1898w	1165,70 2102w	1282,40 2305w	1427,20 2509w	1519,10 2712w	1635,80 2915w	1750,40 3119w	1866,30 3322w
F2H 300	€	654,30 716w	741,40 931w	807,50 1146w	872,40 1361w	938,90 1576w	1016,90 1791w	1143,00 2005w	1269,50 2220w	1396,50 2435w	1552,10 2650w	1651,30 2865w	1779,30 3080w	1904,70 3295w	2031,80 3509w

Δt diversi da 50 K: consultare Dati tecnici Brem

ORDINE Indicare: il modello con altezza e larghezza in cm; l'allacciamento e il colore, solo se diversi dalla esecuzione di serie.

Mod. Form passo 2 cm collettore orizzontale altezza cm lunghezza cm

F2H 200 - 50

Es.: F2H 200-50, AC ø 3/8", RAL 3003

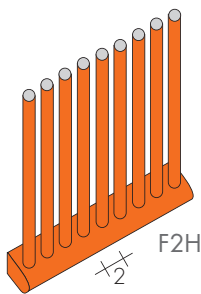

## FORM ONDULATO

MOD.	L cm	32	38	44	50	56	62	68	74	80
H cm (n°tubi)		(16t)	(19t)	(22t)	(25t)	(28t)	(31t)	(34t)	(37t)	(40t)
▲▼ cm		28	34	40	46	52	58	64	70	76
FO 180	€	772,10 742w	811,80 882w	862,70 1021w	907,80 1160w	994,00 1299w	1067,50 1438w	1153,00 1578w	1228,40 1717w	1314,40 1856w
FO 190	€	807,60 778w	848,30 923w	887,90 1069w	948,50 1215w	1024,30 1361w	1115,20 1507w	1193,00 1652w	1281,30 1798w	1361,70 1944w
FO 200	€	840,50 816w	872,40 969w	925,50 1122w	975,90 1275w	1068,40 1427w	1150,20 1580w	1242,80 1733w	1323,10 1886w	1406,60 2039w
FO 210	€	861,40 852w	907,80 1012w	950,50 1171w	1014,50 1331w	1099,40 1491w	1196,30 1650w	1279,00 1810w	1363,80 1970w	1449,80 2130w
FO 220	€	882,50 887w	929,60 1053w	987,10 1219w	1041,00 1386w	1140,10 1552w	1228,40 1718w	1314,40 1884w	1404,80 2051w	1492,70 2217w

A richiesta FORM ONDULATO è curvato su misura: allegare disegno quotato per preventivo.

Mensole M4F..

9/12cm

# FORM F2V

PREZZI DAL 01.03.2026 +5%

EN 442 Watt  $\Delta t$  50K ( $\Delta t$  40K =  $W \times 0,755$ ) - ( $\Delta t$  30K =  $W \times 0,526$ )

MODELLO (n° tubi)	L cm ▲ ▼ cm	Lunghezze												
		60	80	100	120	140	160	180	200	220	240	260	280	300
F2V 20 (10t)	€	255,70 156w	272,30 208w	279,10 260w	297,80 312w	320,10 364w	360,80 416w	398,40 468w	435,50 520w	469,90 572w	506,30 624w	553,70 676w	602,40 728w	654,30 780w
F2V 26 (13t)	€	289,90 203w	305,70 270w	316,70 338w	337,60 406w	363,10 473w	407,00 541w	448,70 608w	490,80 676w	533,10 744w	572,50 811w	626,70 879w	680,50 946w	741,40 1014w
F2V 32 (16t)	€	316,70 250w	334,50 334w	345,20 417w	367,40 500w	395,90 584w	443,30 667w	488,70 751w	536,20 834w	578,90 917w	622,20 1001w	681,90 1084w	742,20 1168w	807,50 1251w
F2V 38 (19t)	€	342,00 298w	363,10 397w	374,10 496w	398,40 595w	426,00 694w	480,10 794w	529,60 893w	580,40 992w	627,90 1091w	673,90 1190w	738,90 1290w	803,00 1389w	872,40 1488w
F2V 44 (22t)	€	368,10 344w	388,30 459w	401,60 574w	426,00 689w	460,10 804w	515,10 918w	571,50 1033w	623,60 1148w	675,50 1263w	724,80 1378w	794,20 1492w	863,70 1607w	938,90 1722w
F2V 50 (25t)	€	399,40 397w	421,50 529w	435,50 661w	462,80 793w	495,30 925w	556,90 1058w	617,40 1190w	676,10 1322w	731,20 1454w	785,50 1586w	860,50 1719w	934,50 1851w	1016,90 1983w
F2V 56 (28t)	€	436,60 445w	447,10 593w	489,60 741w	519,90 889w	556,90 1037w	626,70 1186w	693,60 1334w	759,80 1482w	822,90 1630w	882,70 1778w	965,00 1927w	1052,10 2075w	1143,00 2223w
F2V 62 (31t)	€	499,90 494w	527,30 658w	545,00 823w	576,60 988w	619,90 1152w	696,00 1317w	771,10 1481w	844,10 1646w	913,50 1811,00	978,30 1975w	1071,10 2140w	1165,70 2304w	1269,50 2469w
F2V 68 (34t)	€	526,40 541w	578,90 722w	596,70 902w	635,40 1082w	680,50 1263w	764,70 1443w	848,40 1624w	928,10 1804w	1001,90 1984w	1075,60 2165w	1178,00 2345w	1282,40 2526w	1396,50 2706w
F2V 74 (37t)	€	547,60 590w	632,00 786w	652,10 983w	692,80 1180w	743,80 1376w	832,90 1573w	925,60 1769w	1012,40 1966w	1095,30 2163w	1173,70 2359w	1311,60 2556w	1427,20 2752w	1552,10 2949w
F2V 80 (40t)	€	585,70 638w	672,90 850w	708,30 1063w	750,10 1276w	806,30 1488w	904,30 1701w	1001,90 1913w	1097,80 2126w	1187,00 2339w	1272,70 2551w	1394,20 2764w	1519,10 2976w	1651,30 3189w
F2V 86 (43t)	€	621,20 686w	714,60 914w	761,00 1143w	808,80 1372w	867,10 1600w	975,10 1829w	1079,80 2057w	1182,40 2286w	1277,40 2515w	1369,80 2743w	1501,10 2972w	1635,80 3200w	1779,30 3429w
F2V 92 (46t)	€	663,80 733w	747,70 978w	814,10 1222w	864,80 1466w	929,70 1711w	1043,50 1955w	1157,30 2200w	1266,40 2444w	1369,80 2688w	1468,50 2933w	1607,20 3177w	1750,40 3422w	1904,70 3666w
F2V 98 (49t)	€	703,60 781w	783,10 1042w	869,40 1302w	924,20 1562w	992,50 1823w	1113,90 2083w	1233,20 2344w	1347,90 2604w	1460,40 2864w	1566,50 3125w	1714,10 3385w	1866,30 3646w	2031,80 3906w
F2V 104 (52t)	€	735,80 829w	816,30 1105w	905,50 1381w	980,60 1657w	1054,60 1933w	1184,00 2210w	1309,50 2486w	1435,10 2762w	1551,00 3038w	1664,10 3314w	1822,20 3591w	1984,60 3867w	2157,30 4143w
F2V 110 (55t)	€	768,80 877w	849,60 1169w	944,20 1461w	1038,80 1753w	1117,80 2045w	1252,90 2338w	1388,60 2630w	1519,10 2922w	1643,30 3214w	1761,60 3506w	1929,60 3799w	2101,60 4091w	2286,70 4383w
F2V 116 (58t)	€	801,00 925w	884,50 1233w	994,00 1541w	1098,50 1849w	1178,00 2157w	1322,70 2466w	1466,00 2774w	1605,00 3082w	1736,40 3390w	1860,90 3698w	2039,50 4007w	2220,20 4315w	2413,50 4623w

$\Delta t$  diversi da 50 K: consultare Dati tecnici Brem

## ESECUZIONI A RICHIESTA

Rese caloriche e prezzi per interpolazione:

- lunghezze collettori ogni 2 cm
- altezze tubi radianti ogni 10 cm

Esecuzioni su misura ( $\pm 3$  mm)

Dimensioni oltre 3 m: a preventivo

Misure ogni 1 cm: misura superiore +20%

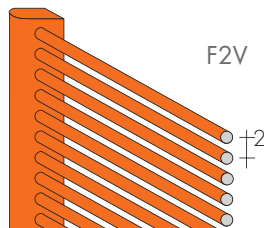

F2V



**VERSIONE DOPPIA FDH e FDV**  
Si uniscono due caloriferi F2H o F2V  
PREZZI F2H o F2V x 2 + 120,20€  
RESE FD.. - F2H o F2V x 1,60

Attacco di serie EG:  
mandata sulla parte anteriore sinistra  
ritorno sulla parte posteriore destra

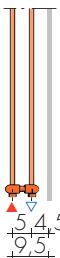

FORM DIVIS può essere realizzato come:

- divisorio con piedini e fissaggi pag. 276
- piedino H di serie 15cm Art. PF15 78,50€
- fissaggio laterale Art. F10 74,90€

FORM F3H e F3V è realizzato nel passo di 3 cm con un tubo alternato sul retro

- dimensioni come F2 ogni 6 cm
- RESE watt F2 x 1,16 - PREZZI € F2 x 1,40

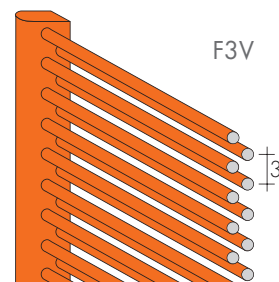

F3V

*design Luigi Brembilla*

GRATA è un calorifero dalle alte rese caloriche e dalla forte caratterizzazione

estetica grazie al design che ha voluto incrociare tubi radianti di minime dimensioni

con lamelle d'acciaio. Da questo assieme scaturisce una forma con grande effetto.

## MODELLO GRH

con tubi radianti verticali

H = da 60 a 300 cm (ogni 20 cm)  
Altezze a richiesta ogni 5 cm

L = da 20 a 110 cm (ogni 6 cm)  
Larghezze a richiesta ogni 3 cm

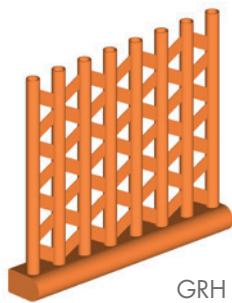

GRH

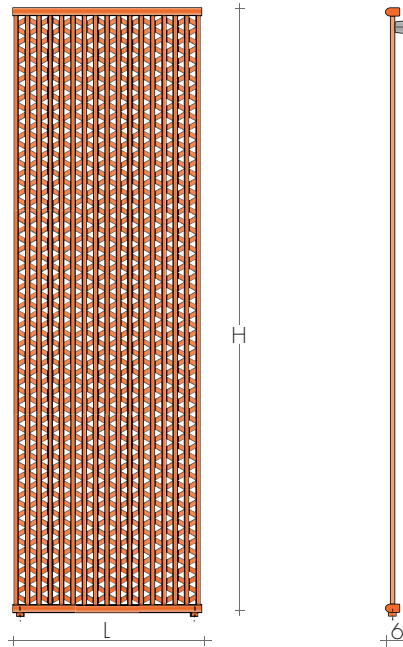

## MODELLO GRV

con tubi radianti orizzontali

H = da 20 a 116 cm (ogni 6 cm)  
Altezze a richiesta ogni 3 cm

L = da 60 a 300 cm (ogni 20 cm)  
Lunghezze a richiesta ogni 5 cm

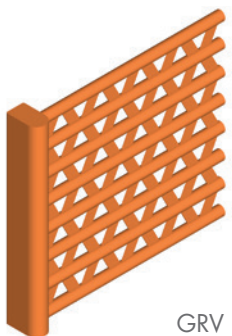

GRV

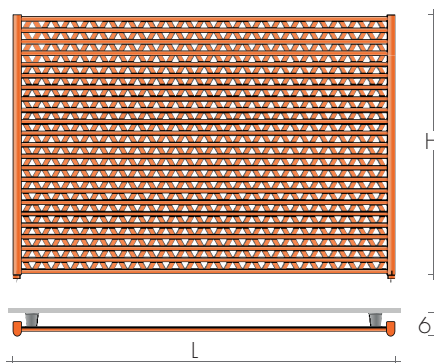

### ESECUZIONI DI SERIE

Colore bianco sablé SB9016, mensole M4GB  
Valvola di sfiato  $\varnothing$  1/8" - Tolleranze  $\pm$  3mm  
PRESSIONE MASSIMA D'ESERCIZIO 8 BAR

### ESECUZIONI A RICHIESTA

Verniciatura tabella colori Brem  
(con mensole cromate M4GC) +15./25%  
Dimensioni su misura, a preventivo

### ATTACCHI DI SERIE

EG  $\varnothing$  1/2". A richiesta 3/8"  
A richiesta attacchi AC o BD  
Attacchi speciali, pag. 278

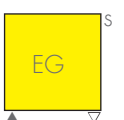

**INTERASSE ATTACCHI**

Attacchi di serie EG verticali  
A richiesta attacchi laterali senza supplemento

**MODELLO GRH**

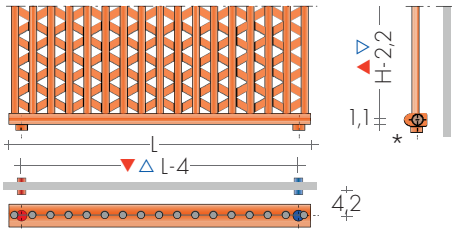

**MODELLO GRV**

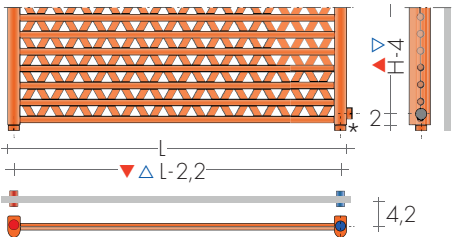

\* Sporgenza manicotti 1 cm

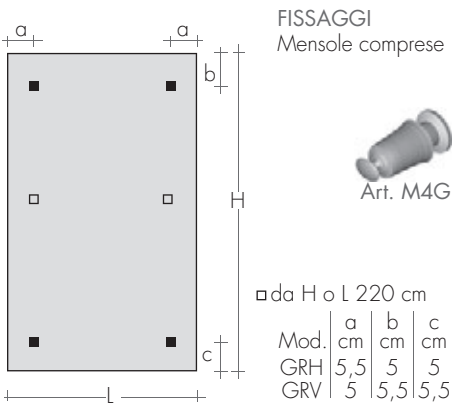

GRATA GRH 200-50

**VALVOLE CONSIGLIATE**

**KIT VALVOLE CROMATE** comprende:

- n°2 Valvole con codoli
- n°2 Raccordi (per multistrato ø16 e rame ø12 e 14)
- n°2 Rosette tonde cromo ø 48, foro ø16

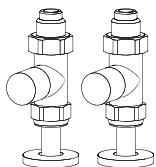

**KIT VALVOLE MINI DIRITTE**  
cromo pag.270 Art. KMD 126,70€

**FINITURE SPECIALI**

pag. 267  
Finiture Oro, Bronzo, Nickel spazzolato per 2 valvole  
KIT Raccordi NICKEL spazz. suppl.Art. RN 28,20€

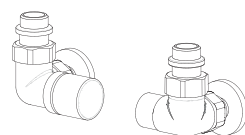

**KIT VALVOLE CYL** termostattabile con comando  
LATERALE, pag.273 Art. KCL 150,50€  
Colore tabella BREM supplemento 49,50€

**ATTACCHI REMOTI**

Art. REM 37,60€  
Interasse attacchi sul retro: ▲▼ EG  
Valvole REMOTE pag. 274

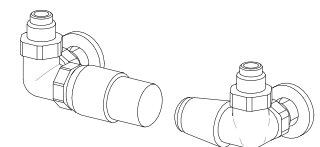
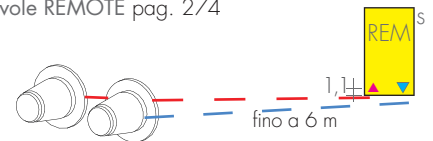

**KIT VALVOLE TON** comando LATERALE con testa  
TERMOSTATICA, pag. 269 Art. KTL 188,60€

# GRATA GRH

PREZZI DAL 01.03.2026 +5%

EN 442 Watt  $\Delta t$  50K ( $\Delta t$  40K =  $W \times 0,755$ ) - ( $\Delta t$  30K =  $W \times 0,526$ )

MOD. H cm	Lunghezze															
	L cm	20	26	32	38	44	50	56	62	68	74	80	86	92	98	104
▲▼ cm	16	22	28	34	40	46	52	58	64	70	76	82	88	94	100	
GRH 60 €	491,90 146w	553,00 190w	604,60 234w	653,40 278w	703,70 322w	763,20 366w	833,70 410w	952,60 454w	1052,3 498w	1156,6 542w	1252,0 586w	1350,5 630w	1451,5 673w	1547,9 717w	1661,0 761w	
GRH 80 €	521,00 187w	586,30 243w	638,40 299w	693,00 355w	742,7 411w	807,5 468w	854,9 524w	1008,3 580w	1108,2 636w	1210,1 692w	1309,8 748w	1410,5 804w	1493,5 860w	1612,7 916w	1719,6 972w	
GRH 100 €	534,30 229w	604,60 297w	661,20 366w	714,60 435w	767,8 503w	831,1 572w	938,0 641w	1040,9 709w	1141,1 778w	1245,5 847w	1352,7 915w	1454,7 984w	1556,9 1052w	1661,0 1121w	1763,6 1190w	
GRH 120 €	567,80 268w	644,10 348w	703,10 429w	760,50 509w	816,4 590w	884,4 670w	994,5 750w	1102,2 831w	1215,4 911w	1325,5 992w	1435,8 1072w	1545,7 1152w	1655,7 1233w	1765,6 1313w	1875,4 1394w	
GRH 140 €	612,30 308w	693,00 400w	755,30 492w	816,40 585w	878,5 677w	950,1 770w	1067,3 862w	1186,1 954w	1303,1 1047w	1420,9 1139w	1541,1 1231w	1659,3 1324w	1780,0 1416w	1898,4 1508w	2015,0 1601w	
GRH 160 €	688,60 346w	777,80 449w	848,20 553w	914,80 657w	985,4 760w	1067,3 864w	1197,6 968w	1331,3 1071w	1462,5 1175w	1593,2 1279w	1729,5 1382w	1865,4 1486w	1998,2 1590w	2127,1 1693w	2262,5 1797w	
GRH 180 €	760,50 383w	858,30 497w	935,30 612w	1014,6 727w	1090,7 842w	1181,8 957w	1328,0 1071w	1475,4 1186w	1620,4 1301w	1768,0 1416w	1917,5 1530w	2063,9 1645w	2212,5 1760w	2358,4 1875w	2502,5 1990w	
GRH 190 €	794,90 404w	900,70 525w	979,70 647w	1062,4 758w	1141,8 889w	1237,4 1011w	1388,7 1132w	1544,6 1253w	1696,3 1374w	1852,0 1496w	2008,4 1617w	2161,4 1738w	2316,7 1859w	2468,4 1981w	2622,7 2102w	
GRH 200 €	831,10 419w	941,20 545w	1024,9 671w	1111,2 796w	1194,1 922w	1292,7 1048w	1452,8 1174w	1613,3 1300w	1772,6 1425w	1934,7 1551w	2099,2 1677w	2259,9 1803w	2420,8 1928w	2576,8 2054w	2743,2 2180w	
GRH 210 €	863,8 429w	978,4 557w	1067,3 686w	1155,8 815w	1241,8 943w	1346,1 1072w	1513,1 1201w	1680,8 1329w	1846,0 1458w	2015,0 1587w	2183,8 1715w	2351,6 1844w	2521,1 1972w	2684,3 2101w	2855,3 2230w	
GRH 220 €	899,7 453w	1018,2 589w	1108,2 724w	1199,4 860w	1290,3 996w	1398,2 1132w	1571,4 1268w	1746,6 1404w	1917,5 1540w	2093,6 1675w	2267,8 1811w	2444,0 1947w	2618,5 2083w	2790,8 2219w	2966,7 2355w	
GRH 240 €	966,5 486w	1093,5 632w	1190,6 777w	1288,1 923w	1387,1 1069w	1501,2 1215w	1686,4 1360w	1871,1 1506w	2057,1 1652w	2245,3 1797w	2434,4 1943w	2618,5 2089w	2808,8 2235w	2995,3 2380w	3180,7 2526w	
GRH 260 €	1060,2 517w	1197,6 672w	1305,0 827w	1412,1 982w	1519,4 1137w	1645,7 1293w	1844,0 1448w	2047,8 1603w	2252,0 1758w	2507,5 1913w	2664,8 2068w	2871,4 2223w	3073,2 2378w	3278,1 2533w	3484,0 2688w	
GRH 280 €	1152,0 548w	1303,1 712w	1418,6 877w	1537,6 1041w	1652,0 1206w	1788,2 1370w	2010,5 1534w	2229,7 1699w	2455,0 1863w	2728,3 2028w	2902,9 2192w	3127,3 2356w	3346,2 2521w	3568,8 2685w	3792,2 2850w	
GRH 300 €	1252,0 577w	1415,3 750w	1543,2 923w	1669,3 1096w	1796,6 1269w	1943,9 1443w	2186,1 1616w	2426,9 1789w	2670,5 1962w	2969,0 2135w	3159,3 2308w	3402,0 2481w	3641,3 2654w	3883,8 2827w	4124,6 3000w	

$\Delta t$  diversi da 50 K: consultare Dati tecnici Brem

## ORDINE

Indicare: il modello con altezza e larghezza in cm; l'attacco e il colore, solo se diversi dalla esecuzione di serie.

es.: GRH 180 - 38, AC  $\varnothing$  3/8", SB 2008

Mod. Grata      collettore orizzontale      altezza cm      lunghezza cm

GRH 200 - 50

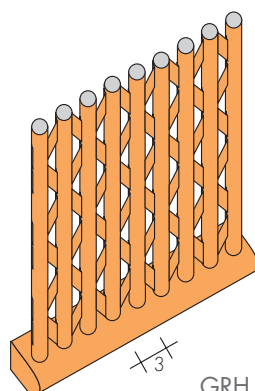

GRH

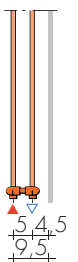

## VERSIONE DOPPIA GDH

Si uniscono due grate GRH

PREZZO GDH GRH x 2 + 120,20€

Attacco di serie EG (mandata sulla parte anteriore sinistra, ritorno sulla posteriore destra).  
Rese indicative GDH: radiatore singolo x1,60

## ESECUZIONI A RICHIESTA

Rese caloriche e prezzi per interpolazione:

- lunghezze collettori ogni 3 cm
- altezze tubi radianti ogni 10 cm

Esecuzioni su misura ( $\pm 3$  mm)

Dimensioni oltre 3 m: a preventivo

Altezze ogni 5 cm: misura superiore +15%

EN 442 Watt  $\Delta t$  50K ( $\Delta t$  40K =  $W \times 0,755$ ) - ( $\Delta t$  30K =  $W \times 0,526$ )

MOD.	L cm ▲▼ cm	Lunghezze												
		60	80	100	120	140	160	180	200	220	240	260	280	300
GRV 20	€	491,90 131w	521,00 174 w	534,30 218w	567,80 262w	612,30 305w	688,60 349w	760,50 392w	831,10 436w	899,70 480w	966,50 523w	1060,2 567w	1152,0 610w	1252,0 654w
GRV 26	€	553,00 172w	586,30 229w	604,60 286w	644,10 343w	693,00 400w	777,80 458w	858,30 515w	941,20 572w	1018,2 629w	1093,5 686w	1197,6 744w	1303,1 801w	1415,3 858w
GRV 32	€	604,60 212w	638,40 283w	661,20 354w	703,10 425w	755,30 496w	848,20 566w	935,30 637w	1024,9 708w	1108,2 779w	1190,6 850w	1305,0 920w	1418,6 991w	1543,2 1062w
GRV 38	€	653,40 254w	693,00 338w	714,60 423w	760,50 508w	816,40 592w	914,80 677w	1014,6 761w	1111,2 846w	1199,4 931w	1288,1 1015w	1412,1 1100w	1537,6 1184w	1669,3 1269w
GRV 44	€	703,70 295w	742,70 393w	767,80 491w	816,40 589w	878,50 687w	985,40 786w	1090,7 884w	1194,1 982w	1290,3 1080w	1387,1 1178w	1519,4 1277w	1652,0 1375w	1796,6 1473w
GRV 50	€	763,20 336w	807,50 448w	831,10 560w	884,40 672w	950,10 784w	1067,3 896w	1181,8 1008w	1292,7 1120w	1398,2 1232w	1501,2 1344w	1645,7 1456w	1788,2 1568w	1943,9 1680w
GRV 56	€	833,70 377w	854,90 503w	938,00 629w	994,50 755w	1067,3 881w	1197,6 1006w	1328,0 1132w	1452,8 1258w	1571,4 1384w	1686,4 1510w	1844,0 1635w	2010,5 1761w	2186,1 1887w
GRV 62	€	952,60 420w	1008,30 560w	1040,9 700w	1102,2 840w	1186,1 980w	1331,3 1120w	1475,4 1260w	1613,3 1400w	1746,6 1540w	1871,1 1680w	2047,8 1820w	2229,7 1960w	2426,9 2100w
GRV 68	€	1052,3 461w	1108,2 615w	1141,1 769w	1215,4 923w	1303,1 1077w	1462,5 1230w	1620,4 1384w	1772,6 1538w	1917,5 1692w	2057,1 1846w	2252,0 1999w	2455,0 2153w	2670,5 2307w
GRV 74	€	1156,6 503w	1210,1 670w	1245,5 838w	1325,5 1006w	1420,9 1173w	1593,2 1341w	1768,0 1508w	1934,7 1676w	2093,6 1844w	2245,3 2011w	2507,5 2179w	2728,3 2346w	2969,0 2514w
GRV 80	€	1252,0 545w	1309,8 726w	1352,7 908w	1435,8 1090w	1541,1 1271w	1729,5 1453w	1917,5 1634w	2099,2 1816w	2267,8 1998w	2434,4 2179w	2664,8 2361w	2902,9 2542w	3159,3 2724w
GRV 86	€	1350,5 586w	1410,5 782w	1454,7 977w	1545,7 1172w	1659,3 1368w	1865,4 1563w	2063,9 1759w	2259,9 1954w	2444,0 2149w	2618,5 2345w	2871,4 2540w	3127,3 2736w	3402,0 2931w
GRV 92	€	1451,5 628w	1493,5 837w	1556,9 1046w	1655,7 1255w	1780,0 1464w	1998,2 1674w	2212,5 1883w	2420,8 2092w	2618,5 2301w	2808,8 2510w	3073,2 2720w	3346,2 2929w	3641,3 3138w
GRV 98	€	1547,9 669w	1612,7 892w	1661,0 1115w	1765,6 1338w	1898,4 1561w	2127,1 1784w	2358,4 2007w	2576,8 2230w	2790,8 2453w	2995,3 2676w	3278,1 2899w	3568,8 3122w	3883,8 3345w
GRV 104	€	1661,0 710w	1719,6 947w	1763,6 1184w	1875,4 1421w	2015,0 1658w	2262,5 1894w	2502,5 2131w	2743,2 2368w	2966,7 2605w	3180,7 2842w	3484,0 3078w	3792,2 3315w	4124,6 3552w
GRV 110	€	1757,9 752w	1810,1 1002w	1854,1 1253w	1985,2 1504w	2136,6 1754w	2396,3 2005w	2652,3 2255w	2902,9 2506w	3141,3 2757w	3371,4 3007w	3691,6 3258w	4018,6 3508w	4371,3 3759w
GRV 116	€	1856,2 793w	1910,8 1058w	1966,1 1322w	2102,6 1586w	2252,0 1851w	2529,0 2115w	2804,1 2380w	3068,7 2644w	3318,3 2908w	3561,0 3173w	3899,5 3437w	4244,6 3702w	4616,4 3966w

$\Delta t$  diversi da 50 K: consultare Dati tecnici Brem



### ESECUZIONI A RICHIESTA

Rese caloriche e prezzi per interpolazione:  
 - altezze collettori ogni 3 cm  
 - lunghezze tubi radianti ogni 10 cm

Esecuzioni su misura ( $\pm 3$  mm)

Dimensioni oltre 3 m: a preventivo  
 Misure ogni 5 cm: misura superiore +15%

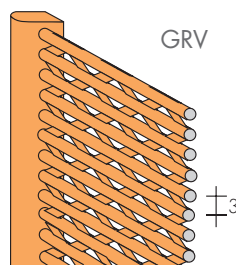

### VERSIONE DOPPIA GDV

Si uniscono due caloriferi GRV

PREZZO GDV    GRV x 2 + 120,20€

Attacco di serie EG (mandata sulla parte anteriore sinistra, ritorno sulla posteriore destra).  
 Rese indicative GDV: radiatore singolo x1,65

# RING RGH

PREZZI DAL 01.03.2026 +5%

RING-H è un calorifero prodotto con tubi radianti quadrati 20 x 20 mm e collettori orizzontali

zontali tondi. Le numerose misure disponibili e l'alta resa termica grazie anche alla versione

con tubi radianti doppi, lo rendono il calorifero ideale per essere installato in ogni ambiente.

## DIMENSIONI mod. RGH e RGDH

Altezze: da 160 a 220 cm, ogni 20 cm  
Larghezze: da 28 a 70 cm, ogni 3,5 cm  
Profondità: 5 / 7 cm  
Sporgenza dal muro: 8 / 8,5 cm

## MODELLI RGH e RGDH con tubi radianti verticali

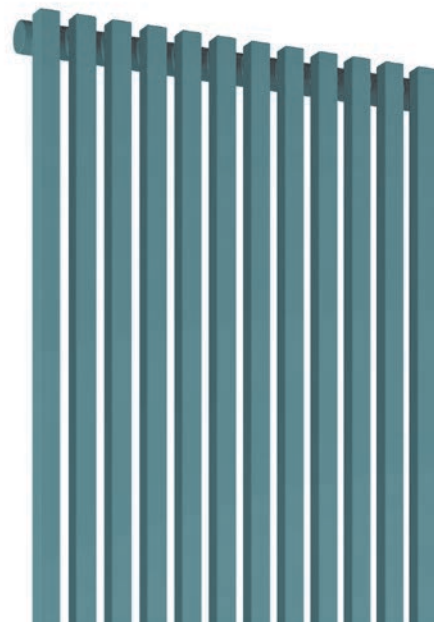
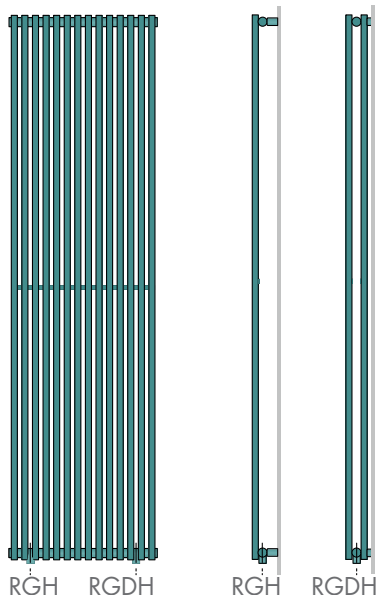
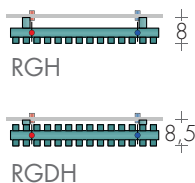

EN 442 Watt  $\Delta t$  50K ( $\Delta t$  40K = Wx0,755) - ( $\Delta t$  30K = Wx0,526)

MODELLO	n. el	8 el	9 el	10 el	11 el	12 el	13 el	14 el	15 el	16 el	17 el	18 el	19 el	20 el
H cm	L cm	28	31,5	35	38,5	42	45,5	49	52,5	56	59,5	63	66,5	70
	▲▼ cm	14	17,5	21	24,5	28	31,5	35	38,5	42	45,5	49	52,5	56
RGH 160	€	421,40 567w	440,70 638W	460,00 708W	479,30 779W	498,60 850W	518,00 921W	537,20 991W	556,50 1062W	575,70 1133W	595,00 1204W	614,40 1275W	633,70 1346W	653,00 1416W
RGDH 160	€	641,00 838w	668,40 943W	695,70 1047W	723,10 1152W	750,40 1257W	777,80 1362W	805,10 1466W	832,50 1571W	859,80 1676W	887,30 1781W	914,60 1885W	942,00 1990W	969,40 2095W
RGH 180	€	447,30 634w	467,60 713W	487,80 792W	508,20 872W	528,50 951W	548,70 1030W	569,00 1109W	589,40 1189W	609,60 1268W	629,90 1347W	650,20 1426W	670,40 1505W	690,70 1584W
RGDH 180	€	682,10 939w	710,70 1056W	739,40 1174W	768,10 1291w	796,70 1409w	825,40 1526w	854,10 1643w	882,70 1761w	911,40 1878w	940,10 1995w	968,70 2113w	997,50 2230W	1026,20 2348w
RGH 200	€	473,20 701w	494,60 789W	515,90 876W	537,20 964w	558,40 1051w	579,70 1139w	600,90 1227w	622,20 1315w	643,40 1402w	664,80 1490w	686,10 1577w	707,30 1665w	728,50 1752w
RGDH 200	€	723,00 1040w	753,10 1170w	783,00 1300w	813,00 1430w	843,00 1560w	873,00 1690w	902,90 1820w	932,90 1950w	962,90 2080w	992,90 2210w	1022,90 2340w	1052,90 2470w	1082,90 2600w
RGH 220	€	499,20 768w	521,40 864w	543,70 960w	566,00 1056w	588,20 1152w	610,50 1248w	632,70 1344w	655,00 1440w	677,30 1536w	699,60 1632w	721,90 1728w	744,10 1824w	766,30 1920w
RGDH 220	€	764,10 1141w	795,40 1284w	826,70 1427w	858,00 1569w	889,20 1712w	920,50 1855w	951,80 1997w	983,10 2140w	1014,40 2283w	1045,70 2425w	1077,00 2568w	1108,40 2711w	1139,70 2853w

## ESECUZIONI DI SERIE

Colore bianco sablé SB9016 mensole bianche  
Tolleranze  $\pm$  3mm - Valvola di sfianto  $\varnothing$  1/8"  
PRESSIONE MASSIMA D'ESERCIZIO 6 BAR

## ESECUZIONI A RICHIESTA

Verniciatura in una tinta della tabella colori  
Brem con fissaggi colorati +15/25%  
Versione elettrica, non disponibile

## ATTACCHI DI SERIE

EG  $\varnothing$  1/2"

Altri attacchi, a richiesta



INTERASSE ATTACCHI

Mod. RGH e RGDH, tubi radianti verticali

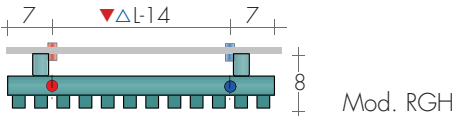
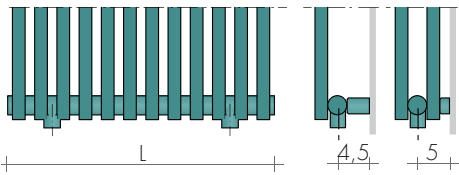

Mod. RGH

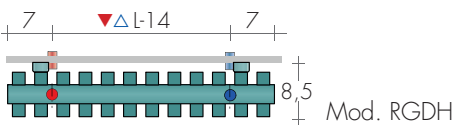

Mod. RGDH

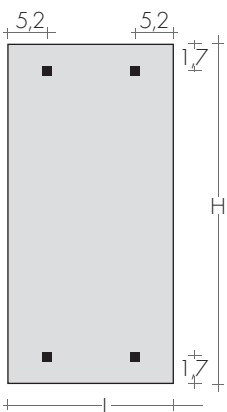

FISSAGGI  
Mensole comprese

Mod. mensole  
RGH G30  
RGDH B15



RING RGH 180-42

VALVOLE CONSIGLIATE

KIT VALVOLE CROMATE comprende:

- n°2 Valvole con codoli
- n°2 Raccordi (per multistrato ø16 e rame ø12 e 14)
- n°2 Rosette tonde cromo ø 48, foro ø16

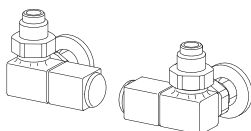

KIT VALVOLE QUADRA comando LATERALE  
pag. 271 Art. KQL 177,10€  
Colore tabella BREM supplemento 49,50€

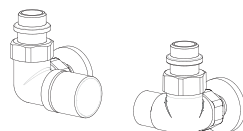

KIT VALVOLE CYL termostattabile con comando LATERALE, pag.273 Art. KCL 150,50€  
Colore tabella BREM supplemento 49,50€

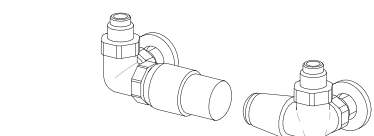
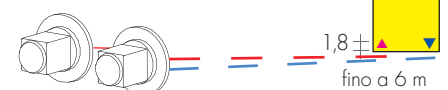

KIT VALVOLE TON comando LATERALE con testa TERMOSTATICA, pag. 269 Art. KTL 188,60€

FINITURE SPECIALI

pag. 267  
Finiture Oro, Bronzo, Nickel spazzolato per 2 valvole  
KIT Raccordi NICKEL spazz. suppl.Art. RN 28,20€

ATTACCHI REMOTI

Art. REM 37,60€  
Interasse attacchi sul retro: ▲▽ EG (solo Mod. RGH)  
Valvole REMOTE pag. 274

RING-V è un calorifero con tubi radianti orizzontali quadrati 20 x20 mm e collettori verticali

cali per l'utilizzo classico sotto la finestra. Le numerose misure e l'alta resa termica grazie

alla versione con tubi radianti doppi, lo rendono il calorifero ideale per ogni ambiente.

## DIMENSIONI mod. RGV e RGDV

Lunghezza: da 50 a 220 cm

Altezze: 49/63/70/91 cm

Profondità: 5 /7 cm

Sporgenza dal muro: 8 /8,5 cm

## MODELLI RGV e RGDV

con tubi radianti orizzontali



RGV



RGDV



RGV RGDV



EN 442 Watt  $\Delta t$  50K ( $\Delta t$  40K =  $W \times 0,755$ ) - ( $\Delta t$  30K =  $W \times 0,526$ )

MODELLO	H cm	n. el	L cm ▲▼,cm	50	60	70	80	90	100	120	140	160	180	200	220
				46,5	56,5	66,5	76,5	86,5	96,5	116,5	136,5	156,5	176,5	196,5	216,5
RGV	49	14	€	409,20	418,40	427,60	436,80	446,00	455,30	473,70	492,00	510,50	528,90	547,40	565,70
				349w	408w	468w	528w	587w	647w	766w	885w	1004w	1123w	1242w	1361w
RGDV	49	14	€	560,30	579,30	598,20	617,20	636,20	655,10	693,10	731,00	768,90	806,80	844,80	882,70
				499w	589w	678w	768w	858w	947w	1126w	1305w	1485w	1664w	1843w	2022w
RGV	63	18	€	478,00	487,30	496,50	505,90	515,20	524,50	543,20	561,80	580,30	598,90	617,60	636,20
				449w	525w	602w	678w	755w	831w	984w	1138w	1291w	1444w	1597w	1750w
RGDV	63	18	€	718,90	732,80	746,60	760,40	774,20	788,00	815,60	843,30	870,90	898,60	926,20	953,80
				642w	757w	872w	987w	1103w	1218w	1448w	1678w	1909w	2139w	2370w	2600w
RGV	70	20	€	511,80	521,10	530,60	539,90	549,40	558,70	577,50	596,30	615,10	633,80	652,60	671,40
				499w	584w	669w	754w	839w	924w	1094w	1264w	1434w	1604w	1774w	1944w
RGDV	70	20	€	773,00	786,20	799,60	812,80	826,00	839,40	865,80	892,40	919,00	945,50	972,00	998,60
				713w	841w	969w	1097w	1225w	1353w	1609w	1865w	2121w	2377w	2633w	2889w
RGV	91	26	€	531,90	546,70	561,50	576,50	591,30	606,10	635,70	665,40	695,00	724,60	754,30	783,90
				648w	759w	869w	980w	1090w	1201w	1422w	1643w	1864w	2085w	2307w	2528w
RGDV	91	26	€	778,20	799,50	820,80	842,20	863,50	884,20	927,60	970,20	1012,90	1055,60	1098,30	1140,90
				927w	1093w	1260w	1426w	1593w	1759w	2092w	2424w	2757w	3090w	3423w	3755w

MISURE A RICHIESTA: Lunghezze ogni 10 cm da 50 a 220 cm (valori per interpolazione) - NUMERO ELEMENTI da 8 a 30

## ESECUZIONI DI SERIE

Colore bianco sablé SB9016 mensole bianche  
Tolleranze  $\pm$  3mm - Valvola di sfianto  $\varnothing$  1/8"  
PRESSIONE MASSIMA D'ESERCIZIO 6 BAR

## ESECUZIONI A RICHIESTA

Verniciatura in una tinta della tabella colori  
Brem con fissaggi colorati +15/25%  
Versione elettrica, non disponibile

## ATTACCHI DI SERIE

EG  $\varnothing$  1/2"

Altri attacchi, a richiesta



INTERASSE ATTACCHI

Mod. RGV e RGDV, tubi radianti orizzontali

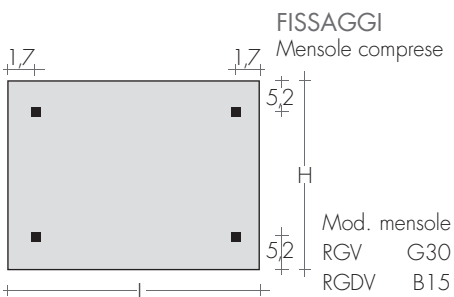
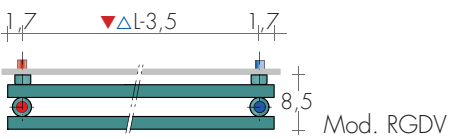
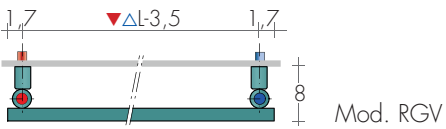
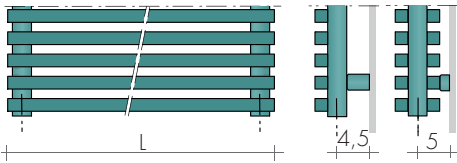

RING RGDV 70-120

VALVOLE CONSIGLIATE

KIT VALVOLE CROMATE comprende:

- n°2 Valvole con codoli
- n°2 Raccordi (per multistrato ø16 e rame ø12 e 14)
- n°2 Rosette tonde cromo ø 48, foro ø16

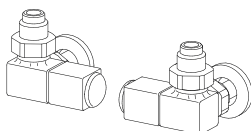

KIT VALVOLE QUADRA comando LATERALE  
 pag. 271 Art. KQL 177,10€  
 Colore tabella BREM supplemento 49,50€

FINITURE SPECIALI

pag. 267  
 Finiture Oro, Bronzo, Nickel spazzolato per 2 valvole  
 KIT Raccordi NICKEL spazz. suppl.Art. RN 28,20€

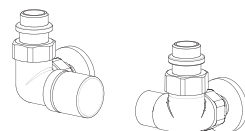

KIT VALVOLE CYL termostattabile con comando LATERALE, pag.273 Art. KCL 150,50€  
 Colore tabella BREM supplemento 49,50€

ATTACCHI REMOTI

Art. REM 37,60€  
 Interasse attacchi sul retro: ▲▽ EG (solo Mod. RGV)  
 Valvole REMOTE pag. 274

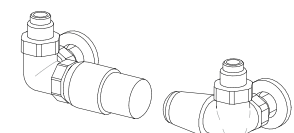
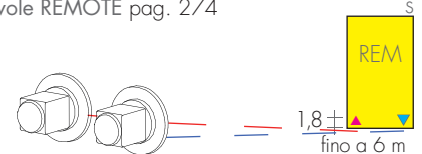

KIT VALVOLE TON comando LATERALE con testa TERMOSTATICA, pag. 269 Art. KTL 188,60€

design Luigi Brembilla

WIND è costruito con elementi da tre a sei colonne, realizzati con tubi tondi a bassissimo

contenuto d'acqua uniti da testate dal design esclusivo. Le batterie sono ottenute

saldando tra di loro gli elementi secondo il numero richiesto, evitando nipples di giunzione.

PASSO ELEMENTI: PE = 3 cm

DIAMETRO TUBI:  $\varnothing = 1,5$  cm

LUNGHEZZA CALORIFERI ( $\pm 3$  mm):  
numero elementi x PE (3 cm)

Rinforzo metallico posto sul retro da 21 el.  
H = da 29 a 200 cm

L = da 30 a 108 cm (ogni 3 cm)

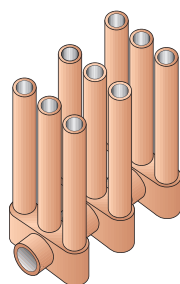

MODELLO W 3 Elemento con 3 tubi radianti

MODELLO W 4 Elemento con 4 tubi radianti

MODELLO W 5 Elemento con 5 tubi radianti

MODELLO W 6 Elemento con 6 tubi radianti

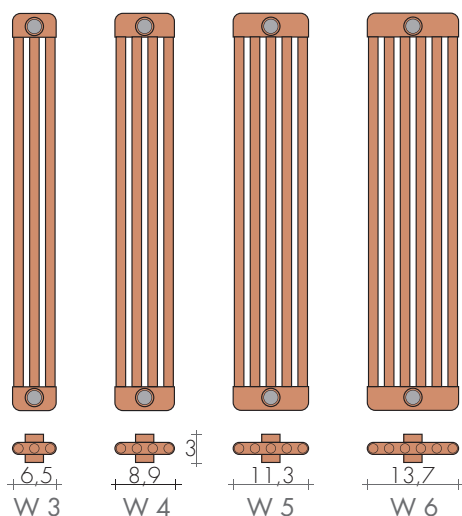

INTERASSE ATTACCHI DI SERIE

AC - BD / AD - BC  $\varnothing 1/2''$

Attacchi laterali  $\blacktriangle \nabla = H - 4,6$  cm

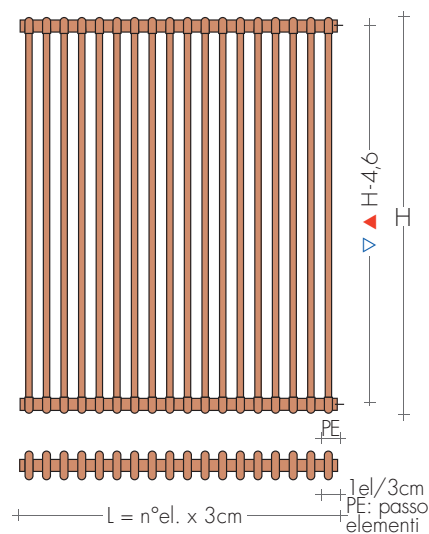

INTERASSE ATTACCHI  $\pm 6$  CM

Utilizzare eccentrici cromati per variare l'interasse degli attacchi fino a 6 cm (Art. EC.. pag.278)

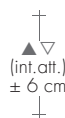

ESECUZIONI DI SERIE

Colore bianco sablé SB9016, con mensole  
Valvola di sfiato  $\varnothing 1/2''$ - Tolleranze  $\pm 3$ mm  
PRESSIONE MASSIMA D'ESERCIZIO 8 BAR

ESECUZIONI A RICHIESTA

Verniciatura tabella colori Brem con mensole  
nello stesso colore +15/25%  
Batterie con numero elementi fuori tabelle

ATTACCHI DI SERIE

AC - BD / AD - BC  $\varnothing 1/2''$   
A richiesta attacchi EG o GE  
Attacchi speciali, pag. 278

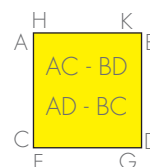

ATTACCHI VERTICALI A RICHIESTA

INTERASSE EG  $\varnothing 1/2''$  (GE) con manicotti e separatore Art. AS 81,40€

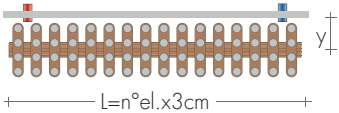
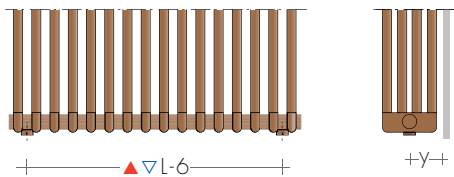

W 3	y = 5 cm	W 5	y = 7 cm
W 4	y = 5,5 cm	W 6	y = 7,5 cm

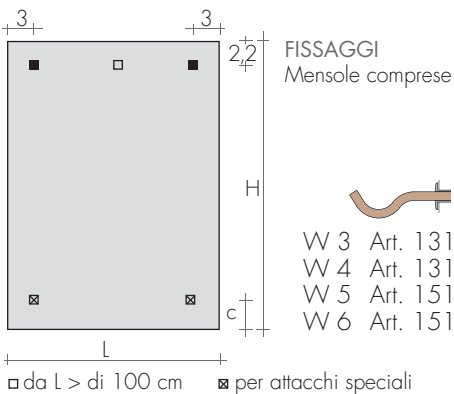

WIND 3200 12 el.

VALVOLE CONSIGLIATE

KIT VALVOLE CROMATE comprende:

- n°2 Valvole con codoli
- n°2 Raccordi (per multistrato  $\varnothing 16$  e rame  $\varnothing 12$  e 14)
- n°2 Rosette tonde cromo  $\varnothing 48$ , foro  $\varnothing 16$

FINITURE SPECIALI

pag. 267  
Finiture Oro, Bronzo, Nickel spazzolato per 2 valvole  
KIT Raccordi NICKEL spazz. suppl. Art. RN 28,20€

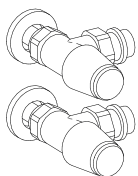

KIT VALVOLE TON A SQUADRA  
pag. 269 Art. KVS 127,00€

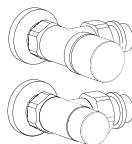

KIT VALVOLE CYL termostattabile A SQUADRA  
pag. 273 Art. KCS 138,80€  
Colore tabella BREM supplemento 49,50€

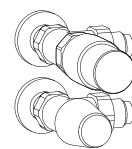

KIT VALVOLE TON A SQUADRA con TESTA TER-  
MOSTATICA, pag. 269 Art. KTS 176,20€

MOD.	H cm	▲▼ cm	p n° cm	el L cm	(3)	10el (30)	11el (33)	12el (36)	13el (39)	14el (42)	15el (45)	16el (48)	17el (51)	18el (54)	19el (57)	20el (60)	EN 442 Watt Δt 50K (Δt 40K = Wx0,755) - (Δt 30K = Wx0,526)	
																	€	
W 3065	66,6	62	6,5	3	€ 27,50	273,40	300,70	328,00	355,20	382,60	410,20	437,50	464,70	492,00	519,30	546,70		
W 3075	76,6	72	6,5	3	€ 29,00	288,80	317,70	346,60	375,60	404,30	433,20	462,00	490,90	519,70	548,80	577,40		
W 3085	86,6	82	6,5	3	€ 30,40	303,90	334,50	365,00	395,60	425,80	456,30	486,80	517,20	547,50	577,80	608,50		
W 3180	178,3	173,7	6,5	3	€ 58,90	586,10	644,50	703,10	761,80	820,30	879,00	937,30	996,20	1054,7	1113,3	1171,8		
W 3200	198,3	193,7	6,5	3	€ 65,50	654,70	720,00	785,50	850,80	916,50	981,90	1047,5	1112,6	1178,2	1243,5	1309,1		
W 4065	66,6	62	8,9	3	€ 31,30	311,90	343,00	374,20	405,50	436,80	467,80	499,10	530,40	561,70	592,60	623,90		
W 4075	76,6	72	8,9	3	€ 33,00	327,50	360,20	392,80	425,60	458,20	490,90	523,80	556,40	589,10	621,70	654,60		
W 4085	86,6	82	8,9	3	€ 34,20	342,60	377,00	411,20	445,60	479,90	514,20	548,30	582,20	616,60	650,90	685,30		
W 4180	178,3	173,7	8,9	3	€ 63,80	637,90	701,80	765,60	829,20	892,90	956,90	1020,6	1084,2	1148,1	1211,8	1275,6		
W 4200	198,3	193,7	8,9	3	€ 71,00	711,70	782,70	853,90	925,10	996,20	1067,3	1138,4	1209,6	1280,8	1352,1	1423,0		
W 5027	29,1	24,5	11,3	3	€ 30,20	302,50	332,40	362,50	393,10	423,00	453,40	483,80	513,90	544,20	574,20	604,40		
W 5053	54,6	50	11,3	3	€ 34,70	346,60	381,30	415,70	450,60	485,00	519,70	554,80	589,10	623,90	658,40	693,20		
W 5065	66,6	62	11,3	3	€ 35,20	352,50	387,70	422,70	458,00	493,20	528,40	563,60	599,20	634,20	669,30	704,70		
W 5075	76,6	72	11,3	3	€ 37,10	371,80	408,60	446,10	483,10	520,30	557,20	594,30	631,60	669,00	706,00	743,20		
W 5085	86,6	82	11,3	3	€ 38,30	383,20	421,50	459,70	498,00	536,20	574,50	613,10	651,00	689,70	727,80	766,20		
W 6027	29,1	24,5	13,7	3	€ 33,20	329,20	362,00	395,30	427,70	461,20	494,00	526,70	559,70	592,60	625,30	658,40		
W 6053	54,6	50	13,7	3	€ 38,80	386,90	425,70	464,50	503,00	541,70	580,40	619,00	657,90	696,40	735,20	774,10		
W 6065	66,6	62	13,7	3	€ 39,90	398,60	438,20	478,10	518,40	558,10	597,90	637,80	677,70	717,40	757,30	797,10		
W 6075	76,6	72	13,7	3	€ 41,30	413,90	455,30	496,80	538,20	579,70	620,90	662,20	703,60	745,10	786,70	827,90		
W 6085	86,6	82	13,7	3	€ 43,20	429,60	472,20	515,30	558,20	600,90	644,00	686,80	730,00	772,80	815,80	858,60		

TubiDESIGN

### ORDINE

Indicare: il modello, il numero delle colonne, l'altezza in cm e il numero degli elementi; l'attacco ed il colore

Mod. Wind      numero colonne      altezza cm      numero elementi

W 3075 - 19 el

Esempio: W 3075 - 19, AC 1/2", BR0007

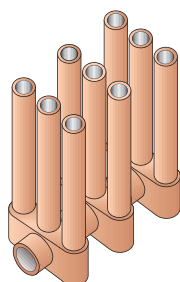

### ESECUZIONI A RICHIESTA

Batterie da 3 a 9 el. supplemento 25,80€  
Batterie ≥ 40 el. suppl. a radiatore 56,40€

EN 442 Watt Δt 50K (Δt 40K = Wx0,755) - (Δt 30K = Wx0,526)

21el (63)	22el (66)	23el (69)	24el (72)	25el (75)	26el (78)	27el (81)	28el (84)	29el (87)	30el (90)	31el (93)	32el (96)	33el (99)	34el (102)	35el (105)	36el (108)	MOD. H cm
574,10 875w	601,50 917w	628,60 959w	656,10 1001w	683,40 1042w	710,80 1084w	738,10 1126w	765,30 1167w	792,70 1209w	820,10 1251w	847,40 1292w	874,60 1334w	902,10 1376w	929,30 1417w	956,90 1459w	984,40 1501w	€ W 3065
606,40 1017w	635,10 1066w	664,50 1114w	693,20 1163w	722,10 1211w	750,70 1260w	779,80 1308w	808,60 1357w	837,70 1405w	866,30 1453w	895,30 1502w	924,10 1550w	953,00 1599w	982,00 1647w	1010,9 1696w	1039,7 1744w	€ W 3075
638,60 1136w	669,20 1190w	699,70 1244w	730,10 1298w	760,40 1352w	790,60 1406w	821,20 1460w	851,80 1514w	882,10 1568w	912,60 1622w	942,90 1677w	973,50 1731w	1003,7 1785w	1034,2 1839w	1064,8 1893w	1095,0 1947w	€ W 3085
1230,5 2248w	1289,1 2355w	1347,7 2462w	1406,3 2569w	1465,0 2676w	1523,3 2783w	1581,9 2890w	1640,7 2997w	1699,2 3104w	1757,9 3211w	1816,3 3318w	1874,9 3425w	1933,8 3532w	1992,2 3639w	2050,9 3746w	2109,2 3853w	€ W 3180
1374,7 2484w	1440,0 2603w	1505,5 2721w	1570,8 2839w	1636,4 2958w	1701,9 3076w	1767,3 3194w	1832,8 3312w	1898,3 3431w	1963,6 3549w	2029,2 3667w	2094,5 3786w	2160,0 3904w	2225,5 4022w	2290,9 4141w	2356,5 4259w	€ W 3200
654,80 1088w	686,10 1140w	717,40 1192w	748,30 1244w	779,80 1296w	811,20 1348w	842,10 1399w	873,30 1451w	904,60 1503w	935,60 1555w	966,60 1607w	998,00 1659w	1029,1 1710w	1060,3 1762w	1091,7 1814w	1122,6 1866w	€ W 4065
687,50 1254w	720,00 1314w	752,90 1373w	785,10 1433w	818,50 1493w	850,90 1553w	883,90 1612w	916,60 1672w	949,10 1732w	982,00 1791w	1014,6 1851w	1047,2 1911w	1080,2 1971w	1112,6 2030w	1145,6 2090w	1178,2 2150w	€ W 4075
719,40 1420w	753,80 1487w	788,00 1555w	822,50 1622w	856,60 1690w	890,80 1758w	925,10 1825w	959,20 1893w	993,60 1960w	1028,0 2028w	1062,4 2096w	1096,8 2163w	1131,0 2231w	1165,4 2298w	1199,6 2366w	1233,8 2434w	€ W 4085
1339,5 2745w	1403,1 2875w	1466,9 3006w	1530,8 3137w	1594,6 3267w	1658,4 3398w	1722,1 3529w	1785,7 3660w	1849,7 3790w	1913,4 3921w	1977,4 4052w	2040,9 4182w	2104,8 4313w	2168,6 4444w	2232,4 4574w	2296,0 4705w	€ W 4180
1494,2 3052w	1565,2 3198w	1636,4 3343w	1707,6 3488w	1778,9 3634w	1849,9 3779w	1921,2 3924w	1992,2 4070w	2063,4 4215w	2134,5 4360w	2205,8 4506w	2276,7 4651w	2347,9 4796w	2419,2 4942w	2490,2 5087w	2561,4 5232w	€ W 4200
634,80 568w	664,90 595w	695,30 622w	725,40 649w	755,60 676w	785,70 703w	816,20 730w	846,20 757w	876,80 784w	906,90 811w	937,00 838w	967,40 865w	997,30 892w	1027,6 919w	1058,0 946w	1088,0 973w	€ W 5027
727,70 1112w	762,60 1165w	797,10 1218w	831,60 1271w	866,30 1324w	901,00 1377w	935,60 1430w	970,40 1483w	1005,0 1536w	1039,7 1589w	1074,4 1642w	1108,9 1695w	1143,7 1748w	1178,2 1800w	1212,9 1853w	1247,6 1906w	€ W 5053
739,80 1325w	775,00 1388w	810,10 1451w	845,70 1514w	880,80 1577w	916,20 1640w	951,30 1704w	986,60 1767w	1021,8 1830w	1057,0 1893w	1092,3 1956w	1127,5 2019w	1162,5 2082w	1197,8 2145w	1233,1 2208w	1268,2 2271w	€ W 5065
780,30 1538w	817,30 1611w	854,70 1684w	891,80 1758w	928,70 1831w	966,10 1904w	1003,1 1977w	1040,4 2051w	1077,4 2124w	1114,9 2197w	1151,8 2270w	1189,0 2344w	1226,2 2417w	1263,3 2490w	1300,3 2563w	1337,5 2636w	€ W 5075
804,50 1727w	843,00 1809w	881,10 1892w	919,40 1974w	958,00 2056w	996,00 2138w	1034,5 2221w	1072,7 2303w	1111,2 2385w	1149,4 2467w	1187,5 2550w	1225,7 2632w	1264,3 2714w	1302,6 2796w	1340,6 2879w	1379,2 2961w	€ W 5085
691,30 710w	724,20 744w	757,30 777w	790,20 811w	823,20 845w	855,90 879w	889,00 913w	921,70 946w	954,70 980w	987,70 1014w	1020,5 1048w	1053,4 1082w	1086,2 1115w	1119,4 1149w	1152,2 1183w	1185,1 1217w	€ W 6027
812,50 1349w	851,60 1413w	889,80 1477w	928,60 1541w	967,50 1606w	1006,3 1670w	1044,5 1734w	1083,5 1798w	1122,1 1862w	1161,0 1927w	1199,7 1991w	1238,4 2055w	1277,0 2119w	1315,6 2184w	1354,5 2248w	1393,1 2312w	€ W 6053
836,90 1609w	876,90 1686w	916,70 1762w	956,20 1839w	996,40 1915w	1036,2 1992w	1075,7 2069w	1115,7 2145w	1155,8 2222w	1195,7 2298w	1235,1 2375w	1275,1 2452w	1315,3 2528w	1354,9 2605w	1394,8 2682w	1434,6 2758w	€ W 6065
869,30 1846w	910,80 1933w	951,90 2021w	993,30 2109w	1034,9 2197w	1076,4 2285w	1117,6 2373w	1159,0 2461w	1200,4 2549w	1241,8 2636w	1283,1 2724w	1324,5 2812w	1365,7 2900w	1407,7 2988w	1448,8 3076w	1490,3 3164w	€ W 6075
901,60 2035w	944,40 2132w	987,20 2229w	1030,5 2326w	1073,2 2422w	1116,2 2519w	1159,1 2616w	1202,0 2713w	1245,1 2810w	1288,0 2907w	1330,9 3004w	1373,9 3101w	1416,8 3198w	1459,5 3294w	1502,6 3391w	1545,6 3488w	€ W 6085

Δt diversi da 50 K: consultare Dati tecnici Brem

ATTACCHI Ø 1/2" A RICHIESTA

- EG - GE con manicotti e separatore  
(interasse attacchi: L- 6cm) Art. AS 81,40€  
- CD - DC con separatore  
(interasse attacchi: L+8,4cm),  
Supplemento Art. AS 81,40€

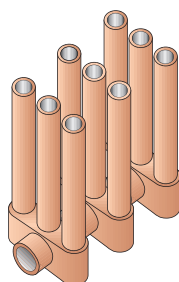

Rinforzo metallico posto sul retro da 21 el.

ATTACCHI DI SERIE  
Ø 1/2"  
AC - BD / AD - BC

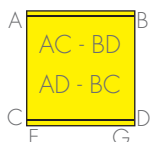

Cannuccia è un simpatico termoarredo ispirato al famoso tubicino di plastica usato

per assaporare le bibite. Cannuccia è porta salviette o appendiabito ed è disponibile in

tre dimensioni, con diverse angolazioni a parete per comporre varie configurazioni.

*design Bettazzi+Percoco Architects*

## DIMENSIONI

Larghezze: da 15 a 51 cm  
Altezze: 160/175/190 cm  
Profondità: 17/14/16 cm

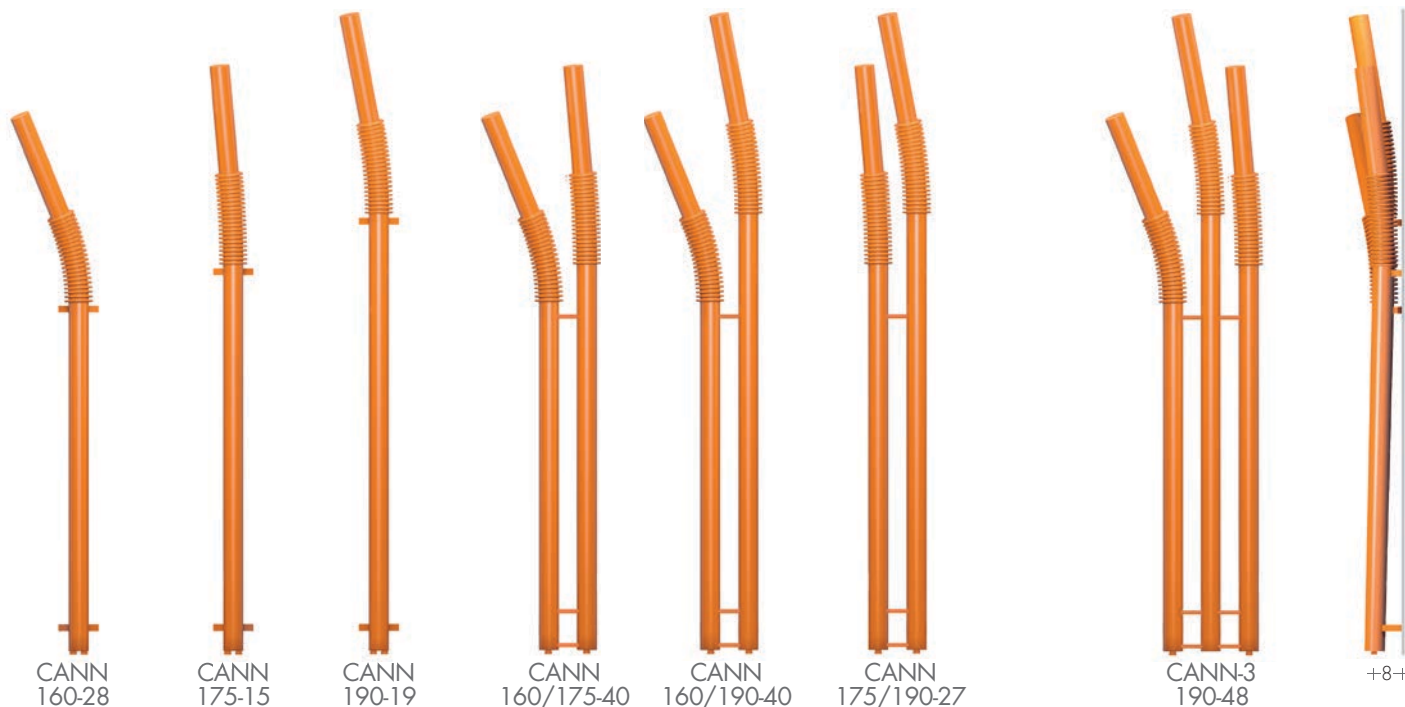

MODELLO CANNUCCIA	H-L cm	Biancodi serie sablé SB9016 €	EN 442			▲▼ int.att. cm	Altezza		Peso M Kg	Volume V dm <sup>3</sup>	VERSIONI MISTE con Resistenza e* Watt €	
			Δt 50K watt	Δt 40K watt	Δt 30K watt		H cm	L cm				
CANN	160-28	538,00	141	106	74	3,6	160	27,2	4,2	4,4	-	-
CANN	175-15	557,60	155	117	82	3,6	175	14,7	4,5	4,7	-	-
CANN	190-19	577,00	167	126	88	3,6	190	19,1	4,8	5,1	-	-
CANN	160/175-40	869,30	301	227	158	12	175	35,7	8,1	9,1	300	94,60
CANN	160/190-40	888,60	313	236	165	12	190	35,7	8,4	9,5	300	94,60
CANN	175/190-27	908,00	327	247	172	12	190	23,2	8,7	9,9	400	95,70
CANN-3	190-48	1155,10	473	357	249	24	190	47,7	12,2	14,3	500	97,80
CAN-P	160/190-47	1136,10	568	429	244	19	190	42,7	16,3	11,2	650	99,80
CAN-3P	190-51	1402,60	807	609	342	27	190	50,7	22,7	16,5	800	104,20

\*Aggiungere: Valvola mista o TR p.207  
Termostati p.208-209

## PORTA-SALVIETTE MCA: COLORI DI SERIE

- bianco sablé SB 9016 - grigio sablé SB 7039  
- nero sablé SB 9005 - nel colore del radiatore

Art. MCA 30 75,10€ 30/15 cm (L/P)  
Art. MCA 36 81,50€ 36/18 cm (L/P)

In un colore della tabella Brem diverso dallo  
scaldasalviette Supplemento 49,00€



## ESECUZIONI DI SERIE

Colore bianco sablé SB 9016, mensole bianche  
Valvola di sfiato ø 1/8" - Tolleranze ± 3mm  
PRESSIONE MASSIMA D'ESERCIZIO 8 BAR

## ESECUZIONI A RICHIESTA

Verniciatura tabella colori Brem con mensole  
colorate +15/25%  
Versione elettrica e.Cannuccia, pag. 213

## ATTACCHI DI SERIE

EG ø 1/2"  
A richiesta attacchi ø 3/8"



INTERASSE ATTACCHI MOD. CANN ...

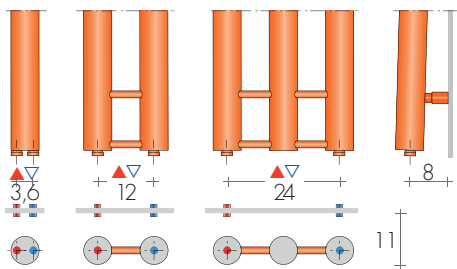

CAN-P  
160/190-47

CAN-3P  
190-51

MODELLO CAN-P.. con piastra radiante

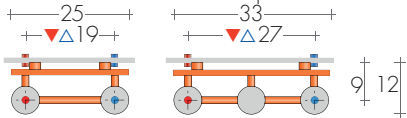

VALVOLE CONSIGLIATE

KIT VALVOLE CROMATE comprende:

- n°2 Valvole con codoli
- n°2 Raccordi (per multistrato ø16 e rame ø12 e 14)
- n°2 Rosette tonde cromo ø 48, foro ø16

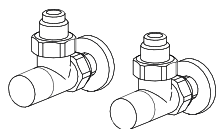

KIT VALVOLE MINI A SQUADRA  
cromo Art. KMS

pag.270  
114,80€

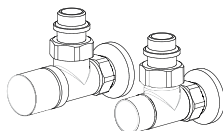

KIT VALVOLE CYL termostattabile A SQUADRA  
pag. 273 Art. KCS 138,80€  
Colore tabella BREM supplemento 49,50€

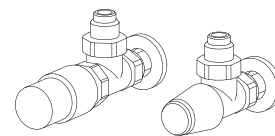

KIT VALVOLE TON A SQUADRA TESTA TERMO-  
STATICA, pag. 269 Art. KTS 176,20€

FINITURE SPECIALI

pag. 267  
Finiture Oro, Bronzo, Nickel spazzolato per 2 valvole  
KIT Raccordi NICKEL spazz. suppl.Art. RN 28,20€

ATTACCHI REMOTI

Art. REM 37,60€  
Interasse attacchi sul retro: ▲▼ EG  
Valvole REMOTE pag. 274

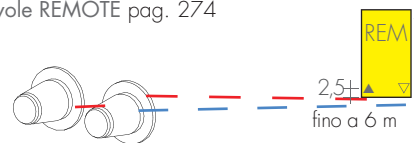

CANN 160/190-40

design Davide Diliberto

CHEM è un calorifero ad elementi realizzati in tubo tondo di 9 cm di diametro con la parte

terminale che curva verso la parete. È prodotto in varie altezze, completo di un maniglione

reversibile portasalviette sul retro e di un appendino doppio per gli accappatoi.

## DIMENSIONI

Larghezze: 40 / 54 / 68 cm

Altezze: 196 / 216 / 236 cm

Profondità: 18 cm

Sporgenza dal muro: 18 cm

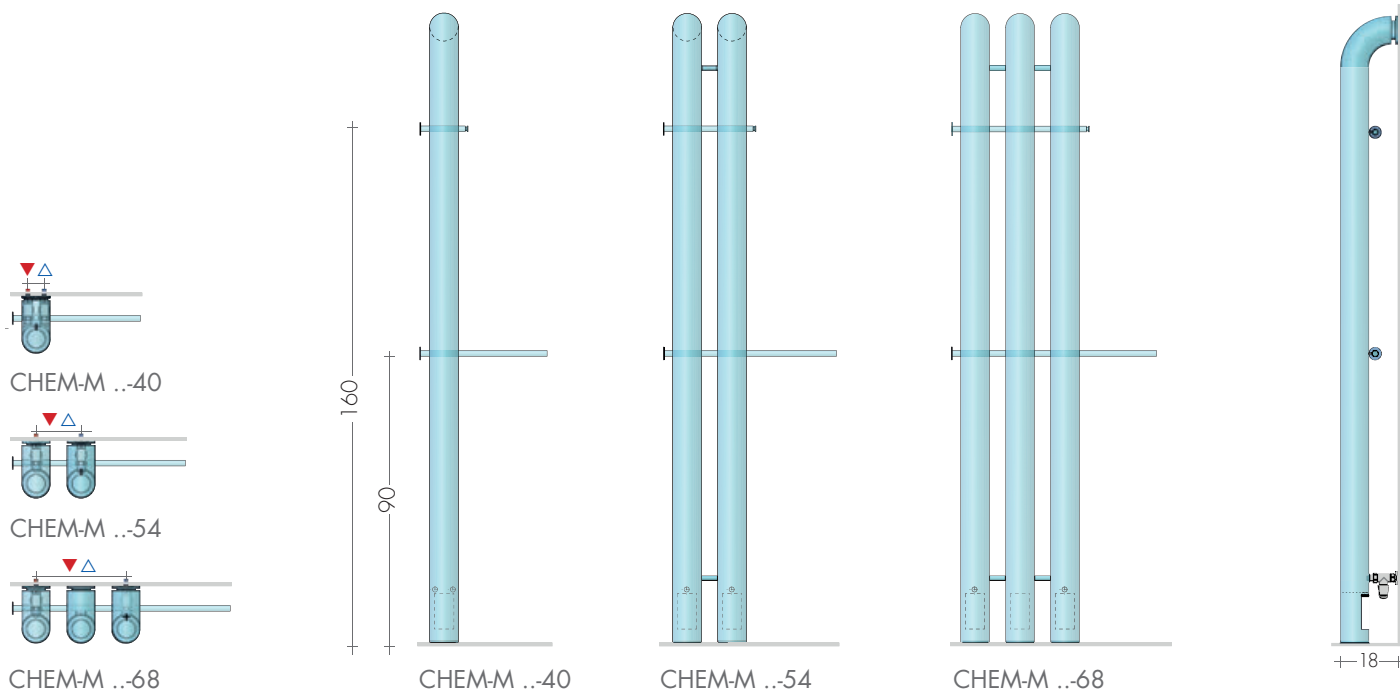

MODELLO	H/L cm	Bianco di serie sablé SB 9016 €	EN 442			▲▽ int.att. cm	Altezza H cm	Larghezza L cm	Peso M Kg	Volume V dm <sup>3</sup>	VERSIONI MISTE con Resistenza* e manicotto Watt €	
			Δt 50K watt	Δt 40K watt	Δt 30K watt							
CHEM-M	196-40	672,00	326	250	177	5	196	40	10,6	5,1	300	116,10
CHEM-M	196-54	882,00	655	502	355	14	196	54	21,0	10,2	650	121,30
CHEM-M	196-68	1097,30	984	754	533	28	196	68	31,5	15,3	900	129,00
CHEM-M	216-40	703,50	367	281	199	5	216	40	11,7	5,7	400	117,20
CHEM-M	216-54	929,30	737	565	399	14	216	54	23,2	11,4	800	125,70
CHEM-M	216-68	1160,30	1107	848	600	28	216	68	34,8	17,1	1200	136,70
CHEM-M	236-40	735,00	408	313	221	5	236	40	12,8	6,4	400	117,20
CHEM-M	236-54	976,50	819	627	444	14	236	54	25,4	12,8	900	129,00
CHEM-M	236-68	1223,30	1230	942	667	28	236	68	38,1	19,2	1200	136,70

A richiesta elementi con altezze 206 e 226. Prezzi e rese per interpolazione.

\*Solo resistenza con cavo  
Termostati da parete p.208

Portasalviette ed appendino possono essere montati con sporgenza a destra o sinistra.

PORTA-SALVIETTE E APPENDINO: COLORI DI SERIE  
- bianco sablé SB 9016 - grigio sablé SB 7039  
- nero sablé SB 9005 - nel colore del radiatore

In un colore della tabella Brem diverso dallo  
scaldasalviette Supplemento 49,00€

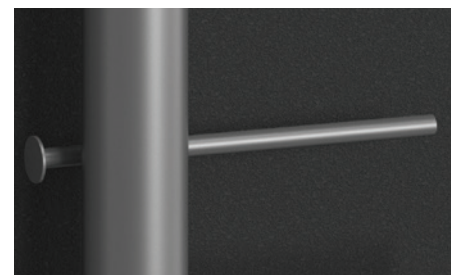
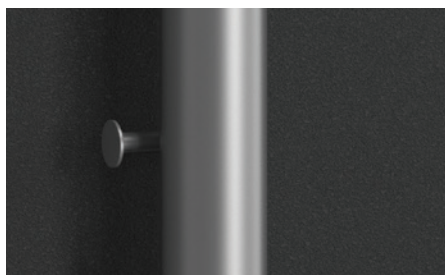

## ESECUZIONI DI SERIE

Colore bianco sablé SB9016 mensole bianche  
Tolleranze ± 3mm - Valvola di sfianto ø 1/8"  
PRESSIONE MASSIMA D'ESERCIZIO 8 BAR

## ESECUZIONI A RICHIESTA

Verniciatura in una tinta della tabella colori  
Brem (con fissaggi colorati) +15/25%  
Versione elettrica, e.Chem-M pag. 214

ATTACCHI DI SERIE EG ø 1/2",  
sul retro del tubo con valvole diritte.  
A richiesta: Allacciamenti laterali  
con valvole a squadra.



INTERASSE ATTACCHI

CHEM-M ..-40

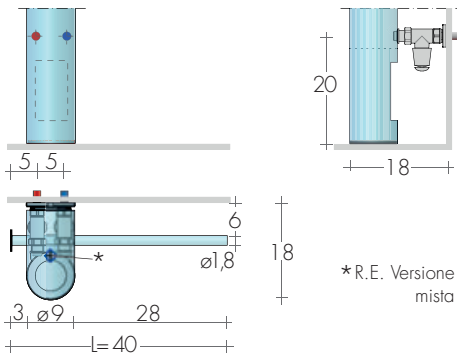

CHEM-M ..-54 / ..-68

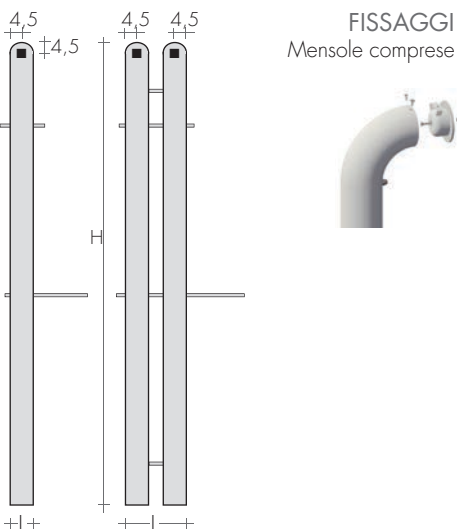
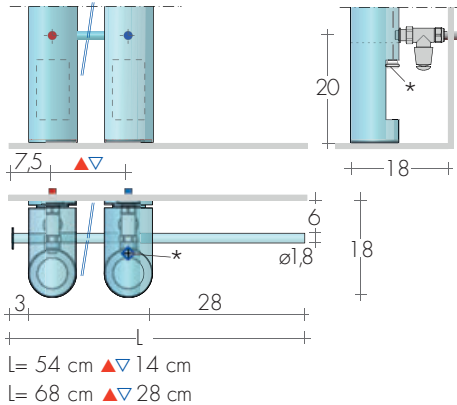

VALVOLE CONSIGLIATE

KIT VALVOLE CROMATE comprende:

- n°2 Valvole con codoli
- n°2 Raccordi (per multistrato ø16 e rame ø12 e 14)
- n°2 Rosette tonde cromo ø 48, foro ø16

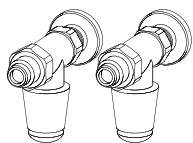

KIT VALVOLE TON DIRITTE pag. 269 Art. KVD 138,20€

KIT VALVOLE MINI DIRITTE cromo, pag.270 Art. KMD 126,70€

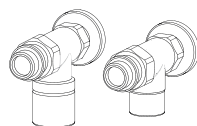

KIT VALVOLE CYL termostattabile DIRITTE pag. 273 Art. KCD 147,00€  
Colore tabella BREM supplemento 49,50€

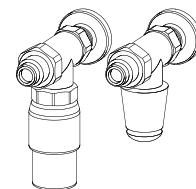

KIT VALVOLE TON DIRITTE con TESTA TERMO-STATICA, pag. 269 Art. KTD 187,50€



CHEM-M 196-40

FINITURE SPECIALI

pag. 267  
Finiture Oro, Bronzo, Nickel spazzolato per 2 valvole  
KIT Raccordi NICKEL spazz. suppl.Art. RN 28,20€

design Davide Diliberto

CHEM, il tubo diametro 9 cm che alla sua estremità curva verso la parete, è disponibile

anche in versione scaldasalviette. È prodotto in vari modelli grazie all'aggiunta di elementi

tubolari quadrati, da uno a tre, applicati ad uno o due elementi verticali.



## DIMENSIONI

Larghezza: 50,5 cm  
Altezze: 196 / 216 cm  
Profondità: 18 cm  
Sporgenza dal muro: 18 cm

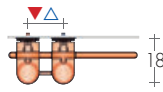
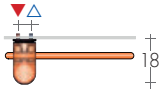

Mod. CHEM-S ..DL.. con 1 tubo sul retro

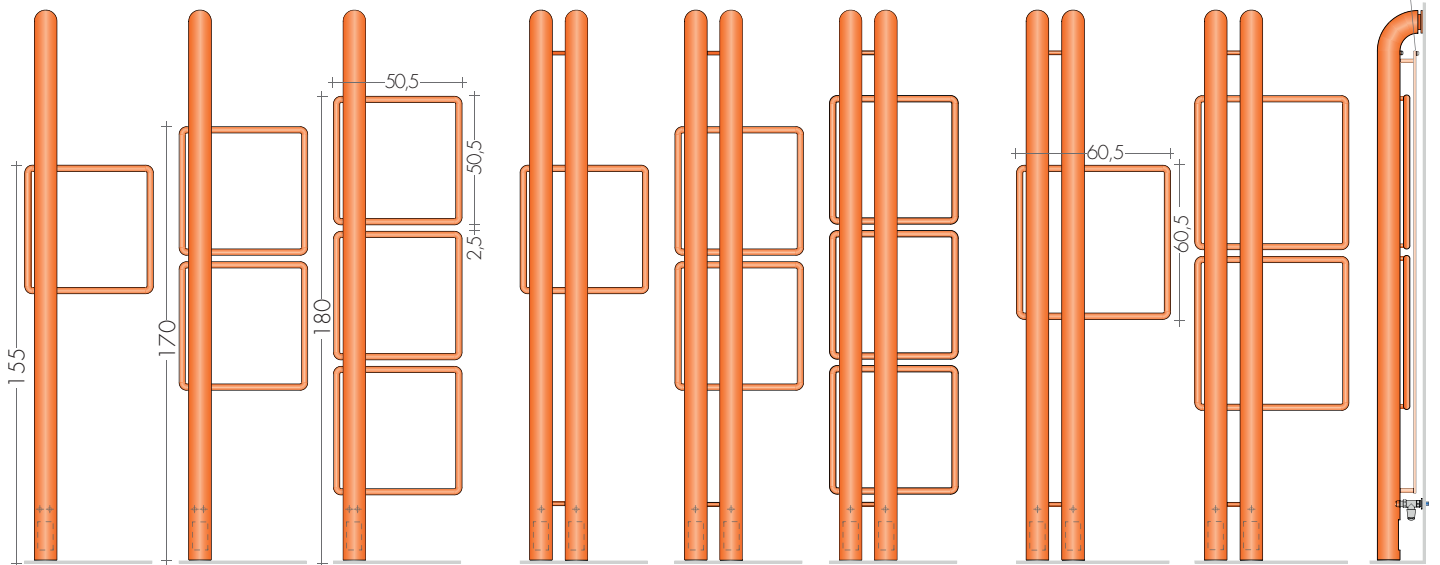
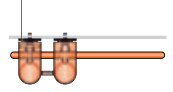

CHEM-S 196-50/1 216-50/1	CHEM-S 196-50/2 216-50/2	CHEM-S 196-50/3 216-50/3	CHEM-S 196D-50/1 216D-50/1	CHEM-S 196D-50/2 216D-50/2	CHEM-S 196D-50/3 216D-50/3	CHEM-S 196D-60/1 216D-60/1	CHEM-S 196D-60/2 216D-60/2 216DL-60/2
--------------------------------	--------------------------------	--------------------------------	----------------------------------	----------------------------------	----------------------------------	----------------------------------	--

MODELLO	H-L cm	Bianco di serie sablé SB 9016 €	EN 442			▲ ▽ int.att. cm	Altezza H cm	Larghezza L cm	Peso M Kg	Volume V dm³	VERSIONI MISTE con Resistenza* e manicotto	
			Δt 50K watt	Δt 40K watt	Δt 30K watt						Resistenza* Watt	manicotto €
CHEM-S	196-50/1	682,50	424	325	230	5	196	50,5	12,5	5,8	400	117,20
CHEM-S	196-50/2	766,50	522	400	283	5	196	50,5	14,7	6,5	500	119,30
CHEM-S	196-50/3	850,50	620	475	336	5	196	50,5	16,9	7,2	650	121,30
CHEM-S	196D-50/1	892,50	753	577	408	14	196	50,5	22,8	10,9	800	125,70
CHEM-S	196D-50/2	976,50	851	652	461	14	196	50,5	25,0	11,6	900	129,00
CHEM-S	196D-50/3	1060,50	949	727	514	14	196	50,5	27,2	12,3	900	129,00
CHEM-S	196D-60/1	914,60	773	592	419	14	196	60,5	23,3	11,0	800	125,70
CHEM-S	196D-60/2	1012,80	891	683	483	14	196	60,5	26,0	11,8	900	129,00
CHEM-S	216-50/1	714,00	465	356	252	5	216	50,5	13,6	6,4	500	119,30
CHEM-S	216-50/2	798,00	563	431	305	5	216	50,5	15,8	7,1	500	119,30
CHEM-S	216-50/3	882,00	661	506	358	5	216	50,5	18,0	7,8	650	121,30
CHEM-S	216D-50/1	924,00	835	640	453	14	216	50,5	25,0	12,1	800	125,70
CHEM-S	216D-50/2	1008,00	933	715	506	14	216	50,5	27,2	12,8	900	129,00
CHEM-S	216D-50/3	1092,00	1031	790	559	14	216	50,5	29,4	13,5	900	129,00
CHEM-S	216D-60/1	946,10	855	655	463	14	216	60,5	25,5	12,2	800	125,70
CHEM-S	216D-60/2	1044,30	973	745	527	14	216	60,5	28,2	13,0	900	129,00
CHEM-S	216DL-60/2	1188,80	1161	889	629	14	216	60,5	31,4	14,0	1200	136,70

Elementi quadrati sporgenti a sinistra, senza supplemento. A richiesta, altezze su misura.

\* Solo resistenza con cavo Termostati da parete p.208

## ESECUZIONI DI SERIE

Colore bianco sablé SB9016 mensole bianche  
Tolleranze ± 3mm - Valvola di sfianto ø 1/8"  
PRESSIONE MASSIMA D'ESERCIZIO 8 BAR

## ESECUZIONI A RICHIESTA

Verniciatura in una tinta della tabella colori  
Brem (con fissaggi colorati) +15/25%  
Versione elettrica e.Chem-S, pag. 215

## ATTACCHI DI SERIE

EG ø 1/2", sul retro del tubo  
Allacciamento solo con valvole diritte



INTERASSE ATTACCHI  
CHEM-S ..

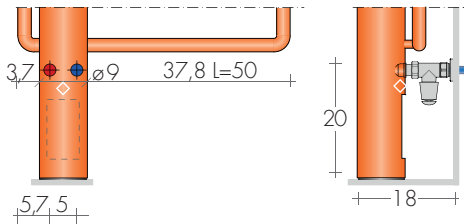

◇ R.E. Versione mista



CHEM-S..D

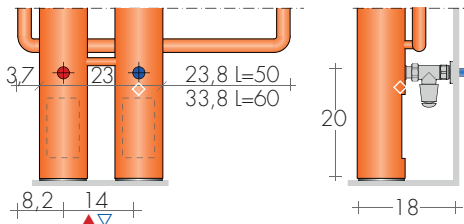

◇ R.E. Versione mista

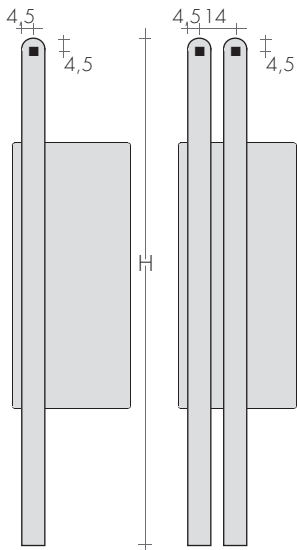
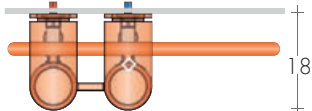

FISSAGGI  
Mensole  
comprese



CHEM-S 216-50/1

VALVOLE CONSIGLIATE

KIT VALVOLE CROMATE comprende:

- n°2 Valvole con codoli
- n°2 Raccordi (per multistrato ø16 e rame ø12 e 14)
- n°2 Rosette tonde cromo ø 48, foro ø16

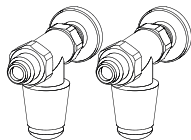

KIT VALVOLE TON DIRITTE

pag. 269 Art. KVD 138,20€

KIT VALVOLE MINI DIRITTE cromo pag.270 Art. KMD 126,70€

FINITURE SPECIALI

pag. 267

Finiture Oro, Bronzo, Nickel spazzolato per 2 valvole

KIT Raccordi NICKEL spazz. suppl.Art. RN 28,20€

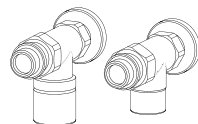

KIT VALVOLE DIRITTE CYL TERMOSTATIZZABILE

pag. 273 Art. KCD 147,00€

Colore tabella BREM supplemento 49,50€

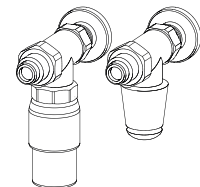

KIT VALVOLE TON DIRITTE con TESTA TERMO-  
STATICA, pag. 269 Art. KTD 187,50€

design Luigi Brembilla

FRAC è lo scaldasalviette di BREM caratterizzato da un'impeccabile purezza di linee.

La leggerezza data dalle dimensioni particolarmente ridotte dei tubi radianti ed il peculiare

design del collettore che fa da cornice, assicurano un perfetto equilibrio compositivo.

## DIMENSIONI

Larghezza: 124/39/49/54/59 cm

Altezze: 44/59/69/99/129/159/189 cm

Profondità: 1,8 cm

Sporgenza dal muro: 8,8 cm

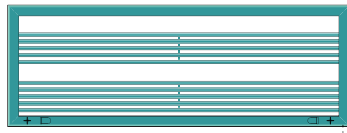

FRAC 44-124

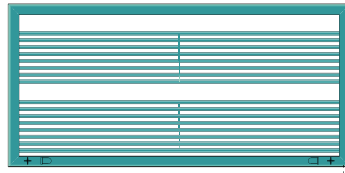

FRAC 59-124



FRAC 69-124

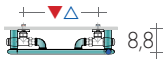

FRAC 99-..

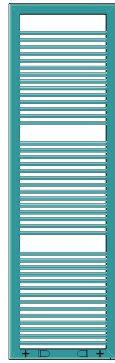

FRAC 129-..

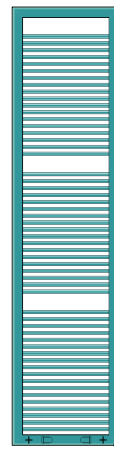

FRAC 159-..

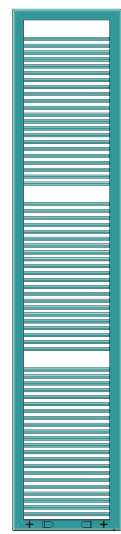

FRAC 189-..



MODELLO	HL cm	Bianco di serie sablé SB 9016 €	EN 442			▲ ▼ int.att. cm	Altezza H cm	Larghezza L cm	Peso M Kg	Volume V dm <sup>3</sup>	VERSIONI MISTE con Resistenza e manicotto	
			Δt 50K watt	Δt 40K watt	Δt 30K watt						Watt	€
FRAC 44-124	44	556,20	477	361	252	112	44	124	6,9	2,5	500	119,30
FRAC 59-124	59	665,20	661	500	349	112	59	124	9,2	3,2	650	121,30
FRAC 69-124	69	766,50	784	593	414	112	69	124	10,7	3,6	800	125,70
FRAC 99-39	99	551,50	387	293	204	27	99	39	5,6	2,0	400	117,20
FRAC 99-49	99	570,90	471	357	249	37	99	49	6,7	2,3	500	119,30
FRAC 129-39	129	640,90	514	389	271	27	129	39	7,3	2,6	500	119,30
FRAC 129-49	129	660,60	626	474	331	37	129	49	8,7	3	650	121,30
FRAC 129-54	129	669,80	682	516	360	42	129	54	9,4	3,2	650	121,30
FRAC 159-39	159	757,70	641	485	338	27	159	39	9,1	3,2	650	121,30
FRAC 159-49	159	777,00	781	591	412	37	159	49	10,8	3,7	800	125,70
FRAC 159-54	159	806,20	846	640	447	42	159	54	11,6	3,9	900	129,00
FRAC 189-39	189	836,60	768	36	406	27	189	39	10,8	3,8	800	125,70
FRAC 189-59	189	885,20	1104	836	583	47	189	59	14,8	5,0	1200	136,70

Termostati p.208-209

## ESECUZIONI DI SERIE

Colore bianco sablé SB9016, mensola B70  
Tolleranze ± 3mm - Valvola di sfianto ø 1/8"  
PRESSIONE MASSIMA D'ESERCIZIO 8 BAR

## ESECUZIONI A RICHIESTA

Verniciatura in una tinta della tabella colori  
Brem con fissaggi B70 colorati +15/25%  
Versione elettrica, e.FRAC pag. 228

## ATTACCHI DI SERIE

REG ø 1/2"  
per valvole reverse  
A richiesta attacchi ø 3/8"



**INTERASSE ATTACCHI**

Di serie attacchi sul retro per valvole reverse

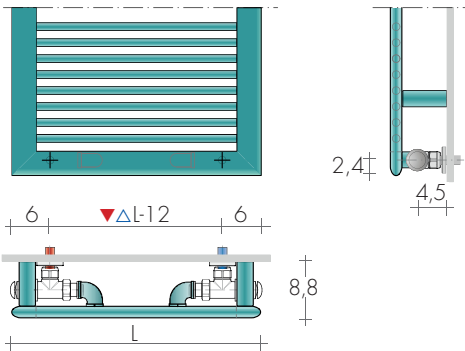

**VERSIONE MISTA**

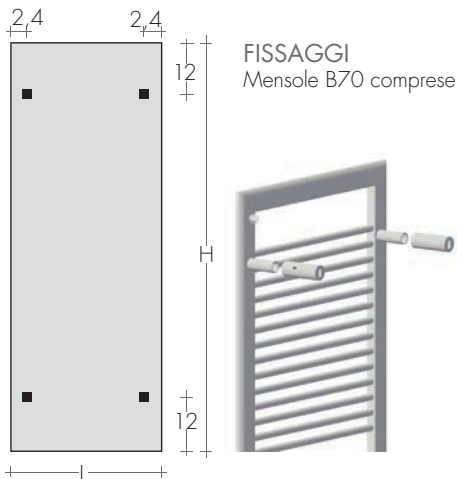
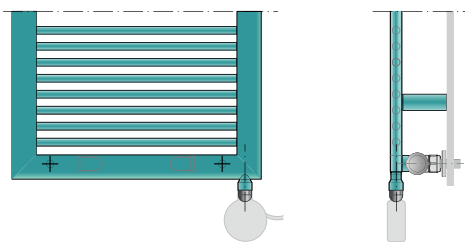

FRAC 159-39

**VALVOLE CONSIGLIATE**

KIT VALVOLE CROMATE comprende:

- n°2 Valvole con codoli
- n°2 Raccordi (per multistrato ø16 e rame ø12 e 14)
- n°2 Rosette tonde cromo ø 48, foro ø16

**FINITURE SPECIALI**

pag. 267  
Finiture Oro, Bronzo, Nickel spazzolato per 2 valvole  
KIT Raccordi NICKEL spazz. suppl.Art. RN 28,20€

**ATTACCHI REMOTI**

Art. REM 37,60€  
Interasse attacchi sul retro: ▲ L-6 cm  
Valvole REMOTE pag. 274

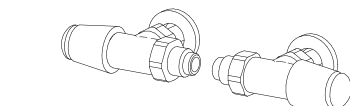

KIT VALVOLE TON REVERSE  
pag.269 Art. KVR 127,00€

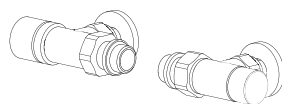

KIT VALVOLA CYL termostattabile REVERSA  
pag.273 Art. KCR 138,80€  
Colore tabella BREM supplemento 49,50€

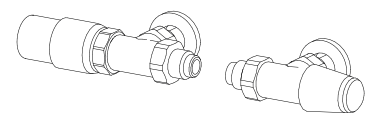

KIT VALVOLE TON REVERSE con TESTA TERMO-STATICA, pag. 269 Art. KTR 176,20€

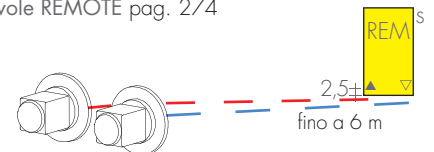

Armonia nuova nel bagno: KUAD è lo scaldasalviette con i tubi radianti quadrati

reversibile, che può essere installato con il fronte dei collettori quadro o curvo. Con

il fronte quadro dei collettori si consiglia l'installazione con le valvole Quadra.

## DIMENSIONI

Larghezze: 35 / 45 / 50 / 55 / 60 cm

Altezze: 75 / 112,5 / 150 / 175 cm

Profondità: 3,8 cm

Sporgenza dal muro: 10,5 cm

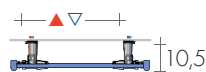
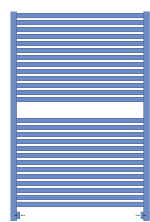

KUAD 75 - ..

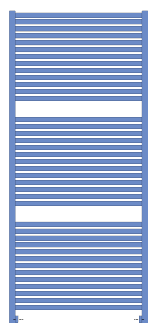

KUAD 112 - ..

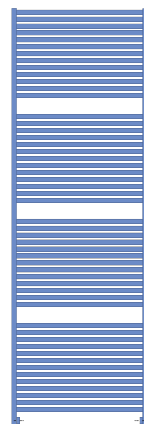

KUAD 150 - ..

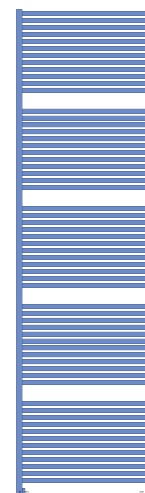

KUAD 175 - ..

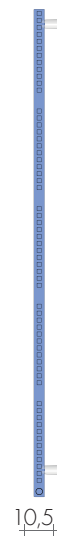

MODELLO	HL cm	Bianco di serie sablé SB 9016 €	EN 442			▲▼ int.att. cm	Altezza H cm	Larghezza L cm	Peso M Kg	Volume V dm³	VERSIONI MISTE con Resistenza e manicotto	
			Δt 50 K watt	Δt 40 K watt	Δt 30 K watt						Watt	€
KUAD	75-45	368,70	371	282	197	30,5	75	45	6,9	3,0	400	117,20
KUAD	75-50	375,30	415	315	220	35,5	75	50	7,4	3,2	400	117,20
KUAD	112-45	549,30	546	414	289	30,5	112,5	45	10,3	4,5	500	119,30
KUAD	112-50	560,00	609	462	323	35,5	112,5	50	11,1	4,8	650	121,30
KUAD	112-55	570,50	673	511	357	40,5	112,5	55	11,9	5,1	650	121,30
KUAD SLIM	150-35	671,90	553	420	293	20,5	150	35	13,7	5,9	500	119,30
KUAD	150-45	687,30	713	541	378	30,5	150	45	13,7	5,9	650	121,30
KUAD	150-50	697,20	792	601	420	35,5	150	50	14,8	6,4	800	125,70
KUAD	150-55	709,00	872	662	462	40,5	150	55	15,9	6,8	900	129,00
KUAD SLIM	175-35	758,00	643	488	341	20,5	175	35	13,4	5,9	650	121,30
KUAD	175-45	776,80	821	623	435	30,5	175	45	15,9	6,9	800	125,70
KUAD	175-50	794,30	910	691	482	35,5	175	50	17,2	7,4	900	129,00
KUAD	175-60	829,30	1088	826	577	45,5	175	60	19,7	8,4	1200	136,70

A richiesta dimensioni su misura

▶ Pronta consegna solo bianco di serie

Termostati p.208-209

KUAD è reversibile e può essere installato con il fronte dei collettori quadro (Q) o curvo (C); è costruito di serie con il fronte collettore Quadro. Specificare se il fronte del collettore è curvo (C).

ESECUZIONE  
STANDARD

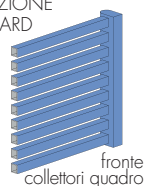

fronte  
collettori quadro

ESECUZIONE  
A RICHIESTA

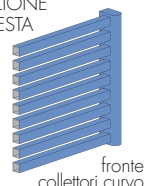

fronte  
collettori curvo

## ESECUZIONI DI SERIE

Colore bianco sablé SB9016, fissaggi M8KB  
Valvola di sfiato ø 1/8" - Tolleranze ± 3mm  
PRESSIONE MASSIMA DI ESERCIZIO 8 BAR

## ESECUZIONI A RICHIESTA

Verniciatura tabella colori Brem con fissaggi  
cromati M8KC +15/25%  
Versione elettrica e.KUAD, pag.238

## ATTACCHI DI SERIE

REG ø 1/2"  
A richiesta, attacchi ø 3/8"  
KUAD Divisorio, pag. 202

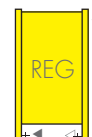

### INTERASSE ATTACCHI

Attacchi di serie REG con valvole reverse

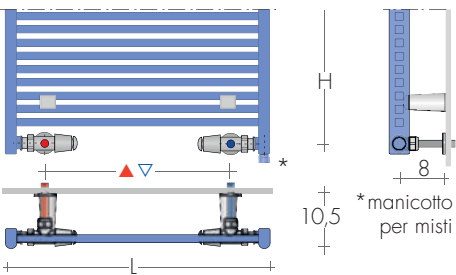

A RICHIESTA  
Attacchi EG

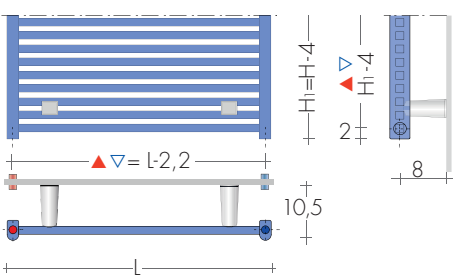

L'altezza viene ridotta di 4 cm (H1) per:  
- attacchi EG (i.a.L-2,2cm)  
- attacchi laterali (H1-4cm)  
Supplemento Art. AS 81,40€

A richiesta mensole B55 verniciate nel colore dello scaldasalviette a=1cm con profondità 9,3cm  
Supplemento 2 mensole Art. MV2 30,00€  
Supplemento 4 mensole Art. MV4 50,00€

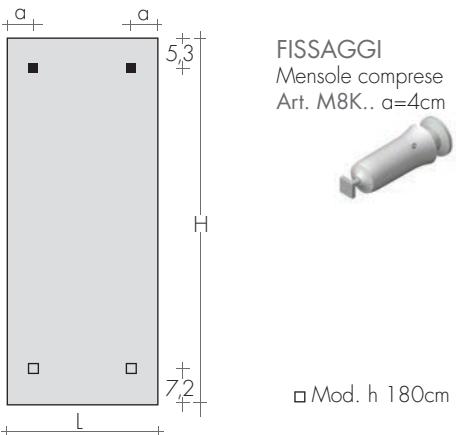

KUAD 75-50

### VALVOLE CONSIGLIATE

KIT VALVOLE CROMATE comprende:

- n°2 Valvole con codoli
- n°2 Raccordi (per multistrato ø16 e rame ø12 e 14)
- n°2 Rosette tonde cromo ø 48, foro ø16

### FINITURE SPECIALI

pag. 267  
Finiture Oro, Bronzo, Nickel spazzolato per 2 valvole  
KIT Raccordi NICKEL spazz. suppl.Art. RN 28,20€

### ATTACCHI REMOTI

Art. REM 37,60€  
Interasse attacchi sul retro: ▲▼ L-2cm  
Valvole REMOTE pag. 274

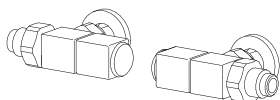

KIT VALVOLE QUADRA REVERSE  
pag.271 Art. KQR 166,80€  
Colore tabella BREM supplemento 49,50€

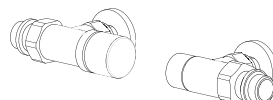

KIT VALVOLA CYL termostattabile REVERSA  
pag.273 Art. KCR 138,80€  
Colore tabella BREM supplemento 49,50€

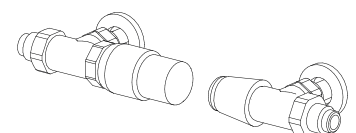
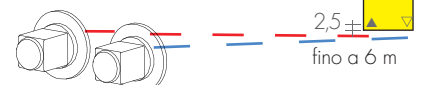

KIT VALVOLE TON REVERSE con TESTA TERMO-  
STATICA, pag. 269 Art. KTR 176,20€

I tubi sottili tondi con angoli curvati, innestati su collettori verticali, formano uno scaldasal-

viette elegante, pratico e adatto a qualsiasi bagno. Non solo la sporgenza è molto con-

tenuta ma la forma particolare e la ritmatura consentono rese superiori.

## DIMENSIONI

Larghezze: 28/50/60/75 cm

Altezze: 68,3/89,3/116,8/144,3/177,3 cm

Profondità: 6,5 cm

Sporgenza dal muro: 9,5 cm

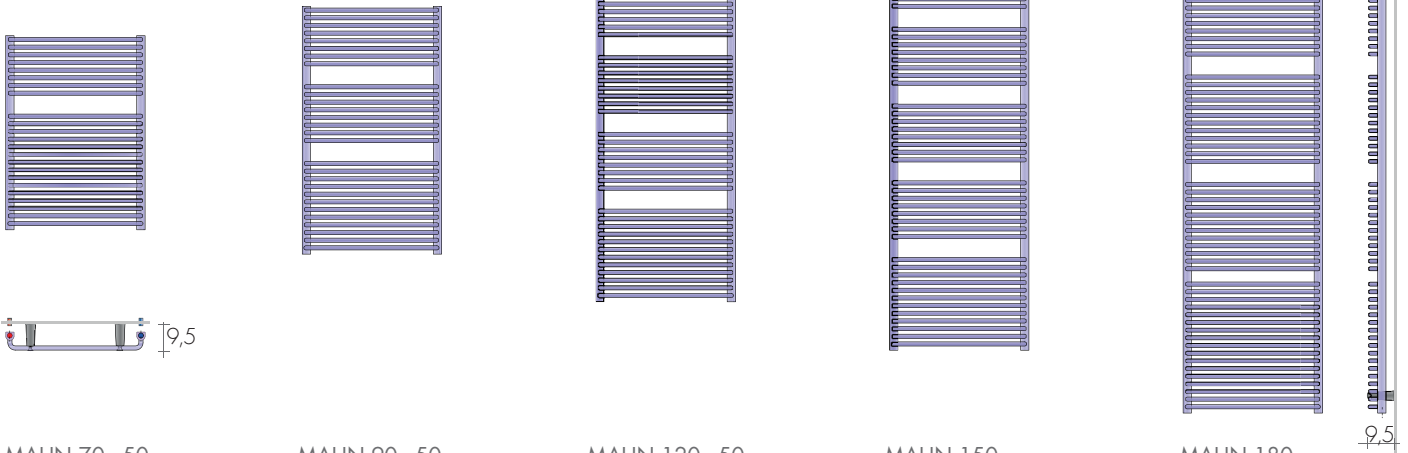

MAHN 70 - 50

MAHN 90 - 50

MAHN 120 - 50

MAHN 150 - ...

MAHN 180 - ...

MODELLO	H/L cm	Bianco di serie sablé SB 9016 €	Δt 50K watt	EN 442 Δt 40K watt	Δt 30K watt	▲ ▼ int.att. cm	Altezza H cm	Larghezza L cm	Peso M Kg	Volume V dm <sup>3</sup>	VERSIONI MISTE con Resistenza e* Watt €	
MAHN	70-50	521,40	420	317	220	47	68,3	50	5,5	3,31	400	95,70
MAHN	90-50	663,10	549	414	287	47	89,3	50	7,0	4,22	500	97,80
MAHN	120-50	788,90	684	516	358	47	116,8	50	9,0	5,47	650	99,80
Slim-MAHN	150-28	853,20	541	408	283	25	144,3	28	7,5	5,21	500	97,80
MAHN	150-50	935,10	833	629	436	47	144,3	50	11	6,73	800	104,20
MAHN	150-60	980,40	986	744	516	57	144,3	60	12,6	7,31	900	107,50
Slim-MAHN	180-28	1013,70	683	516	357	25	177,3	28	9,7	6,76	650	99,80
MAHN	180-50	1106,00	1056	797	552	47	177,3	50	13,9	8,40	1200	115,20
MAHN	180-60	1162,70	1226	926	641	57	177,3	60	15,8	9,14	1200	115,20
MAHN	180-75	1257,60	1562	1179	817	72	177,3	75	18,7	10,25	1500	125,40
MAHN-PLUS	150-50	1605,10	1604	1211	842	47	144,3	50	20,5	13,20	1500	125,40
VERSIONE CROMATA												
M-CROM	70-50	1051,90	336	254	176	47	68,3	50	5,5	3,31	300	94,60
M-CROM	90-50	1340,60	439	331	229	47	89,3	50	7,0	4,22	400	95,70
M-CROM	120-50	1593,90	547	413	286	47	116,8	50	9,0	5,47	500	97,80
M-CROM	150-50	1888,80	666	502	349	47	144,3	50	11	6,73	650	99,80
M-CROM	180-28	2043,10	546	411	285	25	177,3	28	9,7	6,76	500	97,80
M-CROM	180-50	2234,40	845	638	442	47	177,3	50	13,9	8,40	900	107,50

Finitura cromata, mensole M8C cromate

\*Aggiungere: Valvola mista o TR p.207  
Termostati p.208-209

## ESECUZIONI DI SERIE

Colore bianco sablé SB9016, fissaggi M8B  
Valvola di sfianto ø 1/8" - Tolleranze ± 3mm  
Pressione massima di esercizio 8 BAR

## ESECUZIONI A RICHIESTA

Verniciatura in una tinta della tabella colori  
Brem (fissaggi M8C cromati) +15/25%  
Versione elettrica e.Mahn, pag. 244

## ATTACCHI DI SERIE

EG ø 1/2"  
Attacchi a richiesta pag. 279  
Accessori, pag. 277



**INTERASSE ATTACCHI**  
 Attacchi serie EG verticali  
 A richiesta attacchi laterali

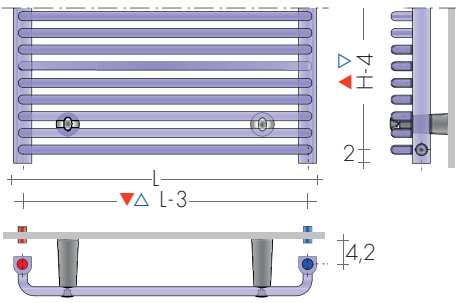

Attacchi laterali (i.a.H-4cm)  
 Supplemento Art. AS 81,40€

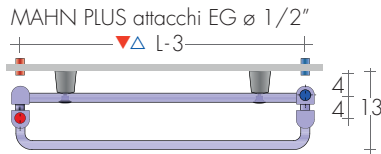

Mandata anteriore sinistra - Ritorno posteriore destro

A richiesta mensole B35 verniciate nel colore dello scaldasalviette a=1,5 cm, profondità 10cm  
 Supplemento 2 mensole Art. MV2 30,00€  
 Supplemento 4 mensole Art. MV4 50,00€

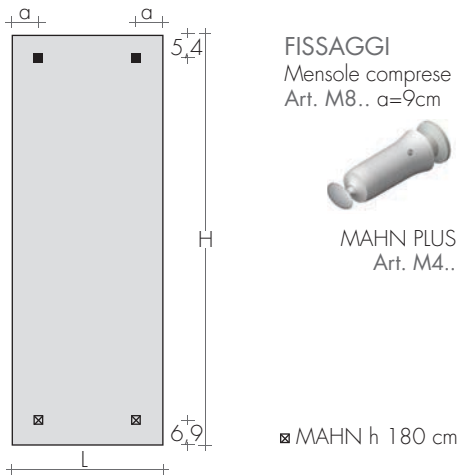

M-CROM 90-50

**VALVOLE CONSIGLIATE**

**KIT VALVOLE CROMATE** comprende:  
 - n°2 Valvole con codoli  
 - n°2 Raccordi (per multistrato ø16 e rame ø12 e 14)  
 - n°2 Rosette tonde cromo ø 48, foro ø16

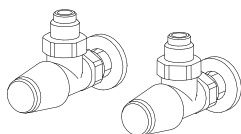

**KIT VALVOLE TON A SQUADRA**  
 pag.269 Art. KVS 127,00€

**FINITURE SPECIALI** pag. 267  
 Finiture Oro, Bronzo, Nickel spazzolato per 2 valvole  
**KIT Raccordi NICKEL** spazz. suppl.Art. RN 28,20€

A richiesta mensole B55 verniciate nel colore dello scaldasalviette a=1,5cm con profondità 10cm  
 Supplemento 2 mensole Art. MV2 40,00€  
 Supplemento 4 mensole Art. MV4 65,00€

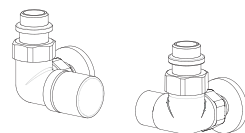

**KIT VALVOLE CYL** termostattabile con comando  
**LATERALE**, pag.273 Art. KCL 150,50€  
 Colore tabella BREM supplemento 49,50€

**ATTACCHI REMOTI** Art. REM 37,60€  
 Interasse attacchi sul retro: ▲▼ EG  
 Valvole REMOTE pag. 274

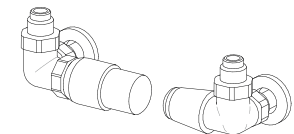
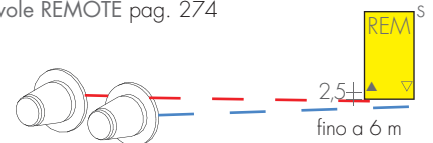

**KIT VALVOLE TON** comando **LATERALE** con testa  
**TERMOSTATICA**, pag. 269 Art. KTL 188,60€

L'armonia dei ritmi e delle alternanze di tubi tondi con angoli curvati e spazi, danno

forma ad una collezione di scaldasalviette molto pratici dal design semplice ed accatt-

vante adatto ad essere installato dal bagno della zona giorno a quello padronale.

## DIMENSIONI

Larghezze: 51/61 cm

Altezze: 82/111/112/142/155/172/180/186 cm

Profondità: 6,5 cm Sporgenza dal muro: 10 cm

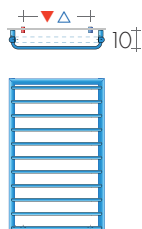

MAHN-AIR 82-51



MAHN-AIR 112-51



MAHN-AIR 142-51

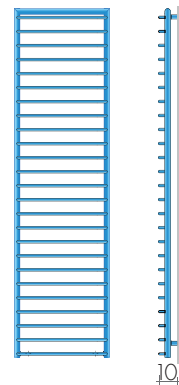

MAHN-AIR 186-51

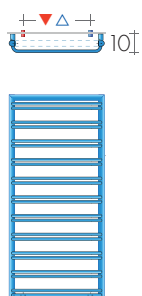

MAHN-A2R 111-51



MAHN-A2R 142-51

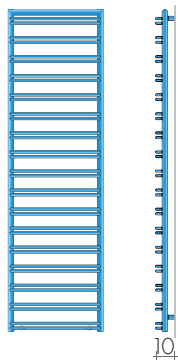

MAHN-A2R 172-51

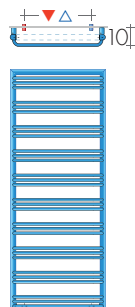

MAHN-A3R 128-51



MAHN-A3R 155-51

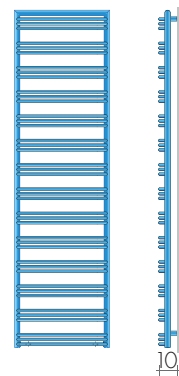

MAHN-A3R 180-51

MODELLO	H/L cm	Bianco di serie sablé SB 9016 €	EN 442			▲ ▼ int.att. cm	Altezza H cm	Larghezza L cm	Peso M Kg	Volume V dm3	VERSIONI MISTE con Resistenza e manico Watt €	
			Δt 50K watt	Δt 40K watt	Δt 30K watt						Watt	€
MAHN-AIR	82-51	469,20	294	221	154	36	81,5	51	4,0	1,8	300	116,10
MAHN-AIR	112-51	530,50	393	296	206	36	111,5	51	5,5	2,5	400	117,20
MAHN-AIR	142-51	670,50	491	370	257	36	141,5	51	6,9	3,2	500	119,30
MAHN-AIR	186-51	774,20	638	480	334	36	186,5	51	9,1	4,2	650	121,30
MAHN-AIR	186-61	813,90	716	539	374	46	186,5	61	10,0	4,5	650	121,30
MAHN-A2R	111-51	629,90	503	379	263	36	111	51	6,7	3	500	119,30
MAHN-A2R	142-51	749,40	633	477	331	36	141,6	51	8,6	3,8	650	121,30
MAHN-A2R	172-51	829,50	764	575	400	36	172,2	51	10,4	4,7	800	125,70
MAHN-A2R	172-61	872,00	868	654	454	46	172,2	61	11,6	5,1	900	129,00
MAHN-A3R	128-51	769,50	650	489	340	36	128,5	51	8,7	3,8	650	121,30
MAHN-A3R	155-51	841,50	775	584	405	36	154,5	51	10,4	4,6	800	125,70
MAHN-A3R	180-51	904,20	900	678	471	36	180,5	51	12,1	5,4	900	129,00
MAHN-A3R	180-61	1041,70	1027	773	537	46	180,5	61	13,6	5,9	-	-

Termostati p.208-209

## ESECUZIONI DI SERIE

Colore bianco sablé SB9016, fissaggi B35  
Valvola di sfiato ø 1/8" - Tolleranze ± 3mm  
PRESSIONE MASSIMA DI ESERCIZIO 8 BAR

## ESECUZIONI A RICHIESTA

Verniciatura tabella colori Brem con fissaggi  
B35 colorati +15/25%  
Versione elettrica e.Mahn-AIR pag.245

## ATTACCHI DI SERIE

REG ø 1/2"  
A richiesta, attacchi ø 3/8"  
Attacchi a richiesta pag. 279



INTERASSE ATTACCHI

Attacchi di serie REG con valvole reverse

MAHN-AIR

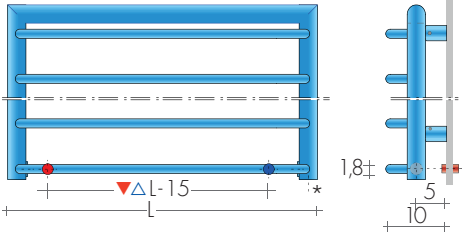

MAHN-A2R

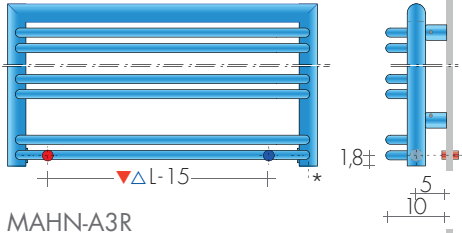

MAHN-A3R

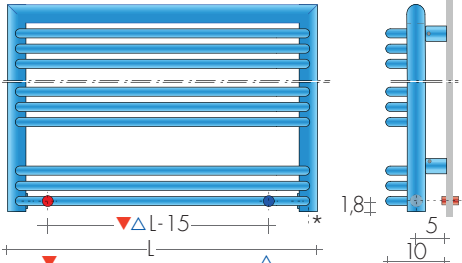

\*R.E.  
versioni miste

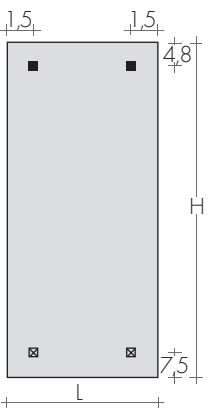

FISSAGGI  
Mensole B35 comprese

VALVOLE CONSIGLIATE

KIT VALVOLE CROMATE comprende:

- n°2 Valvole con codoli
- n°2 Raccordi (per multistrato ø16 e rame ø12 e 14)
- n°2 Rosette tonde cromo ø 48, foro ø16

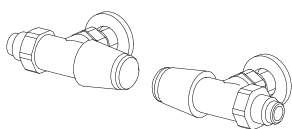

KIT VALVOLE TON REVERSE  
p.269 Art. KVR 127,00€

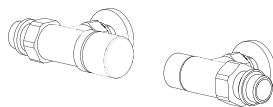

KIT VALVOLA CYL termostattabile REVERSA  
pag. 273 Art. KCR 138,80€  
Colore tabella BREM supplemento 49,50€



ATTACCHI REMOTI Art. REM 37,60€  
Interasse attacchi sul retro: ▲▽ L -3cm  
Valvole REMOTE pag. 274

KIT VALVOLE TON REVERSE con TESTA TERMO-  
STATICA, pag. 269 Art. KTR 176,20€



MAHN-AIR 142-51

MAHN-A2R 142-51

MAHN-A3R 155-51

PLANK è lo scaldasalviette a tubi quadri 20 x 20 mm e collettori tondi, dal design moderno

che si adatta a tutte le ambientazioni, proposto in quattro altezze e sei larghezze,

può soddisfare ogni richiesta di calorie per riscaldare il bagno.

## DIMENSIONI

Larghezze: 40/50/60/120 cm

Altezze: 44/52/88/124/172/180 cm

Profondità: 5 cm

Sporgenza dal muro: 8 cm

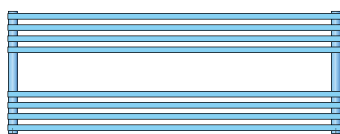

PLANK 45 - 120



PLANK 50 - 120

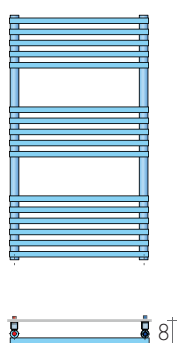

PLANK 90 - ..

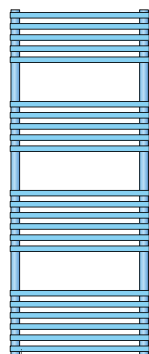

PLANK 125 - ..

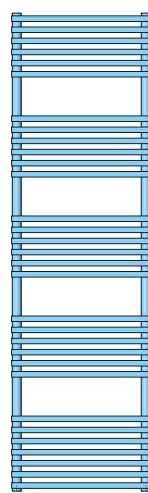

PLANK 170 - ..

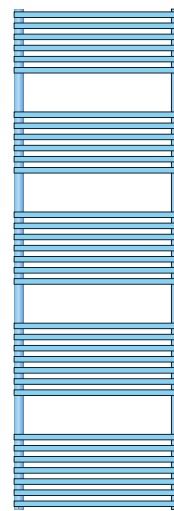

PLANK 180 - 60

MODELLO	H-L cm	Bianco di serie sablé SB 9016 €	EN 442			▲ ▼ int.att. cm	Altezza H cm	Larghezza L cm	Peso M Kg	Volume V dm <sup>3</sup>	VERSIONI MISTE con	
			Δt 50K watt	Δt 40K watt	Δt 30K watt						Resistenza e* Watt	€
PLANK	45-120	410,80	489	369	257	117	44	120	8,4	3,5	-	-
PLANK	50-120	443,80	608	459	320	117	52	120	10,5	4,4	-	-
PLANK	90-40	326,60	▶ 390	294	205	37	88	40	7,0	3,1	400	95,70
PLANK	90-50	339,00	▶ 463	350	244	47	88	50	8,2	3,6	500	97,80
PLANK	125-40	437,00	▶ 539	407	284	37	124	40	9,6	4,3	500	97,80
PLANK	125-50	452,10	▶ 640	483	337	47	124	50	11,4	5,0	650	99,80
PLANK	125-60	467,10	741	559	390	57	124	60	13,1	5,7	800	104,20
PLANK	170-40	598,00	▶ 757	572	398	37	172	40	13,5	6,0	800	104,20
PLANK	170-50	621,60	▶ 899	679	473	47	172	50	15,9	7,0	900	107,50
PLANK	180-60	681,90	1110	838	584	57	180	60	19,4	8,4	1200	115,20

▶ Pronta consegna solo bianco di serie

\*Aggiungere: Valvola mista o TR p.207  
Termostati p.208-209

## ESECUZIONI DI SERIE

Colore bianco sablé SB9016, fissaggi G30;  
Tolleranze ± 3mm - Valvola di sfianto ø 1/2"  
PRESSIONE MASSIMA DI ESERCIZIO 8 BAR

## ESECUZIONI A RICHIESTA

Verniciatura tabella colori Brem con fissaggi  
G30 colorati +1,5/25%  
Versione elettrica e.PLANK pag.249

## ATTACCHI DI SERIE

EG ø 1/2"



INTERASSE ATTACCHI

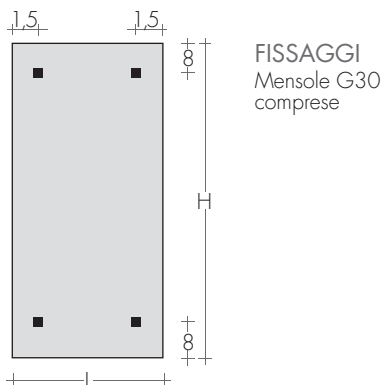
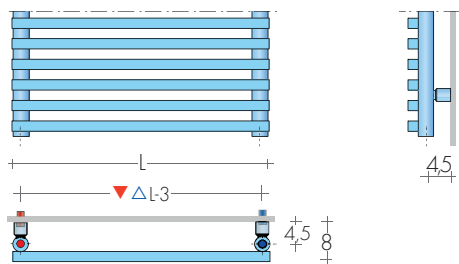

VALVOLE CONSIGLIATE

KIT VALVOLE CROMATE comprende:

- n°2 Valvole con codoli
- n°2 Raccordi (per multistrato ø16 e rame ø12 e 14)
- n°2 Rosette tonde cromo ø 48, foro ø16

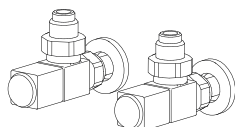

KIT VALVOLE QUADRA A SQUADRA  
pag.271 Art. KQS 166,80€  
Colore tabella BREM supplemento 49,50€

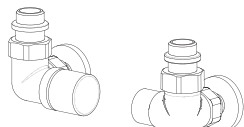

KIT VALVOLE CYL termostaticabile con comando  
LATERALE, pag.273 Art. KCL 150,50€  
Colore tabella BREM supplemento 49,50€

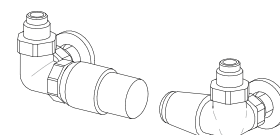
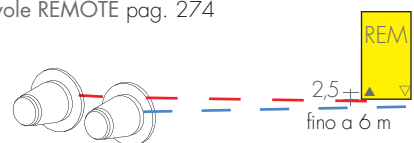

KIT VALVOLE TON comando LATERALE con testa  
TERMOSTATICA, pag. 269 Art. KTL 188,60€

PLANK-AIR è lo scaldasalviette a tubi quadri 20 x 20 mm e collettori tondi, dal design

contemporaneo che si adatta a tutte le ambientazioni; proposto in cinque altezze

e quattro larghezze, può soddisfare ogni richiesta di calorie per riscaldare il bagno.

## DIMENSIONI

Larghezze: 40/50/60/120 cm

Altezze: 44/60/92/116/156/180 cm

Profondità: 5 cm

Sporgenza dal muro: 8 cm



PLANK-AIR 44 - 120



PLANK-AIR 60 - 120

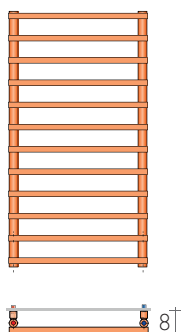

PLANK-AIR 92 - ..

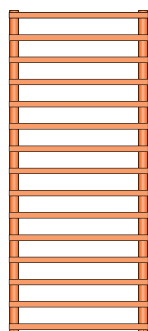

PLANK-AIR 116 - ..

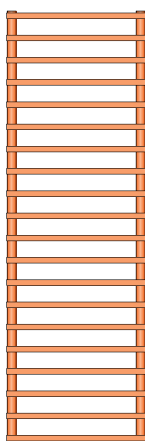

PLANK-AIR 156 - ..

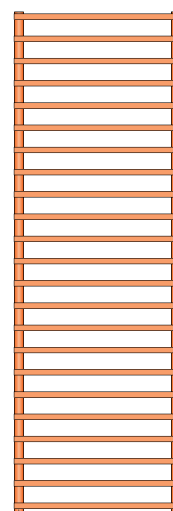

PLANK-AIR 180 - 60



MODELLO	H-L cm	Bianco di serie sablé SB 9016 €	EN 442			▲ ▼ int.att. cm	Altezza H cm	Larghezza L cm	Peso M Kg	Volume V dm <sup>3</sup>	VERSIONI MISTE con	
			Δt50K watt	Δt40K watt	Δt30K watt						Resistenza e* Watt	€
PLANK-AIR	44-120	371,50	379	286	199	117	44	120	6,6	2,8	-	-
PLANK-AIR	60-120	423,70	507	383	267	117	60	120	8,8	3,7	-	-
PLANK-AIR	92-40	293,90	321	242	169	37	92	40	5,8	2,7	300	94,60
PLANK-AIR	92-50	315,10	376	284	198	47	92	50	6,7	3,0	400	95,70
PLANK-AIR	116-40	358,30	402	304	211	37	116	40	7,3	3,3	400	95,70
PLANK-AIR	116-50	398,30	471	356	248	47	116	50	8,5	3,8	500	97,80
PLANK-AIR	156-40	443,30	537	405	282	37	156	40	9,8	4,5	500	97,80
PLANK-AIR	156-50	471,80	629	475	331	47	156	50	11,3	5,1	650	99,80
PLANK-AIR	156-60	499,45	721	544	379	57	156	60	12,9	5,7	800	104,20
PLANK-AIR	180-40	528,40	618	467	325	37	180	40	11,2	5,1	650	99,80
PLANK-AIR	180-50	545,40	724	547	381	47	180	50	13,0	5,9	800	104,20
PLANK-AIR	180-60	579,60	830	627	437	57	180	60	14,8	6,6	900	107,50

\*Aggiungere: Valvola mista o TR p.207  
Termostati p.208-209

## ESECUZIONI DI SERIE

Colore bianco sablé SB9016, fissaggi G30; valvola di sfiato ø 1/2"

PRESSIONE MASSIMA DI ESERCIZIO 8 BAR

## ESECUZIONI A RICHIESTA

Verniciatura tabella colori Brem con fissaggi G30 colorati +15/25%

Versione elettrica e.PLANK-AIR pag.249

## ATTACCHI DI SERIE

EG ø 1/2"



INTERASSE ATTACCHI

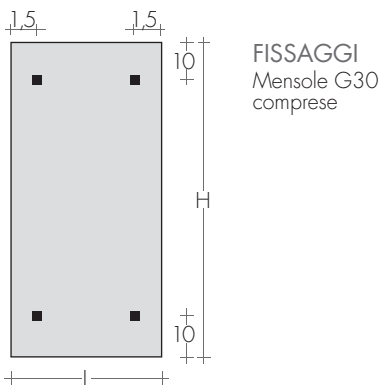
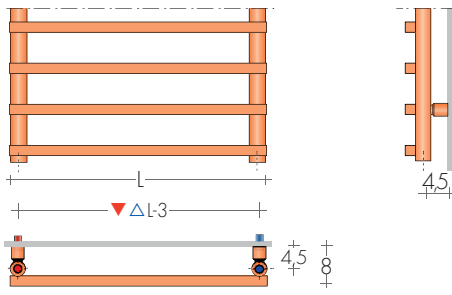

PLANK-AIR 156-50

VALVOLE CONSIGLIATE

KIT VALVOLE CROMATE comprende:

- n°2 Valvole con codoli
- n°2 Raccordi (per multistrato ø16 e rame ø12 e 14)
- n°2 Rosette tonde cromo ø 48, foro ø16

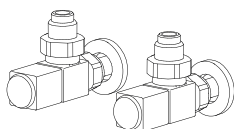

KIT VALVOLE QUADRA A SQUADRA  
pag.271 Art. KQS 166,80€  
Colore tabella BREM supplemento 49,50€

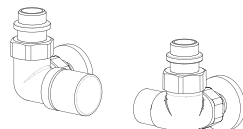

KIT VALVOLE CYL termostatabile con comando  
LATERALE, pag.273 Art. KCL 150,50€  
Colore tabella BREM supplemento 49,50€

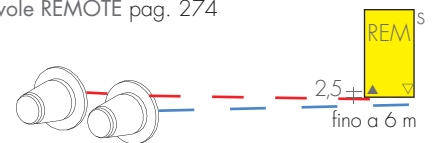

ATTACCHI REMOTI Art. REM 37,60€  
Interasse attacchi sul retro: ▲▼ EG  
Valvole REMOTE pag. 274

KIT VALVOLE TON comando LATERALE con testa  
TERMOSTATICA, pag. 269 Art. KTL 188,60€

Lo scaldasalviette PLUS 12 è prodotto con tubi sottili ø12 che emettono altissime rese.

I collettori, in tubi rotondi, dalla dimensione contenuta, rendono lo scaldasalviette meno

invasivo nell'ambiente. PLUS 12, è prodotto in tutte le tinte della cartella colori Brem.

## DIMENSIONI

Larghezze: 40/50/60/75 cm

Altezze: 85/115/145/175 cm

Profondità: 4 cm

Sporgenza dal muro: 9 cm

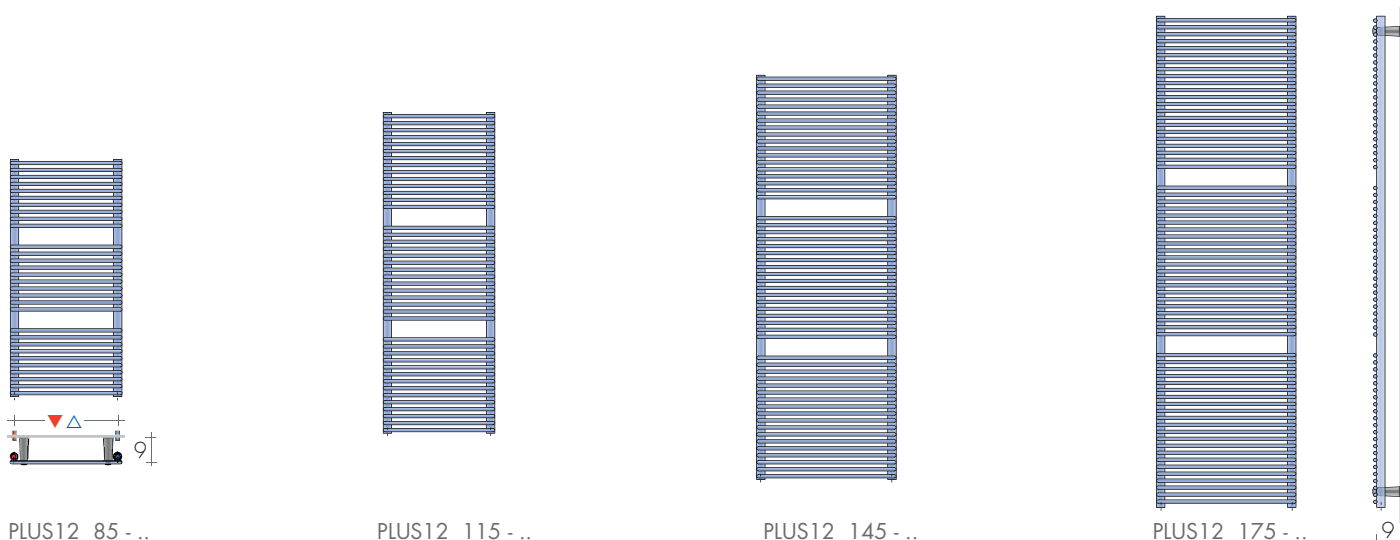

PLUS12 85 - ..

PLUS12 115 - ..

PLUS12 145 - ..

PLUS12 175 - ..

MODELLO	HxL cm	Bianco di serie sablé SB9016 €	EN 442			▲ ▽ int.att. cm	Altezza		Peso M Kg	Volume V dm³	VERSIONI MISTE con Resistenza e* Watt €	
			Δt 50K watt	Δt 40K watt	Δt 30K watt		H cm	L cm			Resistenza e* Watt	€
PLUS 12	85-40	351,90	382	291	205	37	85	40	5	1,9	400	95,70
PLUS 12	85-50	358,50	455	347	244	47	85	50	5,8	2,2	500	97,80
PLUS 12	115-40	500,50	531	405	285	37	115	40	7,0	2,6	500	97,80
PLUS 12	115-50	515,10	633	482	339	47	115	50	8,1	3,0	650	99,80
PLUS 12	145-40	573,70	679	517	364	37	145	40	8,9	3,4	650	99,80
PLUS 12	145-50	591,60	812	619	435	47	145	50	10,3	3,8	800	104,20
PLUS 12	145-60	614,00	944	719	506	57	145	60	11,8	4,2	900	107,50
PLUS 12	175-40	655,70	828	631	444	37	175	40	10,8	4,1	800	104,20
PLUS 12	175-50	686,50	990	754	531	47	175	50	12,6	4,6	900	107,50
PLUS 12	175-60	704,00	1151	877	617	57	175	60	14,4	5,1	1200	115,20
PLUS 12	175-75	796,60	1394	1062	747	72	175	75	17,0	5,9	1500	125,40

▶ Pronta consegna solo bianco di serie

\*Aggiungere: Valvola mista o TR p.207  
Termostati p.208-209

## ESECUZIONI DI SERIE

Colore bianco sablé SB9016, fissaggi M8GB  
Valvola di sfiato ø 1/2" - Tolleranze ± 3mm  
PRESSIONE MASSIMA DI ESERCIZIO 6 BAR

## ESECUZIONI A RICHIESTA

Verniciatura tabella colori Brem  
con fissaggi cromati M8GC +15/25%  
Versione elettrica e.Plus12, pag.251

## ATTACCHI DI SERIE

EG ø 1/2"  
Accessori, pag.277



INTERASSE ATTACCHI

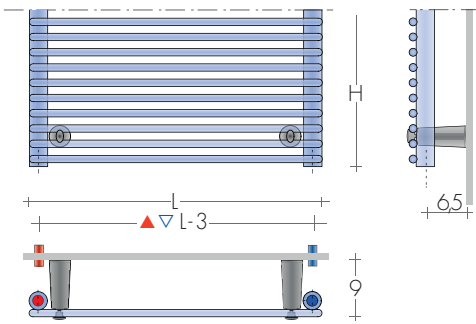

A richiesta mensole G40 verniciate nel colore dello scaldasalviette a=1,5cm con profondità 8,4cm  
 Supplemento 2 mensole Art. MV2 30,00€  
 Supplemento 4 mensole Art. MV4 50,00€

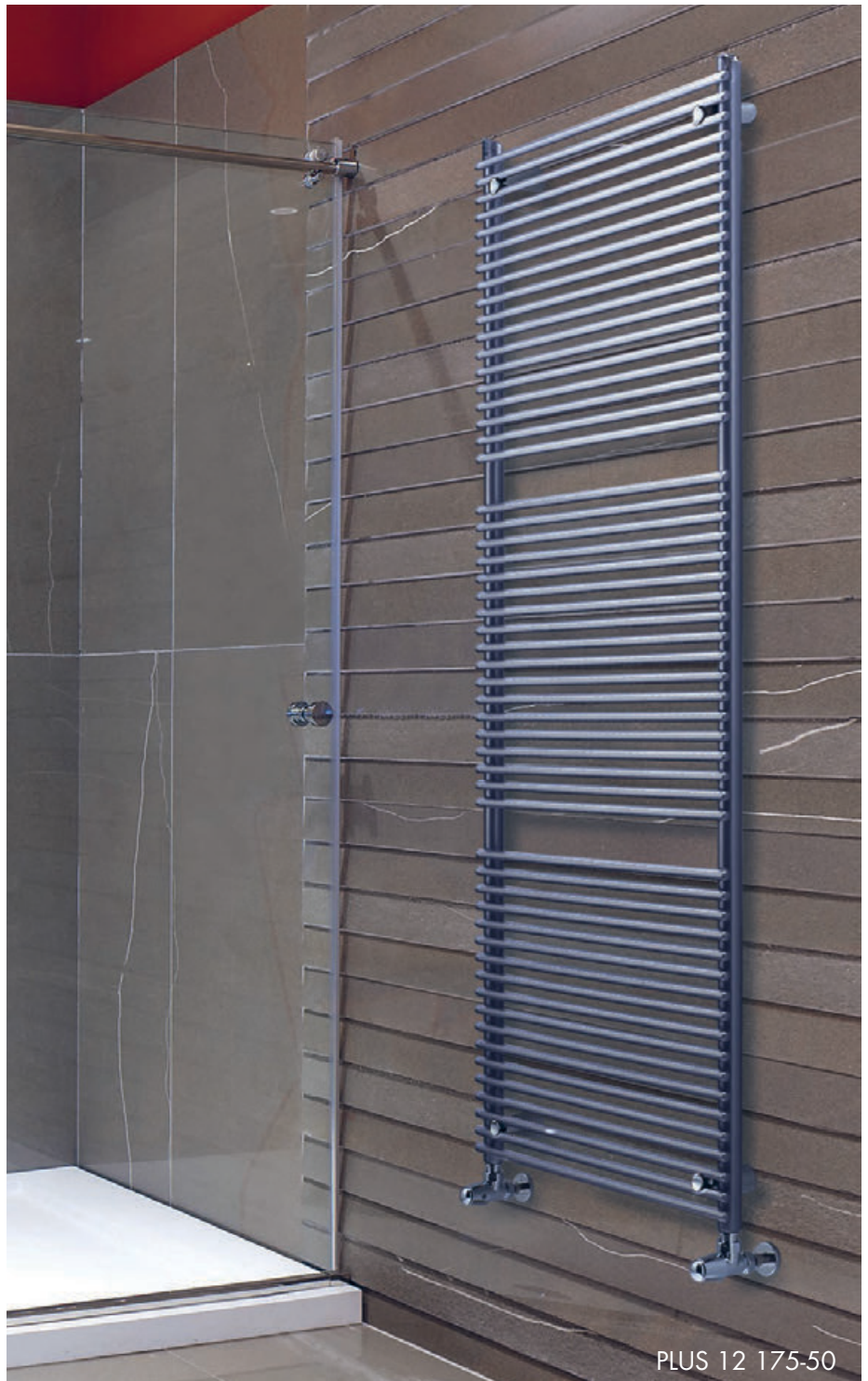
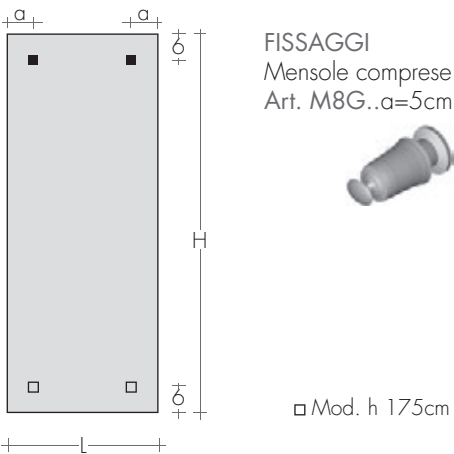

VALVOLE CONSIGLIATE

KIT VALVOLE CROMATE comprende:  
 - n°2 Valvole con codoli  
 - n°2 Raccordi (per multistrato ø16 e rame ø12 e 14)  
 - n°2 Rosette tonde cromo ø 48, foro ø16

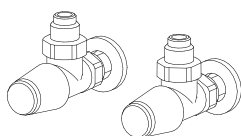

KIT VALVOLE TON A SQUADRA  
 pag.269 Art. KVS 127,00€

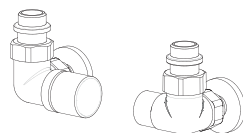

KIT VALVOLE CYL termostattabile con comando  
 LATERALE, pag.273 Art. KCL 150,50€  
 Colore tabella BREM supplemento 49,50€

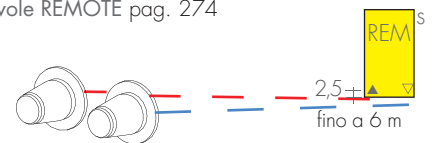

ATTACCHI REMOTI Art. REM 37,60€  
 Interasse attacchi sul retro: ▲▼ EG  
 Valvole REMOTE pag. 274

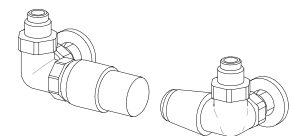

KIT VALVOLE TON comando LATERALE con testa  
 TERMOSTATICA, pag. 269 Art. KTL 188,60€

Scaldasalviette dal disegno classico adatto per essere installato in qualsiasi sala bagno.

Realizzato con i collettori verticali ed i tubi orizzontali tondi è disponibile in sei altezze

e quattro larghezze. I tubi radianti hanno i terminali dall'esclusiva forma sferica.

## DIMENSIONI

Larghezze: 42/ 52/ 62 cm

Altezze: 79,2/122,4/158,4/180 cm

Profondità: 4,7 cm

Sporgenza dal muro: 8,9 cm

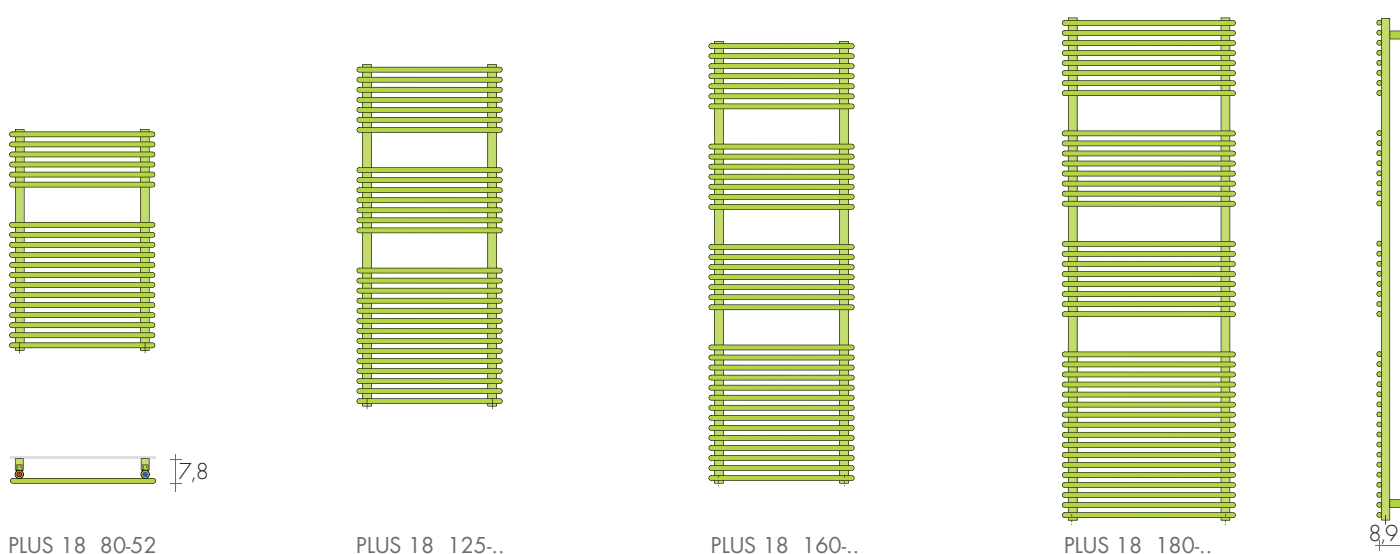

MODELLO	HL cm	Bianco di serie sablé SB9016 €	EN 442			▲ ▼ int.att. cm	Altezza H cm	Larghezza L cm	Peso M Kg	Volume V dm <sup>3</sup>	VERSIONI MISTE con	
			Δt 50 K watt	Δt 40 K watt	Δt 30 K watt						Resistenza e* Watt	€
PLUS 18	80-52	270,00	408	310	217	45	79,2	52	7,2	2,9	400	95,70
PLUS 18	125-42	339,00	516	392	275	35	122,4	42	9,2	3,8	500	97,80
PLUS 18	125-52	351,60	607	462	324	45	122,4	52	10,7	4,3	650	99,80
PLUS 18	160-42	408,10	650	494	346	35	158,4	42	11,6	4,8	650	99,80
PLUS 18	160-52	426,90	764	581	407	45	158,4	52	13,5	5,5	800	104,20
PLUS 18	160-62	447,00	878	668	468	55	158,4	62	15,5	6,2	900	107,50
PLUS 18	180-42	480,90	756	575	403	35	180	42	13,5	5,6	800	104,20
PLUS 18	180-52	502,30	889	676	474	45	180	52	15,7	6,4	900	107,50
PLUS 18	180-62	523,70	1022	777	545	55	180	62	18,0	7,2	1200	115,20

▶ Pronta consegna solo bianco di serie

\*Aggiungere: Valvola mista o TR p.207  
Termostati p.208-209

## ESECUZIONI DI SERIE

Colore bianco sablé SB9016, mensola G40  
Tolleranze ± 3mm - valvola di sfianto ø 1/2"  
PRESSIONE MASSIMA DI ESERCIZIO 8 BAR

## ESECUZIONI A RICHIESTA

Verniciatura tabella colori Brem con fissaggi colorati G40 +15/25%  
Versione elettrica e.PLUS 18 pag.252

## ATTACCHI DI SERIE

EG ø 1/2"



INTERASSE ATTACCHI

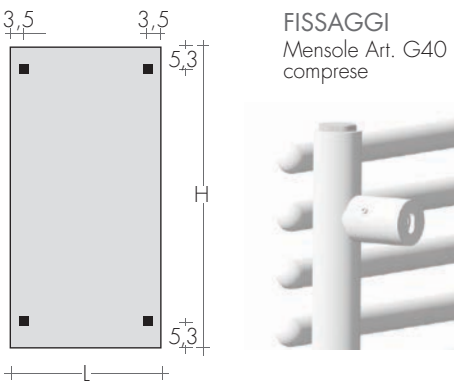
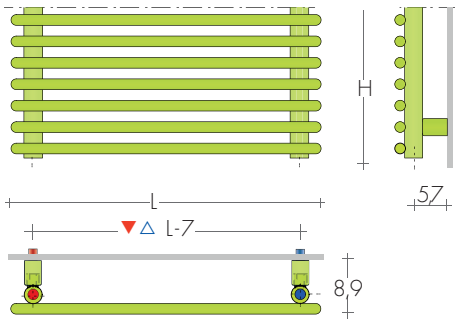

FISSAGGI  
Mensole Art. G40  
comprese



PLUS 18 125-52

VALVOLE CONSIGLIATE

KIT VALVOLE CROMATE comprende:

- n°2 Valvole con codoli
- n°2 Raccordi (per multistrato ø16 e rame ø12 e 14)
- n°2 Rosette tonde cromo ø 48, foro ø16

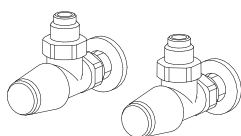

KIT VALVOLE TON A SQUADRA  
pag.269 Art. KVS 127,00€

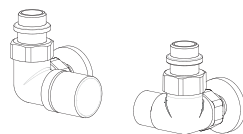

KIT VALVOLE CYL termostattabile con comando  
LATERALE, pag.273 Art. KCL 150,50€  
Colore tabella BREM supplemento 49,50€

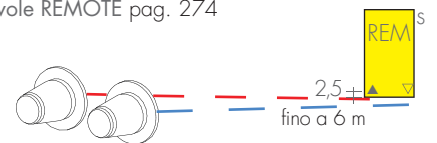

ATTACCHI REMOTI Art. REM 37,60€  
Interasse attacchi sul retro: ▲▼ EG  
Valvole REMOTE pag. 274

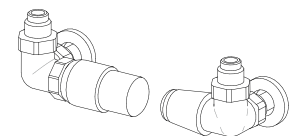

KIT VALVOLE TON comando LATERALE con testa  
TERMOSTATICA, pag. 269 Art. KTL 188,60€

Scaldasalviette dal disegno classico adatto per essere installato in qualsiasi sala bagno.

Realizzato con i collettori verticali ed i tubi orizzontali tondi è disponibile in sei altezze

e quattro larghezze. I tubi radianti hanno i terminali dall'esclusiva forma sferica.

## DIMENSIONI

Larghezze: 42 / 52 / 62 cm

Altezze: 101/136/171/185 cm

Profondità: 4,7 cm

Sporgenza dal muro: 7,8 cm

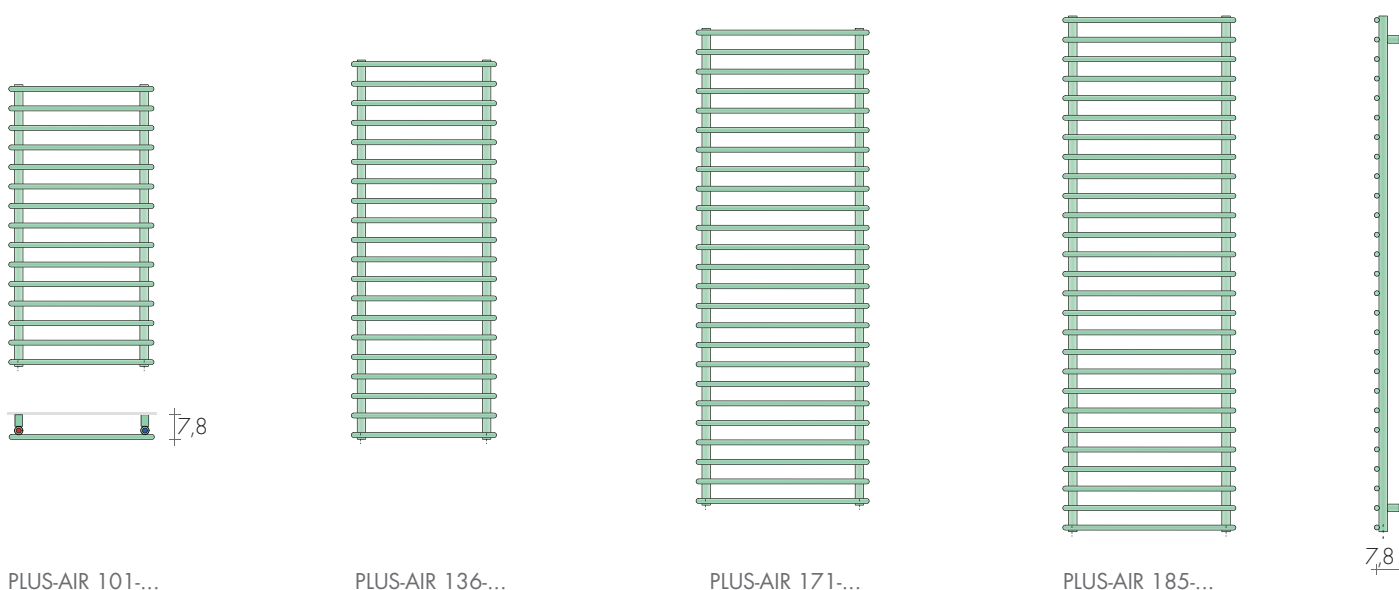

MODELLO	H/L cm	Bianco di serie sablé SB9016 €	EN 442			▲ ▼ int.att. cm	Altezza H cm	Larghezza L cm	Peso M Kg	Volume V dm <sup>3</sup>	VERSIONI MISTE con Resistenza e* Watt €	
			Δt 50 K watt	Δt 40 K watt	Δt 30 K watt						Watt	€
PLUS-AIR	101-42	288,20	314	239	167	35	101	42	2,5	5,7	300	94,60
PLUS-AIR	101-52	298,90	363	276	193	45	101	52	2,8	6,6	400	95,70
PLUS-AIR	136-42	328,90	420	319	224	35	136	42	3,3	7,7	400	95,70
PLUS-AIR	136-52	341,10	485	369	259	45	136	52	3,7	8,8	500	97,80
PLUS-AIR	171-42	371,40	526	400	280	35	171	42	4,2	9,6	500	97,80
PLUS-AIR	171-52	388,50	608	462	324	45	171	52	4,7	11	650	99,80
PLUS-AIR	171-62	406,80	689	524	367	55	171	62	5,1	12,4	650	99,80
PLUS-AIR	185-42	408,80	569	433	303	35	185	42	4,5	10,4	500	97,80
PLUS-AIR	185-52	426,90	657	500	350	45	185	52	5,0	11,9	650	99,80
PLUS-AIR	185-62	445,20	744	566	397	55	185	62	5,6	13,4	800	104,20

\*Aggiungere: Valvola mista o TR p.207  
Termostati p.208-209

## ESECUZIONI DI SERIE

Colore bianco sablé SB9016; mensola G30  
Tolleranze ± 2mm - valvola di sfriato ø 1/2"  
PRESSIONE MASSIMA DI ESERCIZIO 8 BAR

## ESECUZIONI A RICHIESTA

Verniciatura tabella colori Brem con fissaggi  
G 30 colorati +1,5/25%  
Versione elettrica e.PlusAIR pag.252

## ATTACCHI DI SERIE

EG ø 1/2"



INTERASSE ATTACCHI

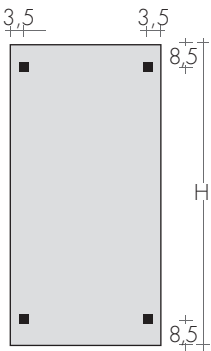
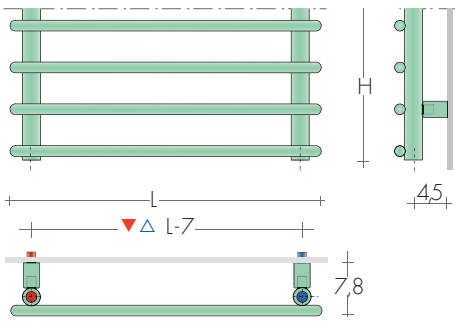

**FISSAGGI**  
Mensole Art. G30  
comprese



PLUS-AIR 171-52

**VALVOLE CONSIGLIATE**

KIT VALVOLE CROMATE comprende:

- n°2 Valvole con codoli
- n°2 Raccordi (per multistrato ø16 e rame ø12 e 14)
- n°2 Rosette tonde cromo ø 48, foro ø16

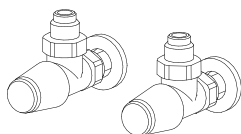

KIT VALVOLE TON A SQUADRA  
pag.269 Art. KVS

127,00€

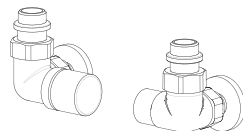

KIT VALVOLE CYL termostattabile con comando  
LATERALE, pag.273 Art. KCL 150,50€  
Colore tabella BREM supplemento 49,50€

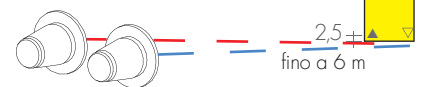

ATTACCHI REMOTI Art. REM 37,60€  
Interasse attacchi sul retro: ▲▼ EG  
Valvole REMOTE pag. 274

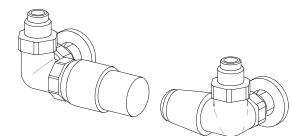

KIT VALVOLE TON comando LATERALE con testa  
TERMOSTATICA, pag. 269 Art. KTL 188,60€

# RAW

## MODELLI VERTICALI

PREZZI DAL 01.03.2026 + 5%

RAW, è un prodotto estremamente iconico, realizzato con tubi tondi  $\varnothing$  25 mm curvati,

e saldati a formare dei box caratterizzati dall'incrocio dei tubi centrali.

design Davide Diliberto  
Una forma senza forma, tridimensionale, vuota, un traliccio che ricorda elementi da costruzioni.



A'DESIGN AWARD  
WINNER 2019  
GOLD

### DIMENSIONI

Larghezze: 50/77 cm

Altezze: 50/77/104/130/157/183/210 cm

Profondità: 10 cm

Sporgenza dal muro: 13,5 cm

### RAW1

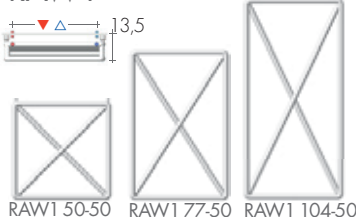

### RAW2

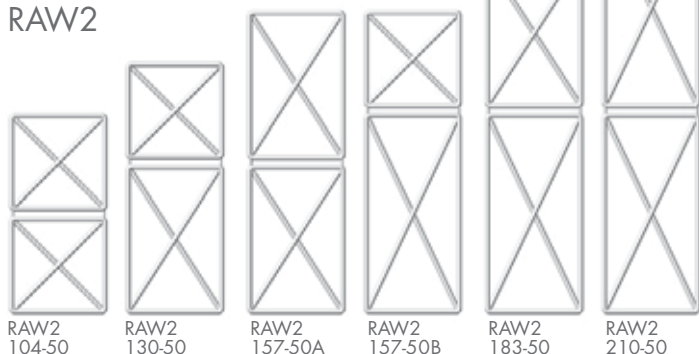

### RAW3

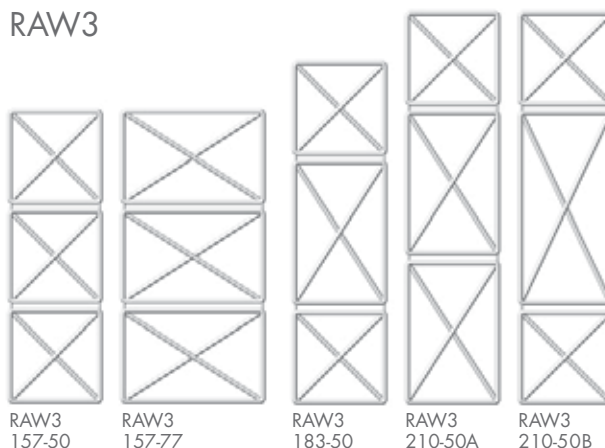

### MODELLI VERTICALI

MODELLO	H-L cm	Bianco di serie sablé SB9016 €	EN 442			▲▼ int.att. cm	Altezza H cm	Larghezza L cm	Peso M Kg	Volume V dm <sup>3</sup>	VERSIONI MISTE con Resistenza e manicotto	
			Δt 50 K watt	Δt 40 K watt	Δt 30 K watt						Watt	€
RAW1	50-50	565,10	287	219	155	42	50,5	50,5	4,4	2,1	300	116,10
RAW1	77-50	653,00	356	272	192	42	77,0	50,5	5,5	2,7	400	117,20
RAW1	104-50	728,40	421	320	224	42	103,5	50,5	6,7	3,3	400	117,20
RAW2	104-50	941,90	578	440	308	42	103,5	50,5	8,8	4,3	500	119,30
RAW2	130-50	998,30	647	539	342	42	130,0	50,5	9,9	4,9	650	121,30
RAW2	157-50A	1054,80	712	539	376	42	156,5	50,5	11,1	5,5	800	125,70
RAW2	157-50B	1054,80	717	543	379	42	156,5	50,5	11,1	5,4	800	125,70
RAW2	183-50	1086,20	782	592	413	42	183,0	50,5	12,3	6,0	800	125,70
RAW2	210-50	1130,20	846	637	442	42	209,5	50,5	13,5	6,6	900	129,00
RAW3	157-50	1318,60	868	657	458	42	156,5	50,5	13,2	6,4	900	129,00
RAW3	157-77	1381,40	1077	815	569	68,5	156,5	77,0	16,6	8,2	1200	115,20
RAW3	183-50	1343,70	938	710	495	42	183,0	50,5	14,3	7,0	900	129,00
RAW3	210-50A	1356,30	1003	755	525	42	209,5	50,5	15,5	7,6	900	129,00
RAW3	210-50B	1356,30	1007	758	527	42	209,5	50,5	15,5	7,6	900	129,00

Altre misure e con elementi larghi 60 cm su richiesta

Termostati p.228-229

VERSIONI MISTE  
attacco EG ▲▼ 5 cm

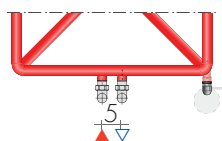

### ESECUZIONI DI SERIE

Colore bianco sablé SB9016 fissaggi B35  
Tolleranze  $\pm$  3mm - Valvola di sfianto  $\varnothing$  1/8"  
PRESSIONE MASSIMA D'ESERCIZIO 8 BAR

### ESECUZIONI A RICHIESTA

Verniciatura tabella colori Brem con mensole  
B35 colorate +15/25%  
Versione elettrica, e.Raw pag. 254

### ATTACCHI DI SERIE EG $\varnothing$ 1/2"

A richiesta attacchi  $\varnothing$  3/8"  
Piedini e divisori a richiesta  
Attacchi speciali, pag. 278



### INTERASSE ATTACCHI

Attacchi serie EG verticali

A richiesta attacchi laterali senza supplemento

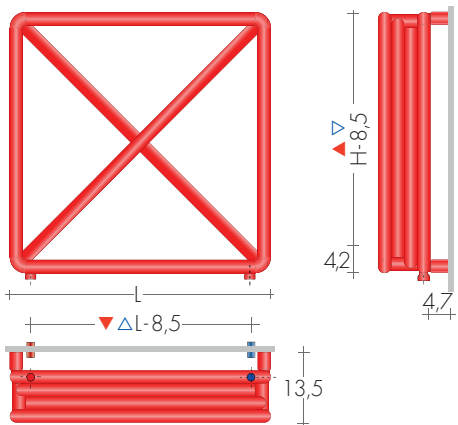

### PROGETTA IL TUO CALORIFERO COMPONENDO I MODULI BASE

Richiedere fattibilità e preventivo

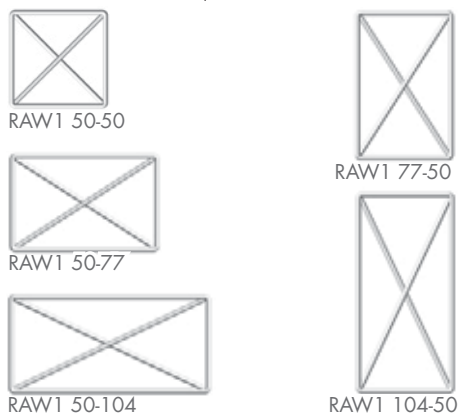

### FISSAGGI

Mensole comprese

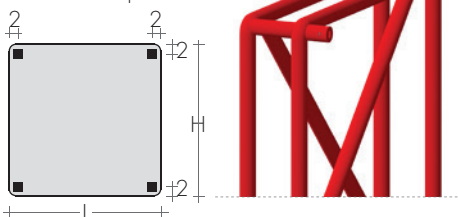

### VALVOLE CONSIGLIATE

KIT VALVOLE CROMATE comprende:

- n°2 Valvole con codoli
- n°2 Raccordi (per multistrato ø16 e rame ø12 e 14)
- n°2 Rosette tonde cromo ø 48, foro ø16

### FINITURE SPECIALI

pag. 267  
Finiture Oro, Bronzo, Nickel spazzolato per 2 valvole

KIT Raccordi NICKEL spazz. suppl.Art. RN 28,20€

### ATTACCHI REMOTI

Art. REM 37,60€

Interasse attacchi sul retro: ▲▼ EG

Valvole REMOTE pag. 274

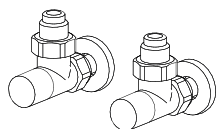
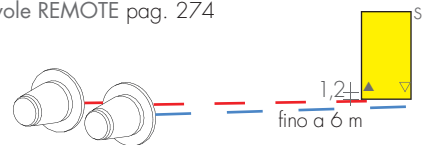

KIT VALVOLE MINI A SQUADRA pag.270  
cromo o colore bianco Art. KMS 114,80€

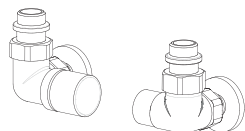

KIT VALVOLE CYL termostattabile con comando  
LATERALE, pag.273 Art. KCL 150,50€  
Colore tabella BREM supplemento 49,50€

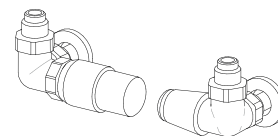

KIT VALVOLE TON comando LATERALE con testa  
TERMOSTATICA, pag. 269 Art. KTL 188,60€

# RAW

## MODELLI ORIZZONTALI

PREZZI DAL 01.03.2026 +5%

RAW con il suo design estremamente iconico con una forma senza forma, tridimensionale e vuota, è realizzato anche in versione orizzontale. I tubi tondi  $\varnothing$  25 mm saldati a

formare dei box ed uniti uno accanto all'altro creano forme affascinanti per l'uso in bagno.

design Davide Diliberto

### DIMENSIONI:

Larghezze da 77/104/130/157 cm

Altezze 50/77/104 cm

Profondità 10 cm

Sporgenza dal muro 13,5 cm



A' DESIGN AWARD  
WINNER 2019  
GOLD

### RAW1



RAW1 50-77



RAW1 50-104

### RAW2



RAW2 50-104



RAW2 50-130



RAW2 50-157A



RAW2 50-157B



RAW2 77-104



RAW2 104-77

### RAW3



RAW3 50-157

MODELLI ORIZZONTALI	HL cm	Bianco di serie sablé SB9016 €	EN 442			▲ ▼ int.att. cm	Altezza H cm		Larghezza L cm	Peso M Kg	Volume V dm <sup>3</sup>	VERSIONI MISTE con Resistenza e manicotto	
			Δt 50 K watt	Δt 40 K watt	Δt 30 K watt		Watt	€					
RAW1	50-77	653,00	356	272	192	68,5	50,5	77,0	5,5	2,7	400	117,20	
RAW1	50-104	728,40	421	320	224	95	50,5	103,5	6,7	3,3	400	117,20	
RAW2	50-104	941,90	578	440	308	95	50,5	103,5	8,8	4,3	650	121,30	
RAW2	50-130	998,30	647	492	345	121,5	50,5	130,0	9,9	4,9	650	121,30	
RAW2	50-157A	1054,80	712	539	376	148	50,5	156,5	11,1	5,5	650	121,30	
RAW2	50-157B	1054,80	717	543	379	148	50,5	156,5	11,1	5,4	650	121,30	
RAW2	77-104	1054,80	717	543	379	95	77,0	103,5	11,1	5,4	650	121,30	
RAW2	104-77	1054,80	726	548	384	68,5	103,5	77,0	11,1	5,4	800	125,70	
RAW3	50-157	1318,60	868	657	458	148	50,5	156,5	13,2	6,4	900	129,00	

\*Resistenza orizzontale

Termostati p.228-229

VERSIONI MISTE  
attacco EG ▲ ▼ 5 cm

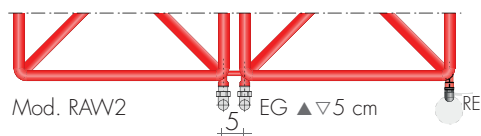
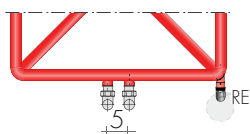

### ESECUZIONI DI SERIE

Colore bianco sablé SB9016, fissaggi B35  
Tolleranze  $\pm$  3mm - Valvola di sfianto  $\varnothing$  1/8"  
PRESSIONE MASSIMA D'ESERCIZIO 8 BAR

### ESECUZIONI A RICHIESTA

Verniciatura tabella colori Brem con mensole  
B35 colorate +15/25%  
Versione elettrica, e.Raw pag. 254

### ATTACCHI DI SERIE EG $\varnothing$ 1/2"

A richiesta attacchi  $\varnothing$  3/8"  
Piedini e divisori a richiesta  
Attacchi speciali, pag. 279

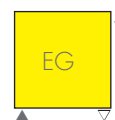

INTERASSE ATTACCHI

Attacchi serie EG verticali  
A richiesta attacchi laterali senza supplemento

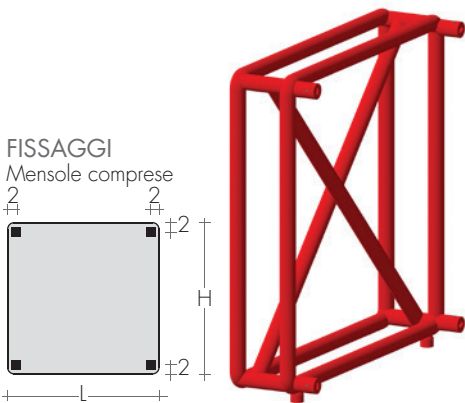
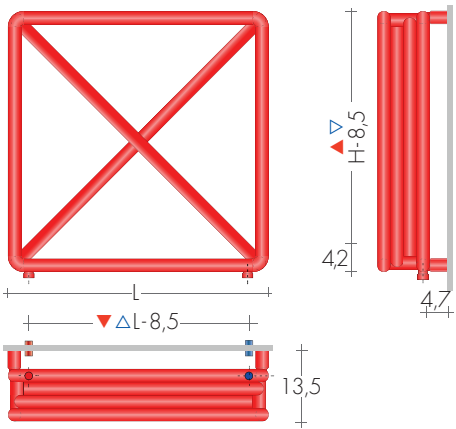

RAW2 104 77

VALVOLE CONSIGLIATE

- KIT VALVOLE CROMATE comprende:
- n°2 Valvole con codoli
  - n°2 Raccordi (per multistrato ø16 e rame ø12 e 14)
  - n°2 Rosette tonde cromo ø 48, foro ø16

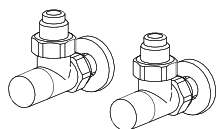

KIT VALVOLE MINI A SQUADRA pag.270  
cromo o colore bianco Art. KMS 114,80€

FINITURE SPECIALI pag. 267  
Finiture Oro, Bronzo, Nickel spazzolato per 2 valvole  
KIT Raccordi NICKEL spazz. suppl.Art. RN 28,20€

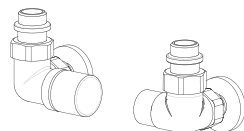

KIT VALVOLE CYL termostattabile con comando  
LATERALE, pag.273 Art. KCL 150,50€  
Colore tabella BREM supplemento 49,50€

ATTACCHI REMOTI Art. REM 37,60€  
Interasse attacchi sul retro: ▲▼ EG  
Valvole REMOTE pag. 274

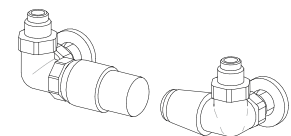
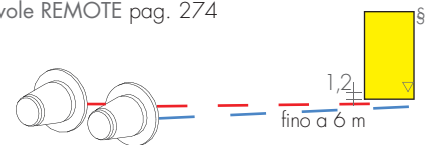

KIT VALVOLE TON comando LATERALE con testa  
TERMOSTATICA, pag. 269 Art. KTL 188,60€

Shar riassume tutte le caratteristiche dello scaldasalviette tradizionale.

I collettori di forma semiovale e i tubi radianti con diametro di 15mm, si fondono ed

esaltano l'armonia dell'assieme per un grande classico equilibrio.

#### DIMENSIONI

Larghezze: 33 / 45 / 50 / 60 / 75 cm

Altezze: 71,8 / 110,3 / 140,6 / 181,8 cm

Profondità: 3 cm

Sporgenza dal muro: 10,5 cm

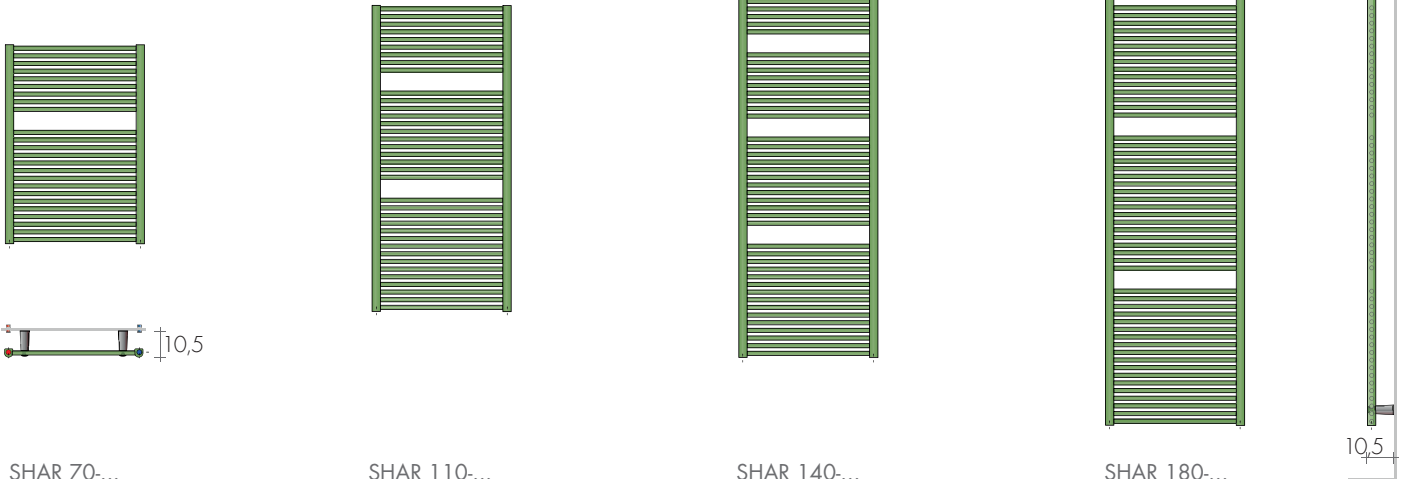

#### MODELLO

MODELLO	HL cm	Bianco di serie sablé SB 9016 €	EN 442			▲ ▽ int.att. cm	Altezza H cm	larghezza L cm	Peso M Kg	Volume V dm3	VERSIONI MISTE con Resistenza e* Watt €	
			Δt 50K watt	Δt 40K watt	Δt 30K watt						Watt	€
SHAR	70-45	357,10	353	267	181	42	71,8	45	4,9	3,12	400	95,70
SHAR	70-50	366,90	389	294	200	47	71,8	50	5,3	3,27	400	95,70
SHAR	70-60	381,30	458	346	235	57	71,8	60	6,1	3,59	500	97,80
SHAR	110-45	464,00	526	397	270	42	110,3	45	7,4	4,74	500	97,80
SHAR	110-50	475,80	580	438	298	47	110,3	50	8,0	4,97	650	99,80
SHAR	110-60	496,90	684	516	352	57	110,3	60	9,2	5,45	650	99,80
Slim SHAR	140-33	546,40	468	353	241	30	140,6	33	7,3	4,51	500	97,80
SHAR	140-45	583,50	653	493	336	42	140,6	45	9,3	6,00	650	99,80
SHAR	140-50	599,40	720	544	370	47	140,6	50	10,0	6,29	800	104,20
SHAR	140-60	624,90	851	643	437	57	140,6	60	11,6	6,88	900	107,50
Slim SHAR	180-33	667,90	618	467	318	30	181,8	33	9,7	4,89	650	99,80
SHAR	180-45	713,20	870	657	447	42	181,8	45	12,2	7,85	900	107,50
SHAR	180-50	732,80	955	721	491	47	181,8	50	13,2	8,24	900	107,50
SHAR	180-60	764,80	1126	850	579	57	181,8	60	15,3	9,03	1200	115,20
SHAR	180-75	815,10	1363	1029	701	72	181,8	75	18,1	10,21	1500	125,40
VERSIONE - CROMATA												
S-CROM	70-50	840,40	311	235	160	47	71,8	50	5,3	3,27	300	94,60
S-CROM	110-50	1090,00	464	350	238	47	110,3	50	8,0	4,97	500	97,80
S-CROM	110-60	1164,20	547	413	281	57	110,3	60	9,2	5,45	500	97,80
S-CROM	140-33	1250,30	374	282	193	30	140,6	33	7,3	4,51	400	95,70
S-CROM	140-50	1373,90	576	435	296	47	140,6	50	10,0	6,29	650	99,80
S-CROM	180-33	1531,40	494	373	254	30	181,8	33	9,7	4,89	500	97,80
S-CROM	180-45	1639,60	696	526	358	42	181,8	45	12,2	7,85	650	99,80
S-CROM	180-50	1677,70	764	577	393	47	181,8	50	13,2	8,24	800	104,20

A richiesta dimensioni su misura

▶ Pronta consegna solo bianco di serie

\*Aggiungere: Valvola mista o TR p.207  
Termostati p.208-209

#### PRESSIONE MASSIMA DI ESERCIZIO 8 BAR

#### ESECUZIONI DI SERIE

Colore bianco sablé SB9016, fissaggi M8B  
Finitura cromata con fissaggi cromati M8C  
Tolleranze ± 3mm - Valvola di sfianto ø 1/8"

#### ESECUZIONI A RICHIESTA

Verniciatura tabella colori Brem con fissaggi  
cromati M8C +15/25%  
Versione elettrica e.Shar, pag.257

#### ATTACCHI DI SERIE

EG ø 1/2"  
Attacchi speciali pag.279  
Shar DIVISORIO, pag.202



INTERASSE ATTACCHI

Attacchi di serie EG verticali

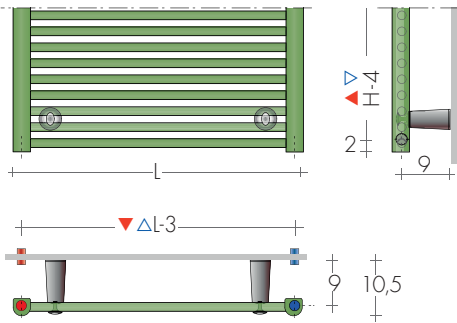

A richiesta attacchi laterali ▲▼ H-4 cm ø1/2" Supplemento Art. AS 81,40€

A richiesta mensole B70 verniciate nel colore dello scaldasalviette a=1,5cm con profondità 10cm Supplemento 2 mensole Art. MV2 30,00€ Supplemento 4 mensole Art. MV4 50,00€

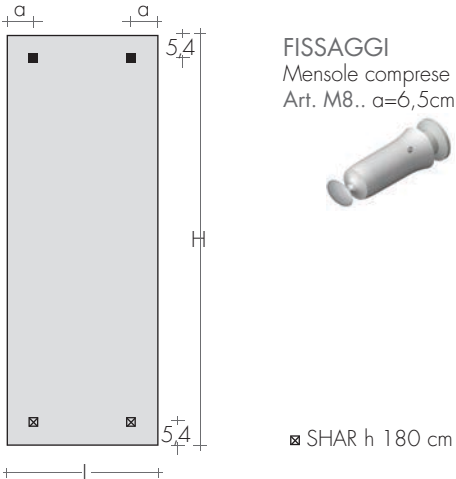

S-CROM 140-50

VALVOLE CONSIGLIATE

KIT VALVOLE CROMATE comprende:

- n°2 Valvole con codoli
- n°2 Raccordi (per multistrato ø16 e rame ø12 e 14)
- n°2 Rosette tonde cromo ø 48, foro ø16

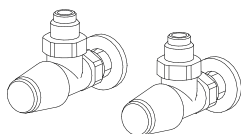

KIT VALVOLE TON A SQUADRA pag.269 Art. KVS 127,00€

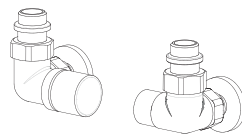

KIT VALVOLE CYL termostattabile con comando LATERALE, pag.273 Art. KCL 150,50€ Colore tabella BREM supplemento 49,50€

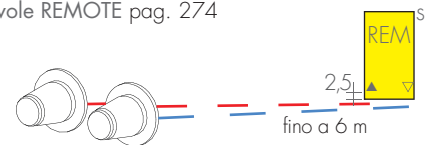

ATTACCHI REMOTI Art. REM 37,60€

Interasse attacchi sul retro: ▲▼ EG

Valvole REMOTE pag. 274

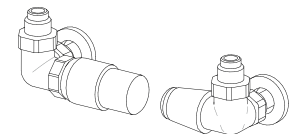

KIT VALVOLE TON comando LATERALE con testa TERMOSTATICA, pag. 269 Art. KTL 188,60€

SHAR-AIR è lo scaldasalviette tradizionale adatto per essere installato in ogni ambiente.

I collettori di forma semiovale e i tubi radianti con diametro di 15mm si ripetono con ritmi

diversi, formando un equilibrio armonioso e un'ampia gamma di rese termiche.

## DIMENSIONI

Larghezze: 50 / 60 cm

Altezze: 94,5/105,5/122/124,5/144,5/162/182/183,5/184,5 cm

Profondità: 3 cm

Sporgenza dal muro: 10 cm



SHAR-AIR  
95-50



SHAR-AIR  
125-50



SHAR-AIR  
162-50



SHAR-AIR  
184-..

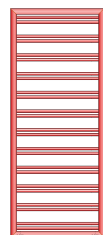
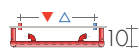

SHAR-A2R  
122-50

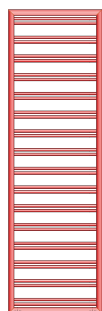

SHAR-A2R  
162-50



SHAR-A2R  
182-..

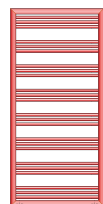
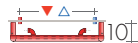

SHAR-A3R  
105-50

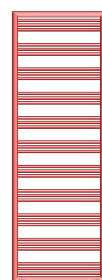

SHAR-A3R  
145-50



SHAR-A3R  
183-..

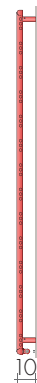

## MODELLO

MODELLO	HL cm	Bianco di serie sablé SB 9016 €	EN 442			▲ ▽ int.att. cm	Altezza H cm	larghezza L cm	Peso M Kg	Volume V dm <sup>3</sup>	VERSIONI MISTE con Resistenza e manico Watt €	
			Δt 50 K watt	Δt 40 K watt	Δt 30 K watt						Watt	€
SHAR-AIR	95-50	479,20	301	225	155	38	94,5	50	5	2,4	300	116,10
SHAR-AIR	125-50	522,60	387	289	199	38	124,5	50	6,3	3	400	117,20
SHAR-AIR	162-50	611,50	493	369	253	38	162	50	7,9	3,8	500	119,30
SHAR-AIR	184-50	645,10	558	417	287	38	184,5	50	8,9	4,3	500	119,30
SHAR AIR	184-60	670,10	636	476	327	48	184,5	60	9,9	4,7	650	121,30
SHAR-A2R	122-50	594,00	498	373	256	38	122	50	7,6	3,5	500	119,30
SHAR-A2R	162-50	711,30	647	484	333	38	162	50	9,7	4,5	650	121,30
SHAR-A2R	182-50	761,70	721	539	371	38	182	50	10,8	5	800	125,70
SHAR-A2R	182-60	808,70	837	626	430	48	182	60	12,3	5,6	900	129,00
SHAR-A3R	105-50	571,30	479	358	246	38	105,5	50	7,2	3,3	500	119,30
SHAR-A3R	145-50	702,50	639	478	328	38	144,5	50	9,5	4,3	650	121,30
SHAR-A3R	183-50	844,10	799	598	411	38	183,5	50	11,7	5,4	800	125,70
SHAR-A3R	183-60	900,50	932	697	479	48	183,5	60	13,4	6,1	900	129,00

Termostati p.228-229

## ESECUZIONI DI SERIE

Colore bianco sablé SB9016, fissaggi B70  
Tolleranze ± 3mm - Valvola di sfianto ø 1/8"  
PRESSIONE MASSIMA DI ESERCIZIO 8 BAR

## ESECUZIONI A RICHIESTA

Verniciatura tabella colori Brem con mensola  
B70 colorate +15/25%  
Versione elettrica e.Shar-AIR pag.258

## ATTACCHI DI SERIE

REG ø 1/2"  
Piedini e divisori, pag. 202  
Attacchi speciali pag.279



### INTERASSE ATTACCHI

Attacchi di serie REG con valvole reverse SHAR-AIR

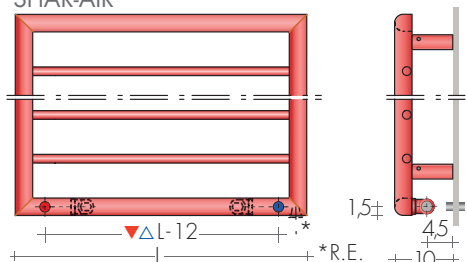

SHAR-A2R

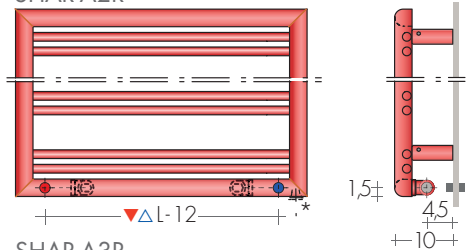

SHAR-A3R

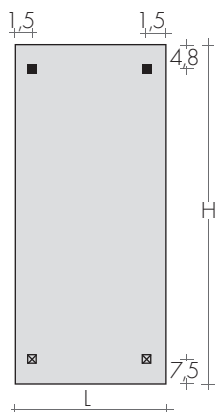
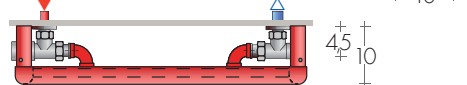
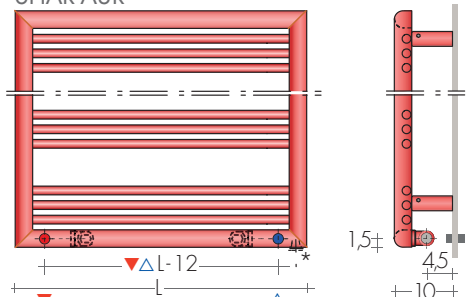

FISSAGGI  
Mensole B70 comprese



SHAR-AIR 162-50

SHAR-A2R 162-50

SHAR-A3R 183-50

### VALVOLE CONSIGLIATE

KIT VALVOLE CROMATE comprende:

- n°2 Valvole con codoli
- n°2 Raccordi (per multistrato ø16 e rame ø12 e 14)
- n°2 Rosette tonde cromo ø 48, foro ø16

### FINITURE SPECIALI

pag. 267  
Finiture Oro, Bronzo, Nickel spazzolato per 2 valvole  
KIT Raccordi NICKEL spazz. suppl. Art. RN 28,20€

### ATTACCHI REMOTI

Art. REM 37,60€  
Interasse attacchi sul retro: ▲▽ L - 16 cm  
Valvole REMOTE pag. 274

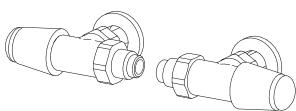
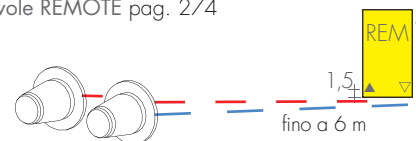

KIT VALVOLE TON REVERSE  
p.269 Art. KVR 127,00€

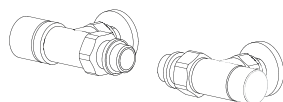

KIT VALVOLA CYL termostattabile REVERSA  
pag.273 Art. KCR 138,80€  
Colore tabella BREM supplemento 49,50€

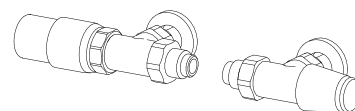

KIT VALVOLE TON REVERSE con TESTA TERMO-  
STATICA, pag. 269 Art. KTR 176,20€

# START START CURVO

PREZZI DAL 01.03.2026 +5%

Lo scaldasalviette START è costruito con tubi radianti sottilissimi  $\varnothing 12$  collegati a collettori verticali dalla esclusiva forma a ogiva.

La versione a tubi dritti ha la particolarità di avere sfalsati i tubi superiori dei ritmi per migliorare la distribuzione del calore.

START CURVO è stato il primo scaldasalviette prodotto con la superficie leggermente curva per avere i collettori più aderenti alla parete.

## DIMENSIONI

Larghezze: 35 / 45 / 55 / 60 cm

Altezze: 75 / 90 / 120 / 150 / 180 cm

Profondità: 4,7 cm

Sporgenza dal muro: 10 cm

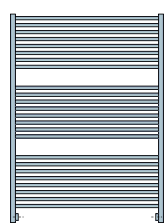

START 75 - ...

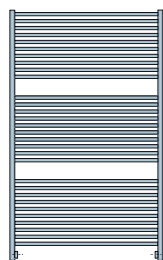

START 90 - ...  
ST-CURVO 90-55

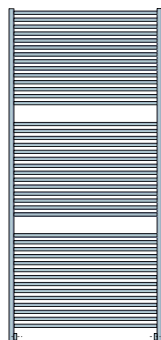

START 120 - ...  
ST-CURVO 120-55

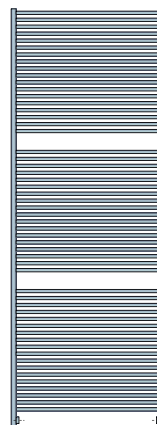

START 150 - ...  
ST-CURVO 150-55



START 180 - ...

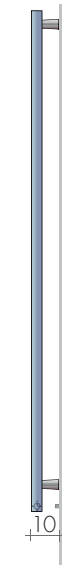

MODELLO	H-L cm	Bianco di serie sablé SB 9016 €	EN 442			▲ ▼ int.att. cm	Altezza H cm	Larghezza L cm	Peso M Kg	Volume V dm <sup>3</sup>	VERSIONI MISTE con Resistenza e manicotto	
			Δt 50K watt	Δt 40K watt	Δt 30K watt						Watt	€
START	75-45	373,70	339	256	174	31	75	45	4,4	1,46	300	116,10
START	75-55	391,30	401	303	206	41	75	55	5,0	1,65	400	117,20
START	90-45	457,00	409	309	210	31	90	45	5,4	1,79	400	117,20
START	90-55	476,40	484	365	249	41	90	55	6,2	2,03	500	119,30
START	120-45	546,40	552	417	284	31	120	45	7,4	2,46	500	119,30
START	120-55	566,10	654	494	336	41	120	55	8,6	2,79	650	121,30
Slim START	150-35	663,20	573	433	295	21	150	35	7,1	2,43	650	121,30
START	150-45	682,50	703	531	361	31	150	45	9,4	3,12	650	121,30
START	150-55	711,70	832	628	428	41	150	55	10,9	3,54	800	125,70
START	180-45	782,60	861	650	443	31	180	45	11,5	3,78	900	129,00
START	180-55	811,70	1016	767	522	41	180	55	13,3	4,30	900	129,00
START	180-60	831,50	1094	826	562	46	180	60	14,2	4,56	1200	136,70
VERSIONE - CROMO												
ST-CROM	90-45	1017,70	327	247	168	31	90	45	5,4	1,79	300	116,10
ST-CROM	90-55	1061,60	386	291	199	41	90	55	6,2	2,03	400	117,20
ST-CROM	120-45	1215,80	442	334	227	31	120	45	7,4	2,46	400	117,20
ST-CROM	120-55	1259,70	523	395	269	41	120	55	8,6	2,79	500	119,30
ST-CROM	150-45	1519,60	562	424	289	31	150	45	9,4	3,12	500	119,30
ST-CROM	150-55	1585,80	666	503	343	41	150	55	10,9	3,54	650	121,30
ST-CROM	180-35	1698,80	565	427	291	21	180	35	9,6	2,94	500	119,30
ST-CROM	180-55	1808,30	813	614	418	41	180	55	13,3	4,30	800	125,70
START CURVO												
ST-CURVO	90-55	654,30	484	365	249	39,5	90	54	6,2	2,03	500	119,30
ST-CURVO	120-55	760,10	654	494	336	39,5	120	54	8,6	2,79	650	121,30
ST-CURVO	150-55	927,40	832	628	428	39,5	150	54	10,9	3,54	900	129,00
START CURVO CROMO												
C-CROM	120-55	1588,00	523	395	269	39,5	120	54	8,6	2,79	500	119,30
C-CROM	150-55	1937,10	666	503	343	39,5	150	54	10,9	3,54	650	121,30

A richiesta dimensioni su misura

Pronta consegna solo bianco di serie

Termostati p.228-229

## ESECUZIONI DI SERIE

Colore bianco sablé SB9016, fissaggi bianchi  
Valvola di sfiato  $\varnothing 1/8''$  - Tolleranze  $\pm 3$ mm  
Pressione massima di esercizio 8 bar

## ESECUZIONI A RICHIESTA

Verniciatura tabella colori Brem con fissaggi cromati  
+15/25%  
Versione elettrica e.Start, pag.259

## ATTACCHI DI SERIE

REG  $\varnothing 1/2''$   
Attacchi su richiesta EG e laterali  
Start Divisorio, pag. 202



INTERASSE ATTACCHI REG

Modello START, di serie attacchi REG

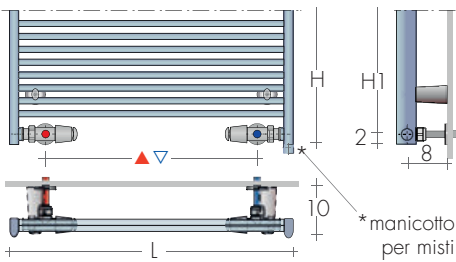

Modello START CURVO, di serie attacchi REG

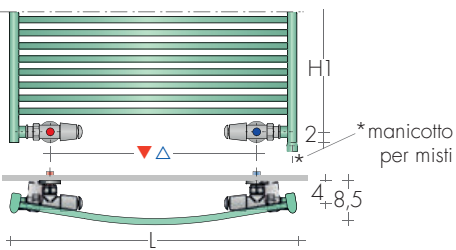

L'altezza (H1) viene ridotta di 4 cm per:

- ATTACCHI EG (i.a.L-1,8cm)
- ATTACCHI LATERALI AC/BD (H1-4cm)

A richiesta Supplemento Art. AS 81,40€

A richiesta mensole B55 verniciate nel colore dello scaldasalviette a=0,9cm con profondità 9,3cm

Supplemento 2 mensole Art. MV2 30,00€

Supplemento 4 mensole Art. MV4 50,00€

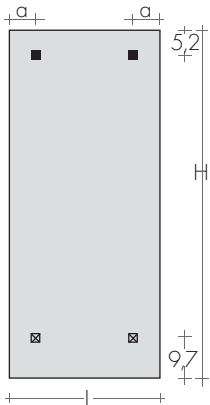

FISSAGGI START  
Mensole comprese  
Art. M8.. a=5 cm



Start CURVO



Art. M4F.. a=5 cm

☒ H 180 cm



START 180-45

VALVOLE CONSIGLIATE

KIT VALVOLE CROMATE comprende:

- n°2 Valvole con codoli
- n°2 Raccordi (per multistrato ø16 e rame ø12 e 14)
- n°2 Rosette tonde cromo ø 48, foro ø16

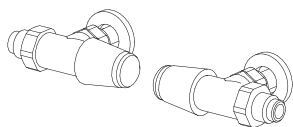

KIT VALVOLE TON REVERSE  
p.269 Art. KVR 127,00€

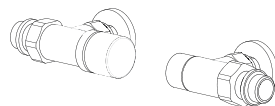

KIT VALVOLA CYL termostattabile REVERSA  
pag.273 Art. KCR 138,80€  
Colore tabella BREM supplemento 49,50€

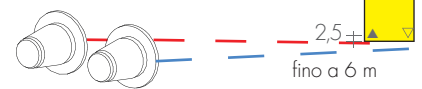

ATTACCHI REMOTI Art. REM 37,60€

Interasse attacchi sul retro: ▲▼ EG

Valvole REMOTE pag. 274

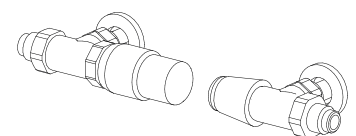

KIT VALVOLE TON REVERSE con TESTA TERMO-STATICA, pag. 269 Art. KTR 176,20€

# SHAR DIVIS START DIVIS KUAD DIVIS

SCALDASALVIETTE DIVISORI

PREZZI DAL 01.03.2026 +5%

Gli scaldasalviette SHAR, START e KUAD con l'aggiunta di piedini e fissaggi o

a soffitto, possono essere inseriti come divisori nei bagni, in cucina o nei locali in

cui si vuol ricercare estetica e funzionalità.

## ATTACCHI REVERSI

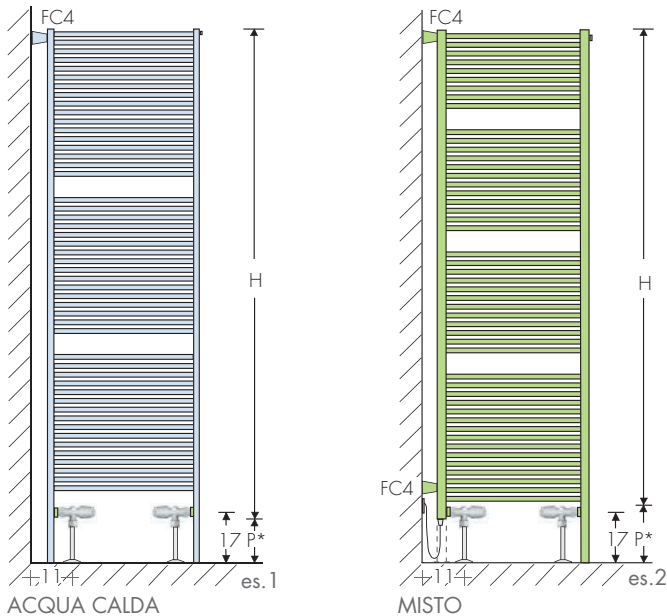

ACQUA CALDA

MISTO

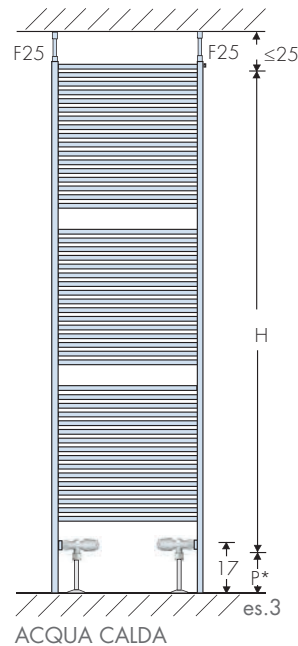

ACQUA CALDA

## ATTACCHI VERTICALI

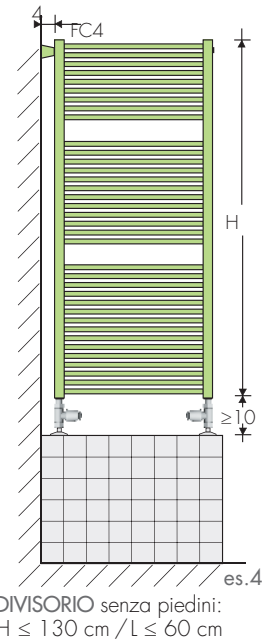

DIVISORIO senza piedini:  
H ≤ 130 cm / L ≤ 60 cm

## SCALDASALVIETTE DIVISORI

SHAR DIVIS H di serie +19 cm (P\*)

START/KUAD DIVIS H di serie +15 cm (P\*)

PIEDINO COLLETTORE (P\*)

Piedino Shar (cad.) Art. PC19 89,40€

Piedino Start/Kuad (cad.) Art. PC15 89,40€

COPRIPIEDINO (cad.) Art. PT 32,70€

FISSAGGIO VERNICIATO LATERALE

riducibile da 10 a 4 cm Art. F10 74,90€

FISSAGGIO VERNICIATO A SOFFITTO

riducibile da 25 a 4 cm Art. F25 78,10€

FISSAGGIO CROMATO (con manicotto 1/8")  
regolabile 4/6 cm Art. FC4 64,10€

ATTACCHI reversi o laterali ø 1/2" per  
scaldasalviette divisori Art. AS 81,40€

Interasse attacchi laterali Shar: H-4 cm

Interasse attacchi laterali Start/Kuad: H-4-4cm

Interasse attacchi reversi Shar: L-17,7 cm

Interasse attacchi reversi Start/Kuad: L-14 cm

MANICOTTO ø 1/2" o ø 3/8" per  
l'applicazione della resistenza pag. 207

Art. M12 21,50€

Art. M38 21,50€

"Inoltre sempre disegno quotato"

## ATTACCHI LATERALI

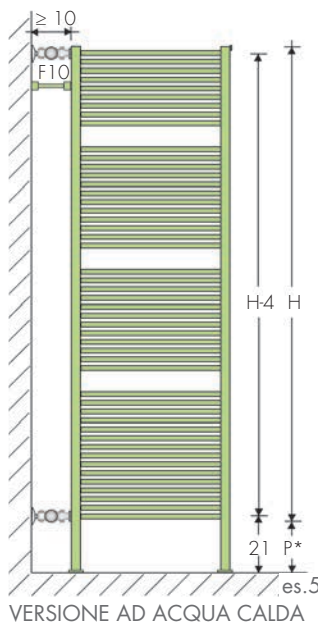

VERSIONE AD ACQUA CALDA

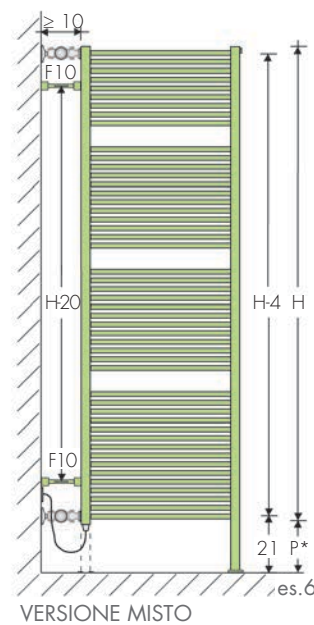

VERSIONE MISTO

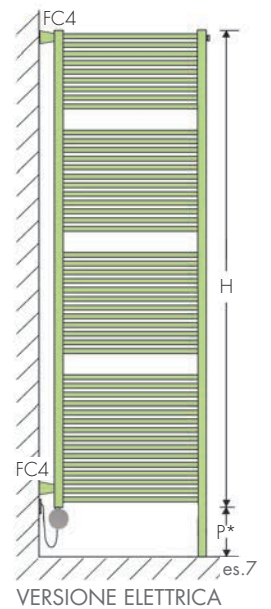

VERSIONE ELETTRICA

SCALDASALVIETTE DIVISORI CROMATI  
Richiedere fattibilità e preventivo.

CROSS DIVISORIO pag. 58

## ESECUZIONI DI SERIE

Colore bianco sablé SB9016,

Valvola di sfiato ø 1/8" - Tolleranze ± 3mm

PRESSIONE MASSIMA DI ESERCIZIO 8 BAR

202

## ESECUZIONI A RICHIESTA

Verniciatura tabella colori Brem con  
i relativi fissaggi

+15/25%

## ATTACCHI DI SERIE

REG (BD/AC) ø 1/2"

EG ø 1/2"

A richiesta: versioni elettriche

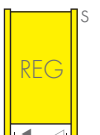

### MODELLO SHAR

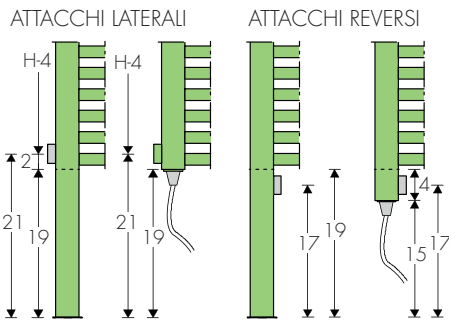

### MODELLO START/KUAD

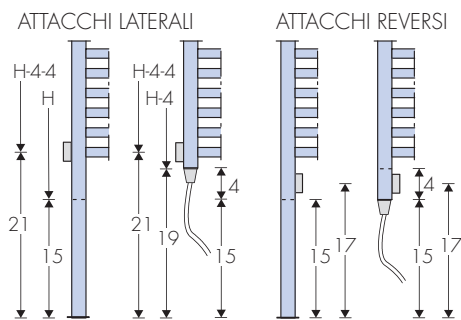

Il prezzo dello scaldasalviette divisorio si ottiene aggiungendo al modello bianco di serie:

- piedini, fissaggi e attacchi,
- accessori, valvole, copritubi e rosette.

**Es.1: START DIVIS (ad acqua)** 180-55 (H+15cm)

START 180-55 bianco	n°1	811,70€
Art. PC15 piedino h=15	n°2	178,80€
Art. FC4	n°1	64,10€
Supplemento attacchi Art. AS	n°1	81,40€
<b>Tot.</b>		<b>1135,50€</b>

**Es.2: SHAR DIVIS (versione mista)** 180-50 (H+19cm)

SHAR 180-50 bianco	n°1	732,80€
Art. PC19 piedino h=19 cm	n°1	89,40€
Art. FC4	n°2	149,80€
Art. M38 per R.E.	n°1	21,50€
Art. R900II per R.E. 900W	n°1	107,50€
Supplemento attacchi Art. AS	n°1	81,40€
<b>Tot.</b>		<b>1182,40€</b>

**Es.3: e.KUAD DIVIS (elettrico)** 175-50 (H+15cm)

e.KUAD 175-50 bianco	n°1	794,30€
Art. PC15 piedino h=15 cm	n°1	89,20€
Art. FC4	n°2	128,20€
KIT RT 900IIT	n°1	236,30€
Termostato bianco	Art. DYPB	83,00€
<b>Tot.</b>		<b>1331,00€</b>



START DIVIS 180-55

### VALVOLE CONSIGLIATE

KIT VALVOLE CROMATE comprende:

- n°2 Valvole con codoli
- n°2 Raccordi (per multistrato ø16 e rame ø12 e 14)
- n°2 Rosette tonde cromo ø 48, foro ø16

### FINITURE SPECIALI

pag. 267  
 Finiture Oro, Bronzo, Nickel spazzolato per 2 valvole  
 KIT Raccordi NICKEL spazz. suppl.Art. RN 28,20€

### VALVOLE PER ATTACCHI LATERALI

KIT VALVOLE TON DIRITTA  
 p. 269 Art. KVD 138,20€

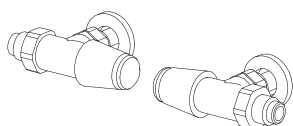
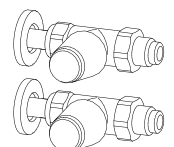

KIT VALVOLE TON REVERSE  
 p.269 Art. KVR 127,00€

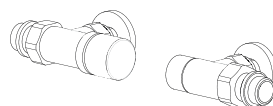

KIT VALVOLA CYL termostattabile REVERSA  
 pag.273 Art. KCR 138,80€  
 Colore tabella BREM supplemento 49,50€

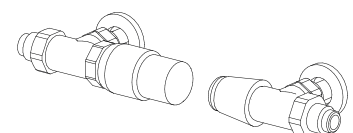

KIT VALVOLE TON REVERSE con TESTA TERMO-  
 STATICA, pag. 269 Art. KTR 176,20€



# ELECTRIC INDEX

- A GREEN CHOICE
- INDEPENDENCE FROM THE CENTRAL HEATING SYSTEM
- FOR EXTRA HEAT AT LOW TEMPERATURES
- SMART DOMOTIC DIALOGUE
- ENERGY-SAVING PTC ELECTRICAL HEATING ELEMENTS AND A SPECIAL ADJUSTABLE FITTING ON THE REAR

## RADIATORS COLLECTION

	page
e.CHEM	214
e.CLAK	216
e.CROSS-G	220
e.CROSS-Q	221
e.CROSS-V	220
e.LAME	230
e.LAME-UP	231
e.HERG	235
e.PHUL	247
e.REGULAR	255

*BREM offers a wide range of radiators and electric towel warmers representing nearly all products presented by Brem.*

## TOWEL HEATER COLLECTION

	page
e.ALIS	210
e.ASYMM e.ASYMP	211
e.CAMEO	212
e.CANNUCCIA STRAW	213
e.CHEM-M e.CHEM-S	214
e.CLARK	217
e.CROSS	218
e.CROSS-CROM ..-FO/FA	219
e.CROSS-Q	221
e.CROSS-R	222
e.CUBICO	223
e.DUO	224
e.ESSEN	225
e.FIT	226
e.FLAG	227
e.FRAC	228
e.FREE	229
e.GEOMETRICA-T ..-O	230
e.GEOMETRICA-Q ..-R	231
e.GUEST	232
e.HAND	233
e.HERG-OT	234
e.HERG'S	235
e.HOOK	236
e.KORE PLUS	237
e.KUAD	238
e.KUO	239
e.LAMATH	240
e.LAME SLIM	242
e.MAHN	244
e.MAHN-AIR	245
e.MANT	246
e.PIT	248
e.PLANK e.PLANK-AIR	249
e.PLATT	250
e.PLUS 12	251
e.PLUS18 e.PLUS-AIR	252
e.QUAR	253
e.RAW	254
e.SBARRA e.SBARRA-UP	256
e.SHAR	257
e.SHAR-AIR	258
e.START	259
e.UNIPLATT	260
e.VELETTA	261
e.VISION	262
e.ZOOM	263

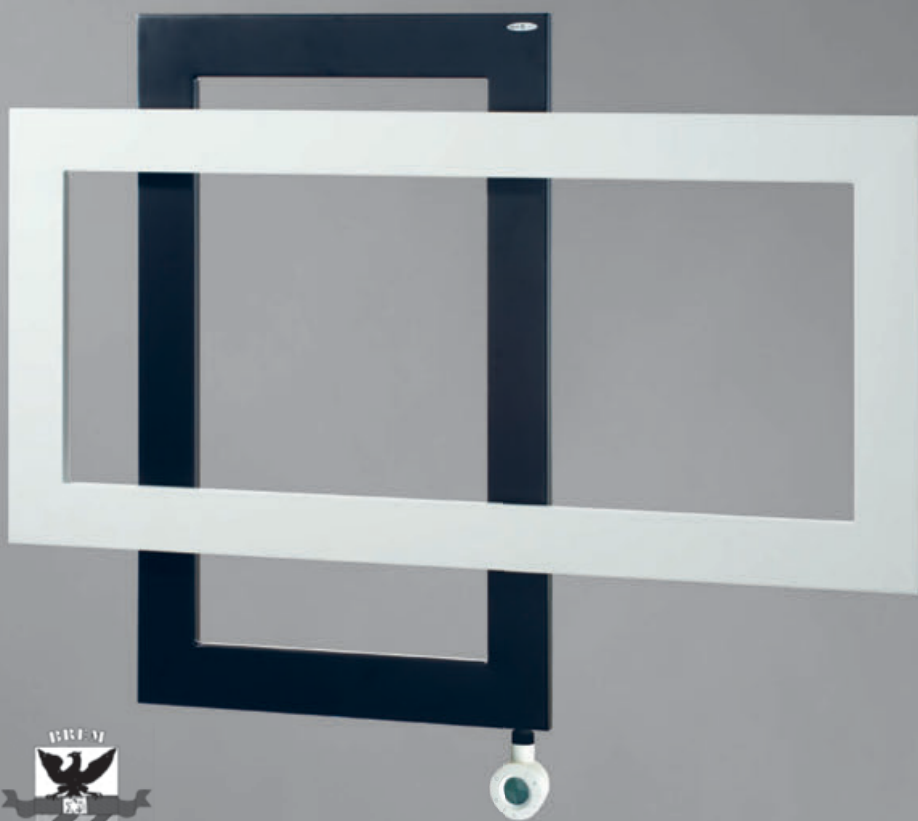

# ELECTRIC HEATING ELEMENT

PRICE FROM 01.03.2026 **+5%**

BREM uses PTC electric heating element. PTC means "Positive Temperature Coefficient" and characterizes the electrical behaviour of the semiconductor heater segment: with increasing temperature the resistance of the PTC element rises instantaneously and reduces automatically the power output generating the so called "self-limiting" effect.

1200W and 1500W electric heating elements work using constant power and are equipped with thermal limiter that stops the emission of heat.

The class II PTC heating up process will automatically go through three phases:

- Start-up. In the first 60 sec the PTC works at 130% circa of the nominal power ("turbo boost power" effect) to trigger best the convection inside the radiator;
- Nominal power phase. In this phase the PTC heating elements reaches the equilibrium temperature working at the nominal power;
- Energy saving phase. With the increasing of the ambient temperature the power output decreases until a new equilibrium is reached where the power consumption is reduced (typically at 70% - 80% of the nominal power).

The PTC electric heating elements (CE marked) have the following advantages:

- Intrinsic safety (no risk of overheating, burnings or fire)
- No need of thermofuse and therefore no more burnt heaters also in case of partial filling
- Reduced diameter and length vs constant power heaters (in particular 11 mm diameter also for class II elements)
- No cold lengths (differently from constant power heaters which require not heating zones for the thermostat and the thermofuse)
- Better circulation and faster heat-up times
- Absolutely no noise due to cavitation effects
- Better duration thanks to the reduction of the PTC on/off phases.

**ELECTRIC RESISTANCE R...II WITH CABLE**, in stainless steel with special 3/8" connection and 1.5 m long cable to be connected to the electrical system. The terminal part can be rotated  $\pm 90^\circ$  to allow the electric cable to be directed directly towards the wall or to the side, where it connects better to the electrical socket (3/8" to 1/2" adapter included)

**ELECTRIC RESISTANCE R...IIF WITH FASTON** in stainless steel with 1/2" connection, without cable, is equipped with faston connectors for connecting the thermostat.



Art. R...II  
with cable for  
Wireless Thermostat



Art. R...IIF  
 $\varnothing 1/2$ , with Faston  
for Digital Thermostat

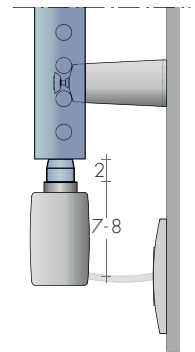
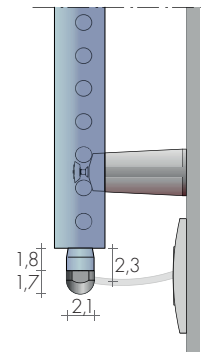

## E.H.E. CLASS II

power absorbed	average consumption	$\varnothing 3/8"$ with cable	$\varnothing 1/2"$ with faston	PRICE
R.E. 250W	~0,19 KWH	Art. R250II	Art. R250IIF	101,10€
R.E. 300W	~0,225 KWH	Art. R300II	Art. R300IIF	102,20€
R.E. 400W	~0,30 KWH	Art. R400II	Art. R400IIF	103,40€
R.E. 500W	~0,375 KWH	Art. R500II	Art. R500IIF	105,60€
R.E. 650W	~0,49 KWH	Art. R650II	Art. R650IIF	107,80€
R.E. 800W	~0,60 KWH	Art. R800II	Art. R800IIF	112,60€
R.E. 900W	~0,675 KWH	Art. R900II	Art. R900IIF	116,20€
R.E. *1200W	~0,90 KWH	Art. R1200II	Art. R1200IIF	124,50€
R.E. *1500W	~1,125 KWH	Art. R1500II	Art. R1500IIF	135,40€

\*Electric Heating Element working with constant power e.g. Average consumption 0,46/0,52 KWH (average 0,49KWH) per hour with 650W electric heater x cost of KWH in the bill



E.H.E. Cable Cover

Sleeve 3/8" Art. CCRE38 73,40€  
Sleeve 1/2" Art. CCRE12 73,40€

The EU 2015/1188 ECodesign standard provides that electric towel heaters and radiators, in order to save energy, work with devices equipped with weekly programming, electronic temperature control and open window detector.

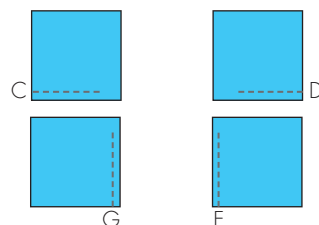

Electric Heating Element POSITION  
 C Horizontal E.H.E. (on request in D)  
 G Vertical E.H.E. (on request in E)  
 To verify for each model

## WARNINGS

TOWEL HEATERS WITH CLASS II ELECTRIC HEATING ELEMENT CAN BE INSTALLED INSIDE SPACE 2, WITH CABLE INSIDE SPACE 3



# MIXED TOWEL HEATERS & RADIATORS

PRICE FROM 01.03.2026 **+5%**

## ARTICLES FOR MIXED VERSIONS

By applying an electric resistance to the Brem towel warmers, they heat the rooms in the intermediate seasons when the centralized system is off (hydraulic and electric operation).

The application of the electric heating element is thanks to:

- $\varnothing$  3/8" special sleeve welded on the return tube
- or  $\varnothing$  1/2" sleeve for digital thermostat
- chrome plated TR accessory mounted on the return tube
- using the mixed valve for the connection

Art. M38	24,00€
Art. M12	24,00€
Art. TR	24,00€

## MIXED VERSIONS with SLEEVE

Put the  $\varnothing$  3/8" or  $\varnothing$  1/2" sleeve for the electric heating element on the return manifold

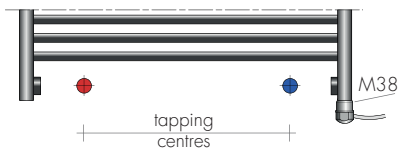

## MIXED VERSIONS with TR Accessory

The tapping centres are reduced by 8 cm

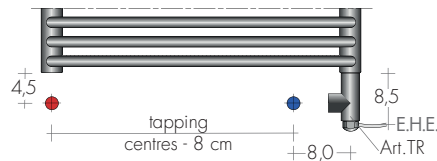

## MIXED VERSIONS WITH MIXED VALVES

BREM offers a side control valve, complete with a  $\varnothing$  1/2" fitting for the electrical heating element, to be installed on the right manifold of the return.

Using the mixed valve results in an increase in depth from the wall of 2cm.

## VALVES TON CHROME MIXED

TON side control, with fitting and round washer	Art.	multilayer	copper
		€	€
side control (S) delivery	LS..	65,90	63,60
TON side control MIXED (D)	LXD..	103,70	101,30
KIT TON MIXED	KLXD	188,20	

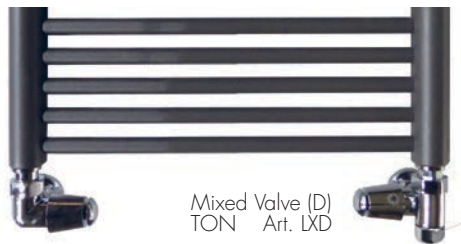

Mixed Valve (D)  
TON Art. LXD

## VALVE CYL CHROME MIXED LOCKSHIELD

CYL side control, with fitting and round washer	Art.	multilayer	copper
		€	€
side control (S) (delivery)	CLS..	85,30	82,90
CYL lockshield MIXED (D)	CYLXD	98,20	95,80
KIT CYL MIXED	KCLXD	202,10	

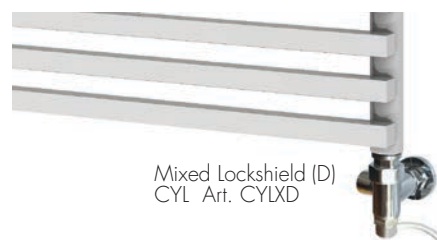

Mixed Lockshield (D)  
CYL Art. CYLXD

## VALVE QUADRA CHROME MIXED

QUADRA side control, with fitting and round washer	Art.	multilayer	copper
		€	€
side control (S) (delivery)	QLS..	86,40	84,00
QUADRA MIXED (D)	QLXD..	112,00	109,80
KIT QUADRA MIXTE	KQLX	220,30	



Mixed Valve (D)  
QUADRA Art. QLXD

THE RESISTANCE MUST WORK CONNECTED TO A THERMOSTAT  
compliant with ECODESIGN STANDARDS (pages 208-209)



LAME Mixed versions



UNI PLATT Mixed Quadra valve with thermostat



START Mixed version



UNI PLATT Mixed Quadra valve

# KIT RE and Wi-Fi THERMOSTATS

PRICE FROM 01.03.2026 + **5%**

## RE KIT ELECTRIC HEATING ELEMENT with CABLE

- RE KIT with:
- Class II Electric Heating Element  $\varnothing 1/2"$  with adjustable cable ( $\pm 90^\circ$ )
  - Filling with diathermic liquid and test
  - Chrome-plated plugs and brackets for wall fixing

KIT RE	d.II with Electric Heating Element	250W	Art.	R250IIE	191,90€
KIT RE	d.II with Electric Heating Element	300W	Art.	R300IIE	193,80€
KIT RE	d.II with Electric Heating Element	400W	Art.	R400IIE	195,70€
KIT RE	d.II with Electric Heating Element	500W	Art.	R500IIE	208,50€
KIT RE	d.II with Electric Heating Element	650W	Art.	R650IIE	222,90€
KIT RE	d.II with Electric Heating Element	800W	Art.	R800IIE	240,50€
KIT RE	d.II with Electric Heating Element	900W	Art.	R900IIE	255,30€
KIT RE*	d.II with Electric Heating Element	1200W	Art.	R1200IIE	276,30€
KIT RE*	d.II with Electric Heating Element	1500W	Art.	R1500IIE	298,00€

\*Electric heating element working with constant power



E.H.E. Cable Cover  
Sleeve 3/8" Art. CCRE38 73,40€  
Sleeve 1/2" Art. CCRE12 73,40€

THE HEATER MUST WORK CONNECTED TO A THERMOSTATIC CONTROL

## KIT RT-WIFI

TR-WIFI is a wifi system with a single-zone thermostat, gateway and receiver that allows you to turn on, turn off and program up to 6 electric towel warmers directly or via wifi with the free dedicated App.

The RTWIFI Kit includes:

- Thermostat (battery operated)
- Built-in receiver
- Gateway Art. KITRT-wifi 199,80€

Additional receiver for electric radiators and split AC: 1 for each electrical radiator (up to 6) Art. SA868 64,20€

## THERMOSTATS WiFi

compiants with ECODESIGN standards



FREE APP  
SALUS RT310i

### FEATURES

- Switching volt free and 230V
- Optional control via Smartphone, Tablet or PC
- Easy to use App
- Pre-paired wireless communication, so no more dip switches!
- Wall or desk mounted thermostat
- Choose to use schedule or control manually
- Adjustable frost protection when the thermostat is off
- Wireless communication test function
- Suitable for heating or cooling applications

## OPTIONAL

On wall box for receiver

Art. SUNI 19,90€ 8,4 x 8,4 x 2,8 cm



### RT-WIFI PROGRAMS

- Daily program for the entire week (every day is the same)
- Program for weekdays and weekends (5/2)
- Daily program (every day is different)
- Vacation Mode Program stops the system, to resume the set program.

5 Year Warranty

## KIT ELY-WIFI TOP DESIGN

KIT ELY-WIFI is a wifi system with a single-zone thermostat advanced area for heating and cooling systems that allows you to manage the climate of your home with ease and comfort; controls up to 16 electric radiators.

Art. KITELY-wifi 396,10€

KIT ELY TOP Design includes:

- Thermostat with magnetic charging base and magnetic plate for wall mounting
- Rechargeable Li-ion battery with wireless recharging.
- Gateway a 230V
- Receiver (Relay)



Additional receiver for electric radiators and (split AC): 1 for each electrical device (up to 16) Art. SA600 99,10€

### KIT ELY TOP DESIGN WIFI

Modern design with a metallic ring and negative display. WiFi setup via Bluetooth. Controls heating and cooling via app or locally. Energy optimisation features. Zigbee 2.4 GHz communication.

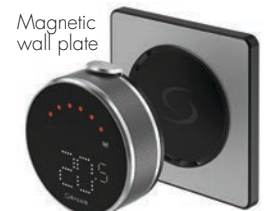

App: Salus Premium Lite

GOOGLE Assistance

COMPATIBLE with:



# KIT RT and THERMOSTATS ON THE RADIATOR

PRICE FROM 01.03.2026 **+5%**

## RT KIT ELECTRIC HEATING ELEMENT with FASTON

- RT KIT with:
- Class II Electric Heating Element (double protection)  $\varnothing 1/2"$  with Faston
  - Filling with diathermic liquid and test
  - Chrome-plated plugs and brackets for wall fixing

KIT RT	cl.II with Electric Heating Element	250W	Art.	R250IIT	191,90€
KIT RT	cl.II with Electric Heating Element	300W	Art.	R300IIT	193,80€
KIT RT	cl.II with Electric Heating Element	400W	Art.	R400IIT	195,70€
KIT RT	cl.II with Electric Heating Element	500W	Art.	R500IIT	208,50€
KIT RT	cl.II with Electric Heating Element	650W	Art.	R650IIT	222,90€
KIT RT	cl.II with Electric Heating Element	800W	Art.	R800IIT	240,50€
KIT RT	cl.II with Electric Heating Element	900W	Art.	R900IIT	255,30€
KIT RT*	cl.II with Electric Heating Element	1200W	Art.	R1200IIT	276,30€
KIT RT*	cl.II with Electric Heating Element	1500W	Art.	R1500IIT	298,00€

\*Electric heating element working with constant power

THE HEATER MUST WORK CONNECTED TO A THERMOSTATIC CONTROL

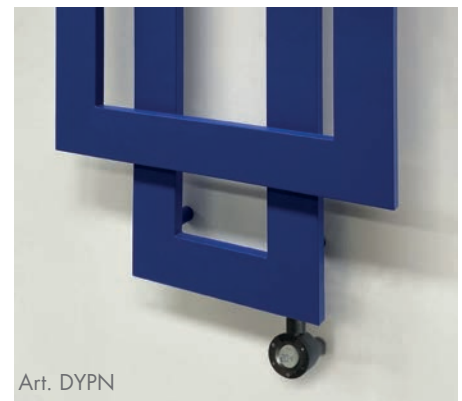

Art. DYPN

## THERMOSTATS on the RADIATOR

compiants with ECODESIGN standards

### THERMOSTAT DYP

DYNAMIC PRO is a white or black digital chronothermostat that can be positioned on the right or left of the towel warmer; 90 cm cable and with 2.5 cm adjustable cable cover.

\* possible sleeve for the E.H.E.  
(check the drawings of each model)

- White thermostat with white cable cover adjustable in depth

Art. DYPB 89,60€

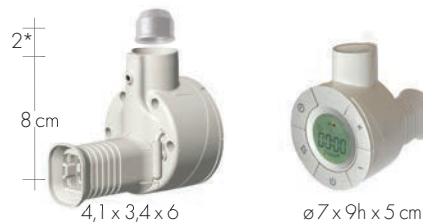

Art. DYPB

- Black thermostat, complete with black cable cover

Art. DYPN 103,40€



Art. DYPN

### REMOTE CONTROL for DYP Thermostats

10,8 x 5,3 x 2,3 cm

Infrared remote control with display and wall mounting support (magnetic coupling) is equipped with double transmitter and presence sensor

Art. TIR 41,00€



### CIRCLE Wi-Fi THERMOSTAT (up to 800w heating elements)

The innovative Wifi user interface allows the control of the towel warmers with a dedicated App from a device such as a tablet or a smartphone with both Android and iOS operating systems.  
80 cm cable length

- Chrome and glossy black finish Art. CIR-wifi 198,50€



Art. CIR chrome and glossy black

TECHNICAL DATA p. 52  
ELECTRIC KIT DATA p. 208-209



MODEL	H - L cm	Standard white sablé SB 9016 €	BREM Colors		KIT HEATING ELEMENT with:		
			+15% €	+25% €	Cable R...E Art. (W)	Faston R...T Art. (W)	€
ALIS-ONE	56-51	546,60	628,60	683,30	R300IIE	R300IIT	193,80
ALIS-ONE	56-91	640,00	736,00	800,00	R500IIE	R500IIT	208,50
ALIS-ONE	56-121	710,10	816,60	887,60	R650IIE	R650IIT	222,90
ALIS-ONE	70-51	586,00	673,90	732,50	R400IIE	R400IIT	195,70
ALIS-ONE	98-51	664,80	764,50	831,00	R500IIE	R500IIT	208,50
ALIS-ONE	126-51	743,70	855,30	929,60	R650IIE	R650IIT	222,90
ALIS-ONE	154-51	822,50	945,90	1028,10	R800IIE	R800IIT	240,50
ALIS-ONE	182-51	901,40	1036,60	1126,80	R900IIE	R900IIT	255,30

HEATING ELEMENT POSITION  
© Vertical Heating Element

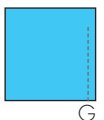

## THERMOSTATS Wi-Fi FOR KIT RE P. 208

## ACCESSORIES FOR

E.H.E. white cable cover  
or radiator color (together)  
Art.CCRE38 ø3/8" 73,40€  
Art.CCRE12 ø1/2" 73,40€



The KIT RT Wi-Fi includes:  
- Thermostat RT (battery)  
- Gateway  
- Built-in receiver

Art. KITRT-wifi 199,80€

Additional receiver  
(up to 6) radiators)

Art. SA868 64,20€



KIT ELY Wi-Fi TOP DESIGN includes:  
- Thermostat with magnetic charging base  
and magnetic plate for wall mounting  
- Gateway a 230V  
- Built-in Receiver

Art. KITELY-wifi 396,10€

Additional receiver: 1 for each electrical radiators  
or split AC (up to 16) Art. SA600 99,10€



design Luigi Brembilla

TECHNICAL DATA p. 54  
ELECTRIC KIT DATA p. 208-209

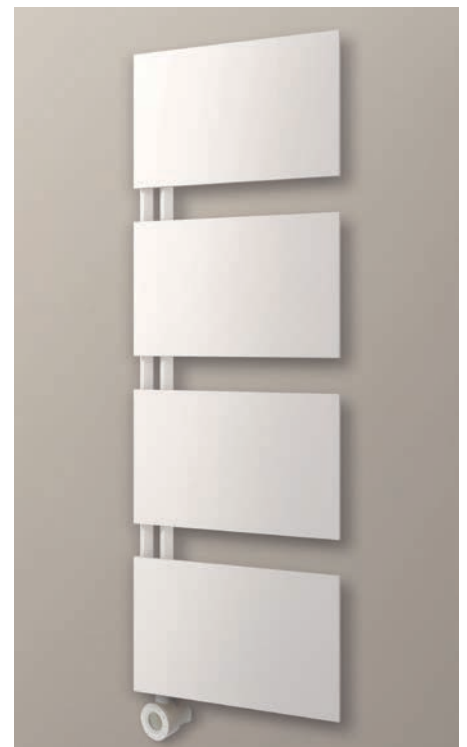
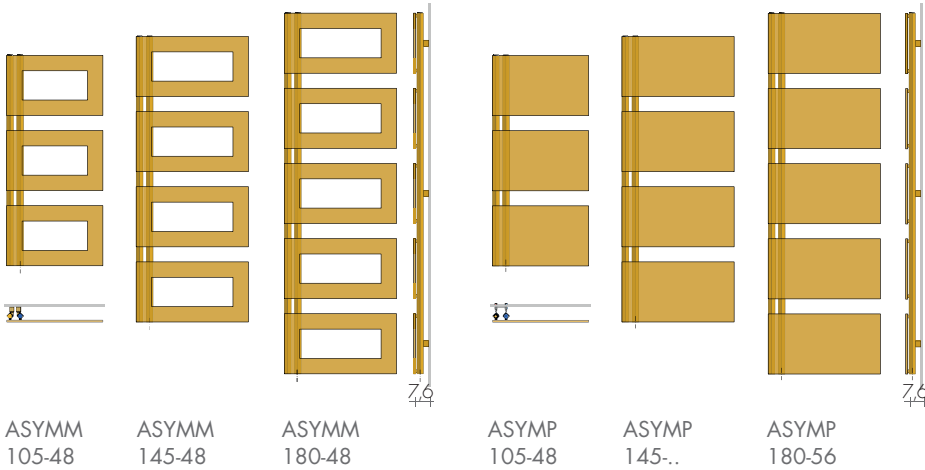

MODEL	H - L cm	Standard white	BREM Colors		KIT HEATING ELEMENT with:		
		sablé SB 9016 €	+15% €	+25% €	Cable R...E Art. (W)	Faston R...T Art. (W)	€
ASYMM	105-48	695,30	799,60	869,10	R500IIE	R500IIT	208,50
ASYMM	145-48	841,60	967,80	1052,00	R650IIE	R650IIT	222,90
ASYMM	180-48	963,30	1107,80	1204,10	R900IIE	R900IIT	255,30
ASYMP	105-48	831,00	955,70	1038,80	R650IIE	R650IIT	222,90
ASYMP	145-48	1018,00	1170,70	1272,50	R800IIE	R800IIT	240,50
ASYMP	145-56	1059,00	1217,90	1323,80	R900IIE	R900IIT	255,30
ASYMP	180-56	1180,70	1357,80	1475,90	R1200IIE	R1200IIT	276,30

HEATING ELEMENT POSITION  
ⓔ Vertical Heating Element

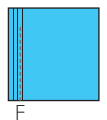

## ELECTRIC VERSIONS

## THERMOSTATS ON THE RADIATOR FOR KIT RT P. 209

THERMOSTAT mod. DYP



White with white cable cover  
Art. DYPB 89,60€

∅ 7 x 9 x 5 cm



Black with black cable cover  
Art. DYPN 103,40€

REMOTE CONTROL for thermostats DYP

10,8 x 5,3 x 2,3 cm



Art. TIR 41,00€

THERMOSTAT CIRCLE Wi-Fi  
up to 800 W  
heating elements



∅ 6 x 8 x 5 cm



Chrome/Black finish  
Art. CIR-wifi 198,50€



design Davide Diliberto

TECHNICAL DATA p. 120  
ELECTRIC KIT DATA p. 208-209

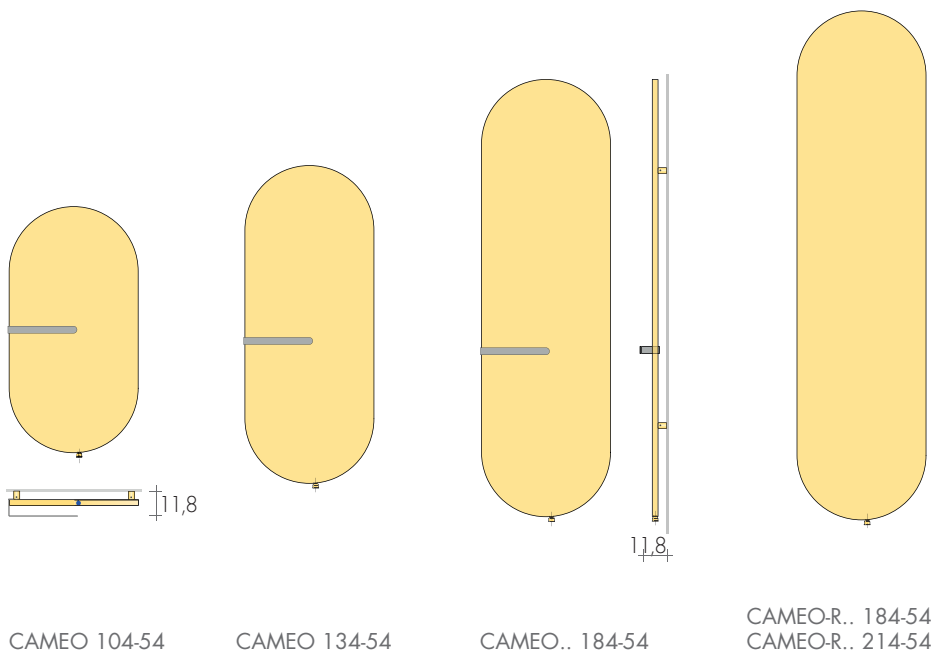

MODEL	H - L cm	Standard white	BREM Colors		KIT HEATING ELEMENT with:		
		sablé SB 9016 €	+15% €	+25% €	Cable R...E Art. (W)	Faston R...T Art. (W)	€
CAMEO 104-54	104-54	1049,30	1206,70	1311,60	R500IIE	R500IIT	208,50
CAMEO 134-54	134-54	1170,30	1345,80	1462,90	R650IIE	R650IIT	222,90
CAMEO 184-54	134-54	1342,40	1543,80	1678,00	R900IIE	R900IIT	255,30
CAMEO-L 184-54	184-54	1585,80	1823,70	1982,30	R1200IIE	R1200IIT	276,30
Models without towel bar - RADIATORS							
CAMEO-R 184-54	184-54	1281,50	1473,70	1601,90	R900IIE	R900IIT	255,30
CAMEO-RL 184-54	184-54	1524,90	1753,60	1906,10	R1200IIE	R1200IIT	276,30
CAMEO-R 214-54	214-54	1382,20	1589,50	1727,80	R1200IIE	R1200IIT	276,30
CAMEO-RL 214-54	214-54	1822,70	2096,10	2278,40	R1500IIE	R1500IIT	298,00

Towel bar on the right side, on request without extra

TOWEL BAR CAMEO: STANDARD COLORS  
- white sablé SB 9016 - quartz grey SB 7039  
- black sablé SB 9005 - same color as the radiator

Additional or deductible towel bar CAMEO  
Art. MCA 60,90€

In one paintwork to Brem color list different from the radiator  
Extra Art. CM 52,90€

HEATING ELEMENT POSITION  
© Vertical Heating Element

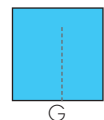

## THERMOSTATS Wi-Fi FOR KIT RE P. 208

## ACCESSORIES FOR



E.H.E. white cable cover  
or radiator color (together)  
Art.CCRE38 ø3/8" 73,40€  
Art.CCRE12 ø1/2" 73,40€

The KIT RT Wi-Fi includes:  
- Thermostat RT (battery)  
- Gateway  
- Built-in receiver

Art. KITRT-wifi 199,80€

Additional receiver  
(up to 6) radiators)



Art. SA868 64,20€

KIT ELY Wi-Fi TOP DESIGN includes:  
- Thermostat with magnetic charging base  
and magnetic plate for wall mounting  
- Gateway a 230V  
- Built-in Receiver

Art. KITELY-wifi 396,10€

Additional receiver: 1 for each electrical radiators  
or split AC (up to 16) Art. SA600 99,10€



TECHNICAL DATA  
and other dimensions p.168  
ELECTRIC KIT DATA p. 208-209

design Bettazzi+Percoco Architects

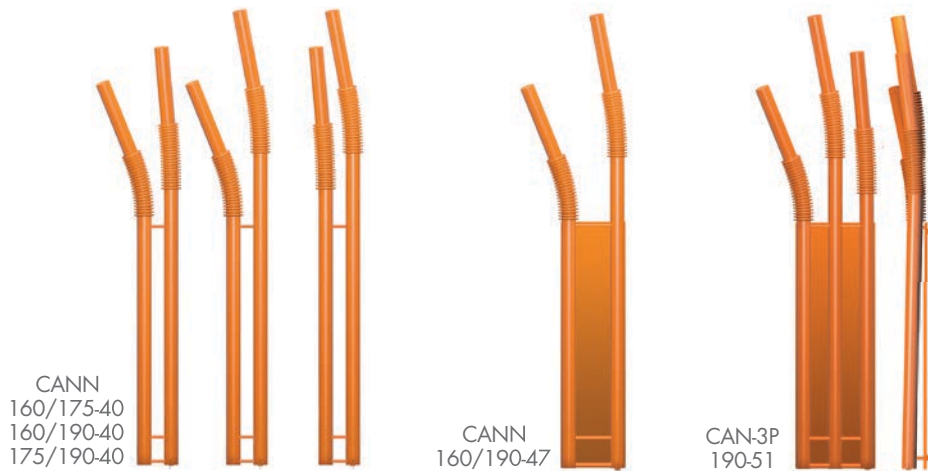
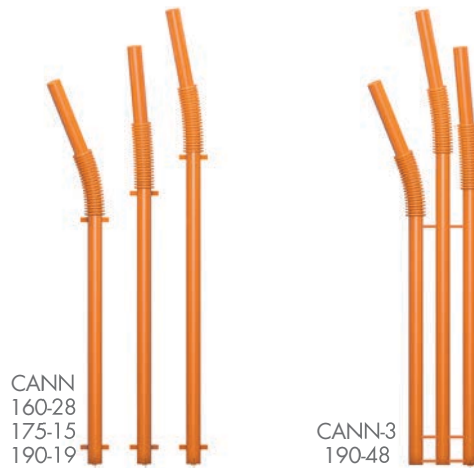

MODEL (STRAW)	H - L cm	Standard white	BREM Colors	BREM Colors	KIT HEATING ELEMENT with:		
		sablé SB 9016 €	+15% €	+25% €	Cable R...E Art. (W)	Faston R...T Art. (W)	€
CANN	160-28	602,60	693,00	753,30	R250IIE	R250IIT	191,90
CANN	175-15	624,50	718,20	780,60	R250IIE	R250IIT	191,90
CANN	190-19	646,20	743,10	807,80	R250IIE	R250IIT	191,90
CANN 160/175-40		973,60	1119,60	1217,00	R300IIE	R300IIT	193,80
CANN 160/190-40		995,20	1144,50	1244,00	R300IIE	R300IIT	193,80
CANN 175/190-27		1017,00	1169,60	1271,30	R400IIE	R400IIT	195,70
CANN-3	190-48	1293,70	1487,80	1617,10	R500IIE	R500IIT	208,50
CAN-P 160/190-47		1272,40	1463,30	1590,50	R650IIE	R650IIT	222,90
CAN-3P	190-51	1570,90	1806,50	1963,60	R800IIE	R800IIT	240,50

TOWEL BAR with wall fixings  
(white or in the radiator color)

Art. MCA 30 84,60€ 30/15 cm (L/p)  
Art. MCA 36 91,30€ 36/18 cm (L/p)



HEATING ELEMENT Position  
©Vertical Heating Element

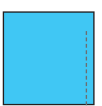

## ELECTRIC VERSIONS

THERMOSTATS IN THE RADIATOR FOR KIT RT P. 209

THERMOSTAT mod. DYP



White with  
white cable cover  
Art. DYPB 89,60€

ø 7 x 9 x 5 cm



Black with  
black cable cover  
Art. DYPN 103,40€

REMOTE CONTROL for thermostats DYP

10,8 x 5,3 x 2,3 cm



Art. TIR 41,00€

THERMOSTAT CIRCLE Wi-Fi  
up to 800 W  
heating elements



ø 6 x 8 x 5 cm



Chrome/Black finish  
Art. CIR-wifi 198,50€



design Davide Diliberto

TECHNICAL DATA and other dimensions p. 150, 170  
ELECTRIC KIT DATA p. 208-209

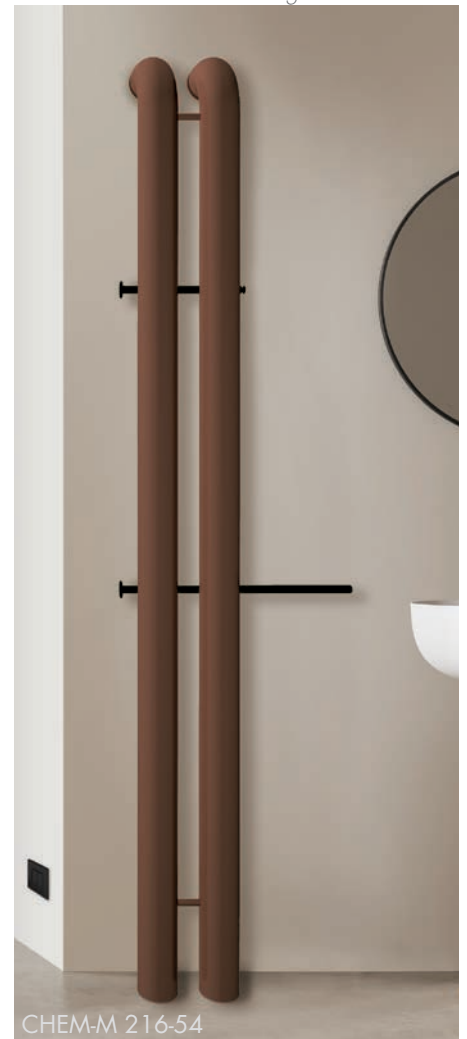
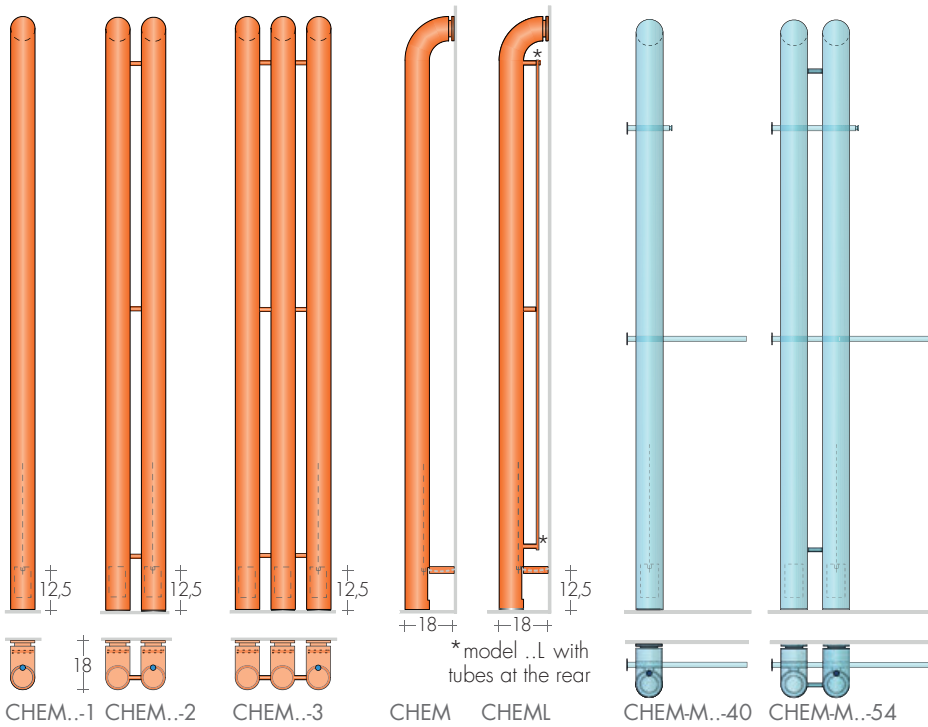

MODEL	H - L cm	Standard white	BREM Colors	BREM Colors	KIT HEATING ELEMENT with:		
		sablé SB 9016 €	+15% €	+25% €	Cable R..E Art. (W)	Faston R..T Art. (W)	€
CHEM	196-1	682,10	784,40	852,60	R300IIE	-	193,80
CHEM	196-2	917,30	1054,90	1146,60	R650IIE	-	222,90
CHEM	196-3	1152,50	1325,40	1440,60	R900IIE	-	255,30
CHEML	196-1	787,90	906,10	984,90	R500IIE	-	208,50
CHEML	196-2	1129,00	1298,40	1411,30	R900IIE	-	255,30
CHEML	196-3	1470,00	1690,50	1837,50	R1500IIE	-	276,00
CHEM	216-1	717,40	825,00	896,80	R400IIE	-	195,70
CHEM	216-2	970,30	1115,80	1212,90	R800IIE	-	240,50
CHEM	216-3	1223,00	1406,50	1528,80	R1200IIE	-	276,30
CHEML	216-1	827,90	952,10	1034,90	R500IIE	-	208,50
CHEML	216-2	1191,30	1370,00	1489,10	R1200IIE	-	276,30
CHEML	216-3	1554,70	1787,90	1943,40	R1500IIE	-	298,00
CHEM-M	196-40	752,60	865,50	940,80	R300IIE	-	193,80
CHEM-M	196-54	987,80	1136,00	1234,80	R650IIE	-	222,90
CHEM-M	216-40	787,90	906,10	984,90	R400IIE	-	195,70
CHEM-M	216-54	1040,80	1196,90	1301,00	R800IIE	-	240,50

CHEM-M, Towel holder and Knob  
standard colors: white sablé SB 9016  
quartz grey SB 7039 jet black SB 9005  
Paintwork to Brem color list Extra Art.CM 52,90€

ONLY with Wi-Fi THERMOSTATS for KIT RE

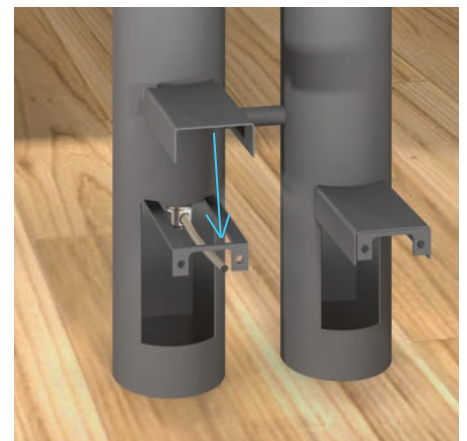

HEATING ELEMENT POSITION  
© Vertical Heating Element

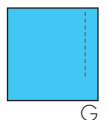

THERMOSTATS Wi-Fi FOR KIT RE P. 208

ACCESSORIES FOR

E.H.E. white cable cover  
integrated in the radiator bracket

The KIT RT Wi-Fi includes:  
- Thermostat RT (battery)  
- Gateway  
- Built-in receiver

Art. KITRT-wifi 199,80€

Additional receiver  
(up to 6) radiators)

Art. SA868 64,20€



KIT ELY Wi-Fi TOP DESIGN includes:  
- Thermostat with magnetic charging base  
and magnetic plate for wall mounting  
- Gateway a 230V  
- Built-in Receiver

Art. KITELY-wifi 396,10€

Additional receiver: 1 for each electrical radiators  
or split AC (up to 16) Art. SA600 99,10€



design Davide Diliberto

TECHNICAL DATA and other dimensions p. 172  
ELECTRIC KIT DATA p. 208-209

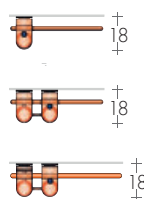

CHEM-S 196-50/..  
216-50/..



CHEM-S 196D-50/..  
216D-50/..

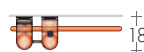

CHEM-S 216DL\*60/..

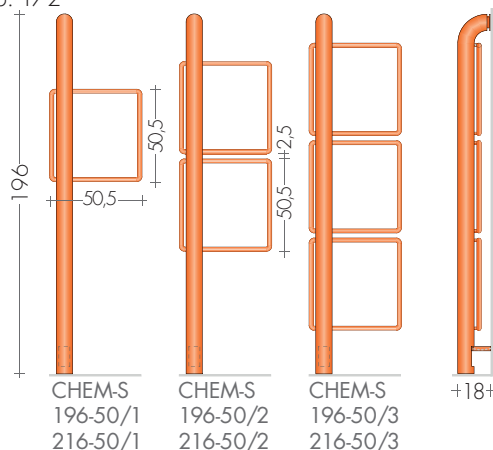

CHEM-S 196-50/1  
216-50/1

CHEM-S 196-50/2  
216-50/2

CHEM-S 196-50/3  
216-50/3

+18+

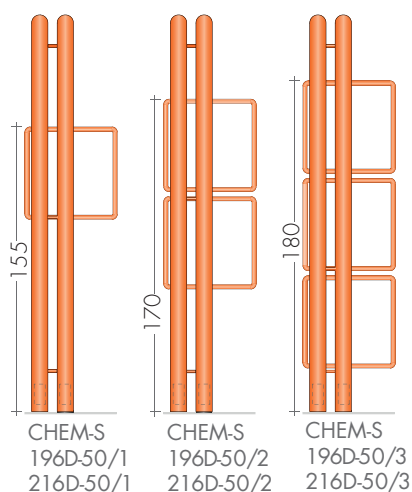

CHEM-S 196D-50/1  
216D-50/1

CHEM-S 196D-50/2  
216D-50/2

CHEM-S 196D-50/3  
216D-50/3

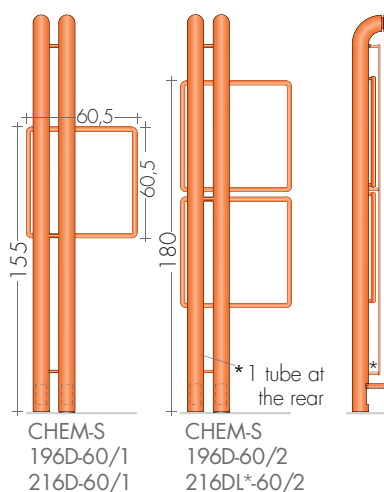

CHEM-S 196D-60/1  
216D-60/1

CHEM-S 196D-60/2  
216DL\*60/2

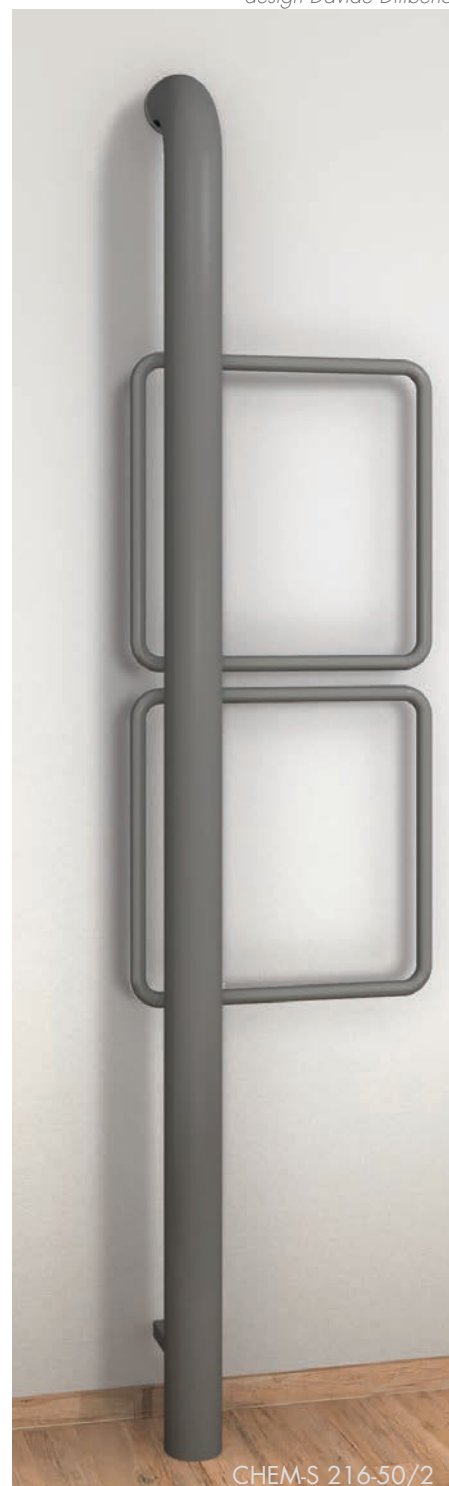

CHEM-S 216-50/2

HEATING ELEMENT POSITION  
© Vertical Heating Element



G

MODEL	H - L cm	Standard white	BREM Colors	BREM Colors	KIT HEATING ELEMENT with:		
		sablé SB 9016 €	+15% €	+25% €	Cable R...E Art. (W)	Faston R...T Art. (W)	€
CHEM-S 196-50/1		764,40	879,10	955,50	R400IIE	-	195,70
CHEM-S 196-50/2		858,50	987,30	1073,10	R500IIE	-	208,50
CHEM-S 196-50/3		952,60	1095,50	1190,80	R650IIE	-	222,90
CHEM-S 196D-50/1		999,60	1149,50	1249,50	R800IIE	-	240,50
CHEM-S 196D-50/2		1093,70	1257,80	1367,10	R900IIE	-	255,30
CHEM-S 196D-50/3		1187,80	1366,00	1484,80	R900IIE	-	255,30
CHEM-S 216-50/1		799,70	919,70	999,60	R500IIE	-	208,50
CHEM-S 216-50/2		893,80	1027,90	1117,30	R500IIE	-	208,50
CHEM-S 216-50/3		987,80	1136,00	1234,80	R650IIE	-	222,90
CHEM-S 216D-50/1		1034,90	1190,10	1293,60	R800IIE	-	240,50
CHEM-S 216D-50/2		1129,00	1298,40	1411,30	R900IIE	-	255,30
CHEM-S 216D-60/1		1059,50	1218,50	1324,40	R900IIE	-	255,30
CHEM-S 216DL-60/2		1331,50	1531,20	1664,40	R1200IIE	-	276,30

ONLY with Wi-Fi THERMOSTATS for KIT RE

## ELECTRIC VERSIONS

THERMOSTATS Wi-Fi FOR KIT RE P. 208

The KIT RT Wi-Fi includes:  
- Thermostat RT (battery)  
- Gateway  
- Built-in receiver

Art. KITRT-wifi 199,80€

Additional receiver  
(up to 6) radiators)

Art. SA868 64,20€



KIT ELY Wi-Fi TOP DESIGN includes:  
- Thermostat with magnetic charging base  
and magnetic plate for wall mounting  
- Gateway a 230V  
- Built-in Receiver

Art. KITELY-wifi 396,10€

Additional receiver: 1 for each electrical radiators  
or split AC (up to 16) Art. SA600 99,10€



TECHNICAL DATA and other dimensions p. 86, 88  
ELECTRIC KIT DATA p. 208-209

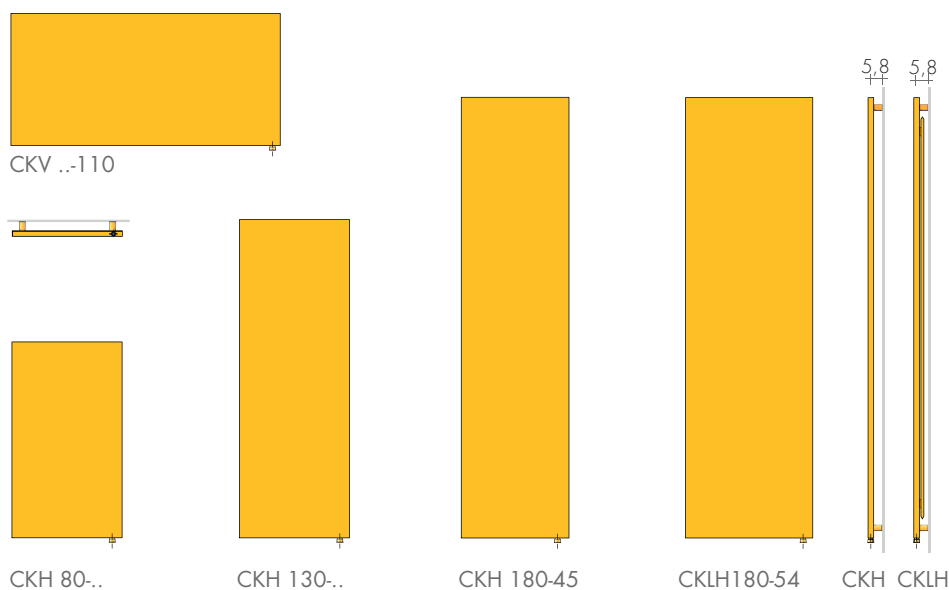

MODEL	H - L cm	Standard white	BREM Colors		KIT HEATING ELEMENT with:		
		sablé SB 9016 €	+15% €	+25% €	Cable R..E Art. (W)	Faston R..T Art. (W)	€
CKV	45-110	1041,20	1197,40	1301,50	R500IIE	R500IIT	208,50
CKV	54-110	1110,20	1276,70	1387,80	R650IIE	R650IIT	222,90
CKH	80-45	788,30	906,50	985,40	R400IIE	R400IIT	195,70
CKH	80-54	866,10	996,00	1082,60	R500IIE	R500IIT	208,50
CKH	130-45	951,40	1094,10	1189,30	R650IIE	R650IIT	222,90
CKH	130-54	1040,00	1196,00	1300,00	R800IIE	R800IIT	240,50
CKH	180-36	1018,90	1171,70	1273,60	R800IIE	R800IIT	240,50
CKH	180-45	1114,40	1281,60	1393,00	R900IIE	R900IIT	255,30
CKLH	180-36	1319,40	1517,30	1649,30	R900IIE	R900IIT	255,30
CKLH	180-45	1430,50	1645,10	1788,10	R1200IIE	R1200IIT	276,30
CKLH	180-54	1566,70	1801,70	1958,40	R1500IIE	R1500IIT	298,00
CKH	200-54	1274,10	1465,20	1592,60	R1200IIE	R1200IIT	276,30
CKLH	200-54	1694,40	1948,60	2118,00	R1500IIE	R1500IIT	298,00

CLAK-FO/FA Gilded Leaf/Silver Leaf: Price x 1,9

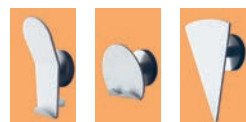

KNOBS with magnet  
page 277

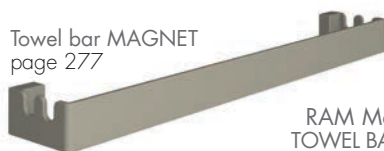

Towel bar MAGNET  
page 277

RAM Magnetic  
TOWEL BAR  
page 277



HEATING ELEMENT POSITION  
© Vertical Heating Element

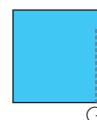

## THERMOSTATS Wi-Fi FOR KIT RE P. 208

## ACCESSORIES FOR



E.H.E. white cable cover  
or radiator color (together)  
Art.CCRE38 ø3/8" 73,40€  
Art.CCRE12 ø1/2" 73,40€

The KIT RT Wi-Fi includes:  
- Thermostat RT (battery)  
- Gateway  
- Built-in receiver

Art. KITRT-wifi 199,80€

Additional receiver  
(up to 6) radiators)



Art. SA868 64,20€

KIT ELY Wi-Fi TOP DESIGN includes:  
- Thermostat with magnetic charging base  
and magnetic plate for wall mounting  
- Gateway a 230V  
- Built-in Receiver

Art. KITELY-wifi 396,10€

Additional receiver: 1 for each electrical radiators  
or split AC (up to 16) Art. SA600 99,10€



TECHNICAL DATA and other dimensions p. 122  
ELECTRIC KIT DATA p. 208-209

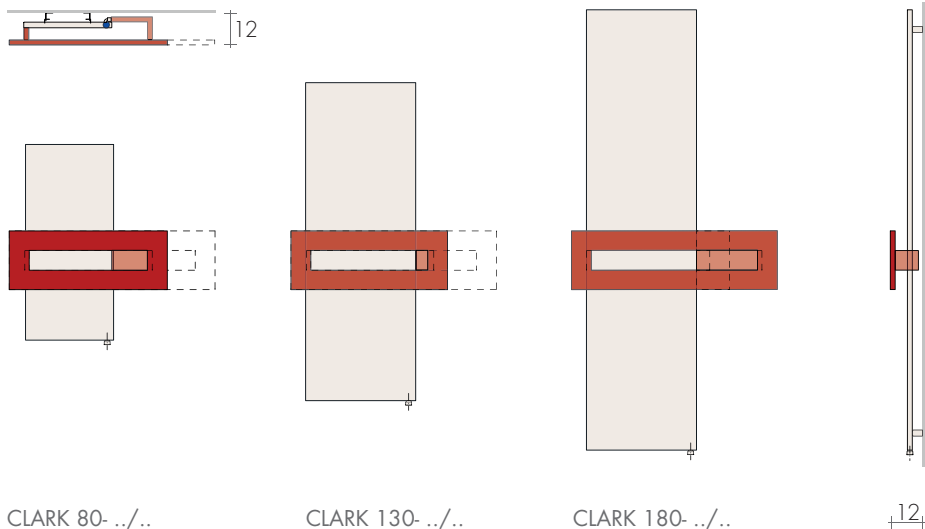

CLARK 80- ../..

CLARK 130- ../..

CLARK 180- ../..

MODEL	H - L cm	Standard white	BREM Colors		KIT HEATING ELEMENT with:		
		sablé SB 9016 €	+15% €	+25% €	Cable R. E Art. (W)	Faston R. T Art. (W)	€
CLARK	80-36/64	1102,40	1267,80	1378,00	R500IIE	R500IIT	208,50
CLARK	80-45/84	1233,10	1418,10	1541,40	R650IIE	R650IIT	222,90
CLARK	130-36/64	1233,00	1418,00	1541,30	R650IIE	R650IIT	222,90
CLARK	130-45/84	1396,10	1605,50	1745,10	R800IIE	R800IIT	240,50
CLARK	180-36/64	1431,60	1646,30	1789,50	R900IIE	R900IIT	255,30
CLARK	180-45/84	1559,00	1792,90	1948,80	R1200IIE	R1200IIT	276,30

### TOWEL BAR CLARK

STANDARD COLORS:  
- white sablé SB9016  
- grey sablé SB7039  
- black sablé SB9005  
- same color ordered with the radiator +15/25%  
Paintwork to Brem color list Extra Art. CMC74,50€



HEATING ELEMENT POSITION  
© Vertical Heating Element



## ELECTRIC VERSIONS

### THERMOSTATS IN THE RADIATOR FOR KIT RT P. 209

#### THERMOSTAT mod. DYP



White with  
white cable cover  
Art. DYPB 89,60€

ø 7 x 9 x 5 cm



Black with  
black cable cover  
Art. DYPN 103,40€

#### REMOTE CONTROL for thermostats DYP

10,8 x 5,3 x 2,3 cm



Art. TIR 41,00€

#### THERMOSTAT CIRCLE Wi-Fi up to 800 W heating elements



ø 6 x 8 h x 5 cm



Chrome/Black finish  
Art. CIR-wifi 198,50€



# e.CROSS WITH CROSSED SQUARES

PRICE FROM 01.03.2026 +5%

design Luigi Brembilla

TECHNICAL DATA and other dimensions p. 56  
ELECTRIC KIT DATA p. 208-209

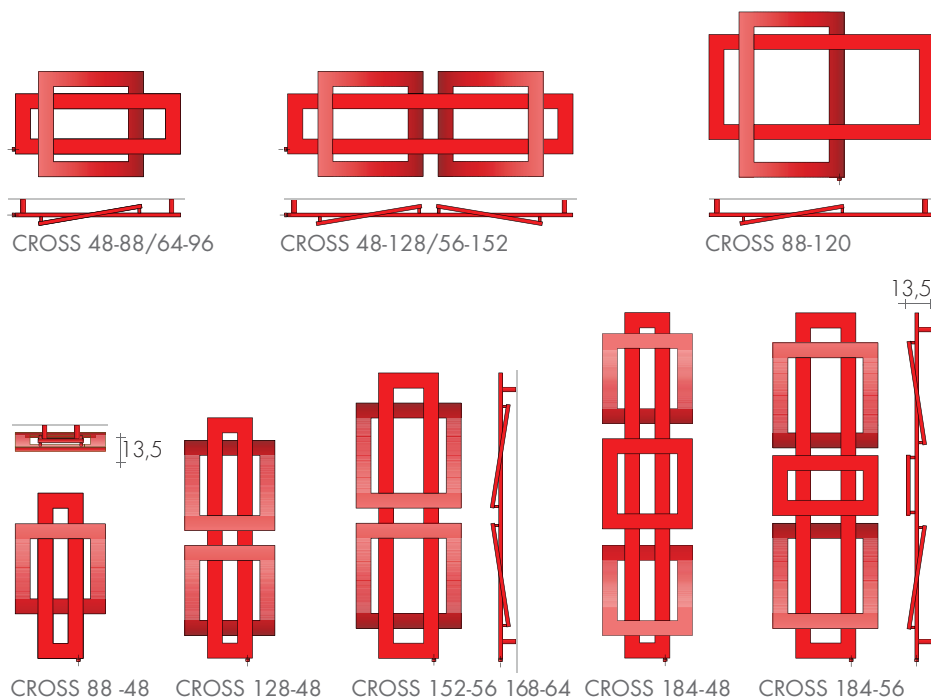

MODEL	H - L cm	Standard white	BREM Colors		KIT HEATING ELEMENT with:		
		sablé SB 9016 €	+15% €	+25% €	Cable R...E Art. (W)	Faston R...T Art. (W)	€
CROSS 48-88	48-88	768,20	883,40	960,30	R400IIE	R400IIT	195,70
CROSS 48-128	48-128	1066,50	1226,50	1333,10	R650IIE	R650IIT	222,90
CROSS 56-152	56-152	1156,10	1329,50	1445,10	R800IIE	R800IIT	240,50
CROSS 64-96	64-96	867,60	997,70	1084,50	R500IIE	R500IIT	208,50
CROSS 88-48	88-48	754,00	867,10	942,50	R400IIE	R400IIT	195,70
CROSS 88-120	88-120	939,50	1080,40	1174,40	R650IIE	R650IIT	222,90
CROSS 128-48	128-48	1058,30	1217,00	1322,90	R650IIE	R650IIT	222,90
CROSS 152-56	152-56	1146,10	1318,00	1432,60	R800IIE	R800IIT	240,50
CROSS 168-64	168-64	1224,90	1408,60	1531,10	R900IIE	R900IIT	255,30
CROSS 184-48	184-48	1375,70	1582,10	1719,60	R900IIE	R900IIT	255,30
CROSS 184-56	184-56	1434,70	1649,90	1793,40	R900IIE	R900IIT	255,30

HEATING EL. POSITION  
 ☉ Horizontal Heating El.  
 ☉ Vertical Heating El.

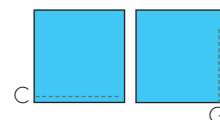

## THERMOSTATS Wi-Fi FOR KIT RE P. 208

## ACCESSORIES FOR

E.H.E. white cable cover  
or radiator color (together)  
Art.CCRE38 ø3/8" 73,40€  
Art.CCRE12 ø1/2" 73,40€



The KIT RT Wi-Fi includes:  
 - Thermostat RT (battery)  
 - Gateway  
 - Built-in receiver

Art. KITRT-wifi 199,80€

Additional receiver  
(up to 6) radiators)



Art. SA868 64,20€

KIT ELY Wi-Fi TOP DESIGN includes:  
 - Thermostat with magnetic charging base  
and magnetic plate for wall mounting  
- Gateway a 230V  
- Built-in Receiver

Art. KITELY-wifi 396,10€

Additional receiver: 1 for each electrical radiators  
or split AC (up to 16) Art. SA600 99,10€



# e.CROSS-CROM WITH OVERLAPPING SQUARES

# e.CROSS-FO/FA GILDED/SILVER LEAF

PRICE FROM 01.03.2026 **+5%**  
design Luigi Brembilla

TECHNICAL DATA and other dimensions p. 63  
ELECTRIC KIT DATA p. 208-209

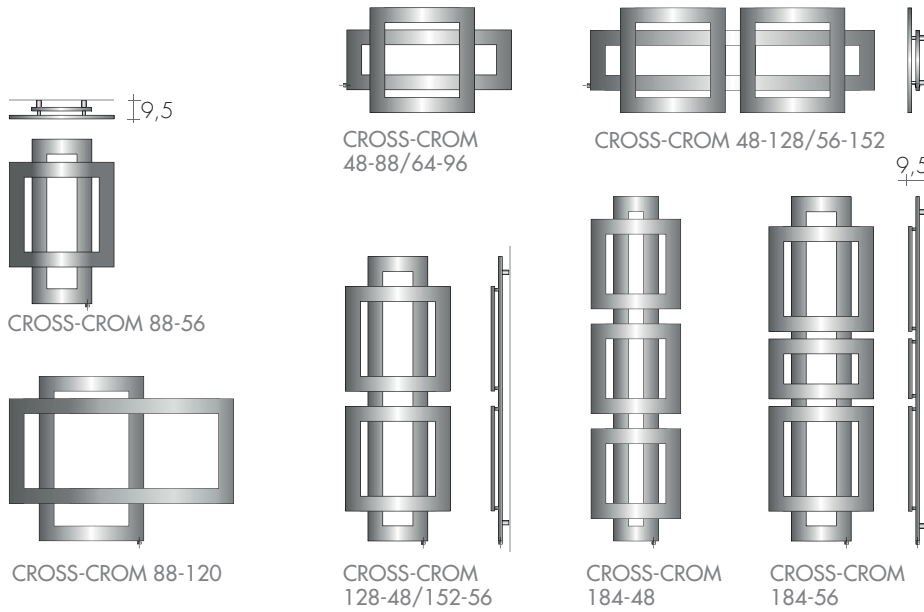

MODEL WITH OVERLAPPING SQUARES	H-L cm	Chrome-plated standard €
Cross CROM 48-88	48-88	1790,00
Cross CROM 48-128	48-128	2484,90
Cross CROM 56-152	56-152	2693,70
Cross CROM 64-96	64-96	2021,70
Cross CROM 88-56	88-56	1828,50
Cross CROM 88-120	88-120	2188,40
Cross CROM 128-48	128-48	2465,20
Cross CROM 152-56	152-56	2670,40
Cross CROM 184-48	184-48	3543,90
Cross CROM 184-56	184-56	3695,80

KIT HEATING ELEMENT with:		
Cable R...E Art. (WV)	Faston R...T Art. (WV)	€
R300IIE	R300IIT	193,80
R500IIE	R500IIT	208,50
R650IIE	R650IIT	222,90
R400IIE	R400IIT	195,70
R400IIE	R400IIT	195,70
R500IIE	R500IIT	208,50
R500IIE	R500IIT	208,50
R650IIE	R650IIT	222,90
R800IIE	R800IIT	240,50
R900IIE	R900IIT	255,30

MODEL WITH OVERLAPPING SQUARES	H-L cm	Gilded/Silver leaf €
Cross FO/FA 48-88	48-88	2151,20
Cross FO/FA 48-128	48-128	2986,00
Cross FO/FA 64-96	64-96	2429,10
Cross FO/FA 88-48	88-48	2111,00
Cross FO/FA 88-120	88-120	2284,70
Cross FO/FA 128-48	128-48	2630,20
Cross FO/FA 152-56	152-56	3093,10
Cross FO/FA 168-64	168-64	3209,40
Cross FO/FA 184-48	184-48	3348,70
Cross FO/FA 184-56	184-56	3492,50

KIT HEATING ELEMENT with:		
Cable R...E Art. (WV)	Faston R...T Art. (WV)	€
R400IIE	R400IIT	195,70
R650IIE	R650IIT	222,90
R500IIE	R500IIT	208,50
R400IIE	R400IIT	195,70
R650IIE	R650IIT	222,90
R800IIE	R800IIT	240,50
R900IIE	R900IIT	255,30
R900IIE	R900IIT	255,30
R900IIE	R900IIT	255,30

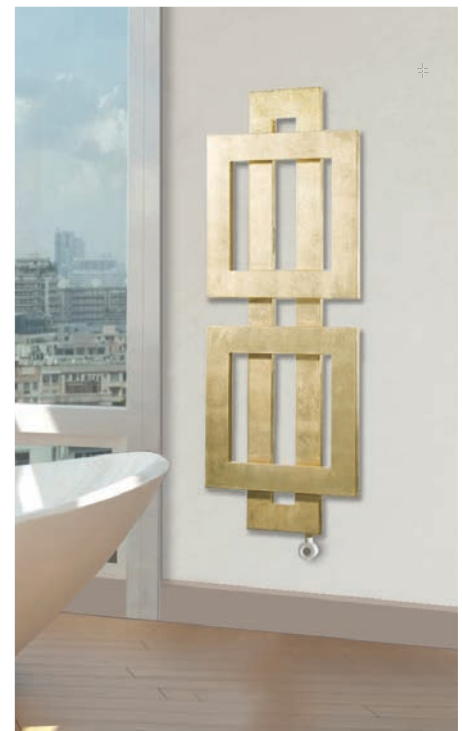

HEATING EL. POSITION  
 © Horizontal Heating El.  
 Ⓞ Vertical Heating El.

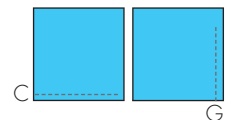

## ELECTRIC VERSIONS

## THERMOSTATS IN THE RADIATOR FOR KIT RT P. 209

THERMOSTAT mod. DYP



White with white cable cover  
Art. DYPB 89,60€

ø 7 x 9 x 5 cm



Black with black cable cover  
Art. DYPN 103,40€

REMOTE CONTROL for thermostats DYP

10,8 x 5,3 x 2,3 cm



Art. TIR 41,00€

THERMOSTAT CIRCLE Wi-Fi  
up to 800 W heating elements



ø 6 x 8 x 5 cm



Chrome/Black finish  
Art. CIR-wifi 198,50€



# e.CROSS-G - e.CROSS-V

PRICE FROM 01.03.2026 **+5%**

TECHNICAL DATA and other dimensions  
 CROSS-G page 46, CROSS-V page 50  
 ELECTRIC KIT DATA page 208-209

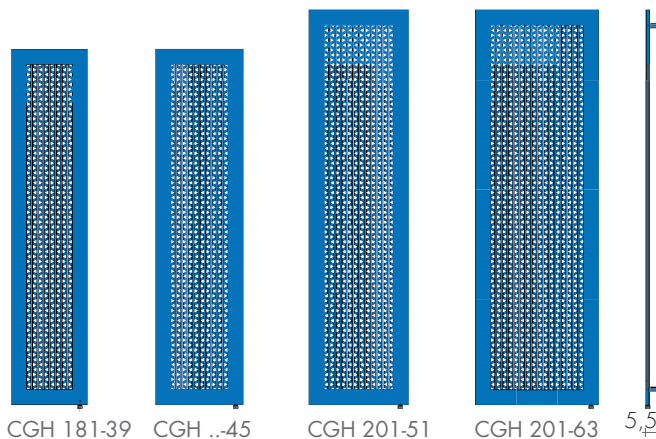

CGH 181-39 CGH ...45 CGH 201-51 CGH 201-63 5,5

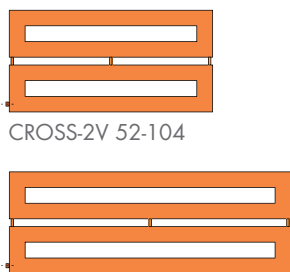

CROSS-2V 52-104

CROSS-V 52-144

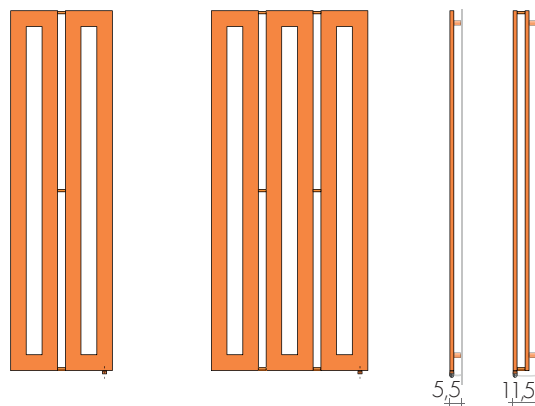

CROSS-..V ...52 CROSS-V ...80 CROSS-V ...2V 5,5 1,5



MODEL	H - L cm	Standard white sablé SB 9016 €	BREM Colors		KIT HEATING ELEMENT with:		
			+15% €	+25% €	Cable R...E Art. (W)	Faston R...T Art. (W)	€
CGH	181-39	1159,20	1333,10	1449,00	R800IIE	R800IIT	240,50
CGH	181-45	1216,30	1398,70	1520,40	R900IIE	R900IIT	255,30
CGH	201-45	1284,20	1476,80	1605,30	R900IIE	R900IIT	255,30
CGH	201-51	1341,40	1542,60	1676,80	R1200IIE	R1200IIT	276,30
CGH	201-63	1455,90	1674,30	1819,90	R1500IIE	R1500IIT	298,00
CROSS-V	52-144	772,20	888,00	965,30	R650IIE	R650IIT	222,90
CROSS-2V	52-104	1140,80	1311,90	1426,00	R900IIE	R900IIT	255,30
CROSS-2V	52-144	1467,00	1687,10	1833,80	R1200IIE	R1200IIT	276,30
CROSS-V	184-52	1059,20	1218,10	1324,00	R900IIE	R900IIT	255,30
CROSS-V	184-80	1465,30	1685,10	1831,60	R1200IIE	R1200IIT	276,30
CROSS-V	208-80	1512,60	1739,50	1890,80	R1500IIE	R1500IIT	298,00
CROSS-2V	184-52	1059,20	1218,10	1324,00	R1500IIE	R1500IIT	298,00

Other sizes on request

HEATING EL. POSITION  
 © Horizontal Heating El.  
 © Vertical Heating El.

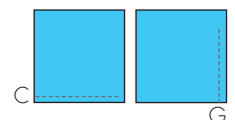

## THERMOSTATS Wi-Fi FOR KIT RE P. 208

## ACCESSORIES FOR



E.H.E. white cable cover  
 or radiator color (together)  
 Art.CCRE38 ø3/8" 73,40€  
 Art.CCRE12 ø1/2" 73,40€

The KIT RT Wi-Fi includes:  
 - Thermostat RT (battery)  
 - Gateway  
 - Built-in receiver

Art. KITRT-wifi 199,80€

Additional receiver  
 (up to 6) radiators)



Art. SA868 64,20€

KIT ELY Wi-Fi TOP DESIGN includes:  
 - Thermostat with magnetic charging base  
 and magnetic plate for wall mounting  
 - Gateway a 230V  
 - Built-in Receiver

Art. KITELY-wifi 396,10€

Additional receiver: 1 for each electrical radiators  
 or split AC (up to 16) Art. SA600 99,10€



# e.CROSS-Q WITH OVERLAPPING SQUARES

PRICE FROM 01.03.2026 +5%

design Luigi Brembilla

TECHNICAL DATA and other dimensions p. 60  
ELECTRIC KIT DATA p. 208-209

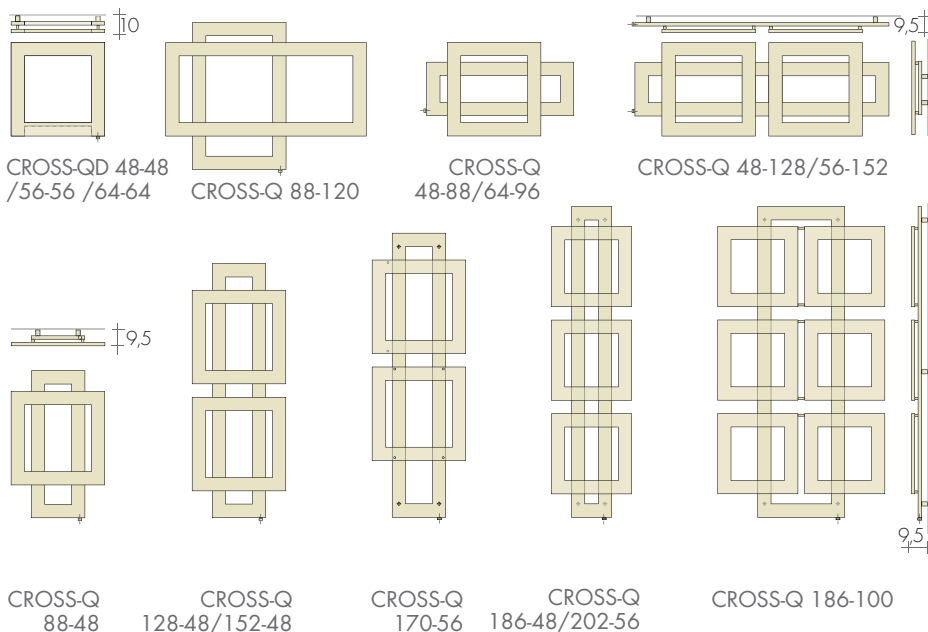

MODEL	H - L cm	Standard white	BREM Colors	BREM Colors	KIT HEATING ELEMENT with:		
		sablé SB 9016 €	+15% €	+25% €	Cable R...E Art. (W)	Faston R...T Art. (W)	€
CROSS-QD 48-48	48-48	465,40	535,20	581,80	R250IIE	R250IIT	191,90
CROSS-QD 56-56	56-56	506,70	582,70	633,40	R300IIE	R300IIT	193,80
CROSS-QD 64-64	64-64	531,80	611,60	664,80	R400IIE	R400IIT	195,70
CROSS-Q 48-88	48-88	731,70	841,50	914,60	R400IIE	R400IIT	195,70
CROSS-Q 48-128	48-128	1015,70	1168,10	1269,60	R650IIE	R650IIT	222,90
CROSS-Q 56-152	56-152	1101,00	1266,20	1376,30	R800IIE	R800IIT	240,50
CROSS-Q 64-96	64-96	826,10	950,00	1032,60	R500IIE	R500IIT	208,50
CROSS-Q 88-48	88-48	718,10	825,80	897,60	R400IIE	R400IIT	195,70
CROSS-Q 88-120	88-120	894,50	1028,70	1118,10	R650IIE	R650IIT	206,40
CROSS-Q 128-48	128-48	1008,00	1159,20	1260,00	R650IIE	R650IIT	222,90
CROSS-Q 152-48	152-48	1059,70	1218,70	1324,60	R650IIE	R650IIT	222,90
CROSS-Q 170-56	170-56	1290,40	1484,00	1613,00	R800IIE	R800IIT	240,50
CROSS-Q 186-48	186-48	1310,20	1506,70	1637,80	R900IIE	R900IIT	255,30
CROSS-Q 186-100	186-100	2132,50	2452,40	2665,60	R1500IIE	R1500IIT	298,00
CROSS-Q 202-56	202-56	1374,60	1580,80	1718,30	R1200IIE	R1200IIT	276,30

HEATING EL. POSITION  
 © Horizontal Heating El.  
 © Vertical Heating El.

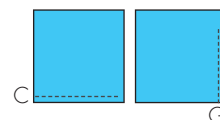

## ELECTRIC VERSIONS

THERMOSTATS IN THE RADIATOR FOR KIT RT P. 209

THERMOSTAT mod. DYP



White with white cable cover  
Art. DYPB 89,60€

ø 7 x 9 x 5 cm



Black with black cable cover  
Art. DYPN 103,40€

REMOTE CONTROL for thermostats DYP

10,8 x 5,3 x 2,3 cm



Art. TIR 41,00€

THERMOSTAT CIRCLE Wi-Fi  
up to 800 W  
heating elements



ø 6 x 8 h x 5 cm



Chrome/Black finish  
Art. CIR-wifi 198,50€



ELECTRIC



design Luigi Brembilla

TECHNICAL DATA and other dimensions p. 66  
ELECTRIC KIT DATA p. 208-209

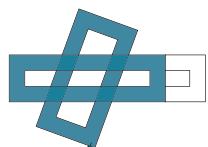

CROSS-R 70-104/124  
R-CROM 70-124

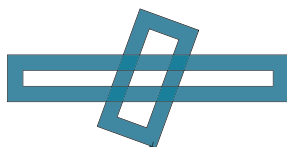

CROSS-R 70-144

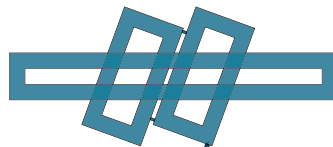

CROSS-R2 70-144/164

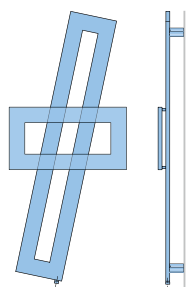
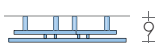

CROSS-R 137-56  
R-CROM 137-64

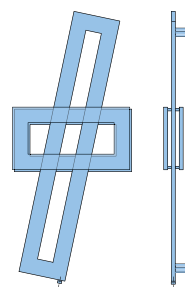
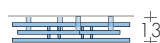

CROSS-RD 137-56

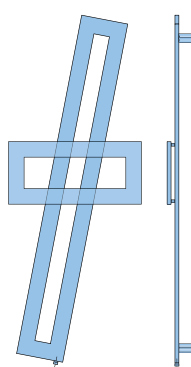

R-CROM 177-64

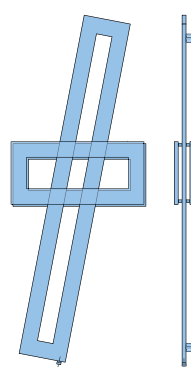

CROSS-RD 177-64

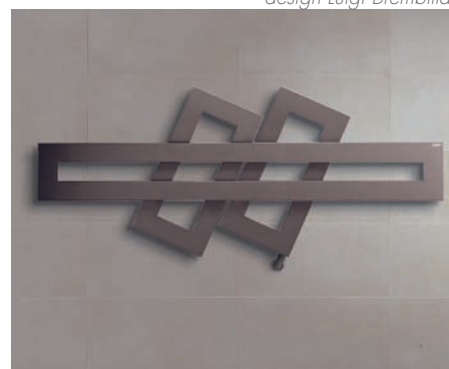

MODELE	H - L cm	Standard white	BREM Colors	BREM Colors	KIT HEATING ELEMENT with:		
		sablé SB 9016 €	+15% €	+25% €	Cable R..E Art. (W)	Faston R..T Art. (W)	€
CROSS-R	70-104	829,80	954,30	1037,30	R400IIE	R400IIT	195,70
CROSS-R	70-124	908,10	1044,30	1135,10	R500IIE	R500IIT	208,50
CROSS-R	70-144	986,40	1134,40	1233,00	R500IIE	R500IIT	208,50
CROSS-R2	70-144	1259,80	1448,80	1574,80	R650IIE	R650IIT	222,90
CROSS-R2	70-164	1443,70	1660,30	1804,60	R800IIE	R800IIT	240,50
CROSS-R	137-56	919,30	1057,20	1149,10	R500IIE	R500IIT	208,50
CROSS-RD	137-56	1244,00	1430,60	1555,00	R650IIE	R650IIT	222,90
CROSS-RD	177-64	1382,00	1589,30	1727,50	R800IIE	R800IIT	240,50
CHROME FINISH							
R-CROM	70-124	2152,30	-	-	R400IIE	R400IIT	195,70
R-CROM	137-56	2262,00	-	-	R500IIE	R500IIT	208,50
R-CROM	177-64	2730,10	-	-	R500IIE	R500IIT	208,50

HEATING ELEMENT POSITION  
© Vertical Heating Element



## THERMOSTATS Wi-Fi FOR KIT RE P. 208

## ACCESSORIES FOR

E.H.E. white cable cover  
or radiator color (together)  
Art.CCRE38 ø3/8" 73,40€  
Art.CCRE12 ø1/2" 73,40€



The KIT RT Wi-Fi includes:  
- Thermostat RT (battery)  
- Gateway  
- Built-in receiver

Art. KITRT-wifi 199,80€

Additional receiver  
(up to 6) radiators)



Art. SA868 64,20€

KIT ELY Wi-Fi TOP DESIGN includes:  
- Thermostat with magnetic charging base  
and magnetic plate for wall mounting  
- Gateway a 230V  
- Built-in Receiver

Art. KITELY-wifi 396,10€

Additional receiver: 1 for each electrical radiators  
or split AC (up to 16) Art. SA600 99,10€



TECHNICAL DATA p. 124  
ELECTRIC KIT DATA p. 208-209

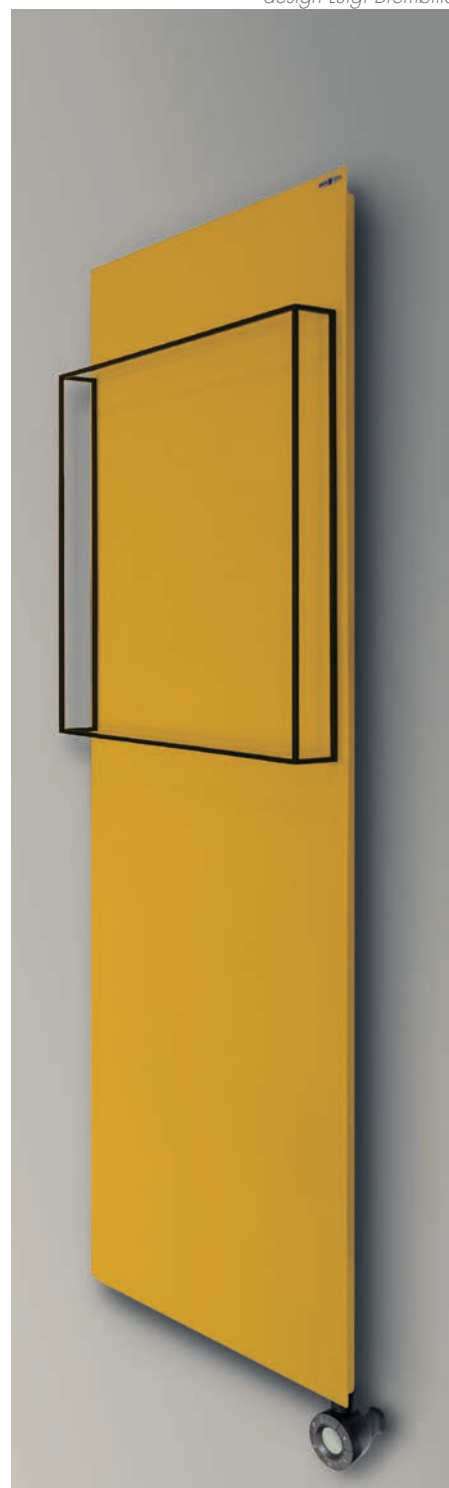
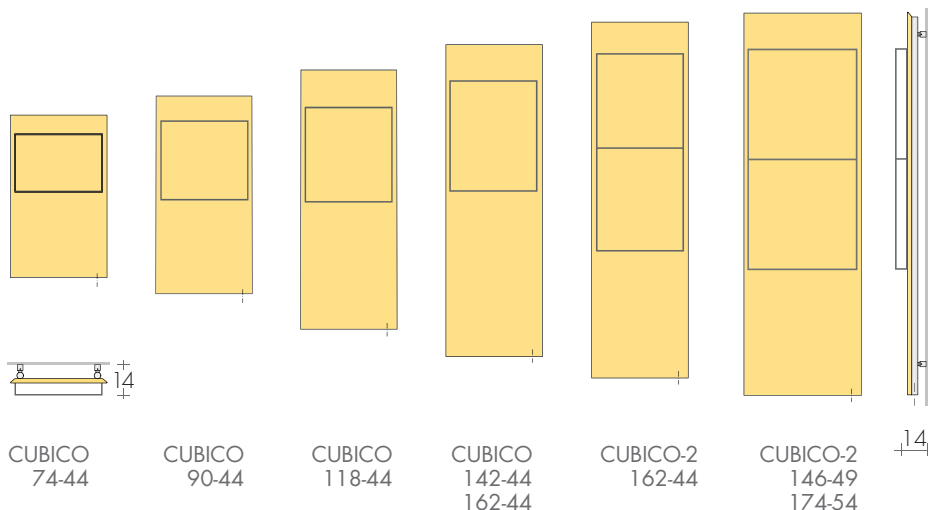

MODELE'25	H - L cm	Standard white sablé SB 9016 €	BREM Colors		KIT HEATING ELEMENT with:		
			+15% €	+25% €	Cable R..E Art. (W)	Faston R..T Art. (W)	€
CUBICO	74-44	708,70	815,00	885,90	R400IIE	R400IIT	195,70
CUBICO	90-44	785,10	902,90	981,40	R500IIE	R500IIT	208,50
CUBICO	118-44	870,10	1000,60	1087,60	R650IIE	R650IIT	222,90
CUBICO	142-44	944,30	1085,90	1180,40	R800IIE	R800IIT	240,50
CUBICO	162-44	1006,40	1157,40	1258,00	R900IIE	R900IIT	255,30
CUBICO-2	162-44	1040,00	1196,00	1300,00	R900IIE	R900IIT	255,30
CUBICO-2	146-49	1026,30	1180,20	1282,90	R900IIE	R900IIT	255,30
CUBICO-2	174-54	1111,90	1278,70	1389,90	R1200IIE	R1200IIT	276,30

TOWEL BAR CUBICO: STANDARD COLORS  
 - white sablé SB 9016 - quartz grey SB 7039  
 - black sablé SB 9005 - same color as the radiator  
 In one paintwork to Brem color list different from the radiator  
 Extra Art.CM 52,90€

HEATING ELEMENT POSITION  
 © Vertical Heating Element



## ELECTRIC VERSIONS

THERMOSTATS IN THE RADIATOR FOR KIT RT P. 209

THERMOSTAT mod. DYP



White with  
white cable cover  
Art. DYPB 89,60€

ø 7 x 9 x 5 cm



Black with  
black cable cover  
Art. DYPN 103,40€

REMOTE CONTROL for thermostats DYP

10,8 x 5,3 x 2,3 cm



Art. TIR 41,00€

THERMOSTAT CIRCLE Wi-Fi  
 up to 800 W  
 heating elements



ø 6 x 8 h x 5 cm



Chrome/Black finish  
 Art. CIR-wifi 198,50€



design Luigi Brebilla

TECHNICAL DATA p. 126  
ELECTRIC KIT DATA p. 208-209

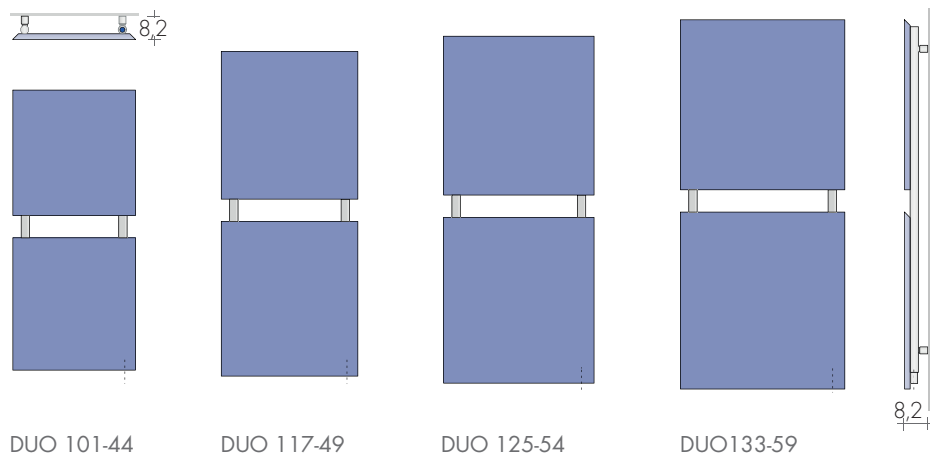

DUO 101-44

DUO 117-49

DUO 125-54

DUO 133-59

MODEL	H - L cm	Standard white	BREM Colors	BREM Colors	KIT HEATING ELEMENT with		
		sablé SB 9016 €	+15% €	+25% €	Cable R..E Art. (W)	Faston R..T Art. (W)	€
DUO	101-44	685,90	788,80	857,40	R500IIE	R500IIT	208,50
DUO	117-49	820,20	943,20	1025,30	R650IIE	R650IIT	222,90
DUO	125-54	878,50	1010,30	1098,10	R800IIE	R800IIT	240,50
DUO	133-59	918,70	1056,50	1148,40	R900IIE	R900IIT	255,30

### BICOLOR SOLUTION:

- BIC10 Cover in a Brem color and back radiator white sablé SB9016 +10%  
Cover in standard white and back in Ral color +10%
- BIC20 Cover in a Brem color and back radiator black sablé SB9005 or grey sablé SB7039 +20%
- BIC35 N° 2 Brem colors of your choice +35%



HEATING ELEMENT POSITION  
© Vertical Heating Element

### THERMOSTATS Wi-Fi FOR KIT RE P. 208

### ACCESSORIES FOR



E.H.E. white cable cover  
or radiator color (together)  
Art.CCRE38 ø3/8" 73,40€  
Art.CCRE12 ø1/2" 73,40€

The KIT RT Wi-Fi includes:  
- Thermostat RT (battery)  
- Gateway  
- Built-in receiver

Art. KITRT-wifi 199,80€

Additional receiver  
(up to 6) radiators)



Art. SA868 64,20€

KIT ELY Wi-Fi TOP DESIGN includes:  
- Thermostat with magnetic charging base  
and magnetic plate for wall mounting  
- Gateway a 230V  
- Built-in Receiver

Art. KITELY-wifi 396,10€

Additional receiver: 1 for each electrical radiators  
or split AC (up to 16)



Art. SA600 99,10€



TECHNICAL DATA and other dimensions p. 70  
ELECTRIC KIT DATA p. 208-209

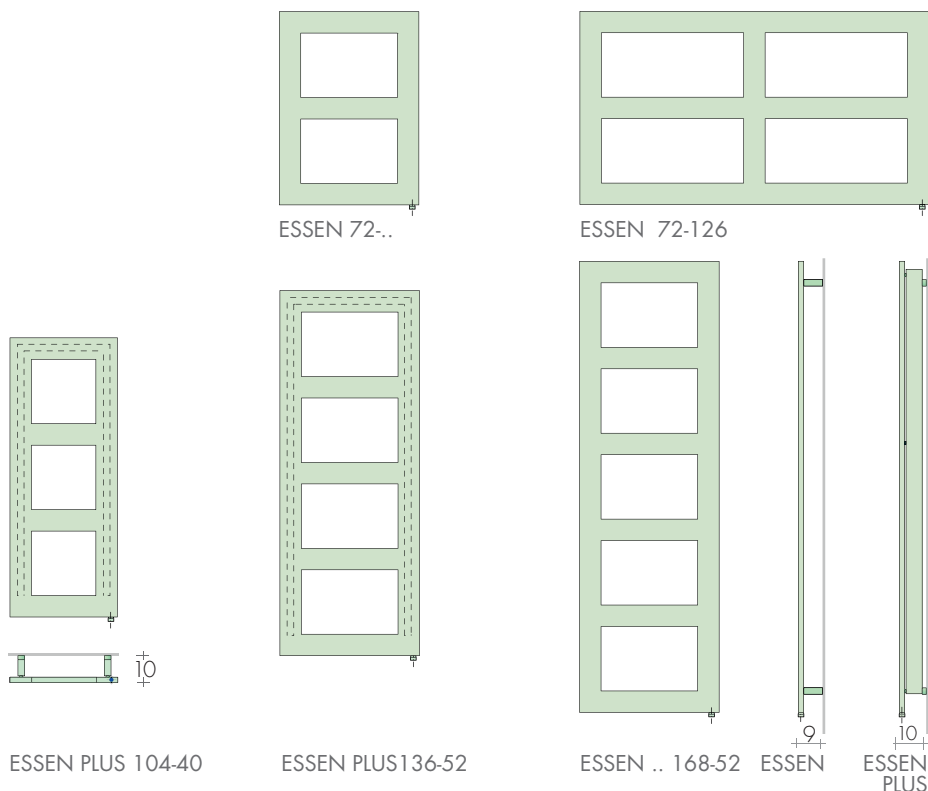

HEATING ELEMENT POSITION  
© Vertical Heating Element



MODEL	H - L cm	Standard white	BREM Colors		KIT HEATING ELEMENT with		
		sablé SB 9016 €	+15% €	+25% €	Cable R...E Art. (W)	Faston R...T Art. (W)	€
ESSEN	72-40	632,10	726,90	790,10	R250IIE	R250IIT	191,90
ESSEN PLUS	72-52	822,10	945,40	1027,60	R400IIE	R400IIT	195,70
ESSEN	72-126	943,30	1084,80	1179,10	R650IIE	R650IIT	222,90
ESSEN PLUS	104-40	828,00	952,20	1035,00	R500IIE	R500IIT	208,50
ESSEN	136-52	822,50	945,90	1028,10	R500IIE	R500IIT	208,50
ESSEN PLUS	136-52	1183,50	1361,00	1479,40	R800IIE	R800IIT	240,50
ESSEN	168-52	972,40	1118,30	1215,50	R650IIE	R650IIT	222,90
ESSEN PLUS	168-52	1312,50	1509,40	1640,60	R900IIE	R900IIT	255,30
CHROME FINISH							
Essen CROM	136-52	1928,80	-	-	R400IIE	R400IIT	195,70
Essen CROM	168-52	2138,60	-	-	R500IIE	R500IIT	208,50

## ELECTRIC VERSIONS

## THERMOSTATS IN THE RADIATOR FOR KIT RT P. 209

THERMOSTAT mod. DYP



White with  
white cable cover  
Art. DYPB 89,60€

ø 7 x 9 x 5 cm



Black with  
black cable cover  
Art. DYPN 103,40€

REMOTE CONTROL for thermostats DYP

10,8 x 5,3 x 2,3 cm



Art. TIR 41,00€

THERMOSTAT CIRCLE Wi-Fi  
up to 800 W  
heating elements



ø 6 x 8 x 5 cm



Chrome/Black finish  
Art. CIR-wifi 198,50€



TECHNICAL DATA p. 72  
ELECTRIC KIT DATA p. 208-209

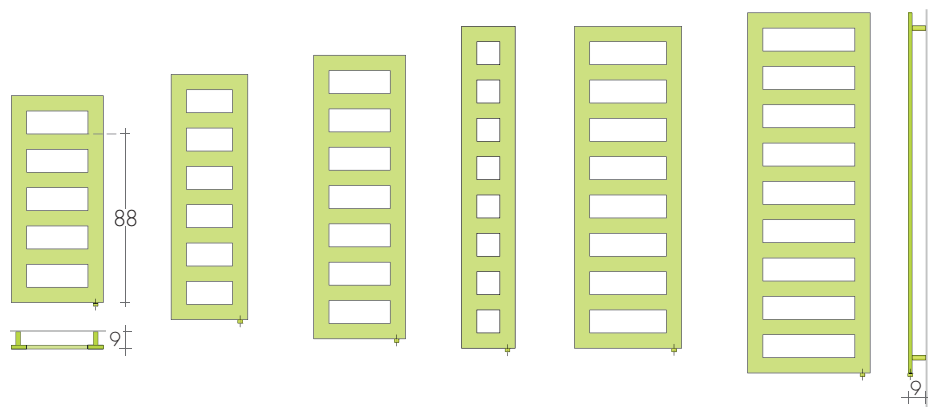

FIT 88-48  
FIT 108-48  
FIT 128-40  
FIT 128-56  
FIT 148-48  
FIT 168-28  
FIT 168-40  
FIT 168-56  
FIT 168-64  
FIT 188-56



HEATING ELEMENT POSITION  
© Vertical Heating Element



MODEL	H - L cm	Standard white	BREM Colors	BREM Colors	KIT HEATING ELEMENT with:		
		sablé SB 9016 €	+15% €	+25% €	Cable R..E Art. (W)	Faston R..T Art. (W)	€
FIT 88-48	88	704,30	809,90	880,40	R400IIE	R400IIT	195,70
FIT 108-48	108	747,90	860,10	934,90	R500IIE	R500IIT	208,50
FIT 128-40	128	777,70	894,40	972,10	R500IIE	R500IIT	208,50
FIT 128-56	128	877,90	1009,60	1097,40	R650IIE	R650IIT	222,90
FIT 148-48	148	904,40	1040,10	1130,50	R650IIE	R650IIT	222,90
FIT 168-28	168	909,40	1045,80	1136,80	R500IIE	R500IIT	208,50
FIT 168-40	168	940,60	1081,70	1175,80	R650IIE	R650IIT	222,90
FIT 168-56	168	1002,80	1153,20	1253,50	R800IIE	R800IIT	240,50
FIT 168-64	168	1017,00	1169,60	1271,30	R900IIE	R900IIT	255,30
FIT 188-56	188	1067,80	1228,00	1334,80	R900IIE	R900IIT	255,30

THERMOSTATS Wi-Fi FOR KIT RE P. 208

ACCESSORIES FOR

E.H.E. white cable cover  
or radiator color (together)  
Art.CCRE38 ø3/8" 73,40€  
Art.CCRE12 ø1/2" 73,40€



The KIT RT Wi-Fi includes:  
- Thermostat RT (battery)  
- Gateway  
- Built-in receiver

Art. KITRT-wifi 199,80€

Additional receiver  
(up to 6) radiators)



Art. SA868 64,20€

KIT ELY Wi-Fi TOP DESIGN includes:  
- Thermostat with magnetic charging base  
and magnetic plate for wall mounting  
- Gateway a 230V  
- Built-in Receiver

Art. KITELY-wifi 396,10€

Additional receiver: 1 for each electrical radiators  
or split AC (up to 16)



Art. SA600 99,10€



design Luigi Brembilla

TECHNICAL DATA p. 128  
ELECTRIC KIT DATA p. 208-209

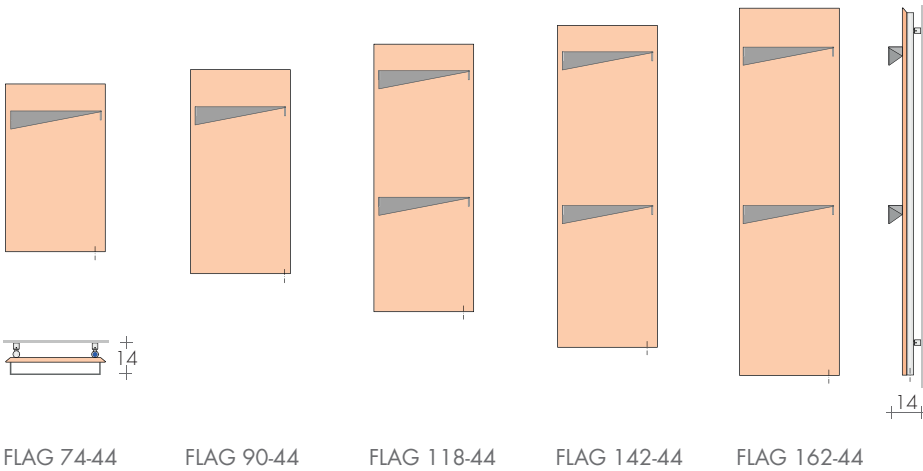

HEATING ELEMENT POSITION  
© Vertical Heating Element

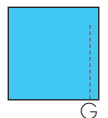

MODEL	H - L cm	Standard white	BREM Colors	BREM Colors	KIT HEATING ELEMENT with:		
		sablé SB 9016 €	+15% €	+25% €	Cable R..E Art. (W)	Faston R..T Art. (W)	€
FLAG	74-44	668,40	768,70	835,50	R400IIE	R400IIT	195,70
FLAG	90-44	744,80	856,50	931,00	R500IIE	R500IIT	208,50
FLAG	118-44	890,30	1023,80	1112,90	R650IIE	R650IIT	222,90
FLAG	142-44	964,40	1109,10	1205,50	R800IIE	R800IIT	240,50
FLAG	162-44	1026,60	1180,60	1283,30	R900IIE	R900IIT	255,30

TOWEL BAR FLAG: STANDARD COLORS  
- white sablé SB 9016 - quartz grey SB 7039  
- black sablé SB 9005 - same color as the radiator  
In one paintwork to Brem color list different from the radiator  
Extra Art.CM 52,90€

## ELECTRIC VERSIONS

## THERMOSTATS IN THE RADIATOR FOR KIT RT P. 209

THERMOSTAT mod. DYP



White with white cable cover  
Art. DYPB 89,60€

ø 7 x 9 x 5 cm



Black with black cable cover  
Art. DYPN 103,40€

REMOTE CONTROL for thermostats DYP

10,8 x 5,3 x 2,3 cm



Art. TIR 41,00€

THERMOSTAT CIRCLE Wi-Fi  
up to 800 W  
heating elements



ø 6 x 8 h x 5 cm



Chrome/Black finish  
Art. CIR-wifi 198,50€



TECHNICAL DATA and other dimensions page 174  
ELECTRIC KIT DATA page 208-209

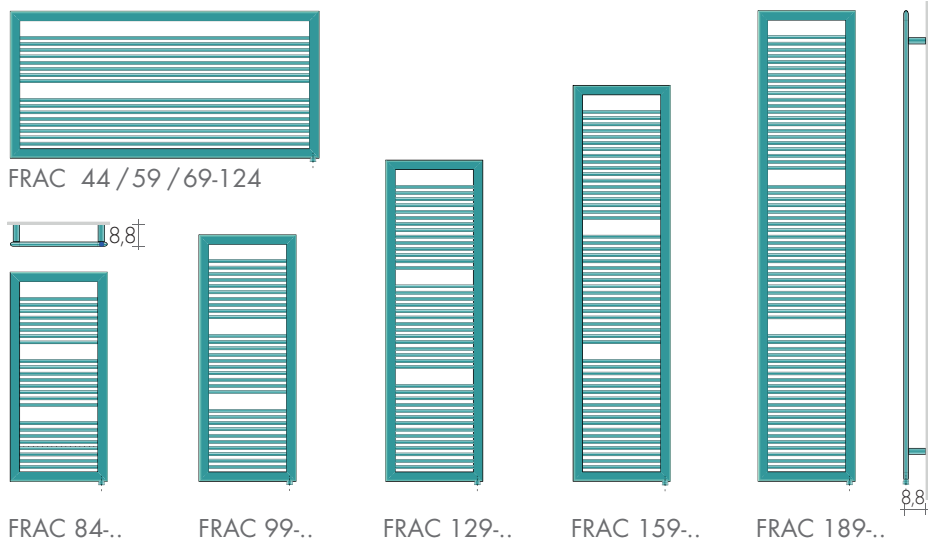

MODELE	H - L cm	Standard white	BREM Colors	BREM Colors	KIT HEATING ELEMENT with:		
		sablé SB 9016 €	+15% €	+25% €	Cable R.E Art. (W)	Faston R.T Art. (W)	€
FRAC 44-124	44-124	593,30	682,30	741,60	R500IIE	R500IIT	208,50
FRAC 59-124	59-124	709,50	815,90	886,90	R650IIE	R650IIT	222,90
FRAC 69-124	69-124	817,60	940,20	1022,00	R800IIE	R800IIT	240,50
FRAC 84-39	84-39	499,40	574,30	624,30	R300IIE	R300IIT	193,80
FRAC 84-49	84-49	518,20	595,90	647,80	R400IIE	R400IIT	195,70
FRAC 99-39	99-39	588,20	676,40	735,30	R400IIE	R400IIT	195,70
FRAC 99-49	99-49	608,90	700,20	761,10	R500IIE	R500IIT	208,50
FRAC 129-39	129-39	683,60	786,10	854,50	R500IIE	R500IIT	193,10
FRAC 129-49	129-49	704,60	810,30	880,80	R650IIE	R650IIT	206,40
FRAC 159-39	159-39	808,20	929,40	1010,30	R650IIE	R650IIT	222,90
FRAC 159-49	159-49	828,80	953,10	1036,00	R800IIE	R800IIT	240,50
FRAC 159-54	159-54	902,90	1038,30	1128,60	R900IIE	R900IIT	255,30
FRAC 189-39	189-39	937,00	1077,60	1171,30	R800IIE	R800IIT	240,50
FRAC 189-59	189-59	944,20	1085,80	1180,30	R1200IIE	R1200IIT	276,30

CHROME HOOK  
(ø 3 x 3,5 cm) p.277 Art. AC n°2 90,90€



HEATING ELEMENT POSITION  
© Vertical Heating Element

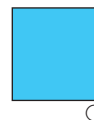

## THERMOSTATS Wi-Fi FOR KIT RE P. 208

## ACCESSORIES FOR

E.H.E. white cable cover  
or radiator color (together)  
Art.CCRE38 ø3/8" 73,40€  
Art.CCRE12 ø1/2" 73,40€



The KIT RT Wi-Fi includes:  
- Thermostat RT (battery)  
- Gateway  
- Built-in receiver

Art. KITRT-wifi 199,80€

Additional receiver  
(up to 6) radiators)



Art. SA868 64,20€

KIT ELY Wi-Fi TOP DESIGN includes:  
- Thermostat with magnetic charging base  
and magnetic plate for wall mounting  
- Gateway a 230V  
- Built-in Receiver

Art. KITELY-wifi 396,10€

Additional receiver: 1 for each electrical radiators  
or split AC (up to 16)



Art. SA600 99,10€

design Luigi Brembilla

TECHNICAL DATA  
and other dimensions page 74  
ELECTRIC KIT DATA page 208-209

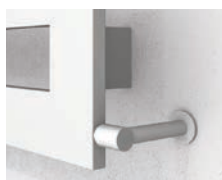
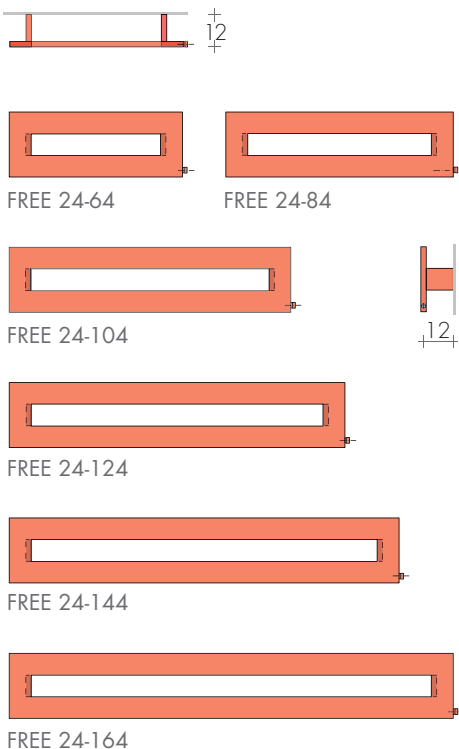

CABLE COVER FREE  
E.H.E. L = 12 cm  
Art. CCREF 89,60€

MODEL'25	H - L cm	Standard white sablé SB 9016 €	BREM Colors		KIT HEATING ELEMENT with		
			+15% €	+25% €	Cable R.E Art. (W)	Faston R.T Art. (W)	€
FREE	24-64	351,70	404,50	439,60	R250IIE	R250IIT	191,90
FREE	24-84	392,20	451,00	490,30	R250IIE	R250IIT	191,90
FREE	24-104	432,80	497,70	541,00	R300IIE	R300IIT	193,80
FREE	24-124	473,30	544,30	591,60	R300IIE	R300IIT	193,80
FREE	24-144	514,00	591,10	642,50	R400IIE	R400IIT	195,70
FREE	24-164	554,70	637,90	693,40	R500IIE	R500IIT	193,10



HEATING ELEMENT POSITION  
Ⓐ Horizontal Heating Element  
On request, Element in Ⓒ



## ELECTRIC VERSIONS

## THERMOSTATS IN THE RADIATOR FOR KIT RT P. 209

THERMOSTAT mod. DYP



White with  
white cable cover  
Art. DYPB 89,60€

ø 7 x 9 x 5 cm



Black with  
black cable cover  
Art. DYPN 103,40€

REMOTE CONTROL for thermostats DYP

10,8 x 5,3 x 2,3 cm



Art. TIR 41,00€

THERMOSTAT CIRCLE Wi-Fi  
up to 800 W  
heating elements



ø 6 x 8 h x 5 cm



Chrome/Black finish  
Art. CIR-wifi 198,50€



TECHNICAL DATA and other dimensions page 130  
ELECTRIC KIT DATA page 208-209

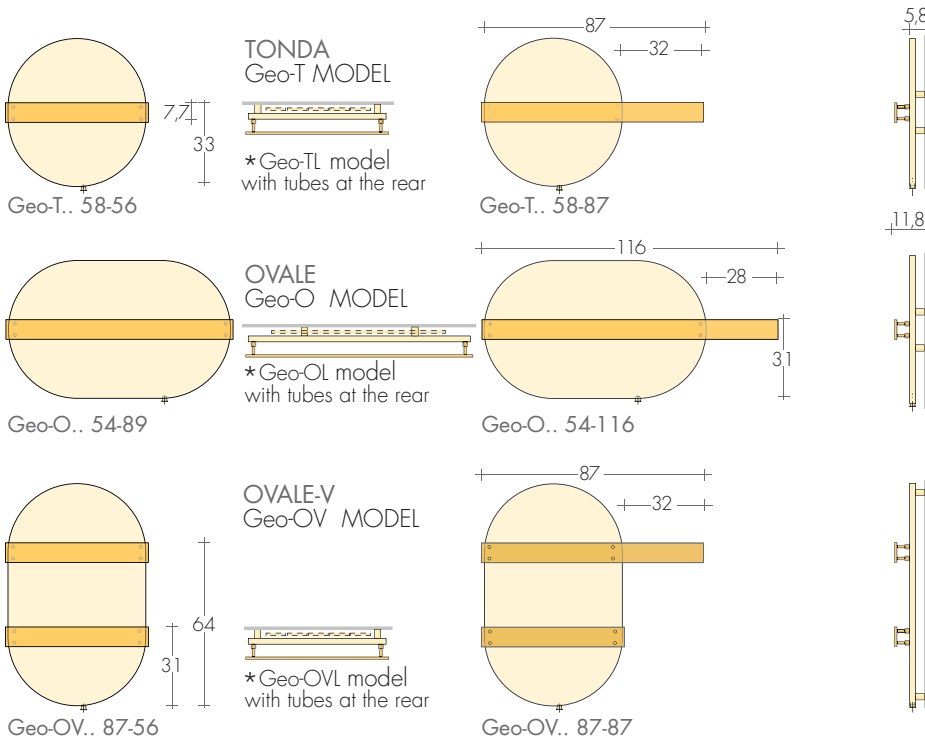

ON REQUEST, FREE OF CHARGE, TOWEL BAR WITH THE LEFT EXTENSION

MODEL	H - L cm	Standard white	BREM Colors	BREM Colors	KIT HEATING ELEMENT with:		
		sablé SB 9016 €	+15% €	+25% €	Cable R..E Art. (W)	Faston R..T Art. (W)	€
Geo-T	58-56	893,80	1027,90	1117,30	R300IIE	R300IIT	193,80
Geo-TL	58-56	1093,70	1257,80	1367,10	R500IIE	R500IIT	208,50
Geo-T	58-87	923,20	1061,70	1154,00	R400IIE	R400IIT	195,70
Geo-TL	58-87	1123,10	1291,60	1403,90	R500IIE	R500IIT	208,50
Geo-O	54-89	952,60	1095,50	1190,80	R500IIE	R500IIT	208,50
Geo-OL	54-89	1152,50	1325,40	1440,60	R800IIE	R800IIT	240,50
Geo-O	54-116	993,80	1142,90	1242,30	R500IIE	R500IIT	208,50
Geo-OL	54-116	1193,70	1372,80	1492,10	R800IIE	R800IIT	240,50
Geo-OV	87-56	1070,20	1230,70	1337,80	R500IIE	R500IIT	208,50
Geo-OVL	87-56	1270,10	1460,60	1587,60	R800IIE	R800IIT	240,50
Geo-OV	87-87	1099,60	1264,50	1374,50	R650IIE	R650IIT	222,90
Geo-OVL	87-87	1299,50	1494,40	1624,40	R800IIE	R800IIT	240,50

TOWEL BAR GEO: STANDARD COLORS  
 - white sablé SB 9016 - quartz grey SB 7039  
 - black sablé SB 9005 - same color as the radiator  
 In one paintwork to Brem color list different from the radiator  
 Extra Art.CM 52,90€

HEATING ELEMENT POSITION  
 ☉ Vertical Heating Element

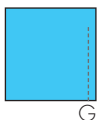

THERMOSTATS Wi-Fi FOR KIT RE P. 208

ACCESSORIES FOR



E.H.E. white cable cover  
or radiator color (together)  
Art.CCRE38 ø3/8" 73,40€  
Art.CCRE12 ø1/2" 73,40€

The KIT RT Wi-Fi includes:  
 - Thermostat RT (battery)  
 - Gateway  
 - Built-in receiver

Art. KITRT-wifi 199,80€

Additional receiver  
(up to 6) radiators)



Art. SA868 64,20€

KIT ELY Wi-Fi TOP DESIGN includes:  
 - Thermostat with magnetic charging base  
and magnetic plate for wall mounting  
 - Gateway a 230V  
 - Built-in Receiver

Art. KITELY-wifi 396,10€

Additional receiver: 1 for each electrical radiators  
or split AC (up to 16) Art. SA600 99,10€



TECHNICAL DATA and other dimensions page 132  
ELECTRIC KIT DATA page 208-209

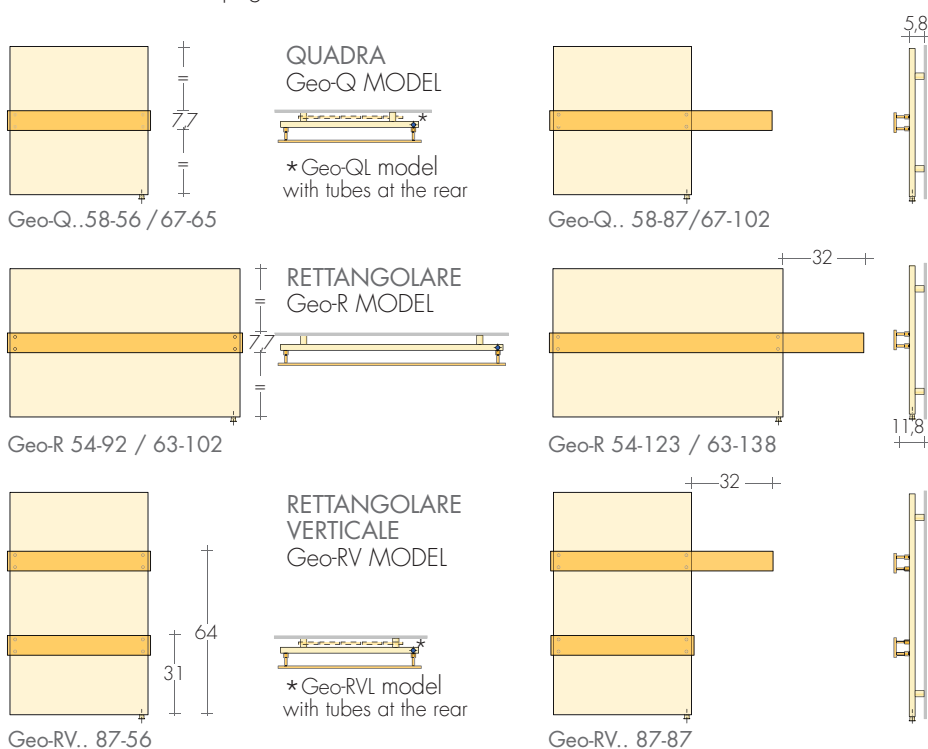

MODEL	H - L cm	Standard white sablé SB 9016 €	BREM Colors +15% €	BREM Colors +25% €	KIT HEATING ELEMENT with:		
					Cable R.E Art. (VV) €	Faston R.T Art. (VV) €	€
Geo-Q 58-56	58-56	946,70	1088,70	1183,40	R400IIE	R400IIT	195,70
Geo-QL 58-56	58-56	1146,70	1318,70	1433,40	R500IIE	R500IIT	208,50
Geo-Q 58-87	58-87	976,10	1122,50	1220,10	R400IIE	R400IIT	195,70
Geo-QL 58-87	58-87	1164,20	1338,80	1455,30	R500IIE	R500IIT	208,50
Geo-Q 67-65	67-65	1009,00	1160,40	1261,30	R500IIE	R500IIT	208,50
Geo-QL 67-65	67-65	1244,20	1430,80	1555,30	R650IIE	R650IIT	222,90
Geo-Q 67-102	67-102	1044,30	1200,90	1305,40	R650IIE	R650IIT	222,90
Geo-QL 67-102	67-102	1273,70	1464,80	1592,10	R800IIE	R800IIT	240,50
Geo-R 54-92	54-92	1039,60	1195,50	1299,50	R650IIE	R650IIT	222,90
Geo-R 54-123	54-123	1080,80	1242,90	1351,00	R650IIE	R650IIT	222,90
Geo-R 63-102	63-102	1186,00	1363,90	1482,50	R800IIE	R800IIT	240,50
Geo-R 63-138	63-138	1227,20	1411,30	1534,00	R900IIE	R900IIT	255,30
Geo-RV 87-56	87-56	1064,30	1223,90	1330,40	R650IIE	R650IIT	222,90
Geo-RVL 87-56	87-56	1264,30	1453,90	1580,40	R800IIE	R800IIT	240,50
Geo-RV 87-87	87-87	1093,70	1257,80	1367,10	R650IIE	R650IIT	222,90

TOWEL BAR GEO: STANDARD COLORS  
- white sablé SB 9016 - quartz grey SB 7039  
- black sablé SB 9005 - same color as the radiator  
In one paintwork to Brem color list different from the radiator  
Extra Art.CM 52,90€

ON REQUEST, BAR with DOUBLE PROJECTION

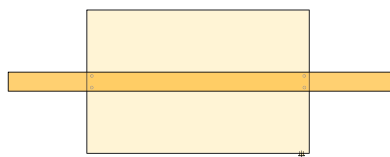

HEATING ELEMENT POSITION  
© Vertical Heating Element

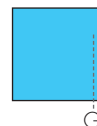

## ELECTRIC VERSIONS

## THERMOSTATS IN THE RADIATOR FOR KIT RT P. 209

THERMOSTAT mod. DYP



White with white cable cover  
Art. DYPB 89,60€

ø 7 x 9 x 5 cm



Black with black cable cover  
Art. DYPN 103,40€

REMOTE CONTROL for thermostats DYP

10,8 x 5,3 x 2,3 cm



Art. TIR 41,00€

THERMOSTAT CIRCLE Wi-Fi  
up to 800 W  
heating elements



ø 6 x 8 x 5 cm



Chrome/Black finish  
Art. CIR-wifi 198,50€



TECHNICAL DATA page 28  
ELECTRIC KIT DATA page 208

## FREESTANDING MODELS

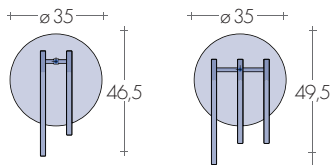

GUEST-A  
104-12

GUEST-A  
104-22



GUEST-A  
104-12

GUEST-A  
104-22

## SUSPENDED MODELS and MODELS WITH FEET

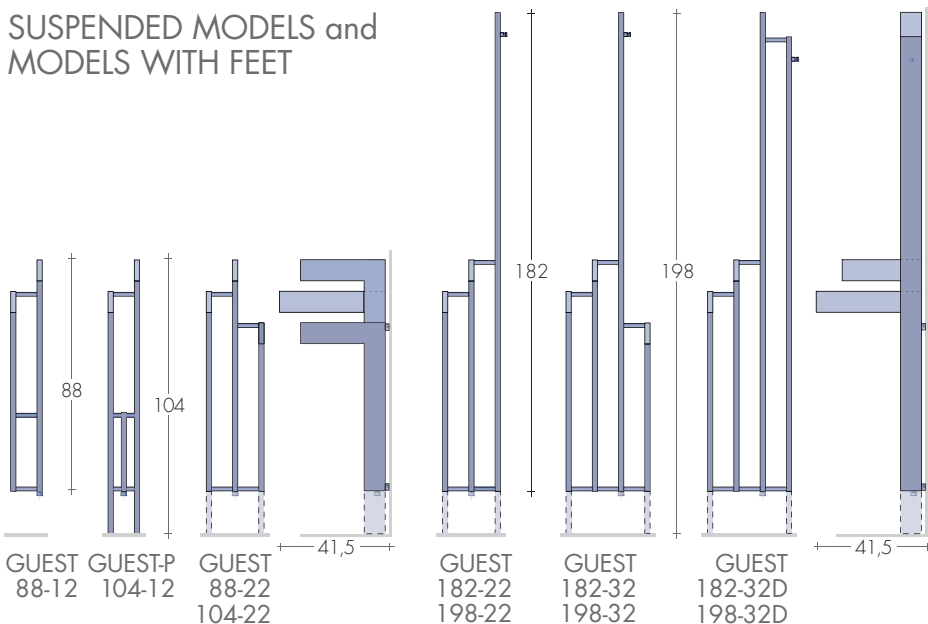

GUEST  
88-12

GUEST-P  
104-12

GUEST  
88-22

104-22

GUEST  
182-22

198-22

GUEST  
182-32

198-32

GUEST  
182-32D

198-32D

MODEL	H - L cm	Standard white	BREM Colors	BREM Colors	KIT HEATING ELEMENT with:		
		sablé SB 9016 €	+15% €	+25% €	Cable R.E Art. (W)	Faston R.T Art. (W)	€
GUEST	88-12	391,70	450,50	489,60	R250IIE	R250IIT	191,90
GUEST	88-22	526,40	605,40	658,00	R400IIE	R400IIT	195,70
GUEST	182-22	613,50	705,50	766,90	R500IIE	R500IIT	208,50
GUEST	182-32	695,00	799,30	868,80	R650IIE	R650IIT	222,90
GUEST	182-32D	753,40	866,40	941,80	R650IIE	R650IIT	222,90
MODELS WITH FEET							
GUEST	104-12	428,00	492,20	535,00	R300IIE	R300IIT	193,80
GUEST	104-22	562,70	647,10	703,40	R400IIE	R400IIT	195,70
GUEST	198-22	649,80	747,30	812,30	R500IIE	R500IIT	208,50
GUEST	198-32	731,20	840,90	914,00	R650IIE	R650IIT	222,90
GUEST	198-32D	789,70	908,20	987,10	R800IIE	R800IIT	240,50
FREESTANDING MODELS							
GUEST	104-12	498,50	573,30	623,10	R300IIE	R300IIT	193,80
GUEST	104-22	633,20	728,20	791,50	R400IIE	R400IIT	195,70



HEATING ELEMENT POSITION  
© Vertical Heating Element

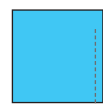

G

## THERMOSTATS Wi-Fi FOR KIT RE P. 208

## ACCESSORIES FOR

White cable cover or radiator color (Painted together) for E.H.E.)

Art.CCRE38 ø 3/8" 73,40€  
Art.CCRE12 ø 1/2" 73,40€



The KIT RT Wi-Fi includes:  
- Thermostat RT (battery)  
- Gateway  
- Built-in receiver

Art. KITRT-wifi 199,80€

Additional receiver  
(up to 6) radiators)

Art. SA868 64,20€



KIT ELY Wi-Fi TOP DESIGN includes:  
- Thermostat with magnetic charging base and magnetic plate for wall mounting  
- Gateway a 230V  
- Built-in Receiver

Art. KITELY-wifi 396,10€

Additional receiver: 1 for each electrical radiators or split AC (up to 16) Art. SA600 99,10€



design Luigi Brembilla

Electric heated towel rail for bathroom towels available in two sizes: 55 and 123 cm; powered by electrical supply 24VDC.

Hand can be installed horizontally or vertically, left or right, high or low connection, to allow free compositions.

## DIMENSIONS

Lengths: 7,7 / 55 / 123 cm  
 Heights: 7,7 / 55 / 123 cm  
 Depth / Depth from wall: 7 cm



HAND 8 - 55

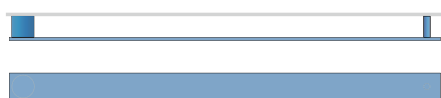

HAND 8 - 123

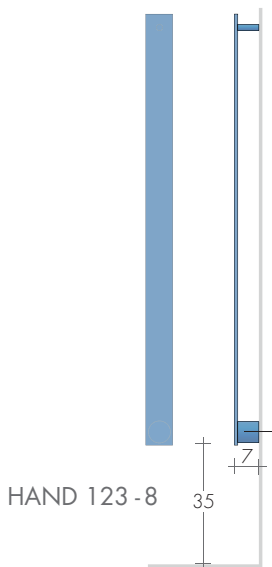

HAND 123 - 8



SPECIAL GALVANIC FINISHES on request

- GOLD
- BRONZE
- NICKEL BRUSHED
- BLACK NICKEL



MODEL	PRICES INCLUDE THE ELECTRIC ELEMENT, 24VDC				Heating ELEMENT 24VDC - Class III THERMAL OUTPUT /Consumption
	Standard white H - L cm	sablé SB 9016 €	BREM Colors +15% €	BREM Colors +25% €	
HAND 8 - 55		526,40	605,40	658,00	30 W
HAND 8 - 123		694,40	798,60	868,00	75 W
HAND 55 - 8		526,40	605,40	658,00	30 W
HAND 123 - 8		694,40	798,60	868,00	75 W

HAND: suitable for bathrobes  
 Art. HB 44,20€

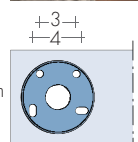
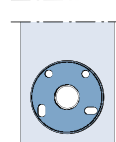

FIXINGS included

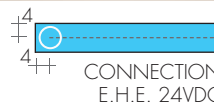

Prepare 24vDC CONTROLLED LIGHT POINT with SELV POWER SUPPLY

## ELECTRIC VERSIONS

THERMOSTATS IN THE RADIATOR FOR KIT RT P. 209 DO NOT USE with HAND

THERMOSTAT mod. DYP



White with white cable cover  
 Art. DYPB 89,60€

ø 7 x 9 x 5 cm



Black with black cable cover  
 Art. DYPN 103,40€

REMOTE CONTROL for thermostats DYP

10,8 x 5,3 x 2,3 cm



Art. TIR 41,00€

THERMOSTAT CIRCLE Wi-Fi  
 up to 800 W  
 heating elements



ø 6 x 8 x 5 cm



Chrome/Black finish  
 Art. CIR-wifi 198,50€



design Luigi Brebbilla

TECHNICAL DATA and other dimensions p. 30  
ELECTRIC KIT DATA p. 208-209

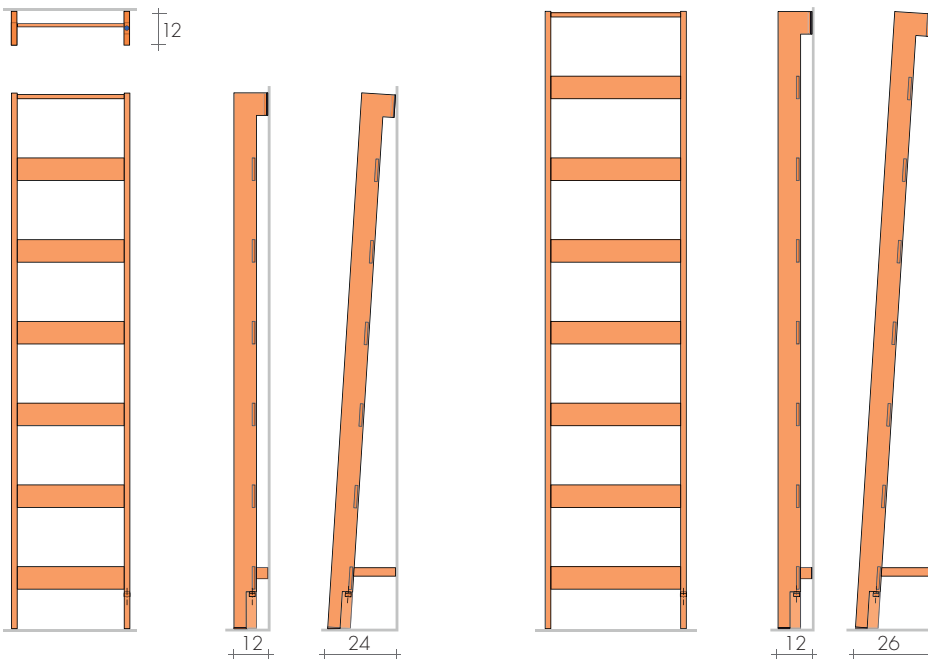

HERG-ÖT 185-42

HERG-ÖT 212-50 ..58



MODEL	H - L cm	Standard white sablé SB 9016 €	BREM Colors +15% €	BREM Colors +25% €	KIT HEATING ELEMENT with:		
					Cable R.E Art. (W)	Faston R.T Art. (W)	€
HERG-ÖT 185-42	185-42	995,20	1144,50	1244,00	R650IIE	-	222,90
HERG-ÖT 185-50	185-50	1163,20	1337,70	1454,00	R800IIE	-	240,50
HERG-ÖT 185-58	185-58	1204,20	1384,80	1505,30	R900IIE	-	255,30
Angled HERG-ÖT, extra Art. HOI			108,80€	ONLY with Wi-Fi THERMOSTATS for KIT RE			

HEATING ELEMENT POSITION  
© Vertical Heating Element

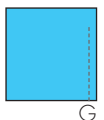

## THERMOSTATS Wi-Fi FOR KIT RE P. 208

## ACCESSORIES FOR

E.H.E. white cable cover  
or radiator color (together)  
Art.CCRE38 ø3/8" 73,40€  
Art.CCRE12 ø1/2" 73,40€



The KIT RT Wi-Fi includes:  
- Thermostat RT (battery)  
- Gateway  
- Built-in receiver

Art. KITRT-wifi 199,80€

Additional receiver  
(up to 6) radiators)

Art. SA868 64,20€



KIT ELY Wi-Fi TOP DESIGN includes:  
- Thermostat with magnetic charging base  
and magnetic plate for wall mounting  
- Gateway a 230V  
- Built-in Receiver

Art. KITELY-wifi 396,10€

Additional receiver: 1 for each electrical radiators  
or split AC (up to 16) Art. SA600 99,10€



TECHNICAL DATA

HERG RADIATORS page 14  
 HERG'S TOWEL-HEATERS page 32  
 On request other dimensions  
 ELECTRIC KIT DATA page 208-209

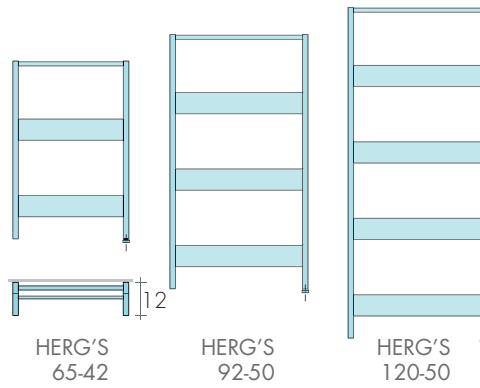

HERG HGS

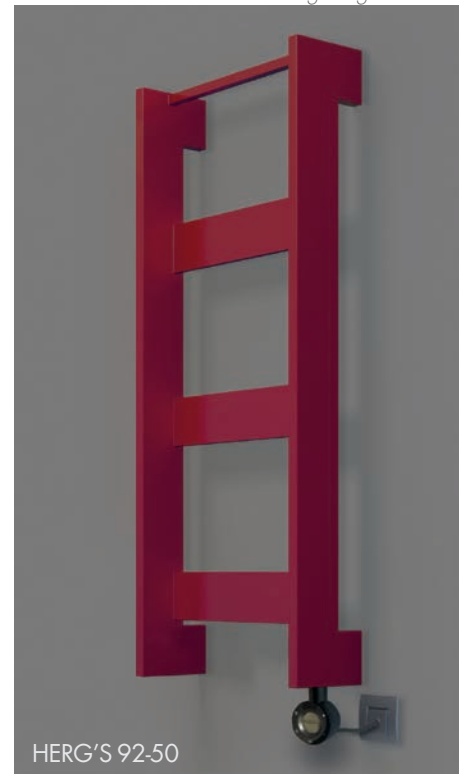
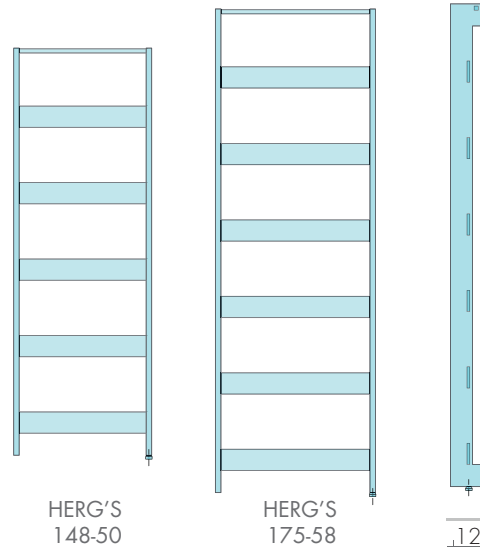
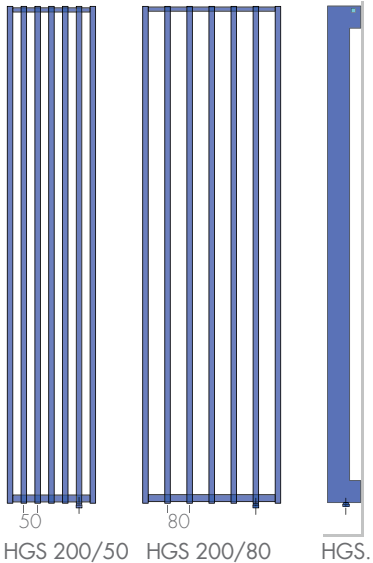

MODEL	H - L cm	Standard white sablé SB 9016 €	BREM Colors		KIT HEATING ELEMENT with:		
			+15% €	+25% €	Cable R.E Art. (W)	Faston R.T Art. (W)	€
Towelheaters							
HERG'S 65-42		533,80	613,90	667,30	R250IIE	R250IIT	191,90
HERG'S 92-50		642,40	738,80	803,00	R400IIE	R400IIT	195,70
HERG'S 120-50		786,40	904,40	983,00	R500IIE	R500IIT	208,50
HERG'S 148-50		895,10	1029,40	1118,90	R650IIE	R650IIT	222,90
HERG'S 175-58		1031,40	1186,10	1289,30	R800IIE	R800IIT	240,50
Radiators							
Hcm/PE -n°el. L cm							
HGS 180/80-5el 34		976,60	1123,10	1220,80	R900IIE	R900IIT	255,30
HGS 200/50-5el 22		1016,00	1168,40	1270,00	R800IIE	R800IIT	240,50
HGS 200/80-5el 34		1016,00	1168,40	1270,00	R900IIE	R900IIT	255,30
HGS 200/80-6el 42		1145,40	1317,20	1431,80	R1200IIE	R1200IIT	276,30
HGS 200/50-7el 32		1275,10	1466,40	1593,90	R1200IIE	R1200IIT	276,30
HGS 200/80-8el 58		1404,70	1615,40	1755,90	R1500IIE	R1500IIT	298,00
HGS 200/50-9el 42		1534,40	1764,60	1918,00	R1500IIE	R1500IIT	298,00

PE = step (distance between the midpoints of 2 elements)

HEATING ELEMENT POSITION  
 © Vertical Heating Element

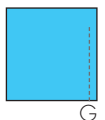

ELECTRIC VERSIONS

THERMOSTATS IN THE RADIATOR FOR KIT RT P. 209

THERMOSTAT mod. DYP



White with white cable cover  
 Art. DYPB 89,60€

ø 7 x 9 x 5 cm



Black with black cable cover  
 Art. DYPN 103,40€

REMOTE CONTROL for thermostats DYP

10,8 x 5,3 x 2,3 cm



Art. TIR 41,00€

THERMOSTAT CIRCLE Wi-Fi  
 up to 800 W heating elements



ø 6 x 8 x 5 cm



Chrome/Black finish  
 Art. CIR-wifi 198,50€



design Luigi Brembilla

TECHNICAL DATA and other dimensions p.34  
ELECTRIC KIT DATA p. 208-209

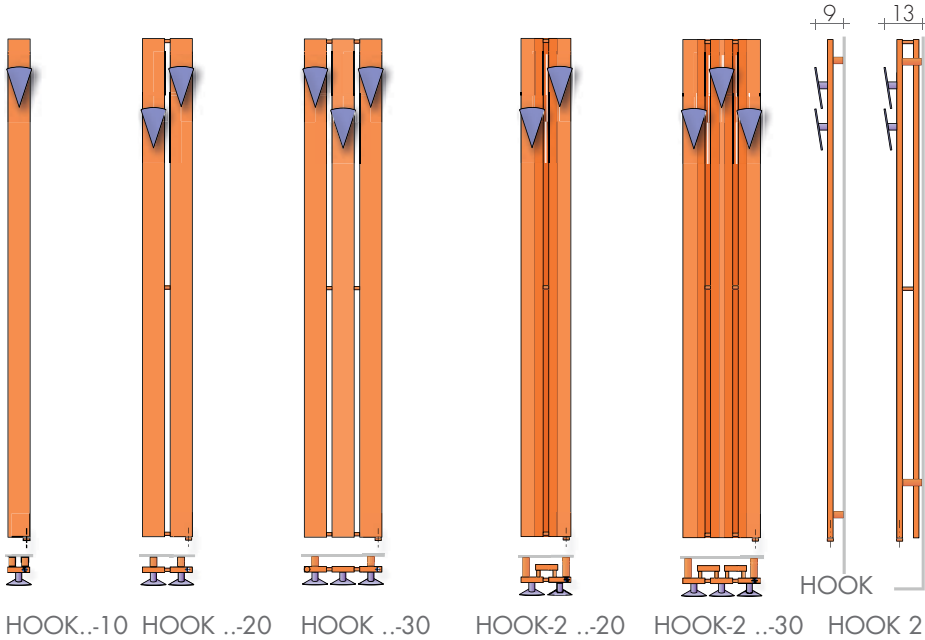

MODEL	H - L cm	Standard white	BREM Colors		KIT HEATING ELEMENT with:		
		sablé SB 9016 €	+15% €	+25% €	Cable R..E Art. (W)	Faston R..T Art. (W)	€
HOOK	180-20	771,80	887,60	964,80	R400IIE	R400IIT	195,70
HOOK	180-30	981,70	1129,00	1227,10	R500IIE	R500IIT	208,50
HOOK	210-10	580,80	667,90	726,00	R250IIE	R250IIT	191,90
HOOK	210-20	790,60	909,20	988,30	R400IIE	R400IIT	195,70
HOOK	210-30	1000,20	1150,20	1250,30	R650IIE	R650IIT	222,90
HOOK-2	180-20	971,80	1117,60	1214,80	R500IIE	R500IIT	208,50
HOOK-2	180-30	996,80	1146,30	1246,00	R650IIE	R650IIT	222,90
HOOK-2	210-20	1156,50	1330,00	1445,60	R650IIE	R650IIT	222,90
HOOK-2	210-30	1181,20	1358,40	1476,50	R900IIE	R900IIT	255,30

KNOB mod. HK: STANDARD COLORS  
- white sablé SB 9016 - quartz grey SB 7039  
- black sablé SB 9005 - same color as the radiator  
In one paintwork to Brem color list different from the radiator  
Extra Art. CM 52,90€

KNOB, on demand without extra

Mod. PO



Mod. ARO



HEATING ELEMENT POSITION  
© Vertical Heating Element

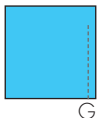

## THERMOSTATS Wi-Fi FOR KIT RE P. 208

## ACCESSORIES FOR

E.H.E. white cable cover  
or radiator color (together)  
Art.CCRE38 ø3/8" 73,40€  
Art.CCRE12 ø1/2" 73,40€



The KIT RT Wi-Fi includes:  
- Thermostat RT (battery)  
- Gateway  
- Built-in receiver

Art. KITRT-wifi 199,80€

Additional receiver  
(up to 6) radiators)

Art. SA868 64,20€



KIT ELY Wi-Fi TOP DESIGN includes:  
- Thermostat with magnetic charging base  
and magnetic plate for wall mounting  
- Gateway a 230V  
- Built-in Receiver

Art. KITELY-wifi 396,10€

Additional receiver: 1 for each electrical radiators  
or split AC (up to 16) Art. SA600 99,10€



design Luigi Brembilla

TECHNICAL DATA and other dimensions p.76  
ELECTRIC KIT DATA p. 208-209

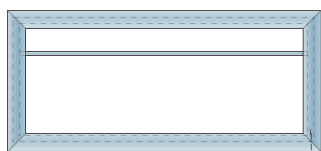

KORE-P 55-124

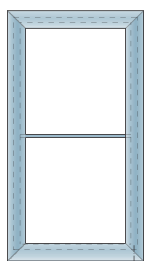

KORE-P 98-54

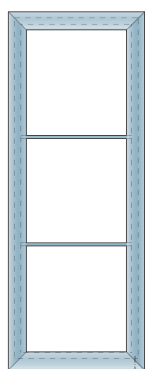

KORE-P 140-54

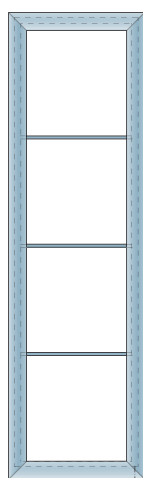

KORE-P 180-54



MODEL	H - L cm	Standard white	BREM Colors	BREM Colors	KIT HEATING ELEMENT with:		
		sablé SB 9016 €	+15% €	+25% €	Cable R..E Art. (W)	Faston R..T Art. (W)	€
KORE-P	55-124	658,80	757,60	823,50	R500IIE	R500IIT	208,50
KORE-P	98-54	567,70	652,90	709,60	R400IIE	R400IIT	195,70
KORE-P	140-54	687,10	790,20	858,90	R500IIE	R500IIT	208,50
KORE-P	180-54	738,90	849,70	923,60	R650IIE	R650IIT	222,90

HEATING ELEMENT POSITION  
© Vertical Heating Element



G

## ELECTRIC VERSIONS

## THERMOSTATS IN THE RADIATOR FOR KIT RT P. 209

THERMOSTAT mod. DYP



White with  
white cable cover  
Art. DYPB 89,60€

ø 7 x 9 x 5 cm



Black with  
black cable cover  
Art. DYPN 103,40€

REMOTE CONTROL for thermostats DYP

10,8 x 5,3 x 2,3 cm



Art. TIR 41,00€

THERMOSTAT CIRCLE Wi-Fi  
up to 800 W  
heating elements



ø 6 x 8 x 5 cm



Chrome/Black finish  
Art. CIR-wifi 198,50€



TECHNICAL DATA and other dimensions p. 176  
ELECTRIC KIT DATA p. 208-209

e.KUAD has squared manifolds at front as standard.  
State if the manifolds front side are curved

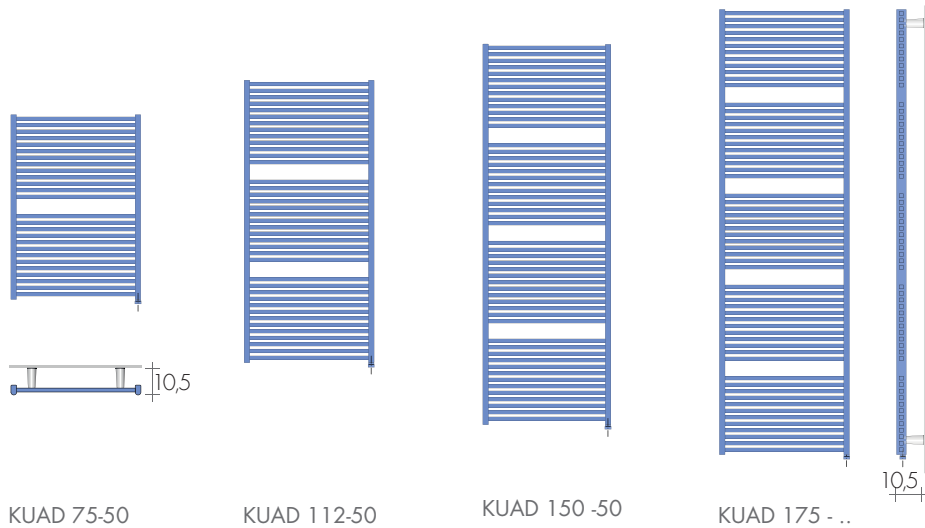

MODEL	H - L cm	Standard white sablé SB 9016 €	BREM Colors		KIT HEATING ELEMENT with:		
			+15% €	+25% €	Cable R..E Art. (W)	Faston R..T Art. (W)	€
KUAD	75-50	420,30	483,30	525,40	R400IIE	R400IIT	195,70
KUAD	112-50	627,20	721,30	784,00	R650IIE	R650IIT	222,90
KUAD	150-50	780,90	898,00	976,10	R800IIE	R800IIT	240,50
KUAD Slim	175-35	849,00	976,40	1061,30	R650IIE	R650IIT	222,90
KUAD	175-50	889,60	1023,00	1112,00	R900IIE	R900IIT	255,30

Towel heaters height = H - 4 cm (71-108,5-146-171cm)

HEATING ELEMENT POSITION  
© Vertical Heating Element

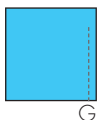

## THERMOSTATS Wi-Fi FOR KIT RE P. 208

## ACCESSORIES FOR

E.H.E. white cable cover  
or radiator color (together)  
Art.CCRE38 ø3/8" 73,40€  
Art.CCRE12 ø1/2" 73,40€



The KIT RT Wi-Fi includes:  
- Thermostat RT (battery)  
- Gateway  
- Built-in receiver

Art. KITRT-wifi 199,80€

Additional receiver  
(up to 6) radiators)

Art. SA868 64,20€



KIT ELY Wi-Fi TOP DESIGN includes:  
- Thermostat with magnetic charging base  
and magnetic plate for wall mounting  
- Gateway a 230V  
- Built-in Receiver

Art. KITELY-wifi 396,10€

Additional receiver: 1 for each electrical radiators  
or split AC (up to 16) Art. SA600 99,10€



design Davide Brembilla

TECHNICAL DATA and other dimensions p. 36  
ELECTRIC KIT DATA p. 208-209

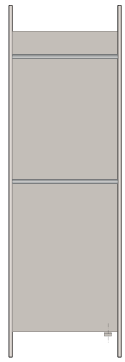
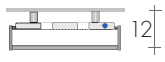

KUO 110..

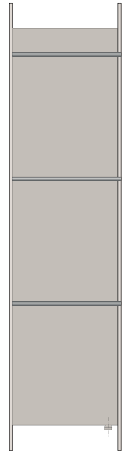

KUO 140..

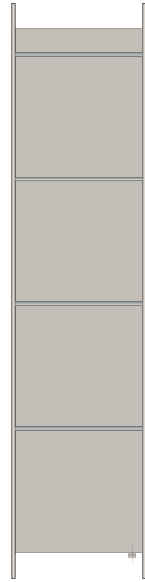

KUO 180..

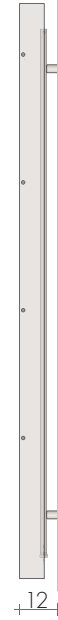

MODEL	H - L cm	Standard white	BREM Colors	BREM Colors	KIT HEATING ELEMENT with:		
		sablé SB 9016 €	+15% €	+25% €	Cable R.E Art. (W)	Faston R.T Art. (W)	€
KUO	110-25	591,00	679,70	738,80	R400IIE	R400IIT	195,70
KUO	110-35	664,70	764,40	830,90	R500IIE	R500IIT	208,50
KUO	140-25	676,30	777,70	845,40	R500IIE	R500IIT	208,50
KUO	140-35	775,30	891,60	969,10	R650IIE	R650IIT	222,90
KUO	140-42	918,30	1056,00	1147,90	R800IIE	R800IIT	240,50
KUO	180-25	845,80	972,70	1057,30	R650IIE	R650IIT	222,90
KUO	180-35	1013,40	1165,40	1266,80	R900IIE	R900IIT	255,30
KUO	180-42	1054,30	1212,40	1317,90	R1200IIE	R1200IIT	276,30

HEATING ELEMENT POSITION  
© Vertical Heating Element

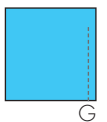

## ELECTRIC VERSIONS

THERMOSTATS IN THE RADIATOR FOR KIT RT P. 209

THERMOSTAT mod. DYP



White with white cable cover  
Art. DYPB 89,60€

ø 7 x 9 x 5 cm



Black with black cable cover  
Art. DYPN 103,40€

REMOTE CONTROL for thermostats DYP

10,8 x 5,3 x 2,3 cm



Art. TIR 41,00€

THERMOSTAT CIRCLE Wi-Fi  
up to 800 W  
heating elements



ø 6 x 8 x 5 cm



Chrome/Black finish  
Art. CIR-wifi 198,50€



design Davide Brembilla

TECHNICAL DATA and other dimensions p. 38  
ELECTRIC KIT DATA p. 208-209

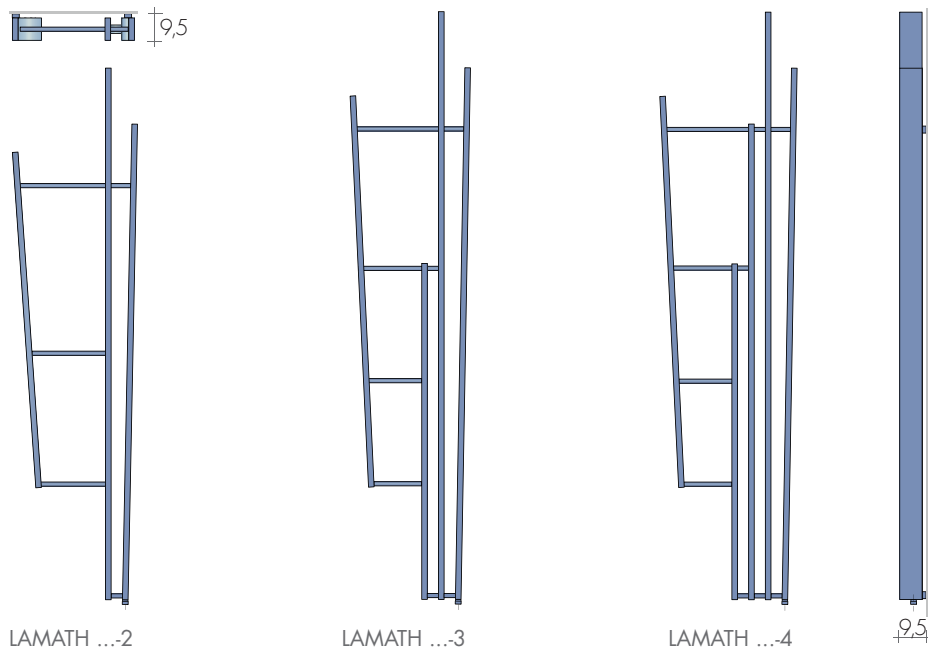

MODEL	H - n° cm-el	Standard white sablé SB 9016 €	BREM Colors		KIT HEATING ELEMENT with:		
			+15% €	+25% €	Cable R.E Art. (W)	Faston R.T Art. (W)	€
LAMATH	190-2	723,40	831,90	904,30	R400IIE	R400IIT	195,70
LAMATH	190-3	857,40	986,00	1071,80	R500IIE	R500IIT	208,50
LAMATH	190-4	991,90	1140,70	1239,90	R650IIE	R650IIT	222,90
LAMATH	210-2	774,60	890,80	968,30	R500IIE	R500IIT	208,50
LAMATH	210-3	927,10	1066,20	1158,90	R650IIE	R650IIT	222,90
LAMATH	210-4	1079,60	1241,50	1349,50	R800IIE	R800IIT	240,50

HEATING ELEMENT POSITION  
© Vertical Heating Element



G

## THERMOSTATS Wi-Fi FOR KIT RE P. 208

## ACCESSORIES FOR

E.H.E. white cable cover  
or radiator color (together)  
Art.CCRE38 ø3/8" 73,40€  
Art.CCRE12 ø1/2" 73,40€



The KIT RT Wi-Fi includes:  
- Thermostat RT (battery)  
- Gateway  
- Built-in receiver

Art. KITRT-wifi 199,80€

Additional receiver  
(up to 6) radiators)



Art. SA868 64,20€

KIT ELY Wi-Fi TOP DESIGN includes:  
- Thermostat with magnetic charging base  
and magnetic plate for wall mounting  
- Gateway a 230V  
- Built-in Receiver

Art. KITELY-wifi 396,10€

Additional receiver: 1 for each electrical radiators  
or split AC (up to 16)



Art. SA600 99,10€



TECHNICAL DATA and other dimensions p. 10  
ELECTRIC KIT DATA p. 208-209

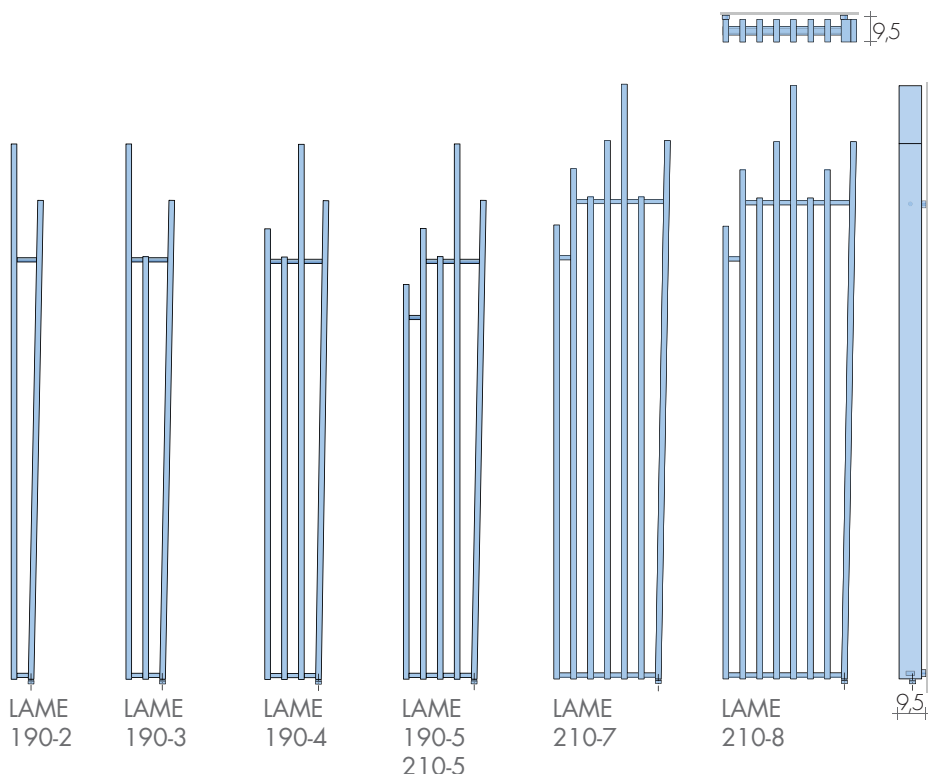

MODEL	H - n° cm-el	L cm	Standard white	BREM Colors	BREM Colors	KIT HEATING ELEMENT with:		
			sablé SB 9016 €	+15% €	+25% €	Cable R.E Art. (W)	Faston R.T Art. (W)	€
LAME 190-2	11	11	625,00	718,80	781,30	R400IIE	R400IIT	195,70
LAME 190-3	17	17	768,40	883,70	960,50	R500IIE	R500IIT	208,50
LAME 190-4	23	23	911,80	1048,60	1139,80	R650IIE	R650IIT	222,90
LAME 190-5	29	29	1055,30	1213,60	1319,10	R800IIE	R800IIT	240,50
LAME 190-6	35	35	1198,50	1378,30	1498,10	R900IIE	R900IIT	255,30
LAME 210-5	29	29	1148,60	1320,90	1435,80	R900IIE	R900IIT	255,30
LAME 210-7	41	41	1472,60	1693,50	1840,80	R1200IIE	R1200IIT	276,30
LAME 210-8	47	47	1634,80	1880,00	2043,50	R1500IIE	R1500IIT	298,00

HEATING ELEMENT POSITION  
© Vertical Heating Element



## ELECTRIC VERSIONS

THERMOSTATS IN THE RADIATOR FOR KIT RT P. 209

THERMOSTAT mod. DYP



White with  
white cable cover  
Art. DYPB 89,60€

ø 7 x 9 x 5 cm



Black with  
black cable cover  
Art. DYPN 103,40€

REMOTE CONTROL for thermostats DYP

10,8 x 5,3 x 2,3 cm



Art. TIR 41,00€

THERMOSTAT CIRCLE Wi-Fi  
up to 800 W  
heating elements



ø 6 x 8 x 5 cm



Chrome/Black finish  
Art. CIR-wifi 198,50€



# e.LAME SLIM

PRICE FROM 01.03.2026 +5%

design Davide Brembilla

TECHNICAL DATA and other dimensions p. 40  
ELECTRIC KIT DATA p. 208-209

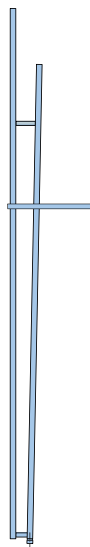

LAME Slim 190/2

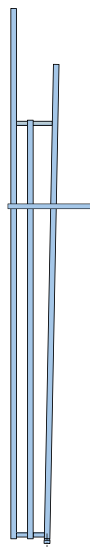

LAME Slim .../3

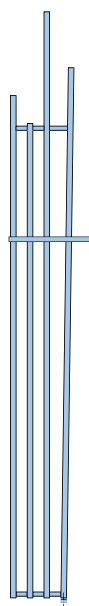

LAME Slim ..../4

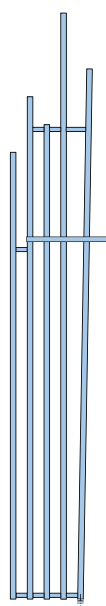

LAME Slim 210/5

15,7



MODEL	H-n° cm-el	L cm	Standard white	BREM Colors	BREM Colors	KIT HEATING ELEMENT with:		
			sablé SB 9016 €	+15% €	+25% €	Cable R.E Art. (VV)	Faston R.T Art. (VV)	€
LAME SLIM 190/2	11		713,10	820,10	891,40	R400IIE	R400IIT	181,20
LAME SLIM 190/3	17		856,60	985,10	1070,80	R500IIE	R500IIT	193,10
LAME SLIM 190/4	23		999,80	1149,80	1249,80	R650IIE	R650IIT	206,40
LAME SLIM 210/3	17		918,70	1056,50	1148,40	R500IIE	R500IIT	208,50
LAME SLIM 210/4	23		1081,70	1244,00	1352,10	R800IIE	R800IIT	240,50
LAME SLIM 210/5	29		1259,30	1448,20	1574,10	R900IIE	R900IIT	255,30

Width with towel bar 30 cm, and 36 cm for mod 210/5



HEATING ELEMENT POSITION  
© Vertical Heating Element



G

## THERMOSTATS IN THE RADIATOR FOR KIT RT P.209 ACCESSORIES FOR

THERMOSTAT mod. DYP



White with white cable cover  
Art. DYPB 89,60€

ø 7 x 9 x 5 cm



Black with black cable cover  
Art. DYPN 103,40€

REMOTE CONTROL for thermostats DYP

10,8 x 5,3 x 2,3 cm



Art. TIR 41,00€

THERMOSTAT CIRCLE Wi-Fi  
up to 800 W  
heating elements



ø 6 x 8 x 5 cm



Chrome/Black finish  
Art. CIR-wifi 198,50€



design Davide Brembilla

TECHNICAL DATA and other dimensions p. 12  
ELECTRIC KIT DATA p. 208-209

Standard position on the short side  
On request: position on the long side

Extra Art. LAME-UPL 72,50€

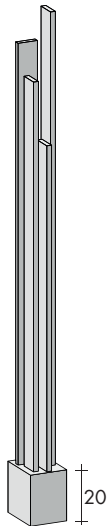
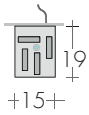

LAME-UP  
200-4

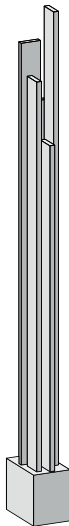

LAME-UP  
200-5

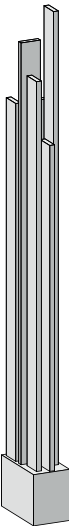
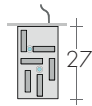

LAME-UP  
200-6

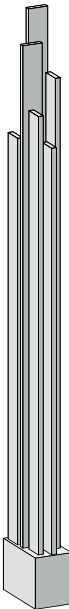
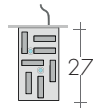

LAME-UP  
230-6

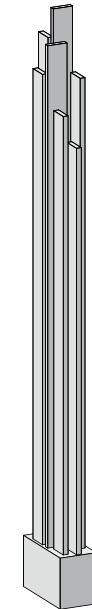
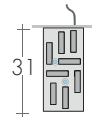

LAME-UP  
200-8  
230-8

MODEL	H - L cm	Standard white sablé SB 9016 €	BREM Colors +15% €	BREM Colors +25% €	KIT HEATING ELEMENT with:		
					Cable R.E Art. (W)	Faston R.T Art. (W)	€
LAME-UP 200-4	200-4	1032,60	1187,50	1290,80	R650IIE	-	222,90
LAME-UP 200-5	200-5	1279,00	1470,90	1598,80	R800IIE	-	240,50
LAME-UP 200-6	200-6	1449,80	1667,30	1812,30	R900IIE	-	255,30
LAME-UP 200-8	200-8	1862,70	2142,10	2328,40	R1200IIE	-	276,30
LAME-UP 230-6	230-6	1572,40	1808,30	1965,50	R1200IIE	-	276,30
LAME-UP 230-8	230-8	2010,00	2311,50	2512,50	R1500IIE	-	298,00
led light page 12   n.1	Art. F.LED1	65,00€	ONLY with Wi-Fi THERMOSTATS for KIT RE				
n.2	Art. F.LED2	108,20€					



HEATING ELEMENT POSITION  
© Vertical Heating Element



## ELECTRIC VERSIONS

## THERMOSTATS Wi-Fi FOR KIT RE P. 208

E.H.E. white cable cover  
or radiator color (together)  
Art.CCRE38 ø3/8" 73,40€  
Art.CCRE12 ø1/2" 73,40€



The KIT RT Wi-Fi includes:  
- Thermostat RT (battery)  
- Gateway  
- Built-in receiver

Art. KITRT-wifi 199,80€

Additional receiver  
(up to 6) radiators)

Art. SA868 64,20€



KIT ELY Wi-Fi TOP DESIGN includes:  
- Thermostat with magnetic charging base  
and magnetic plate for wall mounting  
- Gateway a 230V  
- Built-in Receiver

Art. KITELY-wifi 396,10€

Additional receiver: 1 for each electrical radiators  
or split AC (up to 16) Art. SA600 99,10€



ELECTRIC

TECHNICAL DATA and other dimensions p. 178  
ELECTRIC KIT DATA p. 208-209

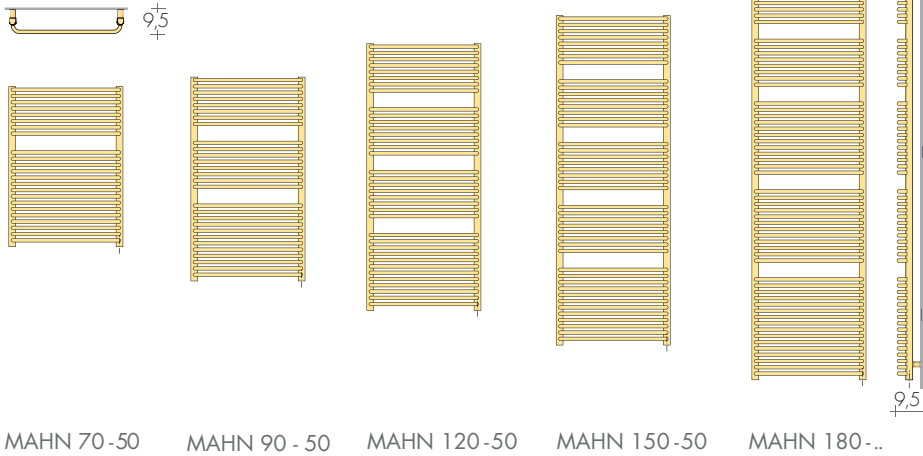

HEATING ELEMENT POSITION  
© Vertical Heating Element

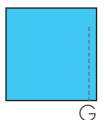

MODEL	H - L cm	Standard white	BREM Colors	BREM Colors	KIT HEATING ELEMENT with:		
		sablé SB 9016 €	+15% €	+25% €	Cable R.E Art. (W)	Faston R.T Art. (W)	€
MAHN	70-50	584,00	671,60	730,00	R400IIE	R400IIT	195,70
MAHN	90-50	742,70	854,10	928,40	R500IIE	R500IIT	208,50
MAHN	120-50	883,60	1016,10	1104,50	R650IIE	R650IIT	222,90
MAHN	150-50	1047,30	1204,40	1309,10	R800IIE	R800IIT	240,50
Slim-MAHN	180-28	1135,30	1305,60	1419,10	R650IIE	R650IIT	222,90
MAHN	180-60	1302,20	1497,50	1627,80	R1200IIE	R1200IIT	276,30

THERMOSTATS Wi-Fi FOR KIT RE P. 208

ACCESSORIES FOR

E.H.E. white cable cover  
or radiator color (together)  
Art.CCRE38 ø3/8" 73,40€  
Art.CCRE12 ø1/2" 73,40€



The KIT RT Wi-Fi includes:  
- Thermostat RT (battery)  
- Gateway  
- Built-in receiver

Art. KITRT-wifi 199,80€

Additional receiver  
(up to 6) radiators)



Art. SA868 64,20€

KIT ELY Wi-Fi TOP DESIGN includes:  
- Thermostat with magnetic charging base  
and magnetic plate for wall mounting  
- Gateway a 230V  
- Built-in Receiver

Art. KITELY-wifi 396,10€

Additional receiver: 1 for each electrical radiators  
or split AC (up to 16) Art. SA600 99,10€



TECHNICAL DATA and other dimensions p. 180  
ELECTRIC KIT DATA p. 208-209

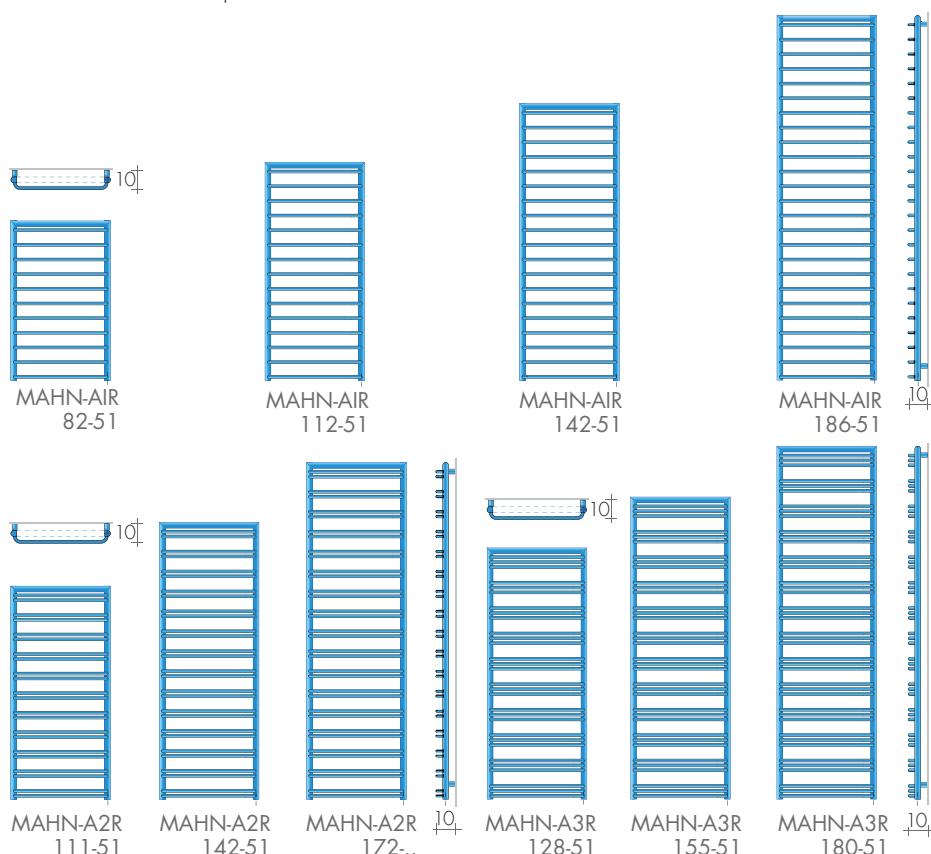

HEATING ELEMENT POSITION  
© Vertical Heating Element



MODEL	H - L cm	Standard white	BREM Colors	BREM Colors	KIT HEATING ELEMENT with:		
		sablé SB 9016 €	+15% €	+25% €	Cable R..E Art. (W)	Faston R..T Art. (W)	€
MAHN-AIR	82-51	525,50	604,30	656,90	R300IIE	R300IIT	193,80
MAHN-AIR	112-51	594,20	683,30	742,80	R400IIE	R400IIT	195,70
MAHN-AIR	142-51	751,00	863,70	938,80	R500IIE	R500IIT	208,50
MAHN-AIR	186-51	867,10	997,20	1083,90	R650IIE	R650IIT	222,90
MAHN-A2R	111-51	705,50	811,30	881,90	R500IIE	R500IIT	208,50
MAHN-A2R	142-51	839,30	965,20	1049,10	R650IIE	R650IIT	222,90
MAHN-A2R	172-51	929,00	1068,40	1161,30	R800IIE	R800IIT	240,50
MAHN-A2R	172-61	976,60	1123,10	1220,80	R900IIE	R900IIT	255,30
MAHN-A3R	128-51	861,80	991,10	1077,30	R650IIE	R650IIT	222,90
MAHN-A3R	155-51	942,50	1083,90	1178,10	R800IIE	R800IIT	240,50
MAHN-A3R	180-51	1012,70	1164,60	1265,90	R900IIE	R900IIT	255,30

CHROME HOOK, only Mahn-A2R et A3R  
(ø 3 x 3,5 cm)p.277 Art. AC n°2 90,90€



## ELECTRIC VERSIONS

THERMOSTATS IN THE RADIATOR FOR KIT RT P. 209

THERMOSTAT mod. DYP



White with  
white cable cover  
Art. DYPB 89,60€

ø 7 x 9 x 5 cm



Black with  
black cable cover  
Art. DYPN 103,40€

REMOTE CONTROL for thermostats DYP

10,8 x 5,3 x 2,3 cm



Art. TIR 41,00€

THERMOSTAT CIRCLE Wi-Fi  
up to 800 W  
heating elements



ø 6 x 8 h x 5 cm



Chrome/Black finish  
Art. CIR-wifi 198,50€



TECHNICAL DATA and other dimensions p. 138  
ELECTRIC KIT DATA p. 208-209

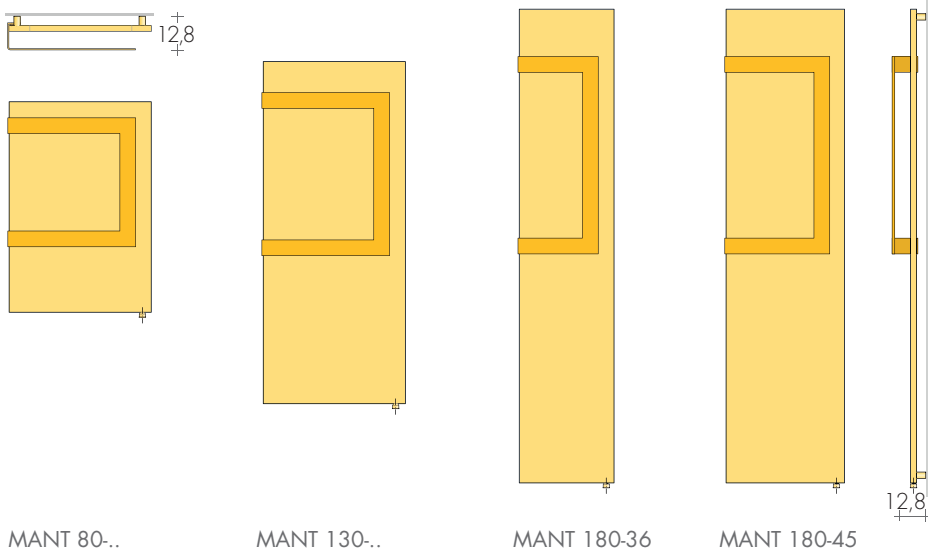

MODEL	H - L cm	Standard white	BREM Colors	BREM Colors	KIT HEATING ELEMENT with:		
		sablé SB 9016 €	+15% €	+25% €	Cable R.E Art. (W)	Faston R.T Art. (W)	€
MANT	80-45	862,70	992,10	1078,40	R400IIE	R400IIT	195,70
MANT	80-54	940,50	1081,60	1175,60	R500IIE	R500IIT	208,50
MANT	130-45	1032,50	1187,40	1290,60	R650IIE	R650IIT	222,90
MANT	130-54	1121,20	1289,40	1401,50	R800IIE	R800IIT	240,50
MANT	180-36	1100,10	1265,10	1375,10	R650IIE	R650IIT	222,90
MANT	180-45	1202,30	1382,60	1502,90	R900IIE	R900IIT	255,30

TOWEL BAR MANT: STANDARD COLORS  
 - white sablé SB 9016 - quartz grey SB 7039  
 - black sablé SB 9005 - same color as the radiator  
 In one paintwork to Brem color list different from the radiator  
 Extra Art. CM 52,90€

On request, free of charge, the bar on the right

HEATING ELEMENT POSITION  
 ☉ Vertical Heating Element



## THERMOSTATS Wi-Fi FOR KIT RE P. 208

## ACCESSORIES FOR



E.H.E. white cable cover  
or radiator color (together)  
 Art.CCRE38 ø3/8" 73,40€  
 Art.CCRE12 ø1/2" 73,40€

The KIT RT Wi-Fi includes:  
 - Thermostat RT (battery)  
 - Gateway  
 - Built-in receiver

Art. KITRT-wifi 199,80€

Additional receiver  
 (up to 6) radiators)



Art. SA868 64,20€

KIT ELY Wi-Fi TOP DESIGN includes:  
 - Thermostat with magnetic charging base  
and magnetic plate for wall mounting  
 - Gateway a 230V  
 - Built-in Receiver

Art. KITELY-wifi 396,10€

Additional receiver: 1 for each electrical radiators  
or split AC (up to 16)



Art. SA600 99,10€



TECHNICAL DATA and other dimensions p. 106  
ELECTRIC KIT DATA p. 208-209

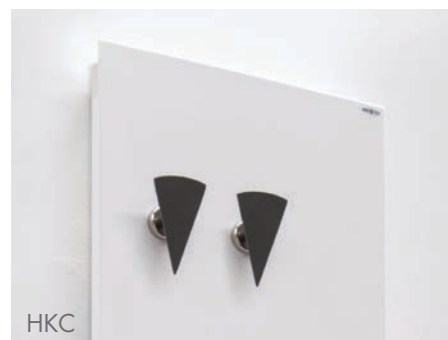
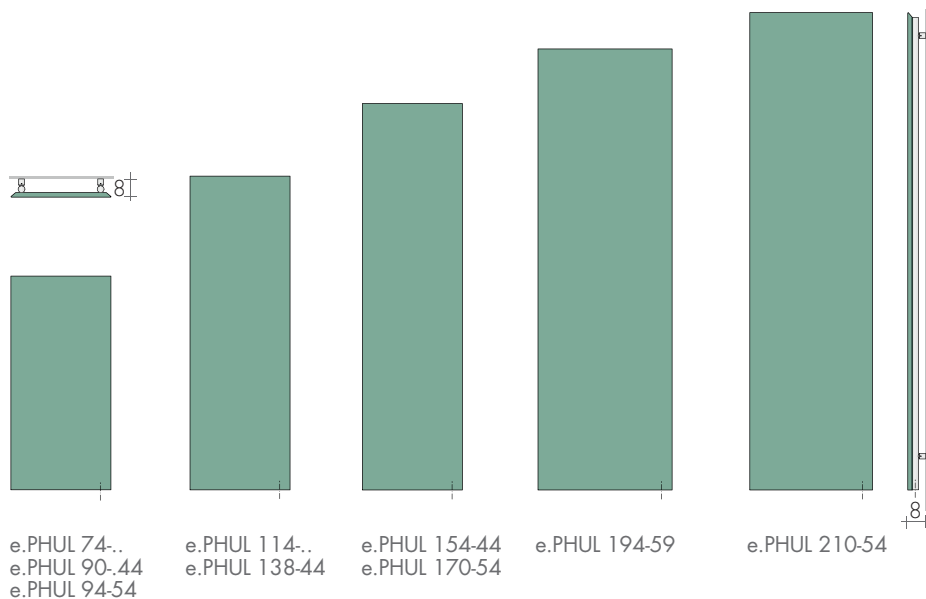

MODEL'25	H-L cm	Standard white sablé SB 9016 €	BREM Colors		KIT HEATING ELEMENT with:		
			+15% €	+25% €	Cable R.E Art. (WV)	Faston R.T Art. (WV)	€
PHUL	74-44	607,90	699,10	759,90	R400IIE	R400IIT	195,70
PHUL	74-54	667,10	767,20	833,90	R500IIE	R500IIT	208,50
PHUL	90-44	684,30	786,90	855,40	R500IIE	R500IIT	208,50
PHUL	94-54	726,30	835,20	907,90	R650IIE	R650IIT	222,90
PHUL	114-44	746,90	858,90	933,60	R650IIE	R650IIT	222,90
PHUL	114-54	795,80	915,20	994,80	R800IIE	R800IIT	240,50
PHUL	138-44	821,10	944,30	1026,40	R800IIE	R800IIT	240,50
PHUL	154-44	866,40	996,40	1083,00	R900IIE	R900IIT	255,30
PHUL	170-54	1077,10	1238,70	1346,40	R1200IIE	R1200IIT	276,30
PHUL	194-59	1256,30	1444,70	1570,40	R1500IIE	R1500IIT	298,00
PHUL	210-54	1281,40	1473,60	1601,80	R1500IIE	R1500IIT	298,00

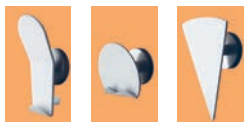

KNOBS with magnet  
page 277

TOWEL BAR MAGNET  
page 277

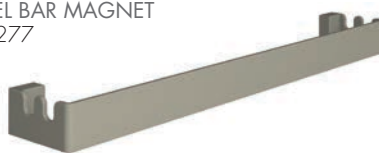

HEATING ELEMENT POSITION  
© Vertical Heating Element



## ELECTRIC VERSIONS

## THERMOSTATS IN THE RADIATOR FOR KIT RT P. 209

THERMOSTAT mod. DYP



White with  
white cable cover  
Art. DYPB 89,60€

ø 7 x 9 x 5 cm



Black with  
black cable cover  
Art. DYPN 103,40€

REMOTE CONTROL for thermostats DYP

10,8 x 5,3 x 2,3 cm



Art. TIR 41,00€

THERMOSTAT CIRCLE Wi-Fi  
up to 800 W  
heating elements



ø 6 x 8 x 5 cm



Chrome/Black finish  
Art. CIR-wifi 198,50€



design Pietro Facheris

TECHNICAL DATA and other dimensions p. 78  
ELECTRIC KIT DATA p. 208-209

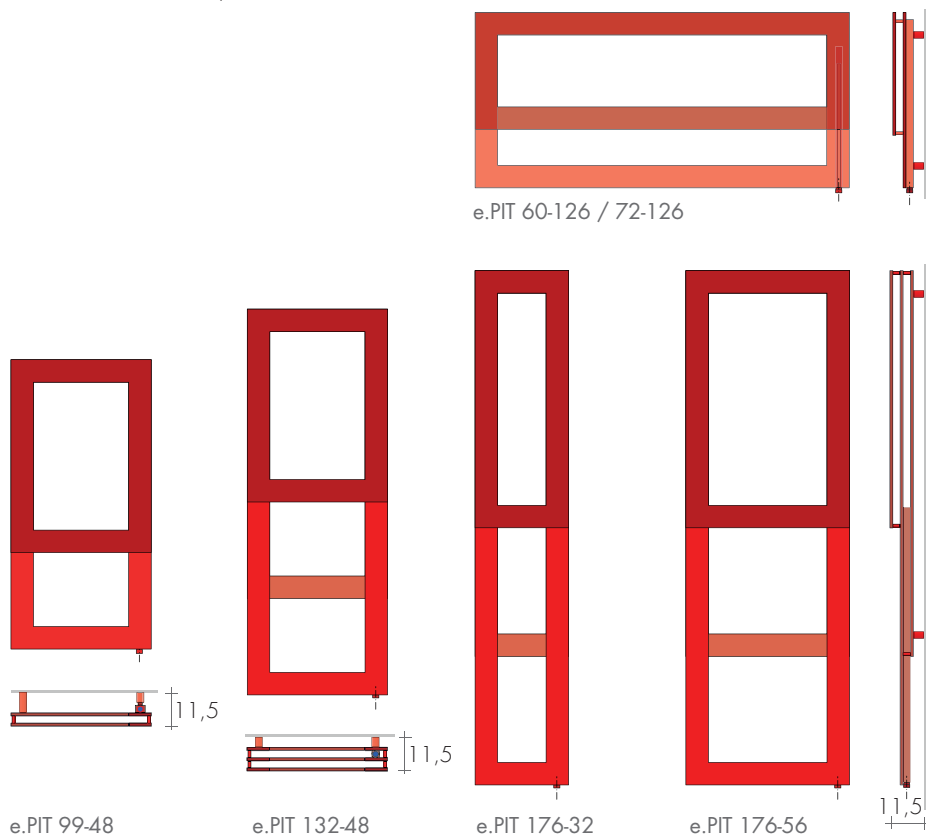

MODEL	H - L cm	Standard white sablé SB 9016 €	BREM Colors		KIT HEATING ELEMENT with:		
			+15% €	+25% €	Cable R.E Art. (W)	Faston R.T Art. (W)	€
e.PIT 60-126	60-126	1093,80	1257,90	1367,30	R650IIE	R650IIT	222,90
e.PIT 72-126	72-126	1314,30	1511,40	1642,90	R900IIE	R900IIT	255,30
e.PIT 99-48	99-48	849,90	977,40	1062,40	R400IIE	R400IIT	195,70
e.PIT 132-48	132-48	1153,90	1327,00	1442,40	R650IIE	R650IIT	222,90
e.PIT 176-32	176-32	1237,80	1423,50	1547,30	R800IIE	R800IIT	240,50
e.PIT 176-56	176-56	1344,30	1545,90	1680,40	R900IIE	R900IIT	255,30

Prices include the additional manifold

HEATING ELEMENT POSITION  
© Vertical Heating Element



G

THERMOSTATS Wi-Fi FOR KIT RE P. 208

ACCESSORIES FOR

E.H.E. white cable cover  
or radiator color (together)  
Art.CCRE38 ø3/8" 73,40€  
Art.CCRE12 ø1/2" 73,40€



The KIT RT Wi-Fi includes:  
- Thermostat RT (battery)  
- Gateway  
- Built-in receiver

Art. KITRT-wifi 199,80€

Additional receiver  
(up to 6) radiators)



Art. SA868 64,20€

KIT ELY Wi-Fi TOP DESIGN includes:  
- Thermostat with magnetic charging base  
and magnetic plate for wall mounting  
- Gateway a 230V  
- Built-in Receiver

Art. KITELY-wifi 396,10€

Additional receiver: 1 for each electrical radiators  
or split AC (up to 16)



Art. SA600 99,10€



TECHNICAL DATA and other dimensions p. 182,184  
ELECTRIC KIT DATA p. 208-209

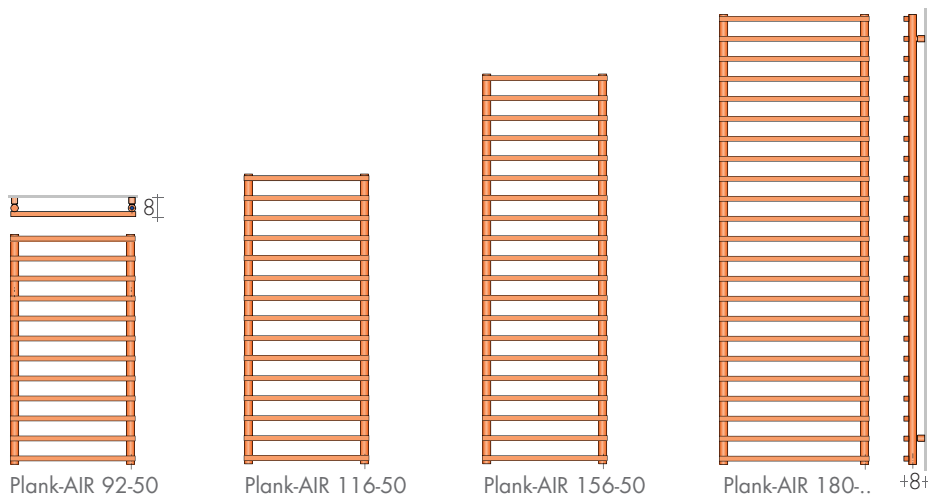
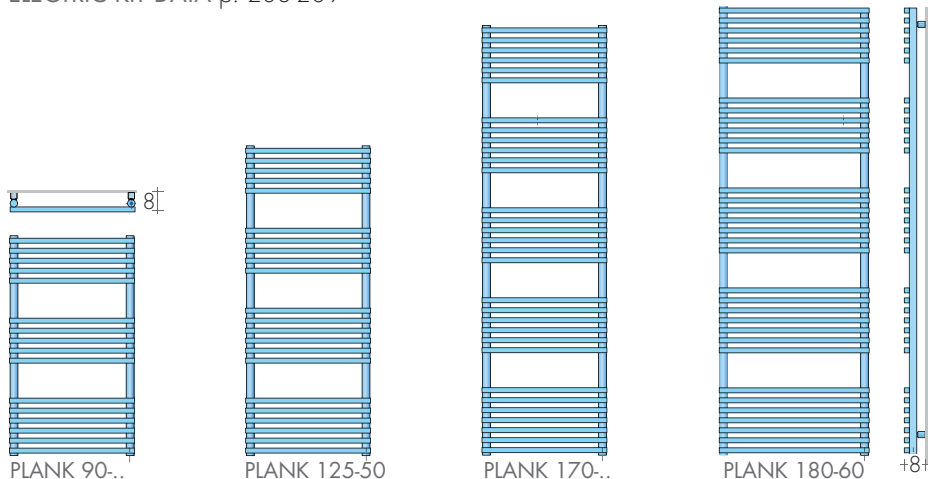

MODEL	H - L cm	Standard white	BREM Colors		KIT HEATING ELEMENT with:		
		sablé SB 9016 €	+15% €	+25% €	Cable R.E Art. (W)	Faston R.T Art. (W)	€
PLANK	90-40	365,80	420,70	457,30	R400IIE	R400IIT	195,70
PLANK	90-50	379,70	436,70	474,60	R500IIE	R500IIT	208,50
PLANK	125-50	506,40	582,40	633,00	R650IIE	R650IIT	222,90
PLANK	170-40	669,80	770,30	837,30	R800IIE	R800IIT	240,50
PLANK	170-50	696,20	800,60	870,30	R900IIE	R900IIT	255,30
PLANK	180-60	763,70	878,30	954,60	R1200IIE	R1200IIT	276,30
Plank-AIR	92-50	352,90	405,80	441,10	R400IIE	R400IIT	195,70
Plank-AIR	116-50	446,10	513,00	557,60	R500IIE	R500IIT	208,50
Plank-AIR	156-50	528,40	607,70	660,50	R650IIE	R650IIT	222,90
Plank-AIR	180-50	610,80	702,40	763,50	R800IIE	R800IIT	240,50
Plank-AIR	180-60	649,20	746,60	811,50	R900IIE	R900IIT	255,30

HEATING ELEMENT POSITION  
© Vertical Heating Element



## ELECTRIC VERSIONS

THERMOSTATS IN THE RADIATOR FOR KIT RT P. 209

THERMOSTAT mod. DYP



White with white cable cover  
Art. DYPB 89,60€

ø 7 x 9 x 5 cm



Black with black cable cover  
Art. DYPN 103,40€

REMOTE CONTROL for thermostats DYP

10,8 x 5,3 x 2,3 cm



Art. TIR 41,00€

THERMOSTAT CIRCLE Wi-Fi  
up to 800 W  
heating elements



ø 6 x 8 x 5 cm



Chrome/Black finish  
Art. CIR-wifi 198,50€



# e.PLATT

## COLOR/INOX/GILDED-SILVER LEAF

PRICE FROM 01.03.2026 **+5%**

TECHNICAL DATA and other dimensions p.140-143  
ELECTRIC KIT DATA p. 208-209

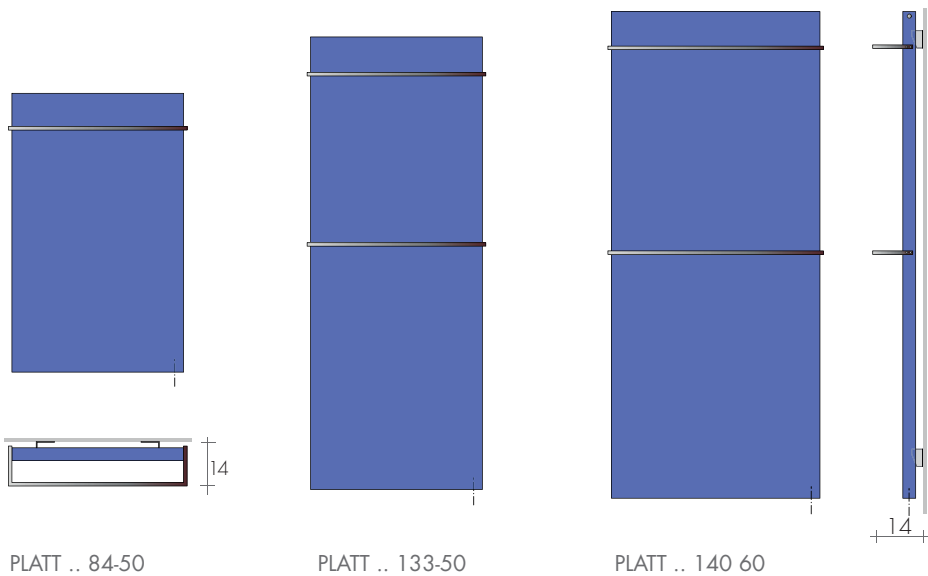

MODEL	H - L cm	Standard white	BREM Colors	BREM Colors	KIT HEATING ELEMENT with:		
		sablé SB 9016 €	+15% €	+25% €	Cable R..E Art. (VV)	Faston R..T Art. (VV)	€
Platt COLOR 84-50	84-50	853,40	981,40	1066,80	R400IIE	R400IIT	195,70
Platt COLOR 133-50	133-50	1154,10	1327,20	1442,60	R650IIE	R650IIT	222,90
Platt COLOR 140-60	140-60	1306,90	1502,90	1633,60	R800IIE	R800IIT	240,50
PLATT INOX SATIN							
Platt INOX 84-50	84-50	1247,40	-	-	R400IIE	R400IIT	195,70
Platt INOX 133-50	133-50	1635,90	-	-	R650IIE	R650IIT	222,90
Platt INOX 140-60	140-60	1734,70	-	-	R800IIE	R800IIT	240,50
FO GILDED LEAF/ FA SILVER LEAF							
Platt FO/FA 84-50	84-50	1613,00	-	-	R400IIE	R400IIT	195,70
Platt FO/FA 133-50	133-50	2130,70	-	-	R650IIE	R650IIT	222,90
Platt FO/FA 140-60	140-60	2417,80	-	-	R800IIE	R800IIT	240,50

TOWEL BAR PLATT: STANDARD COLORS  
- white sablé SB 9016 - quartz grey SB 7039  
- black sablé SB 9005 - same color as the radiator  
In one paintwork to Brem color list different from the radiator  
Extra Art. CM 52,90€

Towel bar in BR0019 color for gilded leaf, in BR0002 color for silver leaf as standard.  
Gilded/silver leaf towel bar Extra (each) 150,90€  
Chrome-plated towel bar as standard for Platt Color

HEATING ELEMENT POSITION  
© Vertical Heating Element

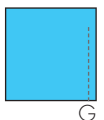

### THERMOSTATS Wi-Fi FOR KIT RE P. 208

### ACCESSORIES FOR



E.H.E. white cable cover or radiator color (together)  
Art.CCRE38 ø3/8" 73,40€  
Art.CCRE12 ø1/2" 73,40€

The KIT RT Wi-Fi includes:  
- Thermostat RT (battery)  
- Gateway  
- Built-in receiver

Art. KITRT-wifi 199,80€

Additional receiver (up to 6) radiators)



Art. SA868 64,20€

KIT ELY Wi-Fi TOP DESIGN includes:  
- Thermostat with magnetic charging base and magnetic plate for wall mounting  
- Gateway a 230V  
- Built-in Receiver

Art. KITELY-wifi 396,10€

Additional receiver: 1 for each electrical radiators or split AC (up to 16) Art. SA600 99,10€



TECHNICAL DATA and other dimensions p. 186  
ELECTRIC KIT DATA p. 208-209

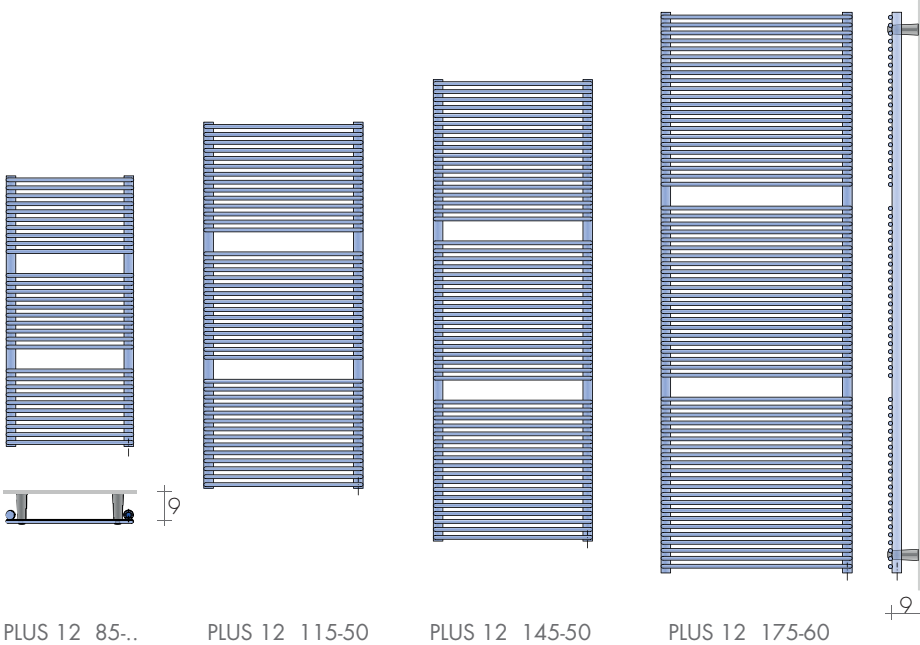

MODEL'25	H - L cm	Standard white sablé SB 9016 €	BREM Colors +15% €	BREM Colors +25% €	KIT HEATING ELEMENT with:		
					Cable R..E Art. (W)	Faston R..T Art. (W)	€
PLUS 12	85-40	394,10	453,20	492,60	R400IIE	R400IIT	195,70
PLUS 12	85-50	401,50	461,70	501,90	R500IIE	R500IIT	208,50
PLUS 12	115-50	576,90	663,40	721,10	R650IIE	R650IIT	222,90
PLUS 12	145-50	662,60	762,00	828,30	R800IIE	R800IIT	240,50
PLUS 12	175-60	788,50	906,80	985,60	R1200IIE	R1200IIT	276,30

CHROME HOOK  
ø3 x 3,5 cm, p. 277 Art. AC n°2 90,90€

HEATING ELEMENT POSITION  
© Vertical Heating Element

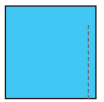

## ELECTRIC VERSIONS

THERMOSTATS IN THE RADIATOR FOR KIT RT P. 209

THERMOSTAT mod. DYP



White with  
white cable cover  
Art. DYPB 89,60€

ø 7 x 9 x 5 cm



Black with  
black cable cover  
Art. DYPN 103,40€

REMOTE CONTROL for thermostats DYP

10,8 x 5,3 x 2,3 cm



Art. TIR 41,00€

THERMOSTAT CIRCLE Wi-Fi  
up to 800 W  
heating elements



ø 6 x 8 x 5 cm



Chrome/Black finish  
Art. CIR-wifi 198,50€



TECHNICAL DATA and other dimensions p. 188-190  
ELECTRIC KIT DATA p. 208-209

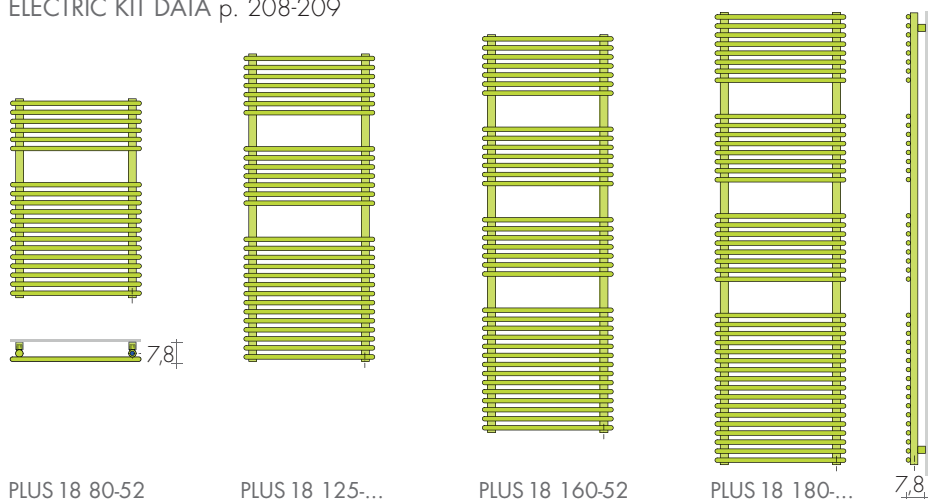

PLUS 18 80-52

PLUS 18 125-...

PLUS 18 160-52

PLUS 18 180-...

78

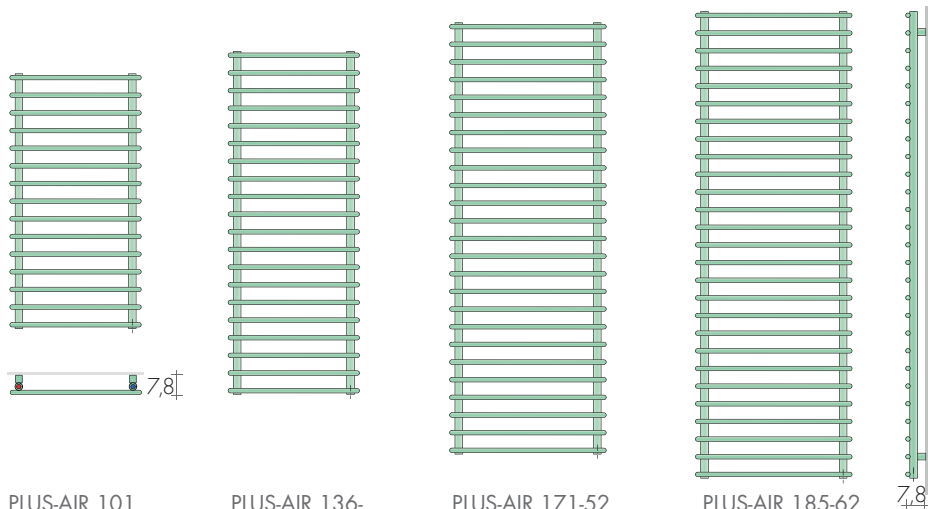

PLUS-AIR 101..

PLUS-AIR 136..

PLUS-AIR 171-52

PLUS-AIR 185-62

78

MODEL	H - L cm	Standard white	BREM Colors	BREM Colors	KIT HEATING ELEMENT with:		
		sablé SB 9016 €	+15% €	+25% €	Cable R..E Art. (W)	Faston R..T Art. (W)	€
PLUS 18	80-52	302,40	347,80	378,00	R400IIE	R400IIT	195,70
PLUS 18	125-42	379,70	436,70	474,60	R500IIE	R500IIT	208,50
PLUS 18	125-52	393,80	452,90	492,30	R650IIE	R650IIT	222,90
PLUS 18	160-52	478,10	549,80	597,60	R800IIE	R800IIT	240,50
PLUS 18	180-52	562,60	647,00	703,30	R900IIE	R900IIT	255,30
PLUS 18	180-62	586,50	674,50	733,10	R1200IIE	R1200IIT	276,30
PLUS-AIR	101-42	322,80	371,20	403,50	R300IIE	R300IIT	193,80
PLUS-AIR	101-52	334,80	385,00	418,50	R400IIE	R400IIT	195,70
PLUS-AIR	136-42	368,40	423,70	460,50	R400IIE	R400IIT	195,70
PLUS-AIR	136-52	382,00	439,30	477,50	R500IIE	R500IIT	208,50
PLUS-AIR	171-52	435,10	500,40	543,90	R650IIE	R650IIT	222,90
PLUS-AIR	185-62	498,60	573,40	623,30	R800IIE	R800IIT	240,50



HEATING ELEMENT POSITION  
© Vertical Heating Element

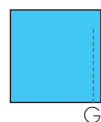

## THERMOSTATS Wi-Fi FOR KIT RE P. 208

## ACCESSORIES FOR

E.H.E. white cable cover  
or radiator color (together)  
Art.CCRE38 ø3/8" 73,40€  
Art.CCRE12 ø1/2" 73,40€



The KIT RT Wi-Fi includes:  
- Thermostat RT (battery)  
- Gateway  
- Built-in receiver

Art. KITRT-wifi 199,80€

Additional receiver  
(up to 6) radiators)

Art. SA868 64,20€



KIT ELY Wi-Fi TOP DESIGN includes:  
- Thermostat with magnetic charging base  
and magnetic plate for wall mounting  
- Gateway a 230V  
- Built-in Receiver

Art. KITELY-wifi 396,10€

Additional receiver: 1 for each electrical radiators  
or split AC (up to 16) Art. SA600 99,10€



design Luigi Brembilla

TECHNICAL DATA and other dimensions p. 80  
ELECTRIC KIT DATA p. 208-209

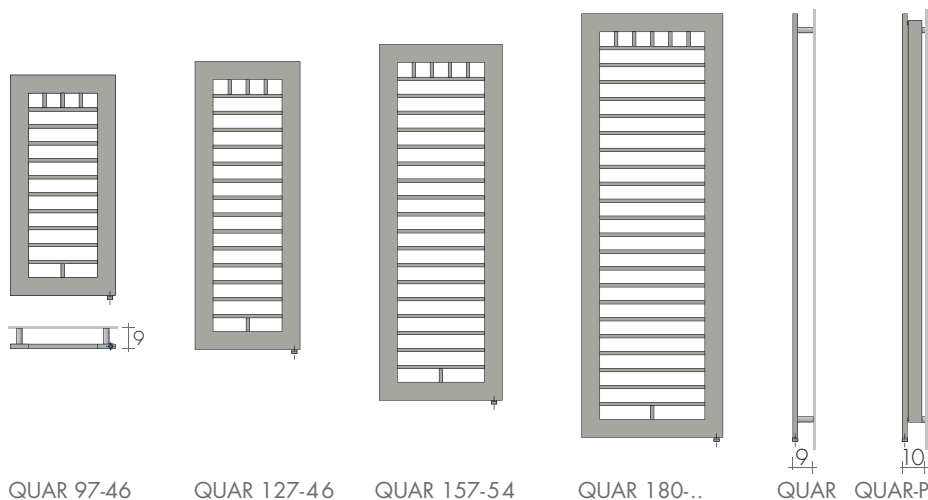

MODEL	H - L cm	Standard white	BREM Colors	BREM Colors	KIT HEATING ELEMENT with:		
		sablé SB 9016 €	+15% €	+25% €	Cable R.E Art. (W)	Faston R.T Art. (W)	€
QUAR	97-46	868,10	998,30	1085,10	R400IIE	R400IIT	195,70
QUAR	127-46	936,50	1077,00	1170,60	R500IIE	R500IIT	208,50
QUAR	157-54	1060,90	1220,00	1326,10	R650IIE	R650IIT	222,90
QUAR-P	157-54	1318,00	1515,70	1647,50	R900IIE	R900IIT	255,30
QUAR	180-62	1204,60	1385,30	1505,80	R800IIE	R800IIT	240,50
QUAR-P	180-38	1388,70	1597,00	1735,90	R900IIE	R900IIT	255,30
QUAR-P	180-62	1461,80	1681,10	1827,30	R1200IIE	R1200IIT	276,30

HEATING ELEMENT POSITION  
© Vertical Heating Element



## ELECTRIC VERSIONS

THERMOSTATS IN THE RADIATOR FOR KIT RT P. 209

THERMOSTAT mod. DYP



White with  
white cable cover  
Art. DYPB 89,60€

ø 7 x 9 x 5 cm



Black with  
black cable cover  
Art. DYPN 103,40€

REMOTE CONTROL for thermostats DYP

10,8 x 5,3 x 2,3 cm



Art. TIR 41,00€

THERMOSTAT CIRCLE Wi-Fi  
up to 800 W  
heating elements



ø 6 x 8 x 5 cm



Chrome/Black finish  
Art. CIR-wifi 198,50€



design Davide Diliberto

TECHNICAL DATA and other dimensions p. 192 and 194  
ELECTRIC KIT DATA p. 208-209  
Below, the main dimensions for bathrooms.

## HORIZONTAL MODELS

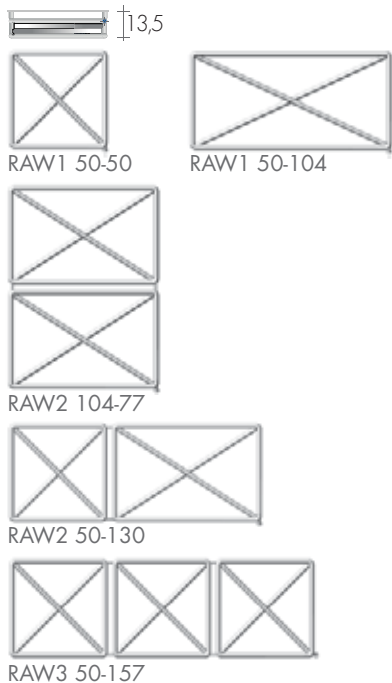

## VERTICAL MODELS

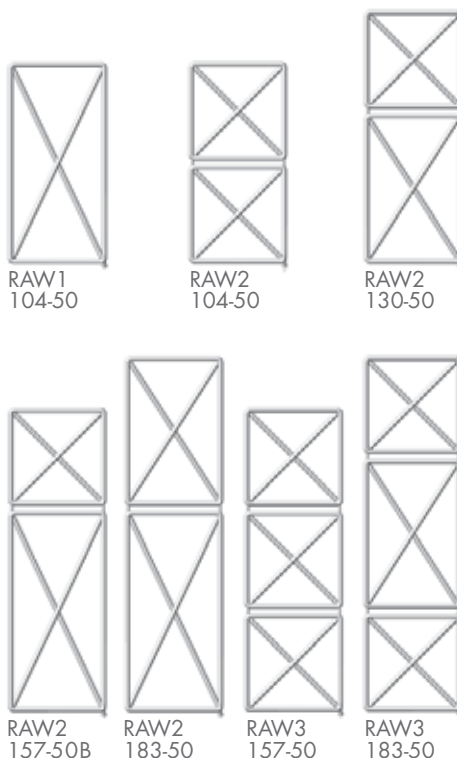

MODEL	H - L cm	Standard white	BREM Colors		KIT HEATING ELEMENT with:		
		sablé SB 9016 €	+15% €	+25% €	Cable R..E Art. (W)	Faston R..T Art. (W)	€
<b>HORIZONTAL MODELS</b>							
RAW1	50-50	632,90	727,80	791,10	R300IIE	R300IIT	193,80
RAW1	50-104	815,80	938,20	1019,80	R400IIE	R400IIT	195,70
RAW2	50-130	1118,10	1285,80	1397,60	R650IIE	R650IIT	222,90
RAW3*	50-157	1476,80	1698,30	1846,00	R800IIE	R800IIT	240,50
<b>VERTICAL MODELS</b>							
RAW1	104-50	815,80	938,20	1019,80	R400IIE	R400IIT	195,70
RAW2	104-50	1054,90	1213,10	1318,60	R500IIE	R500IIT	208,50
RAW2	104-77	1181,40	1358,60	1476,80	R800IIE	R800IIT	240,50
RAW2	130-50	1118,10	1285,80	1397,60	R650IIE	R650IIT	222,90
RAW2	157-50B	1181,40	1358,60	1476,80	R800IIE	R800IIT	240,50
RAW2	183-50	1216,50	1399,00	1520,60	R800IIE	R800IIT	240,50
RAW3	157-50	1476,80	1698,30	1846,00	R900IIE	R900IIT	255,30
RAW3	183-50	1504,90	1730,60	1881,10	R900IIE	R900IIT	255,30

\* Horizontal Heating El.

On request, RAW module compositions according to design



HEATING EL. POSITION  
Ⓓ Horizontal Heating El.  
Ⓒ Vertical Heating Element

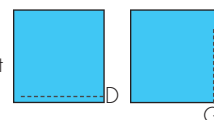

## THERMOSTATS Wi-Fi FOR KIT RE P. 208

## ACCESSORIES FOR

E.H.E. white cable cover  
or radiator color (together)  
Art.CCRE38 ø3/8" 73,40€  
Art.CCRE12 ø1/2" 73,40€



The KIT RT Wi-Fi includes:  
- Thermostat RT (battery)  
- Gateway  
- Built-in receiver

Art. KITRT-wifi 199,80€

Additional receiver  
(up to 6) radiators)

Art. SA868 64,20€



KIT ELY Wi-Fi TOP DESIGN includes:  
- Thermostat with magnetic charging base  
and magnetic plate for wall mounting  
- Gateway a 230V  
- Built-in Receiver

Art. KITELY-wifi 396,10€

Additional receiver: 1 for each electrical radiators  
or split AC (up to 16) Art. SA600 99,10€



TECHNICAL DATA and other dimensions p. 22  
ELECTRIC KIT DATA p. 208-209

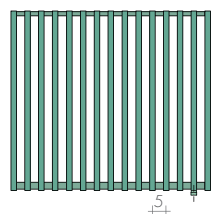

R 75/50..el  
step 50

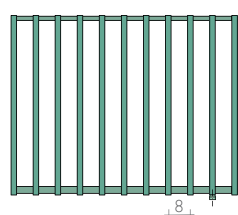

R 75/80..el  
step 80

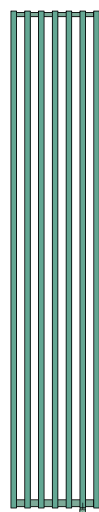
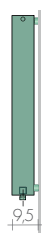

R../50..el  
step 50

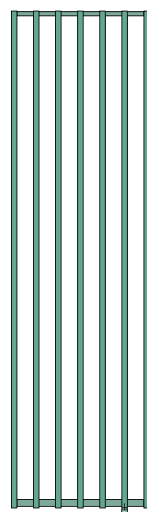

R../80..el  
step 50

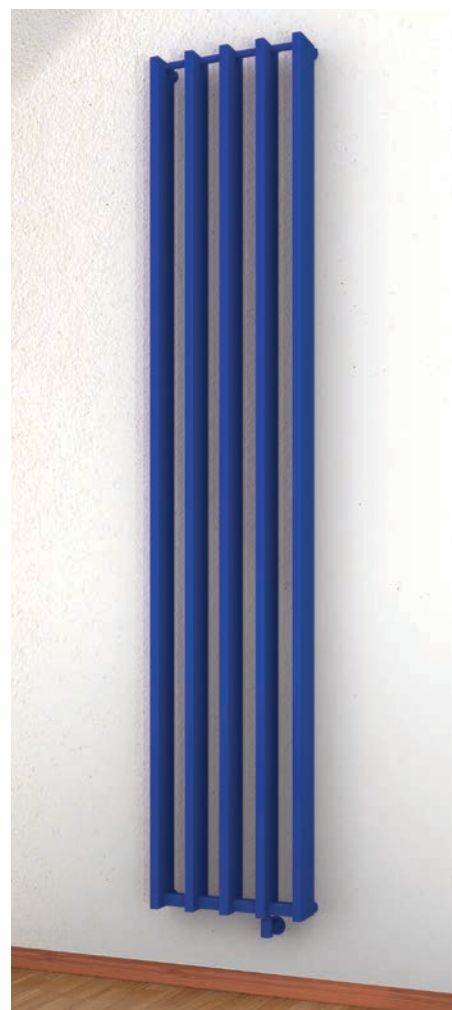

MODEL	Standard white sablé SB 9016		BREM Colors		KIT HEATING ELEMENT with:		
	H/step	n°él.	+15%	+25%	Cable R.E Art. (W)	Faston R.T Art. (W)	€
R 75/80-9el	66	645,50	742,30	806,90	R650IIE	R650IIT	222,90
R 75/80-11el	82	748,30	860,50	935,40	R800IIE	R800IIT	240,50
R 75/80-13el	98	851,20	978,90	1064,00	R900IIE	R900IIT	255,30
R 75/50-11el	52	748,30	860,50	935,40	R650IIE	R650IIT	222,90
R 75/50-13el	62	851,20	978,90	1064,00	R800IIE	R800IIT	240,50
R 75/50-15el	72	954,00	1097,10	1192,50	R900IIE	R900IIT	255,30
R180/80-5el	34	864,90	994,60	1081,10	R800IIE	R800IIT	240,50
R180/80-7el	50	1070,50	1231,10	1338,10	R1200IIE	R1200IIT	276,30
R200/50-6el	27	1011,40	1163,10	1264,30	R900IIE	R900IIT	255,30
R200/50-8el	37	1225,80	1409,70	1532,30	R1200IIE	R1200IIT	276,30
R200/50-10el	47	1440,10	1656,10	1800,10	R1500IIE	R1500IIT	298,00
R200/80-8el	58	1225,80	1409,70	1532,30	R1500IIE	R1500IIT	298,00

PE = step (distance between the midpoints of 2 elements)

HEATING EL. POSITION  
© Vertical Heating Elemen

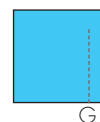

## ELECTRIC VERSIONS

THERMOSTATS IN THE RADIATOR FOR KIT RT P. 209

THERMOSTAT mod. DYP



White with  
white cable cover  
Art. DYPB 89,60€

ø 7 x 9 x 5 cm



Black with  
black cable cover  
Art. DYPN 103,40€

REMOTE CONTROL for thermostats DYP

10,8 x 5,3 x 2,3 cm



Art. TIR 41,00€

THERMOSTAT CIRCLE Wi-Fi  
up to 800 W  
heating elements



ø 6 x 8 x 5 cm



Chrome/Black finish  
Art. CIR-wifi 198,50€



TECHNICAL DATA and other dimensions p. 24  
ELECTRIC KIT DATA p. 208-209

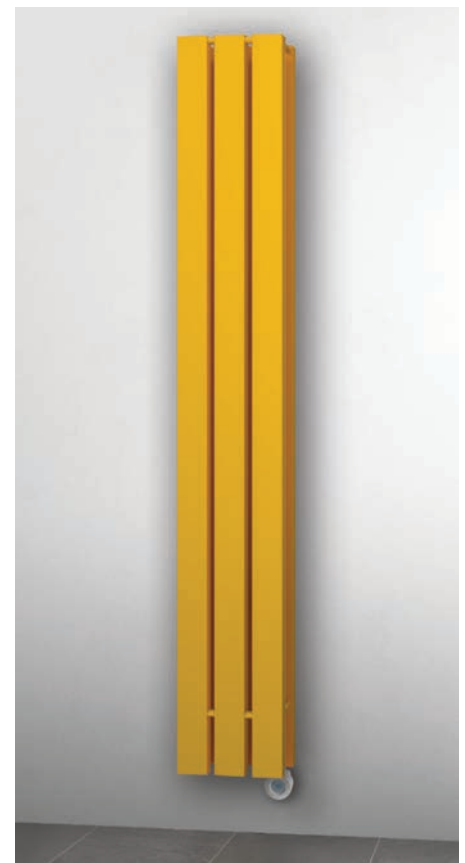
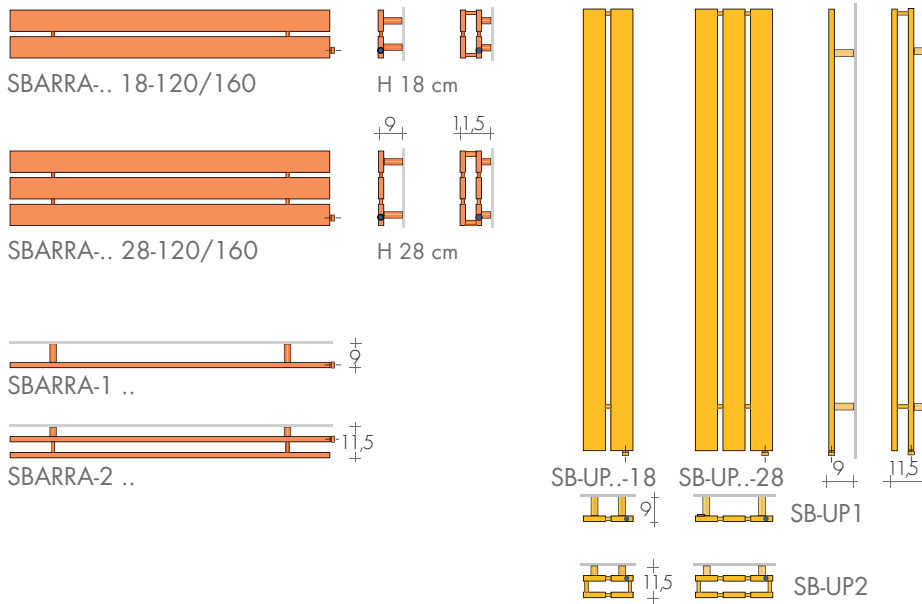

MODEL	H - L cm	Standard white sablé SB 9016 €	BREM Colors		KIT HEATING ELEMENT with:		
			+15% €	+25% €	Cable R.E Art. (W)	Faston R.T Art. (W)	€
SBARRA-1	18-120	508,30	584,50	635,40	R300IIE	R300IIT	193,80
SBARRA-1	18-160	568,20	653,40	710,30	R400IIE	R400IIT	195,70
SBARRA-1	28-120	615,80	708,20	769,80	R400IIE	R400IIT	195,70
SBARRA-1	28-160	684,40	787,10	855,50	R500IIE	R500IIT	208,50
SBARRA-2	18-120	994,30	1143,40	1242,90	R500IIE	R500IIT	208,50
SBARRA-2	18-160	1094,70	1258,90	1368,40	R650IIE	R650IIT	222,90
SBARRA-2	28-120	1198,50	1378,30	1498,10	R650IIE	R650IIT	222,90
SBARRA-2	28-160	1316,10	1513,50	1645,10	R800IIE	R800IIT	240,50
SB-UP1	180-18	585,20	673,00	731,50	R400IIE	R400IIT	195,70
SB-UP2	180-18	1112,00	1278,80	1390,00	R650IIE	R650IIT	222,90
SB-UP2	180-28	1333,20	1533,20	1666,50	R900IIE	R900IIT	255,30
SB-UP1	220-18	622,40	715,80	778,00	R500IIE	R500IIT	208,50
SB-UP2	220-18	1149,30	1321,70	1436,60	R800IIE	R800IIT	240,50
SB-UP2	220-28	1370,30	1575,80	1712,90	R1200IIE	R1200IIT	276,30

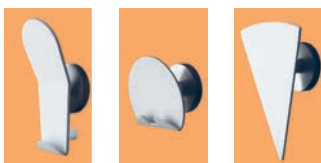

KNOBS with magnet page 277

HEATING EL. POSITION  
Ⓓ Horizontal Heating El.  
Ⓒ Vertical Heating Element

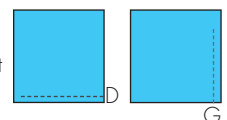

## THERMOSTATS Wi-Fi FOR KIT RE P. 208

## ACCESSORIES FOR

E.H.E. white cable cover  
or radiator color (together)  
Art.CCRE38 ø3/8" 73,40€  
Art.CCRE12 ø1/2" 73,40€



The KIT RT Wi-Fi includes:  
- Thermostat RT (battery)  
- Gateway  
- Built-in receiver

Art. KITRT-wifi 199,80€

Additional receiver  
(up to 6) radiators)



Art. SA868 64,20€

KIT ELY Wi-Fi TOP DESIGN includes:  
- Thermostat with magnetic charging base  
and magnetic plate for wall mounting  
- Gateway a 230V  
- Built-in Receiver

Art. KITELY-wifi 396,10€

Additional receiver: 1 for each electrical radiators  
or split AC (up to 16) Art. SA600 99,10€



TECHNICAL DATA and other dimensions p. 196  
ELECTRIC KIT DATA p. 208-209

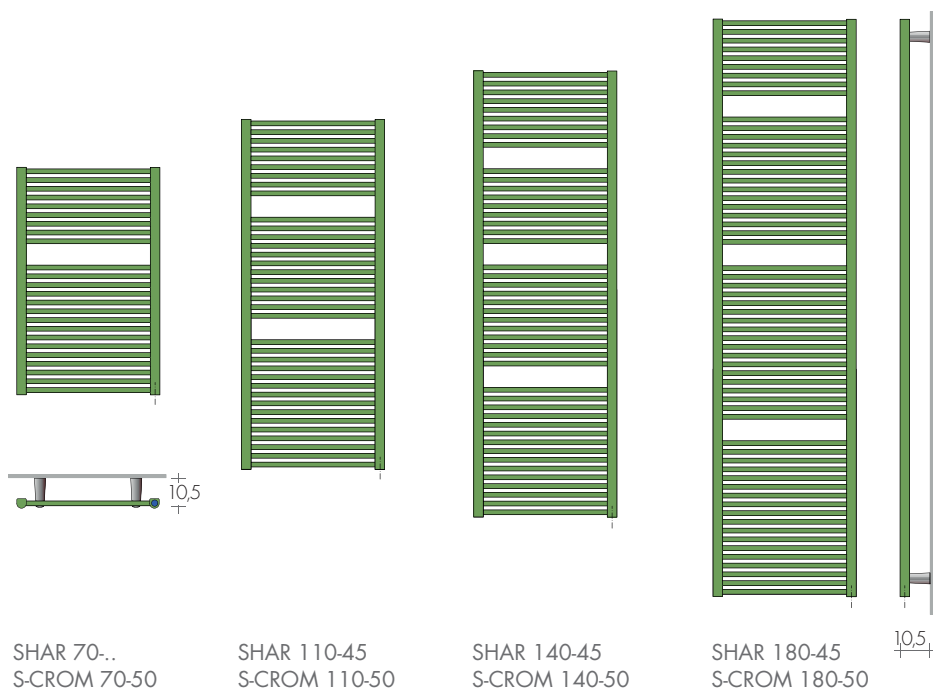

SHAR 70-  
S-CROM 70-50

SHAR 110-45  
S-CROM 110-50

SHAR 140-45  
S-CROM 140-50

SHAR 180-45  
S-CROM 180-50

MODEL	H - L cm	Standard white sablé SB 9016 €	BREM Colors		KIT HEATING ELEMENT with:		
			+15% €	+25% €	Cable R.E Art. (W)	Faston R.T Art. (W)	€
SHAR	70-50	410,90	472,50	513,60	R400IIE	R400IIT	195,70
SHAR	70-60	427,10	491,20	533,90	R500IIE	R500IIT	208,50
SHAR	110-45	519,70	597,70	649,60	R500IIE	R500IIT	208,50
SHAR	140-45	653,50	751,50	816,90	R650IIE	R650IIT	222,90
SHAR	180-45	798,80	918,60	998,50	R900IIE	R900IIT	255,30
CHROME-PLATED FINISH							
S-CROM	70-50	896,40	-	-	R300IIE	R300IIT	193,80
S-CROM	110-50	1162,70	-	-	R500IIE	R500IIT	208,50
S-CROM	140-50	1465,40	-	-	R650IIE	R650IIT	222,90
S-CROM	180-50	1789,30	-	-	R800IIE	R800IIT	240,50

CHROME HOOK  
(ø 3 x 3,5 cm) p.277 Art. AC n°2 90,90€



HEATING ELEMENT POSITION  
© Vertical Heating Element



## ELECTRIC VERSIONS

## THERMOSTATS IN THE RADIATOR FOR KIT RT P. 209

THERMOSTAT mod. DYP



White with  
white cable cover  
Art. DYPB 89,60€

ø 7 x 9 x 5 cm



Black with  
black cable cover  
Art. DYPN 103,40€

REMOTE CONTROL for thermostats DYP

10,8 x 5,3 x 2,3 cm



Art. TIR 41,00€

THERMOSTAT CIRCLE Wi-Fi  
up to 800 W  
heating elements



ø 6 x 8 h x 5 cm



Chrome/Black finish  
Art. CIR-wifi 198,50€



TECHNICAL DATA and other dimensions p. 198  
ELECTRIC KIT DATA p. 208-209

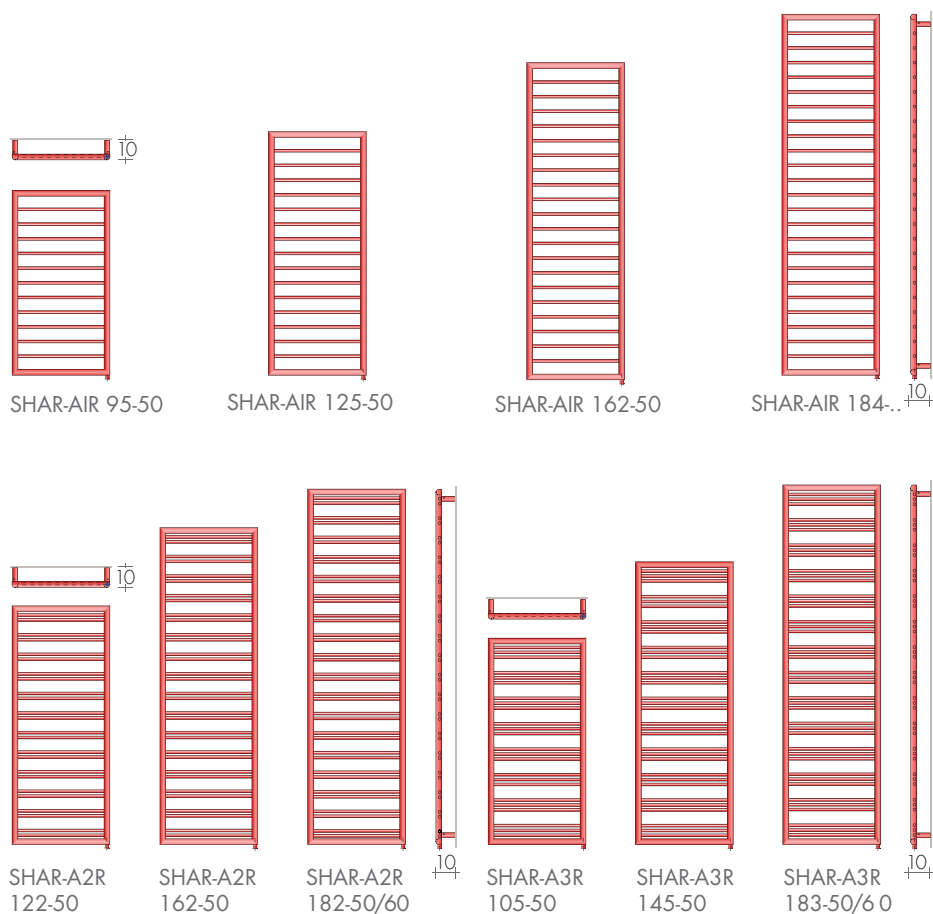

MODEL	H - L cm	Standard white	BREM Colors	BREM Colors	KIT HEATING ELEMENT with:	
		sablé SB 9016 €	+15% €	+25% €	Cable R..E Art. (WV)	Faston R..T Art. (WV) €
SHAR-AIR 95-50		536,70	617,20	670,90	R300IIE	R300IIT 193,80
SHAR-AIR 125-50		585,30	673,10	731,60	R400IIE	R400IIT 195,70
SHAR-AIR 162-50		684,90	787,60	856,10	R500IIE	R500IIT 208,50
SHAR-AIR 184-60		750,50	863,10	938,10	R650IIE	R650IIT 222,90
SHAR-A2R 122-50		665,30	765,10	831,60	R500IIE	R500IIT 208,50
SHAR-A2R 162-50		796,70	916,20	995,90	R650IIE	R650IIT 222,90
SHAR-A2R 182-50		853,10	981,10	1066,40	R800IIE	R800IIT 240,50
SHAR-A2R 182-60		905,70	1041,60	1132,10	R900IIE	R900IIT 255,30
SHAR-A3R 105-50		639,90	735,90	799,90	R500IIE	R500IIT 208,50
SHAR-A3R 145-50		786,80	904,80	983,50	R650IIE	R650IIT 222,90
SHAR-A3R 183-50		945,40	1087,20	1181,80	R800IIE	R800IIT 240,50
SHAR-A3R 183-60		1008,60	1159,90	1260,80	R900IIE	R900IIT 255,30

CHROME HOOK only Shar-A2R e A3R  
(ø 3 x 3,5 cm) p.277 Art. AC n°2 90,90€



HEATING ELEMENT POSITION  
© Vertical Heating Element

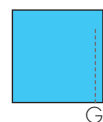

## THERMOSTATS Wi-Fi FOR KIT RE P. 208

## ACCESSORIES FOR

E.H.E. white cable cover  
or radiator color (together)  
Art.CCRE38 ø3/8" 73,40€  
Art.CCRE12 ø1/2" 73,40€



The KIT RT Wi-Fi includes:  
- Thermostat RT (battery)  
- Gateway  
- Built-in receiver

Art. KITRT-wifi 199,80€

Additional receiver  
(up to 6) radiators)

Art. SA868 64,20€



KIT ELY Wi-Fi TOP DESIGN includes:  
- Thermostat with magnetic charging base  
and magnetic plate for wall mounting  
- Gateway a 230V  
- Built-in Receiver

Art. KITELY-wifi 396,10€

Additional receiver: 1 for each electrical radiators  
or split AC (up to 16) Art. SA600 99,10€



TECHNICAL DATA and other dimensions p. 200  
ELECTRIC KIT DATA p. 208-209

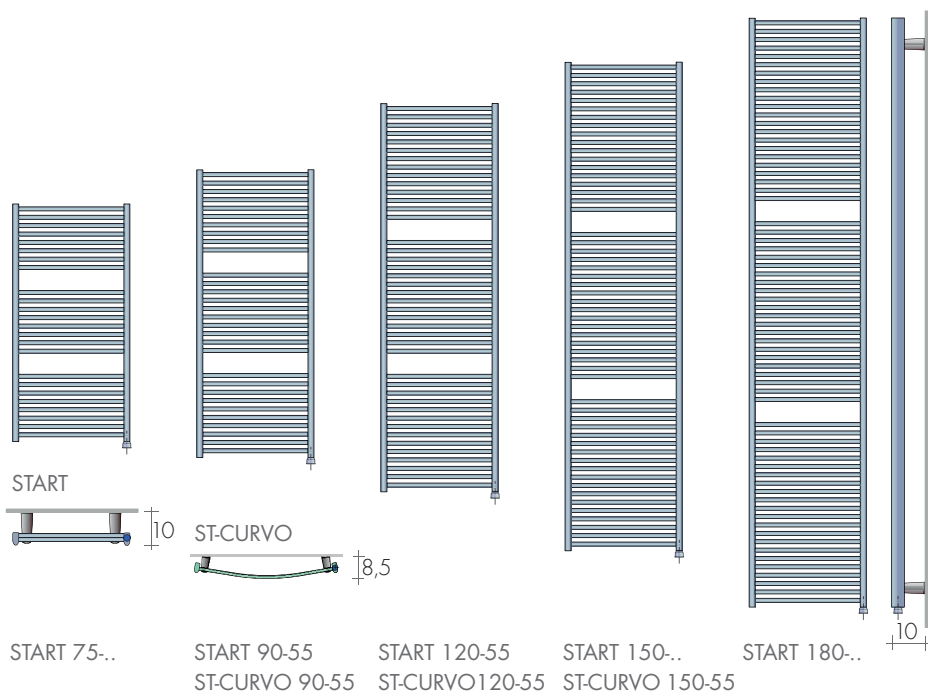

MODEL	H - L cm	Standard white	BREM Colors	BREM Colors	KIT HEATING ELEMENT with:		
		sablé SB 9016 €	+15% €	+25% €	Cable R..E Art. (W)	Faston R..T Art. (W)	€
START 75-45	75-45	418,50	481,30	523,10	R300IIE	R300IIT	193,80
START 75-55	75-55	438,30	504,00	547,90	R400IIE	R400IIT	195,70
START 90-45	90-45	511,80	588,60	639,80	R400IIE	R400IIT	195,70
START 90-55	90-55	533,60	613,60	667,00	R500IIE	R500IIT	208,50
START 120-55	120-55	634,00	729,10	792,50	R650IIE	R650IIT	222,90
START 150-55	150-55	797,10	916,70	996,40	R800IIE	R800IIT	240,50
Slim START 180-35	180-35	854,70	982,90	1068,40	R650IIE	R650IIT	222,90
START 180-45	180-45	876,50	1008,00	1095,60	R900IIE	R900IIT	255,30
START 180-60	180-60	931,30	1071,00	1164,10	R1200IIE	R1200IIT	276,30
ST-CURVO 90-55	90-55	732,80	842,70	916,00	R500IIE	R500IIT	208,50
ST-CURVO 120-55	120-55	851,30	979,00	1064,10	R650IIE	R650IIT	222,90
ST-CURVO 150-55	150-55	1038,70	1194,50	1298,40	R900IIE	R900IIT	255,30

CHROME HOOK  
(ø 3 x 3,5 cm) p.277 Art. AC n°2 90,90€



Chromed models 55 cm wide on request  
Towel heaters height = H - 4 cm

HEATING ELEMENT POSITION  
© Vertical Heating Element

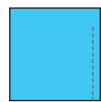

## ELECTRIC VERSIONS

THERMOSTATS IN THE RADIATOR FOR KIT RT P. 209

THERMOSTAT mod. DYP



White with white cable cover  
Art. DYPB 89,60€

ø 7 x 9 x 5 cm



Black with black cable cover  
Art. DYPN 103,40€

REMOTE CONTROL for thermostats DYP

10,8 x 5,3 x 2,3 cm



Art. TIR 41,00€

THERMOSTAT CIRCLE Wi-Fi  
up to 800 W  
heating elements



ø 6 x 8 x 5 cm



Chrome/Black finish  
Art. CIR-wifi 198,50€



TECHNICAL DATA p. 144  
ELECTRIC KIT DATA p. 208-209

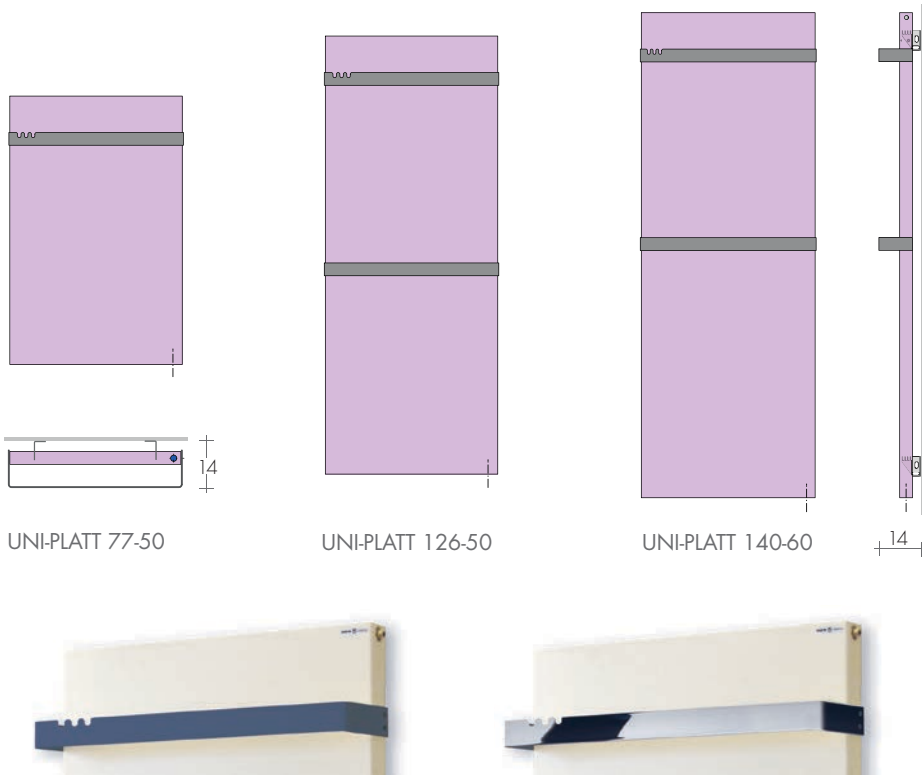

HEATING ELEMENT POSITION  
© Vertical Heating Element

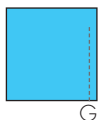

MODEL	H - L cm	Standard white	BREM Colors	BREM Colors	KIT HEATING ELEMENT with:		
		sablé SB 9016 €	+15% €	+25% €	Cable R..E Art. (W)	Faston R..T Art. (W)	€
UNI-PLATT	77-50	745,00	856,80	931,30	R400IIE	R400IIT	195,70
UNI-PLATT	126-50	1021,30	1174,50	1276,60	R650IIE	R650IIT	222,90
UNI-PLATT	140-60	1176,70	1353,20	1470,90	R800IIE	R800IIT	240,50

TOWEL BARS UNI: STANDARD COLORS  
- white sablé SB 9016 - quartz grey SB 7039  
- black sablé SB 9005 - same color as the radiator  
In one paintwork to Brem color list different from the radiator  
Extra Art.CM 52,90€

Chrome towel bar, (each) Extra 88,30€  
Additional chrome towel bar (each) 162,70€

## THERMOSTATS Wi-Fi FOR KIT RE P. 208

## ACCESSORIES FOR

E.H.E. white cable cover  
or radiator color (together)  
Art.CCRE38 ø3/8" 73,40€  
Art.CCRE12 ø1/2" 73,40€



The KIT RT Wi-Fi includes:  
- Thermostat RT (battery)  
- Gateway  
- Built-in receiver

Art. KITRT-wifi 199,80€

Additional receiver  
(up to 6) radiators)

Art. SA868 64,20€



KIT ELY Wi-Fi TOP DESIGN includes:  
- Thermostat with magnetic charging base  
and magnetic plate for wall mounting  
- Gateway a 230V  
- Built-in Receiver

Art. KITELY-wifi 396,10€

Additional receiver: 1 for each electrical radiators  
or split AC (up to 16) Art. SA600 99,10€



design Davide Diliberto

TECHNICAL DATA and other dimensions p. 146  
ELECTRIC KIT DATA p. 208-209

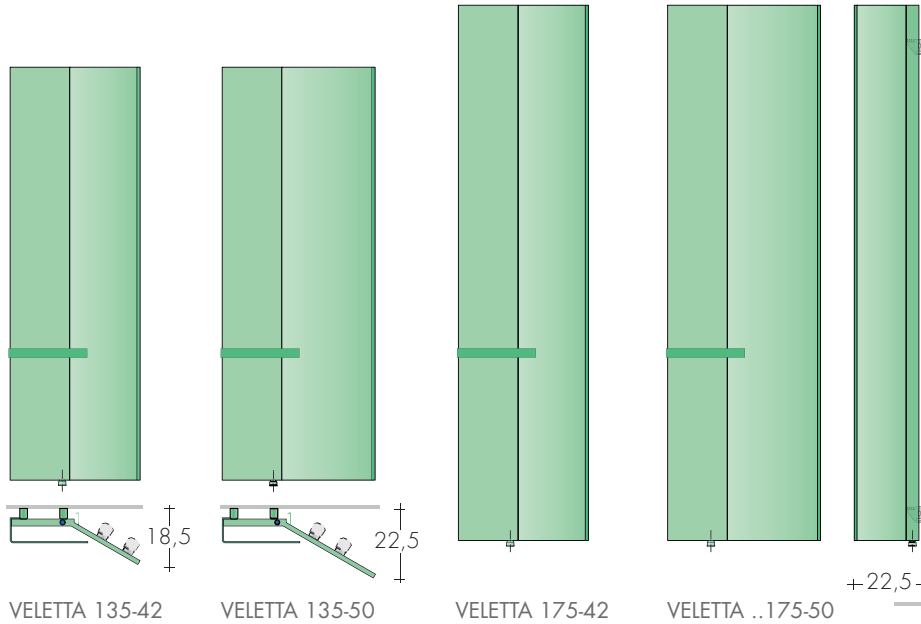

VERSION-SX, on request without extra

MODEL	H - L cm	Standard white	BREM Colors	BREM Colors	KIT HEATING ELEMENT with:		
		sablé SB 9016 €	+15% €	+25% €	Cable®R..E Art. (W)	Faston^R..T Art. (W)	€
VELETTA	135-42	1145,80	1317,70	1432,30	R650IIE	R650IIT	222,90
VELETTA	135-50	1234,40	1419,60	1543,00	R800IIE	R800IIT	240,50
VELETTA	175-42	1212,80	1394,70	1516,00	R900IIE	R900IIT	255,30
VELETTA	175-50	1307,30	1503,40	1634,10	R900IIE	R900IIT	255,30
VELETTA-L	175-50	1571,60	1807,30	1964,50	R1200IIE	R1200IIT	276,30

TOWEL BAR VEL: STANDARD COLORS  
- white sablé SB 9016 - quartz grey SB 7039  
- black sablé SB 9005 - same color as the radiator

In one paintwork to Brem color list different from the radiator  
Extra Art.CM 52,90€

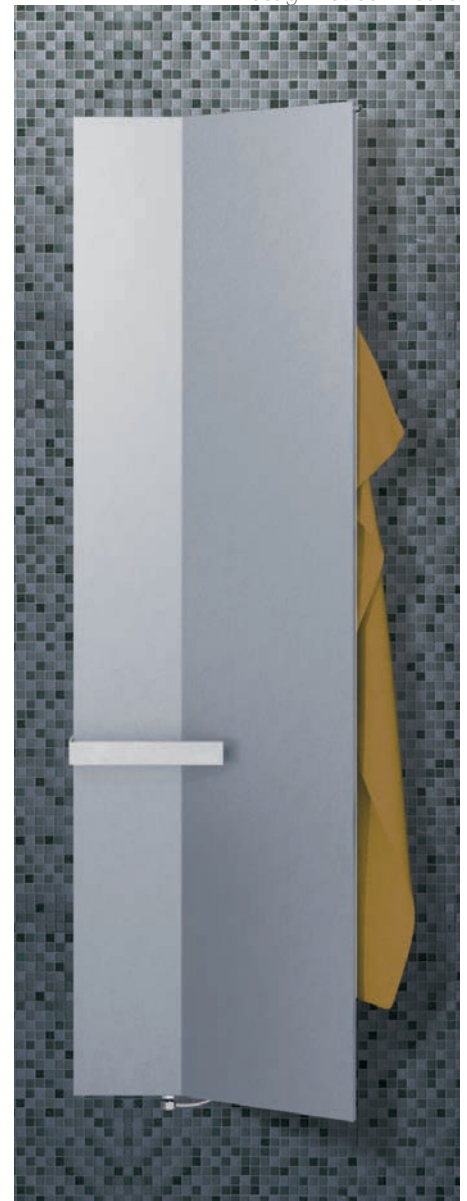

Magnetic KNOBS  
NOT INCLUDED  
page 277  
Art. ARC /POC /HKC  
each 95,50€

HEATING ELEMENT POSITION  
⊙ Vertical Heating Element

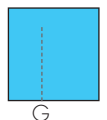

## ELECTRIC VERSIONS

THERMOSTATS IN THE RADIATOR FOR KIT RT P. 209

THERMOSTAT mod. DYP



White with  
white cable cover  
Art. DYPB 89,60€

ø 7 x 9 x 5 cm



Black with  
black cable cover  
Art. DYPN 103,40€

REMOTE CONTROL for thermostats DYP

10,8 x 5,3 x 2,3 cm



Art. TIR 41,00€

THERMOSTAT CIRCLE Wi-Fi  
up to 800 W  
heating elements



ø 6 x 8 h x 5 cm



Chrome/Black finish  
Art. CIR-wifi 198,50€



design Luigi Brembilla

TECHNICAL DATA and other dimensions p. 82  
ELECTRIC KIT DATA p. 208-209

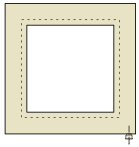

VISION-..48-48  
VISION-..56-56  
VISION-..64-64

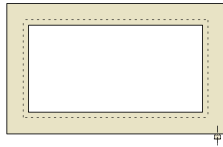

VISION-..48-80



VISION-..64-112

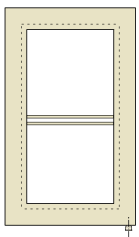

VISION-2ST 80-48

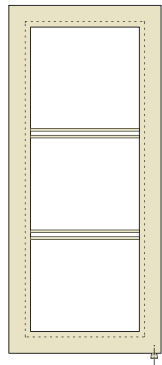

VISION-1ST 128-56

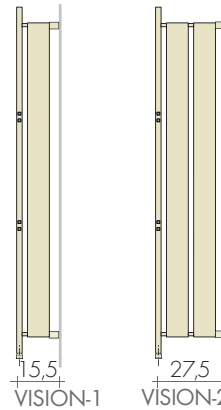

VISION-1

VISION-2



MODEL	H - L cm	Standard white	BREM Colors	BREM Colors	KIT HEATING ELEMENT with:		
		sablé SB 9016 €	+15% €	+25% €	Câble®R..E Art. (W)	Faston®R..T Art. (W)	€
VISION-1	48-48	717,90	825,60	897,40	R300IIE	R300IIT	193,80
VISION-1	56-56	747,60	859,70	934,50	R400IIE	R400IIT	195,70
VISION-1	64-64	810,70	932,30	1013,40	R500IIE	R500IIT	208,50
VISION-1	48-80	822,50	945,90	1028,10	R500IIE	R500IIT	208,50
VISION-1	56-112	895,20	1029,50	1119,00	R650IIE	R650IIT	222,90
VISION-1	64-112	946,00	1087,90	1182,50	R650IIE	R650IIT	222,90
VISION-2	48-80	1138,90	1309,70	1423,60	R650IIE	R650IIT	222,90
VISION-2	64-112	1310,00	1506,50	1637,50	R900IIE	R900IIT	255,30
VISION-2ST	80-48	1312,20	1509,00	1640,30	R650IIE	R650IIT	222,90
VISION-1ST	128-56	1178,20	1354,90	1472,80	R800IIE	R800IIT	240,50

HEATING ELEMENT POSITION  
© Vertical Heating Element

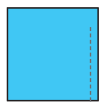

G

## THERMOSTATS Wi-Fi FOR KIT RE P. 208

## ACCESSORIES FOR

E.H.E. white cable cover  
or radiator color (together)  
Art.CCRE38 ø3/8" 73,40€  
Art.CCRE12 ø1/2" 73,40€



The KIT RT Wi-Fi includes:  
- Thermostat RT (battery)  
- Gateway  
- Built-in receiver

Art. KITRT-wifi 199,80€

Additional receiver  
(up to 6) radiators)

Art. SA868 64,20€



KIT ELY Wi-Fi TOP DESIGN includes:  
- Thermostat with magnetic charging base  
and magnetic plate for wall mounting  
- Gateway a 230V  
- Built-in Receiver

Art. KITELY-wifi 396,10€

Additional receiver: 1 for each electrical radiators  
or split AC (up to 16) Art. SA600 99,10€



design Luigi Brembilla

ELECTRIC KIT DATA p. 208-209

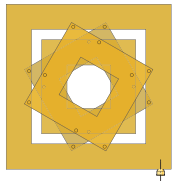
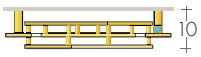

e.ZOOM 50-50

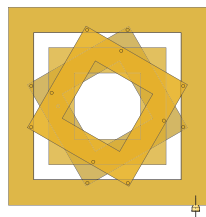

e.ZOOM 60-60

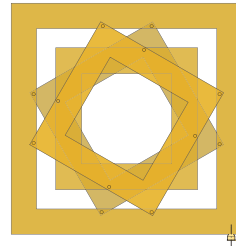

e.ZOOM 70-70

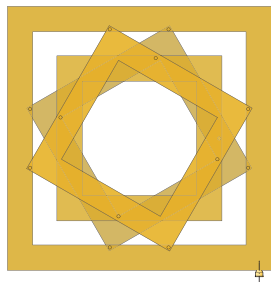

e.ZOOM 80-80

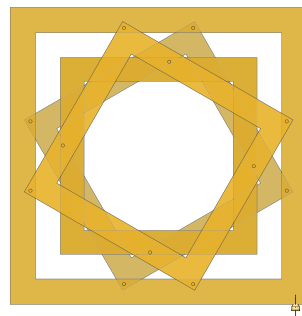

e.ZOOM 90-90

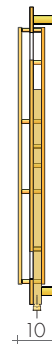

MODEL'25	Standard white		BREM Colors	BREM Colors	KIT HEATING ELEMENT with:		
	H - L cm	sablé SB 9016 €	+15% €	+25% €	Cable R..E Art. (W)	Faston R..T Art. (W)	€
e.ZOOM 50-50	50	878,50	1010,30	1098,10	R400IIE	R400IIT	195,70
e.ZOOM 60-60	60	978,00	1124,70	1222,50	R500IIE	R500IIT	208,50
e.ZOOM 70-70	70	1077,30	1238,90	1346,60	R650IIE	R650IIT	222,90
e.ZOOM 80-80	80	1214,60	1396,80	1518,30	R650IIE	R650IIT	222,90
e.ZOOM 90-90	90	1379,40	1586,30	1724,30	R800IIE	R800IIT	240,50

Prices include the additional manifold

### ON REQUEST HYDRAULIC VERSION

MODEL'25	Standard white		EN 442			▲ ▽ t.c. cm	Depth cm	Weight M Kg	Volume V dm³
	H-L cm	sablé SB 9016 €	Δt 50 K watt	Δt 40 K watt	Δt 30 K watt				
ZOOM 50-50	50	774,00	358	270	188	19	11,5	7,4	2,2
ZOOM 60-60	60	873,50	463	350	244	19	11,5	9,0	2,7
ZOOM 70-70	70	972,80	577	436	304	19	11,5	12,1	3,6
ZOOM 80-80	80	1110,10	681	514	358	19	11,5	14,3	4,3
ZOOM 90-90	90	1274,90	804	607	423	19	11,5	16,8	5,0

Mixed Version to estimate

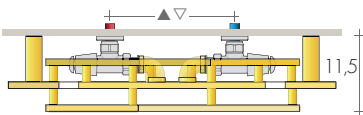

REVERSE FITTINGS  
REG ø1/2" ▲ ▽ 19 cm at the rear



HEATING ELEMENT POSITION  
© Vertical Heating Element

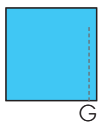

## ELECTRIC VERSIONS

## THERMOSTATS IN THE RADIATOR FOR KIT RT P. 209

### THERMOSTAT mod. DYP



White with  
white cable cover  
Art. DYPB 89,60€

ø 7 x 9 x 5 cm



Black with  
black cable cover  
Art. DYPN 103,40€

### REMOTE CONTROL for thermostats DYP

10,8 x 5,3 x 2,3 cm



Art. TIR 41,00€

### THERMOSTAT CIRCLE Wi-Fi up to 800 W heating elements



ø 6 x 8 x 5 cm



Chrome/Black finish  
Art. CIR-wifi 198,50€





# VALVOLE & ACCESSORI



VALVOLE 266

VALVOLE TON 268

KIT VALVOLE TON 269

VALVOLE MINI 270

VALVOLE QUADRA 271

VALVOLE CYL 272

KIT VALVOLE CYL 273

VALVOLE REMOTE 274

SISTEMI WiFi 275

ESECUZIONI SPECIALI 276

MENSOLE 276

ACCESSORI 277

ALLACCIAMENTI 278



# VALVOLE CROMO

PREZZI DAL 01.03.2026 +5%

BREM propone, in sostituzione della valvola e del detentore tradizionali, un solo corpo valvola a semplice regolazione da usare anche come detentore.

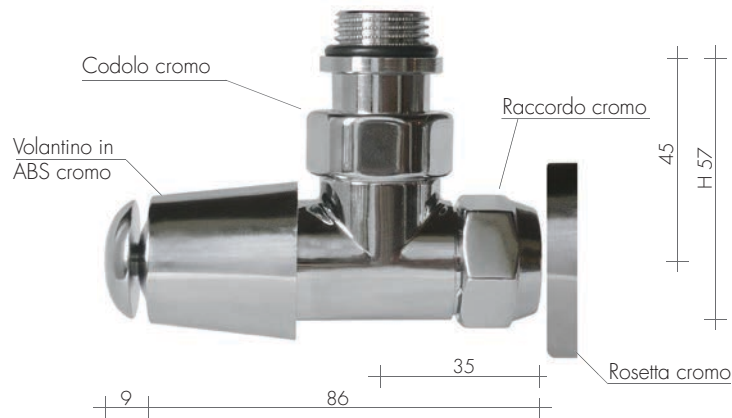

Le valvole BREM sono complete di:  
 - codolo cromato o-ring  $\varnothing$  3/8" o  $\varnothing$  1/2"  
 - raccordo cromato con o-ring  
 - rosetta copriforo cromata  $\varnothing$  41x6,5 mm  
 - testa termostatica (per le valvole termostatiche)

A richiesta: copritubo inox da dividere

## COMPONENTI VALVOLE

### CODOLI CROMATI

$\varnothing$  3/8" -  $\varnothing$  1/2"

per allacciamento al calorifero

Attacco 3/8" Art. CVL38 9,30€  
 Attacco 1/2" Art. CVL12 9,30€



### RACCORDI CROMATI (24F19)

per allacciamento all'impianto:



Raccordo per tubo multistrato  $\varnothing$ 10-14,  $\varnothing$ 12-16,  $\varnothing$ 14-18,  $\varnothing$ 16-20 Art. RM.. 8,50€



Raccordo per tubo rame  $\varnothing$ 10-12-14-15-16-18 Art. RR.. (R10 - R12 - R14 - R15..) 6,30€

### KIT RACCORDI con INSERTI

Raccordi e rosette cromo per 2 valvole (multistrato  $\varnothing$  16 e rame  $\varnothing$  12 e 14) Art. RK 35,40



Rosetta cromata

Raccordo con inserti per multistrato  $\varnothing$  16

inserti per rame  $\varnothing$  12 e  $\varnothing$  14

### KIT RACCORDI per coppia Valvole Colorate

n.2 codoli,  
 n.2 raccordi  
 n.2 rosette



- Finitura NICKEL spazzolato  
 Supplemento Art.RN 28,20€

- Finitura BRONZO Supplem. Art.RB 26,40€

- Finitura ORO Supplemento Art.RO 52,80€

### ECCENTRICI CROMATI $\varnothing$ 3/8"-1/2"

Adattatori da montare tra valvola e calorifero per variare l'interasse attacchi da 1 a 6 cm

Art. EC1 Eccentrico di 1 cm 13,20€

Art. EC2 Eccentrico di 2 cm 18,00€

Art. EC3 Eccentrico di 3 cm 20,80€

Specificare all'ordine se da 1/2" o 3/8"



## ACCESSORI VALVOLE

ROSETTA copriforo cromata  $\varnothing$  41 x 6,5 mm per tubi  $\varnothing$  10-12-14-15 ( $\varnothing$  48 per 16-1/2" (indicare diametro) Art. RC.. 3,10€



### COPRITUBI ATTACCHI

Tubo inox lucido, lungo 10 cm, da infilare sui tubi degli attacchi  $\varnothing \leq 16$ mm e dividere in due parti a misura utilizzando la rosetta per coprire il taglio.

$\varnothing$  interno 15 mm Art. CA15 10,30€

$\varnothing$  interno 16 mm Art. CA16 10,30€

per KIT Valvole Art. CA18 11,50€



KIT COPRITUBO MONOTUBO int. att. 38mm Rosetta 5x10cm, e n° 2 tubi  $\varnothing$  16 o 20mm L=7cm

Art. KM16 60,80€

Art. KM20 63,50€



### TESTA TERMOSTATICA CROMO

Testa termostatica cromo con sensore a liquido (solo per valvole termostaticizzabili).

Art. STC 49,20€



### TESTA TERMOSTATICA in finiture galvaniche

Testa termostatica in metallo con sensore a liquido (solo per valvole termostaticizzabili).

- Colore BIANCO, NERO MATT  
 Art. STB/STN cad. 56,70€

- Finitura NICKEL SPAZZOLATO  
 Art. STK cad. 72,90€

- Finitura BRONZO Art. STR cad. 70,40€

- Finitura ORO Art. STO cad. 83,00€



# FINITURE SPECIALI

## VALVOLE - ACCESSORI

PREZZI DAL 01.03.2026 **+5%**

VALVOLA  
TON



### FINITURA FOGLIA DORATA

Valvola TON e QUADRA in foglia DORATA.  
Codolo  $\varnothing$  1/2" o 3/8", raccordo multistrato  $\varnothing$  16,  
rame  $\varnothing$  12 e 14 (altre misure a preventivo), rosetta  
con finitura oro

Supplemento cad. Art. VFO 88,20€

VALVOLA  
QUADRA



### FINITURA FOGLIA D'ARGENTO

Valvola TON e QUADRA in foglia ARGENTO.  
Codolo  $\varnothing$  1/2" o 3/8", raccordo multistrato  $\varnothing$  16,  
rame  $\varnothing$  12 e 14 (altre misure a preventivo) e rosetta  
con finitura nickel spazzolato

Supplemento cad. Art. VFA 88,20€



### FINITURA ORO

Valvola TON e QUADRA, codolo  $\varnothing$  1/2" o 3/8",  
raccordo multistrato  $\varnothing$  16, rame  $\varnothing$  12 e 14 (altre  
misure a preventivo) e rosetta con finitura oro

Supplemento soggetto a variazione cad.  
Art. VOR 70,70€



### FINITURA BRONZO

Valvola TON e QUADRA, codolo  $\varnothing$  1/2" o 3/8",  
e raccordo multistrato  $\varnothing$  16, rame  $\varnothing$  12 e 14 (altre  
misure a preventivo) con finitura bronzo. Rosetta  
color bronzo.

Supplemento cad. Art. VBZ 31,60€



### FINITURA NICKEL SPAZZOLATO

Valvola TON e QUADRA, codolo  $\varnothing$  1/2" o 3/8",  
raccordo multistrato  $\varnothing$  16, rame  $\varnothing$  12 e 14 (altre  
misure a preventivo) e rosetta con finitura nickel  
spazzolato

Supplemento cad. Art. VNS 33,40€



A richiesta:  
VALVOLA CYL IN FINITURE SPECIALI

# VALVOLA TON CROMO

PREZZI DAL 01.03.2026 **+5%**

Valvola a semplice regolazione, utilizzabile anche come detentore, con codolo, raccordo e rosetta

Valvola con testa termostatica cromata, codolo, raccordo e rosetta copriforo

## VALVOLA TON a SQUADRA.



Art. VSM.. 54,90€  
Art. VSR.. 52,70€  
Art. VSF 50,80€



## VALVOLA TON a SQUADRA TERMOSTATICA



Art. TSM.. 104,10€  
Art. TSR.. 101,90€  
Art. TSF 99,00€

## VALVOLA TON DIRITTA



Art. VDM.. 60,50€  
Art. VDR.. 58,30€  
Art. VDF 56,10€

VALVOLA TON  
Volantino ø 28-34 /L 95 /H 57mm

## VALVOLA TON DIRITTA TERMOSTATICA



Art. TDM.. 109,70€  
Art. TDR.. 107,50€  
Art. TDF 103,50€

### LEGENDA VALVOLE:

VS.. TON Squadra	RACCORDI per tubi:
VD.. TON Diritta	M Multistrato
VR.. TON Reversa	R Rame
L.. TON Laterale	F Attacco Ferro ø 1/2"
T.. Termostatica	INDICARE il ø del tubo

## VALVOLA TON REVERSA



Art. VRM.. 54,90€  
Art. VRR.. 52,70€  
Art. VRF 50,80€

Valv. TON Squadra raccordo Rame  
Esempio d'ordine: ART. VSR14 tubo ø14

## VALVOLA TON REVERSA TERMOSTATICA



Art. TRM.. 104,10€  
Art. TRR.. 101,90€  
Art. TRF 99,00€

## VALVOLA TON comando LATERALE Indicare sempre S o D.



Art. L.M.. 61,10€  
Art. L.R.. 58,90€  
Art. L.F 56,20€

## VALVOLA TON comando LATERALE TERMOSTATICA Versione S



Art. LTSM.. 110,30€  
Art. LTSR.. 108,10€  
Art. LTSF 105,50€

VALVOLA TON MISTA con attacco ø1/2" per Resistenza Elettrica, utilizzabile con le valvole a squadra o con comando laterale.



Art. LXDM.. 96,00€  
Art. LXDR.. 93,80€

### COPRITUBI ATTACCHI

Tubo inox lucido, lungo 10 cm, da infilare sui tubi degli attacchi ø ≤ 16mm e dividere in due parti a misura utilizzando la rosetta per coprire il taglio

ø 15 mm	Art. CA15 10,30€
ø 16 mm	Art. CA16 10,30€



## VALVOLA TON comando LATERALE TERMOSTATICA Versione D



Art. LTDM.. 110,30€  
Art. LTDR.. 108,10€  
Art. LTDF 105,50€

# KIT VALVOLE TON NICHELATE

KIT VALVOLE TON comando LATERALE, a semplice regolazione, corpi nichelati volantini cromo.



Art. KVLN 97,00€

Il KIT comprende 2 valvole a semplice regolazione o una valvola termostatica ed una a semplice regolazione, codoli, rosette copriforo ø 48 e raccordi per tubo multistrato ø16 e inserti tubo rame ø12 e ø14

KIT VALVOLE TON comando LATERALE testa Termostatica, corpi nichelati volantino cromo.



Art. KTLND 143,80€

# KIT VALVOLE TON CROMO

PREZZI DAL 01.03.2026 **+5%**

## KIT valvole TON

Il KIT comprende 2 valvole a semplice regolazione con codoli, rosette copriforo  $\varnothing 48$  e raccordi per tubo multistrato  $\varnothing 16$  e 4 inserti tubo rame  $\varnothing 12$  e 14



Raccordo con inserti per multistrato  $\varnothing 16$



inserti per rame  $\varnothing 14$



inserti per rame  $\varnothing 12$

## KIT TON con Termostatica

Il KIT comprende una valvola termostatica e una semplice, codoli, rosette  $\varnothing 48$ , raccordi, inserti per tubo multistrato  $\varnothing 16$  e inserti per rame  $\varnothing 12$  e 14



KIT VALVOLE TON a SQUADRA  
Art. KVS 127,00€

KIT TON a SQUADRA con Testa TERMOSTATICA Art. KTS 176,20€



KIT VALVOLE TON DIRITTE  
Art. KVD 138,20€

KIT TON DIRITTA con Testa TERMOSTATICA Art. KTD 187,50€



KIT VALVOLE TON REVERSE  
Art. KVR 127,00€

KIT TON REVERSA con Testa TERMOSTATICA Art. KTR 176,20€



KIT VALVOLE TON comando LATERALE  
Art. KVL 139,20€

KIT TON comando LATERALE con Testa TERMOSTATICA  
Versione S Art. KTL 188,60€  
Versione D Art. KTLD 188,60€



Art. KTLD

## COPRITUBI ATTACCHI x KIT

Tubo inox lucido, lungo 10 cm, da infilare sui tubi degli attacchi  $\varnothing \leq 16$ mm e dividere in due parti a misura utilizzando la rosetta per coprire il taglio per KIT Valvole Art. CA18 11,50€



## KIT VALVOLE TON PER VERSIONI MISTE



Art. KLXD

KIT VALVOLE TON comando LATERALE S e MISTA D  $\varnothing 1/2"$  per Resistenza elettrica  
Art. KLXD 174,30€

KIT TON comando LATERALE con Testa Termostatica e MISTA D  
Art. KTLXD 223,60€



Art. KTLXD

# VALVOLA MINI CROMO

PREZZI DAL 01.03.2026 **+5%**

## Modello MINI

Valvola a semplice regolazione utilizzabile anche come detentore con codolo, rosetta copriforo

### VALVOLA MINI A SQUADRA

Art. MSM.. 48,80€  
Art. MSR.. 46,60€



### VALVOLA MINI

Volantino ø 24 / 71,5 / H 57mm

### VALVOLA MINI DIRITTA

Art. MDM.. 54,70€  
Art. MDR.. 52,60€



Valvola MINI, dal design essenziale e con dimensioni estremamente ridotte, è dotata di regolazione semplice ed efficace.

MS.. Mini a Squadra      RACCORDI per Tubo:  
MD.. Mini Diritta        M Multistrato  
                                     R Rame  
INDICARE il ø del tubo

Valvola Mini a Squadra      raccordo Multistrato  
Esempio d'ordine: Art. MS M12-16      tubo ø12-16

## KIT Valvole MINI

Il KIT comprende 2 valvole con codoli, rosette ø 48 raccordi e inserti multistrato ø16 e rame ø12 e 14



### KIT VALVOLE MINI a SQUADRA

Art. KMS 114,80€



### KIT VALVOLE MINI DIRITTE

Art. KMD 126,70€



### COPRITUBI ATTACCHI

Tubo inox lucido, lungo 10 cm da dividere a misura, infilare sui tubi degli attacchi (ø 12, 14, 16 mm) utilizzando la rosetta con adattatori per coprire il taglio  
ø 15 mm                      Art. CA15 10,30€  
ø 16 mm                      Art. CA16 10,30€  
per KIT Valvole              Art. CA18 11,50€

# VALVOLA MINI BIANCA

## MINI BIANCA a SQUADRA

### VALVOLA MINI BIANCA A SQUADRA

Valvola verniciata bianca di serie, completa di codolo, rosetta e raccordi cromati.

Art. MSBM.. 48,80€ Ral 9016  
Art. MSBR.. 46,60€ Ral 9016



### VALVOLA MINI BIANCA A SQUADRA

La valvola MINI a SQUADRA è fornita nel colore bianco (codolo, raccordo e rosetta cromati)

## KIT Valvole MINI BIANCA a squadra



KIT VALVOLE MINI BIANCHE A SQUADRA n°2 Valvole MINI verniciate bianche di serie con codoli, rosette tonde e raccordi cromati (con inserti multistrato ø16 e rame ø12 e ø14)

Art. KMSB 114,80€ Ral 9016

KIT Raccordi NICKEL spazzolato per n°2 valvole supplemento Art. RN 28,20€



# VALVOLA QUADRA CROMO

PREZZI DAL 01.03.2026 +5%

## Valvola QUADRA

Valvola a semplice regolazione utilizzabile anche come detentore con codolo, rosetta copriforo

### VALVOLA QUADRA A SQUADRA



Art. QSM.. 74,80€  
Art. QSR.. 72,60€

### VALVOLA QUADRA DIRITTA



Art. QDM.. 79,40€  
Art. QDR.. 77,20€

### VALVOLA QUADRA REVERSA



Art. QRM.. 74,80€  
Art. QRR.. 72,60€

### VALVOLA QUADRA comando LATERALE

Indicare sempre S o D.



Art. QL..M.. 74,80€  
Art. QL..R.. 72,60€



### VALVOLA QUADRA

Volantino 26x26 / 86 / H 57mm

La valvola QUADRA, dal design ricercato per l'abbinamento a forme geometriche squadrate.

QS.. QUADRA Squadra RACCORDI per Tubo:  
QD.. QUADRA Diritta M Multistrato  
QR.. QUADRA Reversa R Rame  
QL.. QUADRA Laterale INDICARE il ø del tubo

Valv. Quadra Reversa raccordo Rame  
Esempio d'ordine: Art. QR RT4-tubo rame ø 14

## KIT Valvole QUADRA

Il KIT comprende 2 valvole con codoli, rosette ø 48 raccordi e inserti multistrato ø16 e rame ø12 e 14



### KIT VALVOLE QUADRA a SQUADRA



Art. KQS 166,80€

### KIT VALVOLE QUADRA DIRITTE



Art. KQD 176,00€

### KIT VALVOLE QUADRA REVERSE



Art. KQR 166,80€

### KIT VALVOLE QUADRA comando LATERALE



Art. KQL 177,10€

# VALVOLA QUADRA COLORATA

## Mod. QUADRA COLORATA

### VALVOLE QUADRA COLORATA

Valvole verniciate con il radiatore in una tinta della tabella colori BREM. con raccordi cromati supplemento n°2 pz. Art. VC 49,50€



## KIT QUADRA COLORATE



### KIT VALVOLE QUADRA COLORATE

- n°2 Valvole verniciate con il radiatore in una tinta della tabella BREM, raccordi, codoli e rosette ø 48 cromo; inserti multistrato ø16 e rame ø12 e 14 Colore tabella BREM supplemento Art. VC 49,50€

KIT Raccordi NICKEL spazzolato per n°2 valvole supplemento Art. RN 28,20€



# VALVOLA CYL CROMO TERMOSTATIZZABILE

PREZZI DAL 01.03.2026 +5%

Valvola termostattizzabile con attacco per teste termostatiche manuali o elettroniche.

Valvola e detentore in finitura cromo di serie; o verniciati in una tinta della tabella colori BREM.

Codoli, raccordi e rosette cromo di serie; a richiesta in finitura nichel spazzolato.



## LEGENDA VALVOLE:

CS.. CYL a Squadra  
CD.. CYL Diritta  
CR.. CYL Reversa  
CL.. CYL Laterale

## LEGENDA DETENTORI:

CYS.. Detentore CYL a Squadra  
CYD.. Detentore CYL Diritto  
CYR.. Detentore CYL Reverso  
CYL.. Detentore CYL Laterale

## RACCORDI per tubi:

M Multistrato  
R Rame

INDICARE il  $\varnothing$  del tubo

Valv. CYL Squadra raccordo Rame

Esempio d'ordine: ART. CSR14-tubo  $\varnothing$ 14

## VALVOLA CYL

Volantino  $\varnothing$  31 / 88 / H 57mm

## DETTENTORE CYL

Volantino  $\varnothing$  26 / 72 / H 57mm

Valvole e detentori complete di raccordi e rosette.

## VALVOLA TERMOSTATIZZABILE CYL a SQUADRA



Art. CSM.. 73,10€  
Art. CSR.. 70,90€

## DETTENTORE CYL a SQUADRA.



Art. CYSM.. 48,50€  
Art. CYSR.. 46,30€

## VALVOLA a SQUADRA TERMOSTATICA



Art. TSM.. 104,10€  
Art. TSR.. 101,90€

## VALVOLA TERMOSTATIZZABILE CYL DIRITTA



Art. CDM.. 77,10€  
Art. CDR.. 74,90€

## DETTENTORE CYL DIRITTO



Art. CYDM.. 52,70€  
Art. CYDR.. 50,50€

## VALVOLA DIRITTA TERMOSTATICA



Art. TDM.. 109,70€  
Art. TDR.. 107,50€

## VALVOLA TERMOSTATIZZABILE CYL REVERSA



Art. CRM.. 73,10€  
Art. CRR.. 70,90€

## DETTENTORE CYL REVERSO



Art. CYRM.. 48,50€  
Art. CYRR.. 46,30€

## VALVOLA REVERSA TERMOSTATICA



Art. TRM.. 104,10€  
Art. TRR.. 101,90€

## VALVOLA TERMOSTATIZZABILE CYL comando LATERALE.

Indicare sempre S o D.



Art. CL..M.. 79,00€  
Art. CL..R.. 76,80€

## DETTENTORE CYL comando LATERALE

Indicare sempre versione S o D.

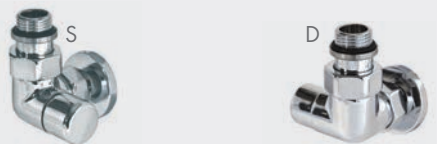

Art. CYL..M.. 54,30€  
Art. CYL..R.. 52,10€

## VALVOLA comando LATERALE TERMOSTATICA

Indicare sempre versione S o D.



Art. LT..M.. 110,30€  
Art. LT..R.. 108,10€

## COPRITUBI ATTACCHI



Tubo inox lucido, lungo 10 cm da dividere a misura, infilare sui tubi degli attacchi ( $\varnothing$  12, 14, 16 mm) utilizzando la rosetta con adattatori per coprire il taglio  $\varnothing$  15 mm  
 $\varnothing$  15 mm Art. CA15 10,30€  
 $\varnothing$  16 mm Art. CA16 10,30€  
 per KIT Valvole Art. CA18 11,50€

## DETTENTORE CYL MISTO per Resistenza $\varnothing$ 1/2"

Utilizzabile in coppia con le valvole a squadra o con comando laterale. Indicare sempre versione S o D.

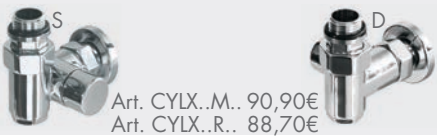

Art. CYLX..M.. 90,90€  
Art. CYLX..R.. 88,70€

## KIT COPRITUBO MONOTUBO int. att. 38mm

Rosetta mm100x50, e n° 2 tubi  $\varnothing$  16 o  $\varnothing$  20 lung. 70mm

Art. KM16 63,80€  
Art. KM20 66,70€



## VALVOLA CYL COLORI BREM

Le valvole ed i detentori CYL possono essere forniti in KIT verniciati in una tinta della tabella colori BREM, (codoli, raccordi e rosette cromo)  
 Kit Valvole o Bitubo supplemento Art. VC 49,50€



Valvola e detentore CYL comando Laterale verniciati; codoli, raccordi e rosette cromo  
 +supplemento colore + suppl. Nickel spazzolato



KIT Raccordi NICKEL spazzolato per n°2 valvole  
 supplemento Art. RN 28,20€

# KIT VALVOLE CYL CROMO

PREZZI DAL 01.03.2026 +5%

## KIT valvole CYL TERMOSTATIZZABILI

Il KIT comprende valvola termostattizzabile e detentore con codoli, rosette copriforo  $\varnothing 48$  e raccordi per tubo multistrato  $\varnothing 16$  e 4 inserti tubo rame  $\varnothing 12$  e  $\varnothing 14$



Raccordo con inserti per multistrato  $\varnothing 16$



inserti per rame  $\varnothing 14$



inserti per rame  $\varnothing 12$



KIT valvola CYL TERMOSTATIZZABILE a SQUADRA Art. KCS 138,80€

KIT valvola CYL TERMOSTATICA a SQUADRA Art. KCTS 166,60€



KIT valvola CYL TERMOSTATIZZABILE DIRITTA Art. KCD 147,00€

KIT valvola CYL TERMOSTATICA DIRITTA Art. KCTD 174,80€



KIT valvola CYL TERMOSTATIZZABILE REVERSA Art. KCR 138,80€

KIT valvola CYL TERMOSTATICA REVERSA Art. KCTR 166,60€



Art. KCL

KIT valvola CYL TERMOSTATIZZABILE comando LATERALE Art. KCL 150,50€  
versione D Art. KCLD 150,50€

KIT valvola CYL TERMOSTATICA comando LATERALE Art. KCTL 178,30€  
versione D Art. KCTLD 178,30€



Art. KCLD



Art. KCTL



Art. KCTLD



KIT valvola MONOTUBO CYL Termostattizzabile  $\Delta \nabla 38$ mm (sonda  $\varnothing 10$ mm L 45 cm), e deviatore di flusso per invertire mandata e ritorno Art. KCM 162,90€

sonda cm 70 9,00€  
sonda cm 100 12,60€

KIT valvola CYL MONOTUBO  $\Delta \nabla 38$ mm TERMOSTATICA Art. KTM 190,70€



KIT VALVOLA BITUBO CYL Termostattizzabile a SQUADRA  $\Delta \nabla 5$  cm Art. KCB 158,80€

KIT VALVOLA BITUBO CYL TERMOSTATICA a SQUADRA  $\Delta \nabla 5$  cm Art. KTB 186,60€



## KIT VALVOLE CYL PER VERSIONI MISTE



Art. KCLXD

KIT valvola CYL TERMOSTATIZZABILE LATERALE detentore Misto Art. KCLXS 187,10€  
Versione D Art. KCLXD 187,10€

KIT valvola CYL TERMOSTATICA LATERALE detentore Misto Art. KCTLXS 214,90€  
Versione D Art. KCTLXD 214,90€



Art. KCLXS

# VALVOLE REMOTE

PREZZI DAL 01.03.2026 +5%

## GRUPPO VALVOLE REMOTE

Il Gruppo comprende n.2 valvole a incasso in ottone grezzo da fissare sulla staffa da murare; volantini, rosette e raccordi cromo con inserti per tubi MULTISTRATO o tubi RAME (indicare ø del tubo)



**GRUPPO VALVOLE REMOTE TON**  
comprende di valvole con rosette, codoli e raccordi (indicare ø del tubo)

MULTISTRATO Art. VGM.. 146,30€  
RAME Art. VGR.. 144,10€

**GRUPPO VALVOLE REMOTE TON con testa TERMOSTATICA** e raccordi completi (indicare ø del tubo)

MULTISTRATO Art. VGTM..195,50€  
RAME Art. VGTR.. 193,30€



**GRUPPO Valvole REMOTE CYL con valvola TERMOSTATIZZABILE**, volantini, rosette, codoli e raccordi cromo (indicare ø del tubo)

MULTISTRATO Art. CGM.. 190,50€  
RAME Art. CGR.. 186,10€

**GRUPPO Valvole REMOTE CYL TERMOSTATICA** con raccordi completi (indicare ø del tubo)

MULTISTRATO Art. CGTM..206,20€  
RAME Art. CGTR.. 201,80€



**GRUPPO VALVOLE REMOTE QUADRA** a incasso con valvole rosette e 2 raccordi (indicare ø del tubo)

MULTISTRATO Art. QGM..161,30€  
RAME Art. QGR.. 159,20€

Verniciatura colori Brem suppl. Art. VC 49,50€

Il Gruppo Valvole Remote viene collocato in un punto poco visibile. Con il gruppo con testa termostatica la posizione deve essere sensibile alla variazione della temperatura ambiente.



## KIT GRUPPI VALVOLE REMOTE

Il Kit comprende 2 valvole in ottone grezzo da fissare sulla staffa da murare con volantini, rosette e raccordi cromo con inserti per tubi multistrato ø 16 e tubi rame ø12 e 14 mm



Valvola termostatica TON

**KIT GRUPPO Valvole TON**  
a regolazione semplice Art. KVG 163,50€

**KIT GRUPPO Valvole TON con Testa Termostatica**  
Art. KVGT 212,80€



Valvole Remote CYL

**KIT GRUPPO Valvole CYL Termostattabile**  
Art. KCG 207,70€

**KIT GRUPPO Valvole CYL con Testa Termostatica**  
Art. KCGT 223,40€

Verniciatura colori Brem suppl. Art. VC 49,50€



Valvole Remote QUADRA

**KIT GRUPPO Valvole QUADRA**  
a regolazione semplice Art.KQG 178,60€

Verniciatura colori Brem suppl. Art. VC 49,50€

## ATTACCHI SUL RETRO DEL RADIATORE

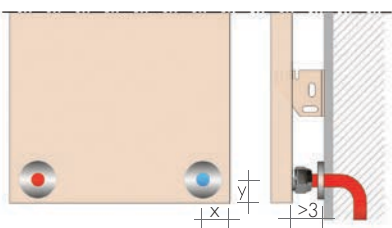

Brem propone attacchi costituiti da manicotti filettati (ø 24 F19) saldati sul retro del calorifero.

Art. REM 37,60€

Il collegamento dei tubi dal gruppo remoto (fino a 6 m.), si esegue avvitando i 2 raccordi cromati ø16 multistrato o ø12-14 rame, completi di rosette, direttamente al radiatore.

Art. RK 35,40€

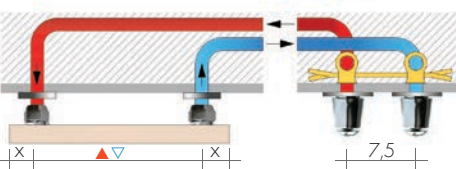

# SISTEMA wifi AVANZATO

## TERMOSTATI CONFORMI NORME ECODESIGN

PREZZI DAL 01.03.2026 **+5%**

Non importa dove ti trovi, la tua casa può essere sempre a portata di mano. Puoi controllare i

tui dispositivi con la nostra applicazione gratuita. Con pochi semplici clic puoi regolare

tutti i parametri del tuo spazio abitativo per soddisfare le esigenze tue e della famiglia.

### GATEWAY WiFi

Il Gateway Avanzato GTAD, consente di comandare diversi apparecchi: termostati, valvole, split A.C., elettrodomestici.

- Indicazione LED
- Collega tutti i prodotti SALUS Smart Home all'app Salus Premium Lite
- Connessione via cavo e WiFi (via cavo necessaria per impostare quella WiFi)
- Montaggio su tavolo o parete
- Comunicazione ZigBee senza fili
- 5 anni di garanzia

### GATEWAY

Art. GT-AD 227,30€

Gateway  
ø 9 x 5,5 cm



### V-SMART

La testa termostatica V-SMART per la valvola dei caloriferi offre un funzionamento silenzioso, funzionalità avanzate e connettività Zigbee 3.0, ideale per una gestione efficiente del riscaldamento.

- Funziona in modo autonomo o in coppia con un termostato ambiente.
- Interfaccia intuitiva con manopola di selezione e display LCD.
- Supporta 4 orientamenti del display per installazioni flessibili del radiatore.
- Adattatori intercambiabili (M30, M28, RA)

### TERMOSTATO WiFi

cablato da SEMINCASSO  
Art. TWIB 191,40€



8,6 x 8,6 x 2,8 cm

- Sporgenza dal muro 1 cm
- Protocollo ZigBee
- Alimentazione 230V
- Ampio schermo LCD
- Sensore di umidità
- Programmabile: giornaliero, settimanale o 5/2
- Isteresi ± 0,5 e 0,25°C
- ERP di classe IV
- Uscite a contatto pulito o a contatto 230V
- ITLC (compensazione del carico della temperatura)
- 2 contatti per sensore di presenza
- Relè interno
- Potere di interruzione: 3 (1) A
- Controllo dall'app gratuita Salus smart home
- Modalità Riscaldamento/Raffreddamento
- Funziona con GT-AD o in modo indipendente

Per il riscaldamento di impianti autonomi o centralizzati con gestione autonoma

### RISCALDAMENTO CENTRALIZZATO



Art. V-SMART 98,30€

ø 5,3 x 9,2 cm

Testina termostatica per caloriferi

### RISCALDAMENTO IDRAULICO AUTONOMO



Art. TWIB 191,40€

Termostato da incasso



Art. V-SMART 98,30€

Testina termostatica

### RISCALDAMENTO CENTRALIZZATO E RADIATORI ELETTRICI



Art. V-SMART 98,30€

ø 5,3 x 9,2 cm

Testina termostatica per caloriferi

### ELY ADVANCE

Art. ELY-AD 196,40€

Termostato da 1 a 16 ricevitori



Art. SA600 91,80€

Ricevitore avanzato per radiatori elettrici/split/accessori (1 pz per ogni apparecchio)

4,5 x 4,5 x 2 cm



### RISCALDAMENTO IDRAULICO AUTONOMO E RADIATORI ELETTRICI



Art. TWIB 191,40€

Termostato da incasso



Art. V-SMART 98,30€

Testina termostatica

### ELY ADVANCE

Art. ELY-AD 196,40€

Termostato fino 16 ricevitori



Art. SA600 91,80€

Ricevitore avanzato



### ACCESSORI OPZIONALI

Ricevitore a incasso supplementare per radiatori elettrici e split AC: 1 per ogni apparecchio elettrico (fino a 16) Art. SA600 91,80€



Art. SUNI 18,40€

8,4x8,4x2,8 cm

Scatola a parete per ricevitore a incasso.

COMPATIBILE

con: alexa

GOOGLE Assistance

App: SALUS Premium Lite



Termostato ELY DESIGN ADVANCE con base di ricarica e piastra di fissaggio: comunica solo con apparecchi elettrici fino a 16 unità

# ESECUZIONI SPECIALI - MENSOLE

PREZZI DAL 01.03.2026 +5%

## CALORIFERI AD ANGOLO

A richiesta, i caloriferi EGON, FORM e GRATA, sono costruiti su misura in forme ad angolo per risolvere in modo funzionale il riscaldamento di quegli ambienti dove la conformazione di pareti e aperture ostacola il tradizionale posizionamento del calorifero.

Le soluzioni più utilizzate sono:

- ad angolo interno
- ad angolo esterno
- con due angoli esterni

Inoltre disegno quotato per fattibilità e preventivo.

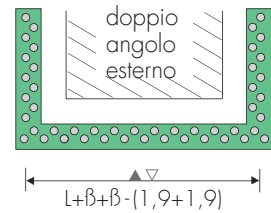
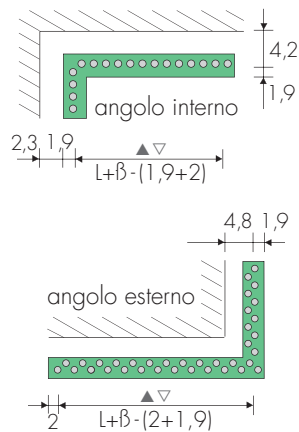

Larghezze per caloriferi d'angolo

dimensione (β) mm + calorifero standard:

	Mod.	F2H	GRH	EH
angolo interno	β	25	30	20
angolo esterno	β	20	30	25

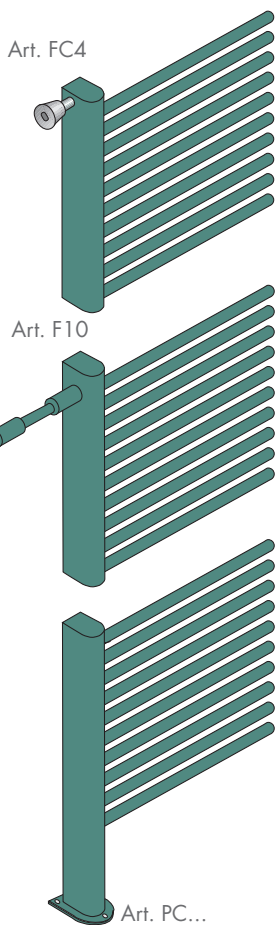

## FORM - GRATA - CROSS - Scaldasalviette DIVISORI

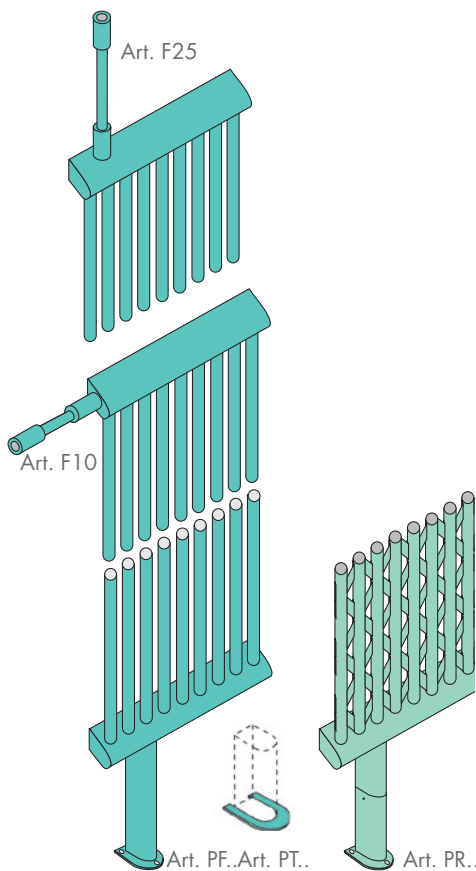

Mod. CROSS  
Piedino regolabile  
H 12-15 cm

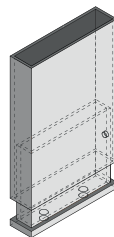

Art. PCV12  
111,30€

Piedini e supporti speciali consentono di collocare alcuni caloriferi o scaldasalviette come divisorio, per ricercare negli interni piacevoli e funzionali soluzioni architettoniche.

### FISSAGGI

Fissaggio verniciato laterale  
cm 10 riducibile a 4 Art. F10 74,90€

Fissaggio verniciato a soffitto  
cm 25 riducibile a 4 Art. F25 78,10€

Fissaggio cromato laterale con manicotto  
regolazione 4/6 cm Art. FC4 64,10€

Il fissaggio FC4 si avvita nel manicotto M18  
supplementare Art. M18 21,50€

A richiesta fissaggi con lunghezze su misura.

### PIEDINI

Piedino collettore  
h = 15 cm Art. PC15 89,40€  
h = 19 cm Art. PC19 89,40€

Piedino fisso  
h di serie cm 15 Art. PF15 78,50€

Piedino regolabile  
h di serie cm 15/20 Art. PR15 94,30€

Copri-piedino  
(copre le viti di fissaggio) Art. PT... 32,70€

A richiesta piedini con lunghezze su misura.

## MENSOLE

Le mensole in resina termoplastica o in metallo consentono la regolazione in profondità e sono sempre comprese nell'imballo.

Per la posa dei radiatori applicare al muro le mensole in dotazione.  
Il fondello della mensola ha il foro ovale per la regolazione sul muro.

- Art. B15..(mm)
- Art. B27..(mm)
- Art. B35..(mm)
- Art. B55..(mm)
- Art. B70..(mm)

Mensola:  
(B) bianca 14,50€  
(V) colorata 18,20€



Mensola	Bianca (B)	Colorata (V)
Mod. EOS..	9,00€	12,30€
Mod. META		
Art. 105..	14,50€	18,20€
Art. 109..	14,50€	18,20€
Art. 111..	14,50€	18,20€

Mod. WIND		
Art. 131.. (w3-w4)	8,10€	11,90€
Art. 151.. (w5-w6)	8,10€	11,90€

Art. MH4..	14,50€	18,20€
Art. MH14..	24,50€	30,60€



Mensola bianca (prof. 8 cm): Art. M8B 15,20€  
Art. M8KB 15,20€

Mensola cromata (prof. 8 cm): Art. M8C 23,40€  
Art. M8KC 23,40€

Mensola bianca (prof. 4 cm): Art. M4B 12,20€  
Art. M4GB 12,80€

Art. M4KB 16,10€  
Art. M4FB 16,10€

Mensola cromata Art. M4C 21,20€  
Art. M4GC 21,20€

Art. M4KC 21,20€  
Art. M4FC 25,80€



## PORTA-SALVIETTE RAM

Porta-salviette in metallo verniciato applicabile con magneti su tutte le piastre in acciaio, (35x44x7 cm), portata magneti 3,5 kg

Art. RAM 155,30€

RAM colori di serie: - grigio sablé SB7039  
- bianco sablé SB9016 - nero sablé SB9005

Nel colore del radiatore ordinato insieme +15/25%  
In un colore della tabella Brem diverso dallo scaldasalviette Supplemento Art. CM 49,00€



## POMOLO APPENDIABILI CROMO

(ø 6 x 4 cm) cad. Art. PA 69,40€

Finitura cromo per tutti gli scaldasalviette con tubi tondi escluso PLUS 18



## POMOLINI CROMO

(ø 3 x 3,5 cm) Art. AC n°2 81,20€

Finitura cromo per tutti gli scaldasalviette con tubi tondi escluso PLUS 18



## PORTA-SALVIETTE MAGNET

Porta-salviette magnetico in metallo verniciato applicabile su tutte le piastre in acciaio.

(40x3,3x6,2 cm) Art. MAG40 129,00€

(50x3,3x6,2 cm) Art. MAG50 133,00€

MAGNET colori di serie: - grigio sablé SB7039  
- bianco sablé SB9016 - nero sablé SB9005

Nel colore del radiatore ordinato insieme +15/25%  
In altri colori Brem Supplemento Art. CM 49,50€

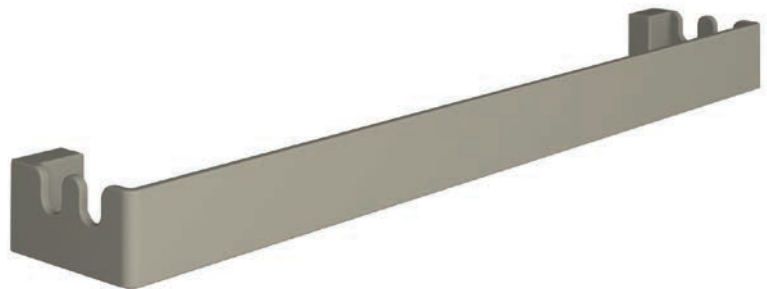

## APPENDINI Magnetici

Appendini in metallo verniciati nei colori Brem e base nickel-cromo con magnete applicabile su piastre e tubi piatti in acciaio, portata 4 kg.

APPENDINI colori di serie: - grigio sablé SB7039  
- bianco sablé SB9016 - nero sablé SB9005  
- nello stesso colore del radiatore ordinato.

## APPENDINI a parete

design Luigi Brembilla

A richiesta APPENDINI con fissaggio murale  
Supplemento 5,00€



Art. ARO..  
14x4,5x4



Art. PO..  
8,5x7x4



Art. HK..  
14x9x5

MODELLO ARO Art. ARC 87,40€  
Verniciatura fino a 3 pezzi per colore della tabella Brem Supplem. 49,50€ - da 4 pz. +15/25%

MODELLO PO Art. POC 87,40€  
Verniciatura fino a 3 pezzi per colore della tabella Brem Supplem. 49,50€ - da 4 pz. +15/25%

MODELLO HK Art. HKC 87,40€  
Verniciatura fino a 3 pezzi per colore della tabella Brem Supplem. 49,50€ - da 4 pz. +15/25%

# ATTACCHI CALORIFERI - SCALDASALVIETTE

PREZZI DAL 01.03.2026 **+5%**

Gli attacchi per collegare caloriferi e scaldasalviette all'impianto di riscaldamento sono ottenuti realizzando sui collettori due manicotti  $\varnothing 1/2"$  o  $\varnothing 3/8"$  secondo i modelli.

Nei disegni tecnici di ogni modello, oltre alla distanza minima dalla parete al calorifero, vi sono le indicazioni per ricavare la misura dell'interasse attacchi.

Posizione attacchi

- ▲ - mandata
- ▼ - ritorno
- S - sfogo d'aria
- V - scarico

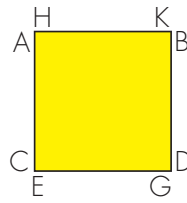

## ATTACCHI BITUBO

L'allacciamento è codificato con lettere che identificano le posizioni dei raccordi:

- la prima indica la mandata

- la seconda il ritorno

segue il diametro dell'attacco: es. AC  $\varnothing 1/2"$

## ATTACCHI BITUBO

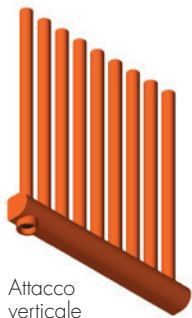

Attacco verticale

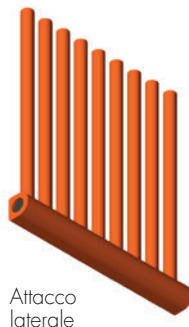

Attacco laterale

## ATTACCHI BITUBO REVERSI



Attacco reverso



Attacco verticale



Attacco laterale

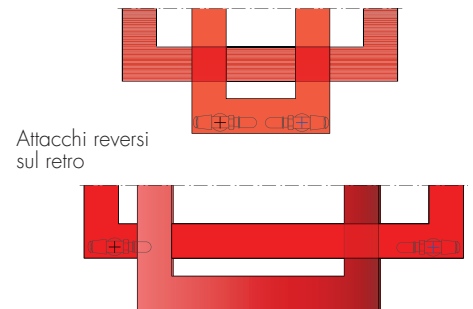

Attacchi reversi sul retro

## ATTACCO DI SERIE $\varnothing 1/2"$ - $3/8"$

Il radiatore è costruito con l'attacco di serie indicato nei dati tecnici di ogni modello.

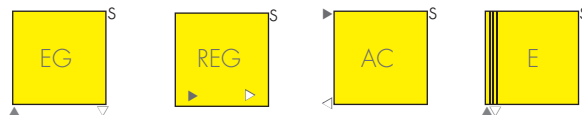

ATTACCHI A RICHIESTA senza supplemento se non indicato diversamente nella pagina tecnica di ogni modello

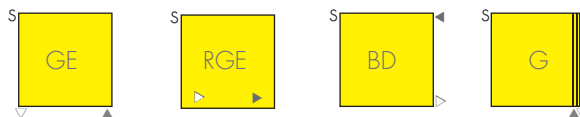

## ATTACCHI SPECIALI

Attacchi su misura, laterali, reversi, verticali. Richiedere fattibilità

Art. AS 81,40€

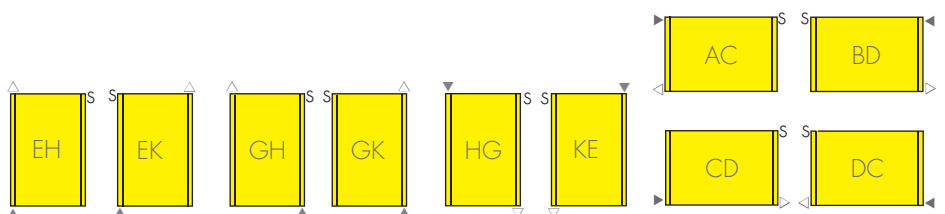

### ATTACCHI per Valvole BITUBO

Attacchi con interasse 5 cm eseguiti con separatore interno nel collettore Art. AS 81,40€

Attacchi speciali particolari con interasse 5 cm o su misura con separatori o eventuali sonde interne nel collettore, (richiedere fattibilità)  
Art. ASP 118,90€

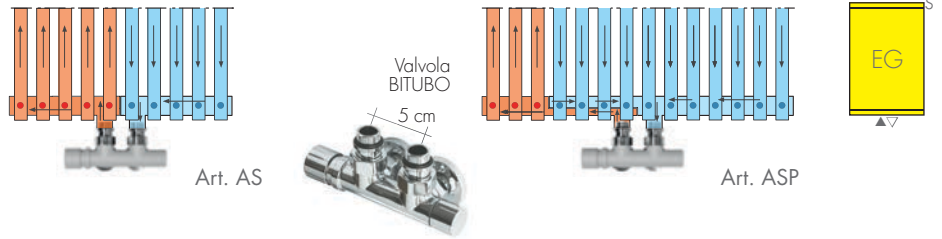

### ATTACCHI MONOTUBO con SONDA

L'allacciamento monotubo, eseguito solo in asse al collettore, è costruito applicando un raccordo  $\varnothing 1/2"$  da cui l'acqua entra ed esce. L'acqua calda dell'impianto entra in una sonda  $\varnothing 10\text{mm}$  fino oltre un separatore forato inserito all'interno del collettore dove inizia la circolazione del radiatore.

Attacco monotubo di serie:  $\varnothing 1/2"$  sonda  $\varnothing 10\text{ mm}$ ) Art. AM10 53,40€

La valvola monotubo (pag. 273) è completa di sonda o canna lunga 45 cm; a richiesta:  
sonda L= 70 cm Art. S70 12,60€  
sonda L=100 cm Art. S100 16,80€  
All'ordine indicare il diametro dell'attacco e della sonda se diversi da quelli di serie.

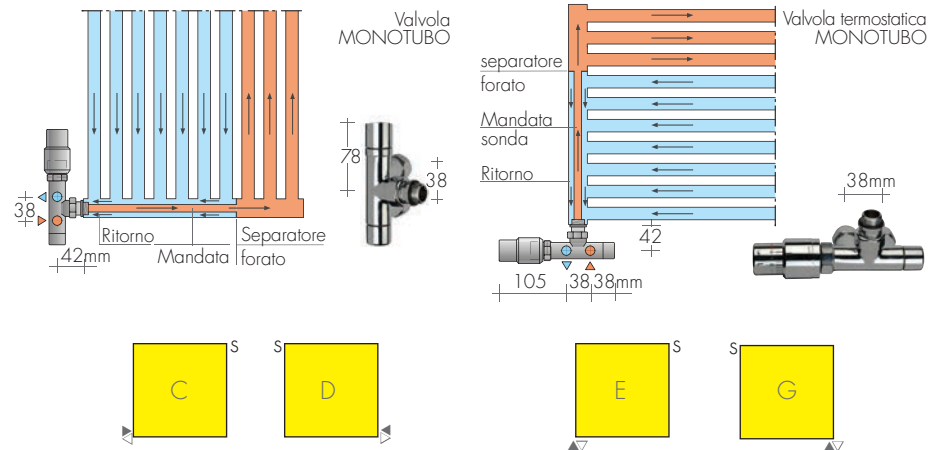

La valvola cromata monotubo Brem  $\varnothing 1/2"$ , con sonda  $\varnothing 10\text{ mm}$ , può essere usata nella versione termostatica o manuale ed è dotata di deviatore di flusso per invertire mandata e ritorno.

RICHIEDERE FATTIBILITÀ e POSIZIONE ATTACCHI

### TAPPI E SFIATI

- Art. T18 Tappo cromato  $\varnothing 1/8"$  3,50€
- Art. T14 Tappo cromato  $\varnothing 1/4"$  3,50€
- Art. T38 Tappo cromato  $\varnothing 3/8"$  3,50€
- Art. T12 Tappo cromato  $\varnothing 1/2"$  3,50€
- Art. S18 Sfiato cromato  $\varnothing 1/8"$  3,50€
- Art. S12 Sfiato cromato  $\varnothing 1/2"$  3,50€

### SCALDASALVIETTE CON CORNICE

Cornice scaldasalviette con manicotti per interasse attacchi su misura, manicotto per resistenza e tappo cromo

Art. CS 117,10€



### ATTACCHI SPECIALI PARTICOLARI

Attacchi su misura realizzati con sonde all'interno dei collettori o particolari separatori per ottenere l'ottimale circolazione dell'acqua calda.

Richiedere fattibilità

Art. ASP 118,90€

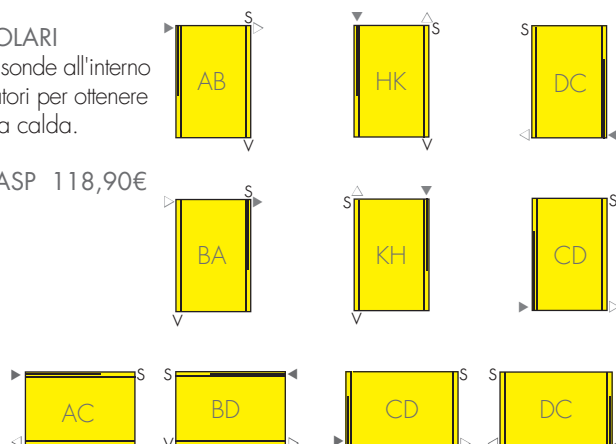

### ATTACCHI per VALVOLE REMOTE

Brem propone attacchi costituiti da manicotti filettati ( $\varnothing 24\text{ F19}$ ) saldati sul retro del calorifero (pag. 274). Art. REM 37,60€





# INDEX BREM'ART

RADIATORI DI ARTISTI

## L'ARTE E IL CALORIFERO

Brem, sempre alla ricerca di forme ed espressioni nuove, sorprendenti ma anche pratiche nel vestire il calore, ha chiesto all'Arte risposte sul tema, interpretazioni ed interventi, invenzioni e soluzioni.

È nata "Brem'Art" dove Brem propone una serie di caloriferi disegnati da Artisti ai quali è stata data piena libertà di esprimere la propria creatività nell'ambito di una logica legata alla funzione calore.

OGNI OPERA È FATTA  
A MANO:  
LE MINIME IMPERFEZIONI,  
LE SFUMATURE DIVERSE,  
I TONI E LE GRADAZIONI  
DI COLORE, MAI UGUALI  
DA PEZZO A PEZZO,  
NOBILITANO IL RISULTATO  
RENDENDO L'OPERA  
DAVVERO UNICA.

### COLORAZIONI & FINITURE SPECIALI BREM

- BR 0001, Finitura lucida trasparente su ferro naturale che lascia in evidenza le tracce di lavorazione (saldature, rigature, spazzolature, aloni, macchie ecc.); Il processo di fosfosgrassaggio esalta il colore dell'acciaio nelle tonalità di grigio, beige, blu, marrone, verdone e rende ogni pezzo diverso da un altro. Questa finitura è espressione di "Arte povera"

- BR 0001 MS, Finitura trasparente opaca, trasmette tutta la "brutalità" della materia prima; la finitura lucida, ne ingentilisce l'aspetto.

- BR 0031 Metallo spazzolato con finitura trasparente brillante per una superficie originale.  
- BR 0031ST Metallo spazzolato con finitura trasparente opaca

- BR 0007 è la tinta metallizzata più vicina al colore del ferro e copre eventuali imperfezioni.

- BR 0021 finitura trasparente lucida, trasmette l'effetto dell'ottone intravedendo le saldature.  
- BR 0021ST finitura trasparente opaca

- BR0022BL finitura lucida color ruggine sfumato  
- SB 0022 finitura sablé color ruggine sfumato

Per ogni opera sono indicati colori e finiture.

SPAZIO CHIUSO	III
FILU&FERRU	IV
BACCU MANDARA	V
CAPITONNÉ	VI
MUN	VII
CONTINUUM SIPAR	VIII
ERUZIONE	IX
STROP'	X
CIRCO D'IDEE	XI
SCUDO DI ERACLE	XII
NOSTOS	XIII
FIRE	XIV
PINAK HOT	XV
EAGLE	XVI
GRID	XVII
SHANG	XVIII
TERRA LUNARE	XIX
GRAFFI	XX
GRAFFI DI LUNA	XXI
PIET	XXII
VIRGO	XXIII



Le piastre Brem'Art sono costruite con uno spessore di solo 2,3cm e con la cover più alta della parte riscaldante per coprire le valvole.

Gli attacchi dietro la cover consentono alla testa termostatica, parzialmente in vista, di operare rilevando la temperatura ambiente.

La versione elettrica prodotta con altezze 180 e 200 cm e sporgenza di soli 5,8cm per la presenza dei dispositivi elettrici.

## DIMENSIONI VERSIONE IDRAULICA

Altezza 187-207-227 cm  
Larghezza 36-45-54-63-72 cm  
Profondità 4,8-5,0 cm  
Sporgenza dalla parete 7,8 cm

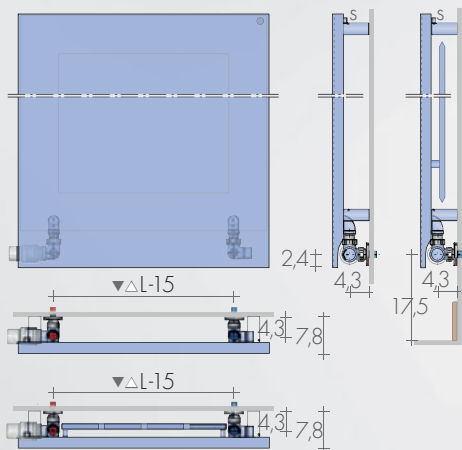
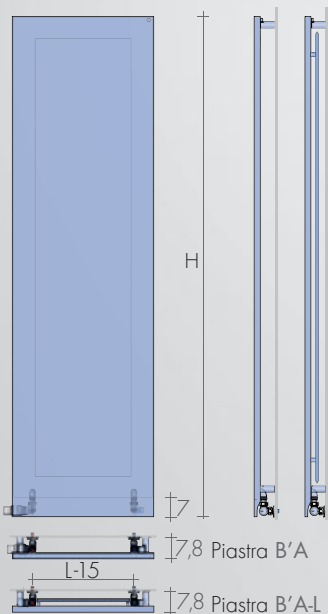

## DIMENSIONI VERSIONE ELETTRICA

Altezza 180-200 cm  
Larghezza 36-45-54 cm  
Profondità 2,3-4,3 cm  
Sporgenza dalla parete 5,8 cm

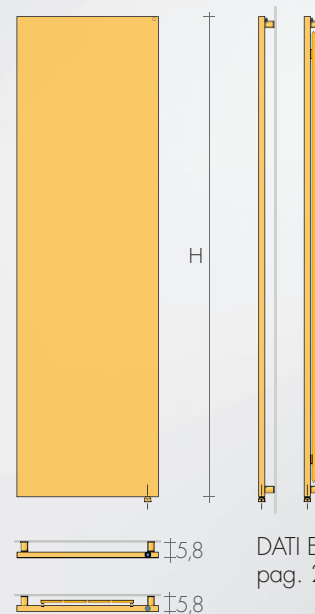

## ESECUZIONI DI SERIE

Tolleranze  $\pm 3$ mm - Valvola di sfiato  $\varnothing 1/8"$   
PRESSIONE MASSIMA D'ESERCIZIO 4 BAR

## ATTACCHI DI SERIE EG $\varnothing 1/2"$

B'A: Piastre Brem'Art  
Interasse Attacchi  $\blacktriangle \nabla$  L - 15 cm



## FISSAGGI

Mensole comprese  
Mod. Idraulici B55 (\*10)  
Mod. Elettrici B35 (\*3)

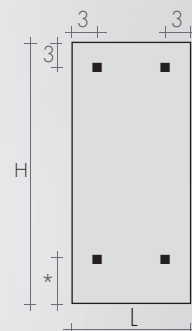

## VALVOLE CONSIGLIATE

Valvole TON e raccordi nichelati, volantino cromo



KIT VALVOLE nichelate TON comando LATERALE a semplice regolazione volantino cromo  
Art. KVLN 97,00€

KIT VALVOLE nichelate TON comando LATERALE, testa TERMOSTATICA,  
Art. KTLND 143,80€

KIT VALVOLE cromo TON comando LATERALE a semplice regolazione  
Art. KVL 139,20€

KIT VALVOLE cromo TON comando LATERALE, testa TERMOSTATICA, pag.269 Art. KTLD 188,60€

## KIT VALVOLE CROMO COMPRENDE:

- n°2 Valvole con codoli, Raccordi (multistrato  $\varnothing 16$  e rame  $\varnothing 12, 14$ ) e Rosette tonde  $\varnothing 48$ mm

Valvole CYL cromo con supplemento verniciatura



KIT VALVOLE cromo CYL termostattabile comando LATERALE, pag.273 Art. KCLD 150,50€

KIT VALVOLE cromo CYL testa TERMOSTATICA com. LATERALE, pag.273 Art. KCTLD 178,30€

VERNICIATURA KIT VALVOLE in una tinta della tabella colori Brem supplemento Art. VC 49,50€  
COLORI TESTE TERMOSTATICHE pag.266

## KIT RACCORDI in FINITURE SPECIALI pag.266

per Valvole colorate (codoli, raccordi rosette in finiture oro, bronzo,...)  
KIT Raccordi Nickel spazzolato supplemento Art. RN 28,20€



## A RICHIESTA

La piastra B'A ha altezze H-7cm e profondità 5,5 cm come i modelli elettrici con i seguenti attacchi  
- ATTACCHI EG  $\blacktriangle \nabla$  L - 4 cm con valvole a vista.  
- ATTACCHI REMOTI Art. REM 37,60€  
Interasse attacchi sul retro:  $\blacktriangle \nabla$  L - 6 cm  
Valvole REMOTE pag. 274

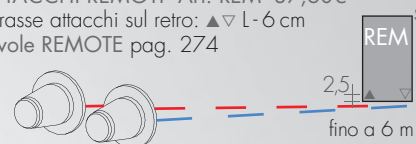

Rino Carrara propone un modello che esce dai rigidi schemi delle forme usuali, riprendendo e inserendo in un tratto avvolgente, i contenuti/forma che ama far vivere nelle sue opere.

**ESECUZIONI BREM'ART**

L'artista consiglia il colore bianco sablé SB 9016

Colori BREM a scelta, senza supplemento

**VALVOLE CONSIGLIATE**

KIT VALVOLE CROMATE comprende:

- n°1 Valvola Bitubo con codoli,
- n°2 Raccordi (multistr. ø 16 e rame ø12-14)
- n°2 Rosette cromo ø 48, foro ø16.



ATTACCHI DI SERIE EG ø 3/8" (o 1/2") ▲▽ 5 cm

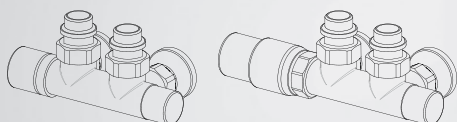

KIT valvola CYL BITUBO S TERMOSTATIZZABILE ▲▽ 5 cm, pag. 273 Art. KCB 158,80€

KIT valvola BITUBO S con testa TERMOSTATICA ▲▽ 5 cm, pag. 273 Art. KTB 186,60€

Colori KIT tabella BREM supplem. Art VC 49,50€

KIT Raccordi Nickel spazz. suppl. Art. RN 28,20€



KIT gruppo valvole REMOTE CYL page 274 TERMOSTATIZZABILE Art. KCG 207,70€

KIT gruppo valvole REMOTE CYL con Testa TERMOSTATICA Art. KCGT 223,40€

Colori KIT tabella BREM supplem. Art VC 49,50€

ATTACCHI REMOTI Art. REM 37,60€

Interasse attacchi sul retro: ▲▽ 5 cm



fino a 6 m



SPAZIO CHIUSO

Valvole TON REMOTE

**MODELLO'25**

	H-L cm	€	EN 442 Watt Δt 50 K	EN 442 Watt Δt 40K = Wx0,755	(Δt 30K = Wx0,526)	Altezza cm	Larghezza cm	Profondità cm
SPAZIO CHIUSO	145-95	2181,30	1300	5	145	95	3	

Tabella colori BREM pag.281

VERSIONI ELETTRICHE NON DISPONIBILI



Filu&Ferru.

Il nome proviene da un'antica tradizione sarda e riguarda un distillato di vinaccia. È una bevanda trasparente, forte e generosa che profonde calore per chi la gusta e accoglienza per chi la offre. E' il calore della famiglia e della casa nei mesi d'inverno. E' un gusto che rinfranca e rinvigorisce.

Ho pensato di dare questo nome a questo calorifero della collezione Brem per gli echi che risuonano nel nome (filo di ferro) e per i richiami al calore, all'ospitalità e alla intimità del focolare domestico.

#### ESECUZIONI BREM'ART

Opera in acciaio su fondo nero opaco cm 143x15x2; finitura della piastra nel colore grigio quarzo sablé SB 7039.

Colori BREM a scelta, senza supplemento.

#### VALVOLE CONSIGLIATE (pag.II)

KIT VALVOLE CROMATE comprende:  
n°2 Valvole con codoli, raccordi (multistrato ø16 e rame ø12-14) e rosette cromo ø48, foro ø16



ATTACCHI DI SERIE EG ø 1/2"  
Interasse Attacchi ▲▽ L - 15 cm  
Attacchi speciali pag.278



Valvole CYL REMOTE

EN 442 Watt Δt 50K (Δt 40K = Wx0,755) - (Δt 30K = Wx0,526)

MODELLO'25	H cm	L cm	EN 442 Watt Δt 50K (Δt 40K = Wx0,755) - (Δt 30K = Wx0,526)					
			36	45	54	63	72	
FILU	187	€	1835,70	1929,50	2027,10	2123,50	2216,90	
			713w	887w	1061w	1233w	1407w	
FILU-L	187	€	2130,90	2239,90	2373,70	2495,00	2615,70	
			909w	1181w	1453w	1723w	1996w	
FILU	207	€	1889,90	1991,40	2086,40	2186,80	2285,80	
			792w	985w	1178w	1369w	1562w	
FILU-L	207	€	2228,50	2358,20	2499,10	2620,10	2750,20	
			1011w	1313w	1616w	1916w	2219w	
FILU	227	€	1953,00	2058,80	2178,10	2273,60	2379,40	
			870w	1082w	1294w	1504w	1716w	
FILU-L	227	€	2284,30	2419,20	2565,90	2691,90	2826,70	
			1112w	1445w	1778w	2109w	2441w	

#### VERSIONI ELETTRICHE

MODELLO	H - L cm	Colori di serie €	KIT RE /KIT RT p.208	
			Cavo R..E/Faston R..T Art. (W) €	€
FILU	180-36	1835,70	R800II..	222,60
FILU	180-45	1929,50	R900II..	236,30
FILU	200-54	2086,40	R1200II..	255,90
FILU-L	180-45	2239,90	R1200II..	255,90
FILU-L	180-54	2373,70	R1500II..	276,00

ATTACCHI REMOTI: (H-7cm) ▲▽ L - 6 cm  
pag.II. Valvole REMOTE pag. 274



Interpretazione di Stefano Soddu:

BACCU MANDARA

Il mare è grigio, il cielo giallo.

Un pezzo di mare evapora in cielo  
e lo oscura con proiezione triangolare.

Come un aquilone, aspettando la pioggia.

## ESECUZIONI BREM'ART

L'artista consiglia i colori Sablé:

- ruggine sfumato SB 0022

- grigio quarzo SB 7039

Colori BREM a scelta, senza supplemento.

## VALVOLE CONSIGLIATE

(pag.11)

KIT VALVOLE CROMATE comprende:

n°2 Valvole con codoli, raccordi (multistrato ø16 e rame ø12-14) e rosette cromo ø48, foro ø16

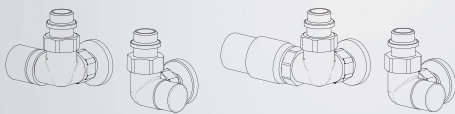

ATTACCHI DI SERIE EG ø1/2"

Interasse Attacchi ▲▼ L - 1,5 cm

Attacchi speciali pag.278



BACCU MANDARA 187-54

Valvola CYL con testa TERMOSTATICA

### VERSIONI ELETTRICHE

MODELLO	Colori di serie	KIT RE /KIT RT p.208
⚡ H - L cm	di serie €	Cavo R..E/Faston R..T Art. (W) €
BAC 180-36	1850,70	R800II.. 222,60
BAC 180-45	1954,50	R900II.. 236,30
BAC 200-54	2121,40	R1200II.. 255,90
BACL 180-45	2264,90	R1200II.. 255,90
BACL 180-54	2408,70	R1500II.. 276,00
Es: BAC180-45 SB 7039 1954,50€ + Kit elettrico R900II.. + Termostato pag. 208-209		

A RICHIESTA (in H-7cm - sporgenza 5,8cm) pag.11

- ATTACCHI EG ▲▼ L - 4 cm con valvole a vista.

- ATTACCHI REMOTI ▲▼ L - 6 cm; Valvole p.274

MODELLO	H cm	L cm ▲▼	EN 442 Watt Δt 50K (Δt 40K = Wx0,755) - (Δt 30K = Wx0,526)					
			36	45	54	63	72	
BAC 187 €	1850,70	21	713w	887w	1061w	1233w	1407w	
BACL 187 €	2145,90	30	909w	1181w	1453w	1723w	1996w	
BAC 207 €	1904,90	45	792w	985w	1178w	1369w	1562w	
BACL 207 €	2243,50	54	1011w	1313w	1616w	1916w	2219w	
BAC 227 €	1968,00	63	870w	1082w	1294w	1504w	1716w	
BACL 227 €	2299,30	72	1112w	1445w	1778w	2109w	2441w	

Tabella colori BREM pag.281

Dati tecnici Piastre B'A pag.11

L'effetto della trapuntatura, disposta su rete di quadrati, viene trasferito sulla superficie metallica della piastra Brem'Art per evocare una moda rimasta nella storia dell'arredo.

#### ESECUZIONI BREM'ART

Colore consigliato SB 0022 Ruggine sablé sfumato, di serie

Verniciatura in un colore sablé a scelta senza supplemento.



CAPITONNÉ 187-54

Valvola CYL con testa TERMOSTATICA

#### VALVOLE CONSIGLIATE (pag.II)

KIT VALVOLE CROMATE comprende:  
n°2 Valvole con codoli, raccordi (multistrato ø16 e rame ø12-14) e rosette cromo ø48, foro ø16



ATTACCHI DI SERIE EG ø 1/2"  
Interasse Attacchi ▲▼ L - 15 cm  
Attacchi speciali pag.278



EN 442 Watt Δt 50K (Δt 40K = Wx0,755) - (Δt 30K = Wx0,526)

MODELLO	'25	L cm	EN 442 Watt Δt 50K (Δt 40K = Wx0,755) - (Δt 30K = Wx0,526)									
			H cm	▲▼cm	36	45	54	63	72			
CAPH	187	€	1775,70	1884,50	1997,10	2108,50	2216,90	713w	887w	1061w	1233w	1407w
CAPLH	187	€	2070,90	2194,90	2343,70	2480,00	2615,70	909w	1181w	1453w	1723w	1996w
CAPH	207	€	1829,90	1946,40	2056,40	2171,80	2285,80	792w	985w	1178w	1369w	1562w
CAPLH	207	€	2168,50	2313,20	2469,10	2605,10	2750,20	1011w	1313w	1616w	1916w	2219w
CAPH	227	€	1893,00	2013,80	2148,10	2258,60	2379,40	870w	1082w	1294w	1504w	1716w
CAPLH	227	€	2224,30	2374,20	2535,90	2676,90	2826,70	1112w	1445w	1778w	2109w	2441w

#### VERSIONI ELETTRICHE

MODELLO	H - L cm	Colori di serie €	KIT RE/KIT RT p.208 Cavo R..E/Faston R..T Art. (W) €
CAPH	180-36	1775,70	R800II.. 222,60
CAPH	180-45	1884,50	R900II.. 236,30
CAPH	200-54	2056,40	R1200II.. 255,90
CAPLH	180-45	2194,90	R1200II.. 255,90
CAPLH	180-54	2343,70	R1500II.. 276,00

Es: CAPH180-45 SB 0022 1884,50€ +  
Kit elettrico R900II.. + Termostato pag. 208-209

A RICHIESTA (in H-7cm - sporgenza 5,8cm) pag.II  
- ATTACCHI EG ▲▼ L - 4 cm con valvole a vista.  
- ATTACCHI REMOTI ▲▼ L - 6 cm; Valvole p.274

Una piastra radiante di colore bianco con la composizione artistica a tre colori che rievocano opere compositive realizzate negli anni '90.

#### ESECUZIONI BREM'ART

Composizione colorata 20 x 20 cm  
Piastra B'A colore bianco crema satinato  
Ral 9001-S.

Colori BREM solo sulla piastra B'A, senza supplemento.



MUN 187-45

Valvola CYL con testa TERMOSTATICA

#### VALVOLE CONSIGLIATE

(pag.11)

KIT VALVOLE CROMATE comprende:  
n°2 Valvole con codoli, raccordi (multistrato ø16 e rame ø12-14) e rosette cromo ø48 con foro ø16

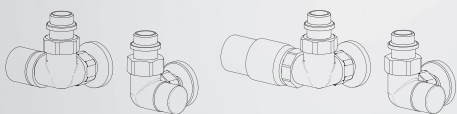

#### ATTACCHI DI SERIE EG ø 1/2"

Interasse Attacchi ▲▽ L - 15 cm  
Attacchi speciali pag.278



#### VERSIONI ELETTRICHE

MODELLO	Colori di serie	KIT RE/KIT RT p.208
H - L cm	€	Cavo R..E/Faston R..T Art. (W) €
MUN 180-36	1800,70	R800II.. 222,60
MUN 180-45	1894,50	R900II.. 236,30
MUN 200-54	2051,40	R1200II.. 255,90
MUNL180-45	2204,90	R1200II.. 255,90
MUNL180-54	2338,70	R1500II.. 276,00

Es: MUN 180-45 Ral 9001ST 1894,50€ +  
Kit elettrico R900II.. + Termostato pag. 208-209

A RICHIESTA (in H-7cm - sporgenza 5,8cm) pag.11  
- ATTACCHI EG ▲▽ L - 4 cm con valvole a vista.  
- ATTACCHI REMOTI ▲▽ L - 6 cm; Valvole p.274

MODELLO	H cm	L cm	EN 442 Watt Δt 50K (Δt 40K = Wx0,755) - (Δt 30K = Wx0,526)					
			36	45	54	63	72	
		▲▽cm	21	30	39	48	57	
MUN	187	€	1800,70 713w	1894,50 887w	1992,10 1061w	2088,50 1233w	2181,90 1407w	
MUNL	187	€	2095,90 909w	2204,90 1181w	2338,70 1453w	2460,00 1723w	2580,70 1996w	
MUN	207	€	1854,90 792w	1956,40 985w	2051,40 1178w	2151,80 1369w	2250,80 1562w	
MUNL	207	€	2193,50 1011w	2323,20 1313w	2464,10 1616w	2585,10 1916w	2715,20 2219w	
MUN	227	€	1918,00 870w	2023,80 1082w	2143,10 1294w	2238,60 1504w	2344,40 1716w	
MUNL	227	€	2249,30 1112w	2384,20 1445w	2530,90 1778w	2656,90 2109w	2791,70 2441w	

Tabella colori BREM pag.281

Dati tecnici Piastre B'A pag.11



CONTINUUM TRE 187-54

Valvola CYL TERMOSTATIZZABILE



SIPAR.W 187-54

Valvola CYL con testa TERMOSTATICA

Raffaele Cioffi ha interpretato il calore inserendo sul calorifero formelle dall'effetto tridimensionale.

Le opere "CONTINUUM" e "SIPAR.W", di grande intensità emotiva, costituiscono una alternanza di richiami cromatici tra zone d'ombra e zone di luce.

CONTINUUM TRE (H 45 x L 20 cm)

Stampa serigrafica.

L'artista propone la piastra nel colore BR 0007

SIPAR.W (H 100 x L 25 cm)

Stampa serigrafica.

L'artista propone la piastra nel colore SB 3061

Colori tabella Brem della piastra B'A senza supplemento.

## VALVOLE CONSIGLIATE (pag.II)

KIT VALVOLE CROMATE comprende:  
n°2 Valvole con codoli, raccordi (multistrato ø16 e rame ø12-14) e rosette cromo ø48, foro ø16



ATTACCHI DI SERIE EG ø 1/2"

Interasse Attacchi ▲▼ L - 15 cm

Attacchi speciali pag.278



MODELLO'25	H cm	L cm	EN 442 Watt Δt 50K (Δt 40K = Wx0,755) - (Δt 30K = Wx0,526)				
			36	45	54	63	72
		▲▼cm	21	30	39	48	57
A*..H	187	€	1720,70 713w	1814,50 887w	1912,10 1061w	2008,50 1233w	2101,90 1407w
A*..LH	187	€	2015,90 909w	2124,90 1181w	2258,70 1453w	2380,00 1723w	2500,70 1996w
A*..H	207	€	1774,90 792w	1876,40 985w	1971,40 1178w	2071,80 1369w	2170,80 1562w
A*..LH	207	€	2113,50 1011w	2243,20 1313w	2384,10 1616w	2505,10 1916w	2635,20 2219w
A*..H	227	€	1838,00 870w	1943,80 1082w	2063,10 1294w	2158,60 1504w	2264,40 1716w
A*..LH	227	€	2169,30 1112w	2304,20 1445w	2450,90 1778w	2576,90 2109w	2711,70 2441w

\*..: C continuum - S sipar.w  
Tabella colori BREM pag.281

Dati tecnici Piastre B'A pag.II

## VERSIONI ELETTRICHE

MODELLO'25	Colori di serie	KIT RE/KIT RT p.208
H - L cm	€	Cavo R..E/Faston R..T Art. (W) €
A*..H 180-36	1720,70	R800II.. 222,60
A*..H 180-45	1814,50	R900II.. 236,30
A*..H 200-54	1971,40	R1200II.. 255,90
A*..LH 180-45	2124,90	R1200II.. 255,90
A*..LH 180-54	2258,70	R1500II.. 276,00
Es: ACH180-45 continuum Ral9005-M 1814,50€		
Es: ASIH180-45 Sipar.w SB3061 2124,90€ +		
+ Kit elettrico R900II.. + Termostato pag. 208-209		
A RICHIESTA (in H-7cm - sporgenza 5,8cm) pag.II		
- ATTACCHI EG ▲▼ L - 4 cm con valvole a vista.		
- ATTACCHI REMOTI ▲▼ L - 6 cm; Valvole p.274		

Steven Cavagna in questa creazione ha scelto di far vivere la preziosità della foglia dorata sulla superficie ruggine dell'acciaio. Una immaginaria colata dorata che trasmette una forte emozione.

La colata dorata, realizzata a mano, è sempre diversa su ogni calorifero.

### ESECUZIONI BREM'ART (pag.I)

Finitura nel colore ruggine sfumato BR 0022BL brillante e foglia dorata.

Altri colori BREM a preventivo.



ERUZIONE 207-36

### VALVOLE CONSIGLIATE

(pag.II)

KIT VALVOLE CROMATE comprende:

n°2 Valvole con codoli, raccordi (multistrato ø16 e rame ø12-14) e rosette cromo ø48, foro ø16

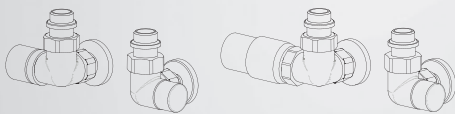

ATTACCHI DI SERIE EG ø 1/2"

Interasse Attacchi ▲▽ L - 15 cm

Attacchi speciali pag.278



Valvola CYL con testa TERMOSTATICA

### VERSIONI ELETTRICHE

MODELLO	H - L cm	Di serie BRO022BL €	KIT RE /KIT RT p.208	Art. (W) €
ERH 180-36	1830,70	1830,70	R800II..	222,60
ERH 180-45	1954,50	1954,50	R900II..	236,30
ERH 200-54	2131,40	2131,40	R1200II..	255,90
ERLH 180-45	2264,90	2264,90	R1200II..	255,90
ERLH 180-54	2418,70	2418,70	R1500II..	276,00

Es: ERH 180-45 BRO022BL 1954,50€  
+ Kit electric R900II.. + Termostato pag. 208-209

A RICHIESTA (in H-7cm - sporgenza 5,8cm) pag.II

- ATTACCHI EG ▲▽ L - 4 cm con valvole a vista.

- ATTACCHI REMOTI ▲▽ L - 6 cm; Valvole p.274

MODELLO '25	H cm	L cm	36	45	54	63	72
		▲▽cm	21	30	39	48	57
ERH 187	€	1830,70	1954,50	2072,10	2188,50	2311,90	
		713w	887w	1061w	1233w	1407w	
ERLH 187	€	2125,90	2264,90	2418,70	2560,00	2710,70	
		909w	1181w	1453w	1723w	1996w	
ERH 207	€	1884,90	2016,40	2131,40	2251,80	2380,80	
		792w	985w	1178w	1369w	1562w	
ERLH 207	€	2223,50	2383,20	2544,10	2685,10	2845,20	
		1011w	1313w	1616w	1916w	2219w	
ERH 227	€	1948,00	2083,80	2223,10	2338,60	2474,40	
		870w	1082w	1294w	1504w	1716w	
ERLH 227	€	2279,30	2444,20	2610,90	2756,90	2921,70	
		1112w	1445w	1778w	2109w	2441w	

Tabella colori BREM pag.281

Dati tecnici Piastre B'A pag.II



STROP 207-54

STROP 207-45

Valvola CYL con testa TERMOSTATICA

La luce gioca e rimbalza sulla superficie irregolare creando effetti inattesi e sempre variabili. L'idea di Steven Cavagna porta a un risultato artistico decisamente sorprendente. Il colore diventa parte integrante dell'opera.

L'esecuzione di ogni pezzo è rigorosamente manuale e mai identicamente ripetibile.

ESECUZIONI BREM'ART (pag. I)

Tinte tabella colori sablé Brem senza supplemento.

Altre tinte tabella colori Brem a preventivo.

VALVOLE CONSIGLIATE (pag.II)

KIT VALVOLE CROMATE comprende:  
n°2 Valvole con codoli, raccordi (multistrato ø16 e rame ø12-14) e rosette cromo ø48, foro ø16



ATTACCHI DI SERIE EG ø 1/2"  
Interasse Attacchi ▲▼ L - 15 cm  
Attacchi speciali pag.278



MODELLO	'25	H cm	L cm	EN 442 Watt Δt 50K (Δt 40K = Wx0,755) - (Δt 30K = Wx0,526)					
				36	45	54	63	72	72
SRH	187	€	1850,70	1954,50	2062,10	2168,50	2271,90		
			713w	887w	1061w	1233w	1407w		
SRLH	187	€	2145,90	2264,90	2408,70	2540,00	2670,70		
			909w	1181w	1453w	1723w	1996w		
SRH	207	€	1904,90	2016,40	2121,40	2231,80	2340,80		
			792w	985w	1178w	1369w	1562w		
SRLH	207	€	2243,50	2383,20	2534,10	2665,10	2805,20		
			1011w	1313w	1616w	1916w	2219w		
SRH	227	€	1968,00	2083,80	2213,10	2318,60	2434,40		
			870w	1082w	1294w	1504w	1716w		
SRLH	227	€	2299,30	2444,20	2600,90	2736,90	2881,70		
			1112w	1445w	1778w	2109w	2441w		

MODELLO	H - L cm	Colori di serie	KIT RE/KIT RT p.208	
			Cavo R..E/Faston R..T Art. (W)	€
SRH	180-36	1850,70	R800II..	222,60
SRH	180-45	1954,50	R900II..	236,30
SRH	200-54	2121,40	R1200II..	255,90
SRLH	180-45	2264,90	R1200II..	255,90
SRLH	180-54	2408,70	R1500II..	276,00
Es: SRH 180-45 Ral9005-M 1954,50€ + Kit electric R900II.. + Thermostat pag. 208-209				

Tabella colori BREM pag.281

Dati tecnici Piastre B'A pag.II

A RICHIESTA (in H-7cm - sporgenza 5,8cm) pag.II  
- ATTACCHI EG ▲▼ L - 4 cm con valvole a vista.  
- ATTACCHI REMOTI ▲▼ L - 6 cm; Valvole p.274

In questa opera Steven Cavagna ha giocato brutalmente con il materiale, forando manualmente con tecnica di taglio al Plasma una lastra di acciaio che, dopo l'intervento, risulta arricchita dagli effetti delle irregolarità dei fori e dei segni del fuoco sul metallo come elementi identitari significanti. Brem lo realizza su piastra B'A.

#### ESECUZIONI BREM'ART

Finitura in simil ottone sfumato e verniciato trasparente satinato BR 0021-S.

#### VALVOLE CONSIGLIATE

(pag.II)

KIT VALVOLE CROMATE comprende:  
n°2 Valvole con codoli, raccordi (multistrato ø16 e rame ø12-14) e rosette cromo ø48, foro ø16



ATTACCHI DI SERIE EG ø 1/2"  
Interasse Attacchi ▲▼ L - 15 cm  
Attacchi speciali pag.278



CIRCO D'IDEE 187-45

Valvola CYL TERMOSTATIZZABILE

VERSIONI ELETTRICHE				EN 442 Watt Δt 50K (Δt 40K = Wx0,755) - (Δt 30K = Wx0,526)					
MODELLO '25	COLORI di serie	KIT RE /KIT RT p.208	MODELLO '25	L cm	36	45	54	63	
H - L	di serie	Cavo R..E/Faston R..T	H cm	▲▼cm	21	30	39	48	
cm	€	Art. (W) €	CRH	187	€	1900,70	2014,50	2132,10	2248,50
CRH 180-45	2014,50	R900II.. 236,30	CRLH	187	€	713w	887w	1061w	1233w
CRH 200-54	2191,40	R1200II.. 255,90	CRH	207	€	909w	1181w	1453w	1723w
CRLH 180-45	2324,90	R1200II.. 255,90	CRLH	207	€	792w	985w	1178w	1369w
CRLH 180-54	2478,70	R1500II.. 276,00	CRLH	207	€	2293,50	2443,20	2604,10	2745,10
Es:CRH 180-45	BRO021-S	2014,50€	CRH	227	€	1011w	1313w	1616w	1916w
+ Kit electric	R900II..	+ Thermostat pag. 208-209	CRH	227	€	2018,00	2143,80	2283,10	2398,60
			CRLH	227	€	870w	1082w	1294w	1504w
			CRLH	227	€	2349,30	2504,20	2670,90	2816,90
						1112w	1445w	1778w	2109w

A RICHIESTA (in H-7cm - sporgenza 5,8cm) pag.II  
- ATTACCHI EG ▲▼ L - 4 cm con valvole a vista.  
- ATTACCHI REMOTI ▲▼ L - 6 cm; Valvole p.274

Tabella colori BREM pag.281

Dati tecnici Piastre B'A pag.II



Lo Scudo di Eracle, realizzato in rame dall'artista, è dedicato al più grande eroe dell'antichità greca.

Antonio Pizzolante per BREM'ART trasforma in una calda struttura in rame il manufatto di Eracle che, oltre il tempo, si propone di conciliare, ancora una volta, forma e funzione.

SCUDO DI ERACLE (H 98 x L 28cm)

#### ESECUZIONI BREM'ART

L'artista propone la piastra nel colore sablé "ruggine sfumato" SB 0022.

Si segnala che la sfumatura di questo colore non è ripetibile; pertanto ogni volta presenta sfumature e toni che lo rendono unico.

Altre tinte della tabella colori Brem senza supplemento.

#### VALVOLE CONSIGLIATE (pag.II)

KIT VALVOLE CROMATE comprende:  
n°2 Valvole con codoli, raccordi (multistrato ø16 e rame ø12-14) e rosette cromo ø48, foro ø16



ATTACCHI DI SERIE EG ø 1/2"  
Interasse Attacchi ▲▼ L - 15 cm  
Attacchi speciali pag.278



SCUDO DI ERACLE 207-54  
Valvola CYL con testa TERMOSTATICA

EN 442 Watt Δt 50K (Δt 40K = Wx0,755) - (Δt 30K = Wx0,526)

MODELLO '25	H cm	L cm	EN 442 Watt Δt 50K (Δt 40K = Wx0,755) - (Δt 30K = Wx0,526)				
			36	45	54	63	72
SEH	187	€	2045,70 713w	2139,50 887w	2237,10 1061w	2333,50 1233w	2426,90 1407w
SELH	187	€	2340,90 909w	2449,90 1181w	2583,70 1453w	2705,00 1723w	2825,70 1996w
SEH	207	€	2099,90 792w	2201,40 985w	2296,40 1178w	2396,80 1369w	2495,80 1562w
SELH	207	€	2438,50 1011w	2568,20 1313w	2709,10 1616w	2830,10 1916w	2960,20 2219w
SEH	227	€	2163,00 870w	2268,80 1082w	2388,10 1294w	2483,60 1504w	2589,40 1716w
SELH	227	€	2494,30 1112w	2629,20 1445w	2775,90 1778w	2901,90 2109w	3036,70 2441w

#### VERSIONI ELETTRICHE

MODELLO '25	Colori di serie	KIT RE/KIT RT p.208
H - L cm	€	Cavo R..E/Faston R..T Art. (W) €
SEH 180-36	2045,70	R800II.. 222,60
SEH 180-45	2139,50	R900II.. 236,30
SEH 200-54	2296,40	R1200II.. 255,90
SELH 180-45	2449,90	R1200II.. 255,90
SELH 180-54	2583,70	R1500II.. 276,00
Es: SEH180-45 SB 0022 2139,50€ + + Kit elettrico R900II.. + Termostato pag. 208-209		

A RICHIESTA (in H-7cm - sporgenza 5,8cm) pag.II  
- ATTACCHI EG ▲▼ L - 4 cm con valvole a vista.  
- ATTACCHI REMOTI ▲▼ L - 6 cm; Valvole p.274

Punto caldo e accogliente, Nostos è pensato come un tramite multisensoriale fra gli oggetti della quotidianità e il vissuto più intimo degli abitanti, la metafora di un percorso personale nella relazione con lo spazio e la casa.

L'artista definisce infatti Nostos l'Archetipo del "ritorno a casa" di Ulisse, come racconto di un viaggio imprevedibile, capace di cambiare gli aspetti dell'esistenza.

### ESECUZIONI BREM'ART

L'opera Nostos è dipinta a mano dall'artista e con la riga colore Blu Oltremare Ral 5002 (di serie); a richiesta, la riga, nel colore Giallo Ocra Ral 1032, Rosso Pompei Ral 3011, Verde patina Ral 6000.

L'artista propone la piastra in colore grigio quarzo mica SB 7039.

Altre tinte sablé Brem senza supplemento.



### VALVOLE CONSIGLIATE

(pag.11)

KIT VALVOLE CROMATE comprende:

n°2 Valvole con codoli, raccordi (multistrato ø16 e rame ø12-14) e rosette cromo ø48, foro ø16

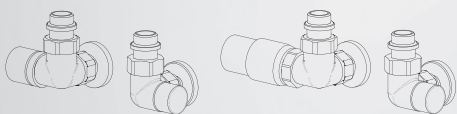

ATTACCHI DI SERIE EG ø 1/2"

Interasse Attacchi ▲▽ L - 15 cm

Attacchi speciali pag.278



NOSTOS 187-45

Valvola CYL TERMOSTATIZZABILE

### VERSIONI ELETTRICHE

MODELLO '25	H - L cm	Colori di serie €	KIT RE /KIT RT p.208	Cavo R..E/ Faston R..T Art. (W) €
N..	180-45	2009,50	R900II..	236,30
N..	200-54	2191,40	R1200II..	255,90
N..-L	180-45	2319,90	R1200II..	255,90
N..-L	180-54	2478,70	R1500II..	276,00

Es: NOSTOS180-45 SB 7039 2191,40€  
+ Kit elettrico R900II.. + Termostato pag. 208-209

A RICHIESTA (in H-7cm - sporgenza 5,8cm) pag.11  
- ATTACCHI EG ▲▽ L - 4 cm con valvole a vista.  
- ATTACCHI REMOTI ▲▽ L - 6 cm; Valvole p.274

MODELLO	'25	L cm	H cm	▲▽cm
NOSTOS	187	€	45 30	54 39
NOSTOS-L	187	€	887w 1061w	2132,10 2478,70
NOSTOS	207	€	1181w	1453w
NOSTOS-L	207	€	2071,40 985w	2191,40 1178w
NOSTOS-L	207	€	2438,20 1313w	2604,10 1616w
NOSTOS	227	€	2138,80 1082w	2283,10 1294w
NOSTOS-L	227	€	2499,20 1445w	2670,90 1778w

EN 442 Watt Δt 50K (Δt 40K = Wx0,755) - (Δt 30K = Wx0,526)

MODELLO	'25	L cm	H cm	▲▽cm
NOSTOS	187	€	45 30	54 39
NOSTOS-L	187	€	887w 1061w	2132,10 2478,70
NOSTOS	207	€	1181w	1453w
NOSTOS-L	207	€	2071,40 985w	2191,40 1178w
NOSTOS-L	207	€	2438,20 1313w	2604,10 1616w
NOSTOS	227	€	2138,80 1082w	2283,10 1294w
NOSTOS-L	227	€	2499,20 1445w	2670,90 1778w

Tabella colori BREM pag.281

Dati tecnici Piastre B'A pag.11



Segni di luce saettanti su specchio fumè, incisi a mano dall'artista Nicola Evangelisti, riverberano di luce un frammento di vetro di Murano rosso lava (30x30cm).

Luce, calore e riflessione uniscono arte e design in modo unico e speciale.

ESECUZIONI BREM'ART

Finitura calorifero Grigio Sablé SB 7039.

Altre tinte tabella colori Brem senza supplemento.

VALVOLE CONSIGLIATE (pag.II)

KIT VALVOLE CROMATE comprende:  
n°2 Valvole con codoli, raccordi (multistrato ø16 e rame ø12-14) e rosette cromo ø48, foro ø16

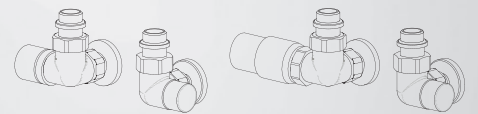

ATTACCHI DI SERIE EG ø 1/2"  
Interasse Attacchi ▲▼ L - 15 cm  
Attacchi speciali pag.278



FIRE 187-54

Valvola CYL con testa TERMOSTATICA

EN 442 Watt Δt 50K (Δt 40K = Wx0,755) - (Δt 30K = Wx0,526)

MODELLO'25	H cm	L cm	EN 442 Watt Δt 50K (Δt 40K = Wx0,755) - (Δt 30K = Wx0,526)			
			45	54	63	72
FIRE	187	▲▼cm	1844,50 887w	1942,10 1061w	2038,50 1233w	2131,90 1407w
FIRE-L	187	▲▼cm	2154,90 1181w	2288,70 1453w	2410,00 1723w	2530,70 1996w
FIRE	207	▲▼cm	1906,40 985w	2001,40 1178w	2101,80 1369w	2200,80 1562w
FIRE-L	207	▲▼cm	2273,20 1313w	2414,10 1616w	2535,10 1916w	2665,20 2219w
FIRE	227	▲▼cm	1973,80 1082w	2093,10 1294w	2188,60 1504w	2294,40 1716w
FIRE-L	227	▲▼cm	2334,20 1445w	2480,90 1778w	2606,90 2109w	2741,70 2441w

Tabella colori BREM pag.281

Dati tecnici Piastre B'A pag.II

VERSIONI ELETTRICHE

MODELLO	H - L cm	Colori di serie €	KIT RE/KIT RT p.208 Cavo R..E/Faston R..T Art. (W) €
FIRE	180-45	1844,50	R900II.. 236,60
FIRE	200-54	2001,40	R1200II.. 255,90
FIRE-L	180-45	2154,90	R1200II.. 255,90
FIRE-L	180-54	2288,70	R1500II.. 276,00

Es: FIRE180-45 SB 7039 1844,50€ + Kit elettrico R900II.. + Termostato pag. 208-209

A RICHIESTA (in H-7cm - sporgenza 5,8cm) pag.II  
- ATTACCHI EG ▲▼ L - 4 cm con valvole a vista.  
- ATTACCHI REMOTI ▲▼ L - 6 cm; Valvole p.274

Un grande cristallo specchiante è attraversato da un lampo di luce bianca (Lightsquare 30x30cm, Pinakhot-2 150x30cm, Luxury Lux 150x7cm).

Il nero cristallo è racchiuso nel radiatore che lo completa come una cornice.

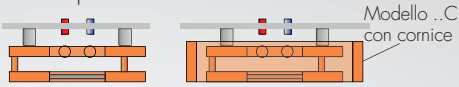

L'artista propone il calorifero nel colore nero SB 9005, altri colori Brem senza supplemento



## VALVOLE CONSIGLIATE

KIT VALVOLE CROMATE comprende: Valvole con codoli, raccordi (multistrato ø16 e rame ø12-14) e rosette cromo ø 48, foro ø16

KIT valvola CYL BITUBO TERMOSTATIZZABILE  
▲▽ 5 cm, pag. 273 Art. KCB 158,80€

KIT valvola CYL BITUBO con testa TERMOSTATICA  
▲▽ 5 cm, pag. 273 Art. KTB 186,60€

Colori tabella BREM suppl. Art.VC 49,50€

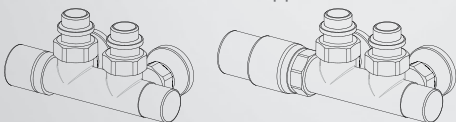

ATTACCHI DI SERIE  
EG ø3/8" ▲▽ 5 cm  
A richiesta ø1/2



KIT gruppo valvole REMOTE CYL page 274  
TERMOSTATIZZABILE Art. KCG 207,70€

KIT gruppo valvole REMOTE CYL con Testa  
TERMOSTATICA Art. KCGT 223,40€

KIT Raccordi Nickel spazz. suppl. Art. RN 28,20€

ATTACCHI REMOTI (▲▽ L-6 cm) pag.11  
Valvole REMOTE pag. 274

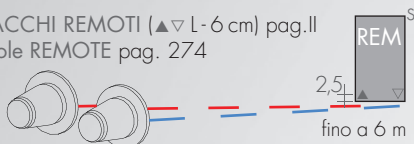

## MODELLO'25

	H - L cm	Colori di serie €	EN 442 Δt 50 K watt	▲▽ int.att. cm	profondità cm	KIT RE /KIT RT con Cavo R..E./Faston R..T Art. (W) €
LIGHTSQUARE	50-50	1202,90	289	5	9	R300II.. 179,40
LIGHTSQUARE-C	58-58	1526,30	523	5	9	R500II.. 193,10
PINAKHOT-2	172-50	2237,80	756	5	9	R800II.. 222,60
PINAKHOT-C	180-58	2561,20	1245	5	9	R1200II.. 255,90
LUXURY LUX	172-27	1248,30	654	5	9	R650II.. 206,40
LUXURY LUX-C	180-35	1584,60	1095	5	9	R1200II.. 255,90

Tabella colori BREM +15/+25% pag.281

Valvole TON REMOTE



Una piastra radiante, con l'aggiunta di lamine e tubi per ottenere un effetto plastico originale e dinamico, realizzata sul modello Clak.

### ESECUZIONI BREM'ART

Finitura in acciaio spazzolato BR 0031-ST verniciato trasparente opaco soft touch.

Colori sablé Brem senza supplemento.

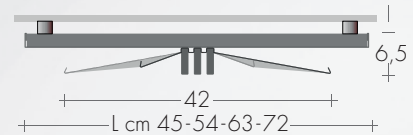

### VALVOLE CONSIGLIATE (pag.II)

KIT VALVOLE CROMATE comprende:  
n°2 Valvole con codoli, raccordi (multistrato ø16 e rame ø12-14) e rosette cromo ø48, foro ø16

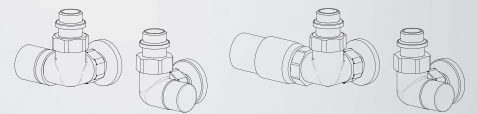

ATTACCHI DI SERIE EG ø 1/2"  
Interasse Attacchi ▲▼ L - 15 cm  
Attacchi speciali pag.278



EAGLE 187-54  
Valvola CYL con testa TERMOSTATICA

EN 442 Watt Δt 50K (Δt 40K = Wx0,755) - (Δt 30K = Wx0,526)

MODELLO'25	H cm	L cm	L cm			
			45	54	63	72
EAGLEH	187	€	1819,50 887w	1942,10 1061w	2063,50 1233w	2181,90 1407w
EAGLELH	187	€	2129,90 1181w	2288,70 1453w	2435,00 1723w	2580,70 1996w
EAGLEH	207	€	1881,40 985w	2001,40 1178w	2126,80 1369w	2250,80 1562w
EAGLELH	207	€	2248,20 1313w	2414,10 1616w	2560,10 1916w	2715,20 2219w
EAGLEH	227	€	1948,80 1082w	2093,10 1294w	2213,60 1504w	2344,40 1716w
EAGLELH	227	€	2309,20 1445w	2480,90 1778w	2631,90 2109w	2791,70 2441w

### VERSIONI ELETTRICHE

MODELLO	H - L cm	Colori di serie	KIT RE/KIT RT p.208
E..H	180-45	1819,50	R900II.. 236,30
E..H	200-54	2001,40	R1200II.. 255,90
E..LH	180-45	2129,90	R1200II.. 255,90
E..LH	180-54	2288,70	R1500II.. 276,00

Es: EAGLEH 180-45 BR 0031-ST 1819,50€  
+ Kit elettrico R900IIT + Termostato pag. 208-209

A RICHIESTA (in H-7cm - sporgenza 5,8cm) pag.II  
- ATTACCHI EG ▲▼ L - 4 cm con valvole a vista.  
- ATTACCHI REMOTI ▲▼ L - 6 cm; Valvole p.274

La trama di una griglia a maglia quadra traspare sotto la superficie trattata con rasatura di impasti a base di resine.

Ogni pezzo è realizzato a mano, quindi unico.

**ESECUZIONI BREM'ART**

Colori sablé di serie consigliati dall'artista,

Altri colori a preventivo.



**VALVOLE CONSIGLIATE**

(pag.II)

KIT VALVOLE CROMATE comprende:  
n°2 Valvole con codoli, raccordi (multistrato ø16 e rame ø12-14) e rosette cromo ø48, foro ø16

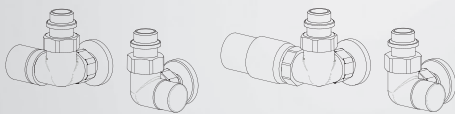

ATTACCHI DI SERIE EG ø 1/2"  
Interasse Attacchi ▲▼ L - 15 cm  
Attacchi speciali pag.278



GRID 187-45

Valvola CYL con testa TERMOSTATICA

VERSIONI ELETTRICHE				EN 442 Watt Δt 50K (Δt 40K = Wx0,755) - (Δt 30K = Wx0,526)							
MODELLO	Colori di serie	KIT RE/KIT RT p.208	MODELLO '25	L cm	36	45	54	63	72		
⚡	H - L	Cavo R..E/Faston R..T	H cm	▲▼cm	21	30	39	48	57		
cm	€	Art. (W) €	GRIDH	187	€	1790,70	1894,50	2002,10	2108,50	2211,90	
G..H 180-36	1790,70	R800II..	222,60			713w	887w	1061w	1233w	1407w	
G..H 180-45	1894,50	R900II..	236,30	GRIDLH	187	€	2085,90	2204,90	2348,70	2480,00	2610,70
G..H 200-54	2061,40	R1200II..	255,90			909w	1181w	1453w	1723w	1996w	
G..LH 180-45	2204,90	R1200II..	255,90	GRIDH	207	€	1844,90	1956,40	2061,40	2171,80	2280,80
G..LH 180-54	2348,70	R1500II..	276,00			792w	985w	1178w	1369w	1562w	
Es: GRID 180-45	1894,50€ +			GRIDLH	207	€	2183,50	2323,20	2474,10	2605,10	2745,20
Kit elettrico R900IIT + Termostato	pag. 208-209						1011w	1313w	1616w	1916w	2219w
				GRIDH	227	€	1908,00	2023,80	2153,10	2258,60	2374,40
							870w	1082w	1294w	1504w	1716w
				GRIDLH	227	€	2239,30	2384,20	2540,90	2676,90	2821,70
							1112w	1445w	1778w	2109w	2441w

A RICHIESTA (in H-7cm - sporgenza 5,8cm) pag.II  
- ATTACCHI EG ▲▼ L - 4 cm con valvole a vista.  
- ATTACCHI REMOTI ▲▼ L - 6 cm; Valvole p.274

Tabella colori BREM pag.281

Dati tecnici Piastre B'A pag.II



SHANG 187-54

Valvola CYL con testa TERMOSTATICA

Dalla piastra piana nasce un drappeggio che anima la superficie evocando sensazioni di vita intensa e profonda.

Il colore diventa protagonista di sfumature affascinanti nei cui solchi si adattano i ricordi.

### ESECUZIONI BREM'ART (pag.I)

Colori sablé di serie consigliati: Giallo  
Ginestra SB 1032 riferimento Ral 1032.

A richiesta Rosso Pompei SB 3011, Blu oltremare SB 5002, Verde patina SB 6000.  
Il numero colore corrisponde alla tabella RAL.

Altri colori sablé a preventivo.



### VALVOLE CONSIGLIATE (pag.II)

KIT VALVOLE CROMATE comprende:  
n°2 Valvole con codoli, raccordi (multistrato ø16 e rame ø12-14) e rosette cromo ø48, foro ø16



ATTACCHI DI SERIE EG ø 1/2"  
Interasse Attacchi ▲▼ L - 15 cm  
Attacchi speciali pag.278



MODELLO	H cm	L cm	EN 442 Watt Δt 50K (Δt 40K = Wx0,755) - (Δt 30K = Wx0,526)				
			36	45	54	63	72
SGH	187	€	1950,70	2054,50	2162,10	2268,50	2371,90
			713w	887w	1061w	1233w	1407w
SGLH	187	€	2245,90	2364,90	2508,70	2640,00	2770,70
			909w	1181w	1453w	1723w	1996w
SGH	207	€	2004,90	2116,40	2221,40	2331,80	2440,80
			792w	985w	1178w	1369w	1562w
SGLH	207	€	2343,50	2483,20	2634,10	2765,10	2905,20
			1011w	1313w	1616w	1916w	2219w
SGH	227	€	2068,00	2183,80	2313,10	2418,60	2534,40
			870w	1082w	1294w	1504w	1716w
SGLH	227	€	2399,30	2544,20	2700,90	2836,90	2981,70
			1112w	1445w	1778w	2109w	2441w

MODELLO	H - L cm	Colori di serie	VERSIONI ELETTRICHE	
			KIT RE/KIT RT p.208	Cavo R..E/Faston R..T Art. (W) €
SGH 180-36	1950,70	1950,70	R800II..	222,60
SGH 180-45	2054,50	2054,50	R900II..	236,30
SGH 200-54	2221,40	2221,40	R1200II..	255,90
SGLH 180-45	2364,90	2364,90	R1200II..	255,90
SGLH 180-54	2508,70	2508,70	R1500II..	276,00

Es: SGH180-45 SB3011 2054,50€ +  
+ Kit elettrico R900IIT + Termostato pag. 208-209

L'immaginario di una passeggiata sulla irregolare superficie della luna, la sensazione di spazio violato per la prima volta: ecco il messaggio da una forma scaldante che Steven Cavagna sa trasmettere con morbidezza.

## ESECUZIONI BREM'ART (pag.I)

Colori sablé di serie consigliati dall'artista,



A richiesta: Modello Terra Art. TRH  
Solo con trame orizzontali.  
Rese e prezzi come il modello Terra Lunare.

## VALVOLE CONSIGLIATE (pag.II)

KIT VALVOLE CROMATE comprende:  
n°2 Valvole con codoli, raccordi (multistrato ø16 e rame ø12-14) e rosette cromo ø48, foro ø16

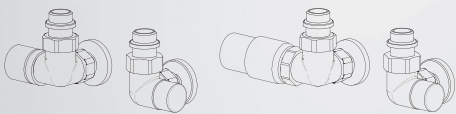

ATTACCHI DI SERIE EG ø 1/2"  
Interasse Attacchi ▲▼ L - 1,5 cm  
Attacchi speciali pag.278



TERRA LUNARE 207-45

Valvola CYL con testa TERMOSTATICA

### VERSIONI ELETTRICHE

MODELLO '25	H - L cm	Colori di serie €	KIT RE /KIT RT p.208 Cavo R..E/Faston R..T Art. (W) €
TEH	180-36	1930,70	R800II.. 222,60
TEH	180-45	2039,50	R900II.. 236,30
TEH	200-54	2211,40	R1200II.. 255,90
TELH	180-45	2349,90	R1200II.. 255,90
TELH	180-54	2498,70	R1500II.. 276,00

Es: TEH180-45 2039,50€ + Kit elettrico R900IIT + Termostato pag. 208-209

A RICHIESTA (in H-7cm - sporgenza 5,8cm) pag.II  
- ATTACCHI EG ▲▼ L - 4 cm con valvole a vista.  
- ATTACCHI REMOTI ▲▼ L - 6 cm; Valvole p.274

MODELLO '25	L cm	H cm	EN 442 Watt Δt 50K (Δt 40K = Wx0,755) - (Δt 30K = Wx0,526)				
			36	45	54	63	72
TEH	187	€	1930,70 713w	2039,50 887w	2152,10 1061w	2263,50 1233w	2371,90 1407w
TELH	187	€	2225,90 909w	2349,90 1181w	2498,70 1453w	2635,00 1723w	2770,70 1996w
TEH	207	€	1984,90 792w	2101,40 985w	2211,40 1178w	2326,80 1369w	2440,80 1562w
TELH	207	€	2323,50 1011w	2468,20 1313w	2624,10 1616w	2760,10 1916w	2905,20 2219w
TEH	227	€	2048,00 870w	2168,80 1082w	2303,10 1294w	2413,60 1504w	2534,40 1716w
TELH	227	€	2379,30 1112w	2529,20 1445w	2690,90 1778w	2831,90 2109w	2981,70 2441w

Tabella colori BREM pag.281

Dati tecnici Piastre B'A pag.II

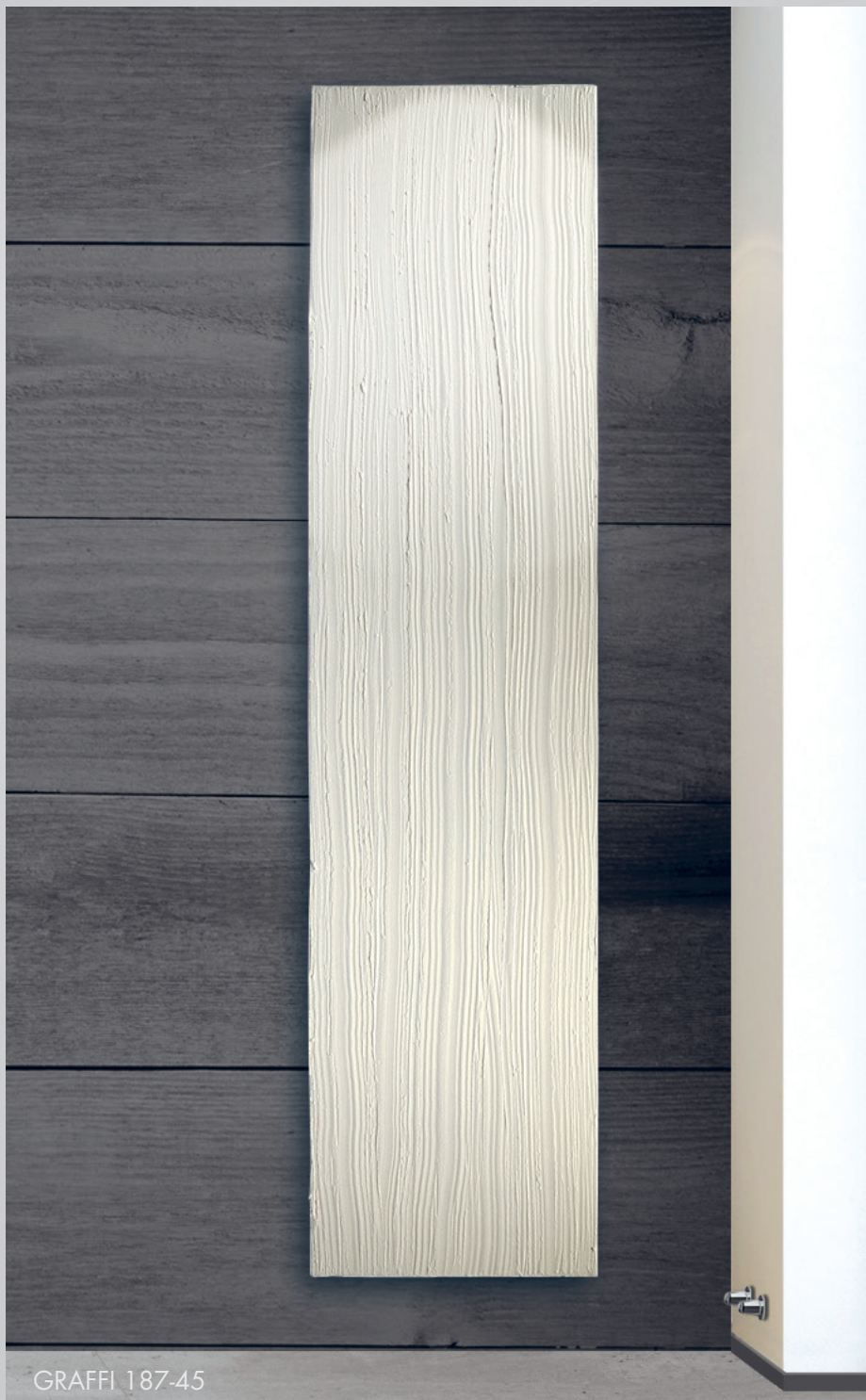

L'effetto estetico di GRAFFI è quello di una superficie completamente trattata da solchi appena accennati. Ne scaturisce un corpo scaldante che evoca atmosfere decisamente particolari e dove la luce ed il colore giocano un ruolo importante. Ogni pezzo è realizzato a mano e quindi unico.

ESECUZIONI BREM'ART (pag.II)  
Colori sablé tabella Brem, consigliati dall'artista.

Altri colori Ral nella sola finitura sablé a preventivo.

### VALVOLE CONSIGLIATE (pag.II)

KIT VALVOLE CROMATE comprende:  
n°2 Valvole con codoli, raccordi (multistrato ø16 e rame ø12-14) e rosette cromo ø48, foro ø16



ATTACCHI DI SERIE EG ø 1/2"  
Interasse Attacchi ▲▼ L - 15 cm  
Attacchi speciali pag.278



Valvole CYL REMOTE

EN 442 Watt Δt 50K (Δt 40K = Wx0,755) - (Δt 30K = Wx0,526)

MODELLO'25	H cm	L cm	EN 442 Watt Δt 50K (Δt 40K = Wx0,755) - (Δt 30K = Wx0,526)				
			▲▼ cm	36	45	54	63
GFH	187	€	1790,70	1894,50	2002,10	2108,50	2211,90
			713w	887w	1061w	1233w	1407w
GFLH	187	€	2085,90	2204,90	2348,70	2480,00	2610,70
			909w	1181w	1453w	1723w	1996w
GFH	207	€	1844,90	1956,40	2061,40	2171,80	2280,80
			792w	985w	1178w	1369w	1562w
GFLH	207	€	2183,50	2323,20	2474,10	2605,10	2745,20
			1011w	1313w	1616w	1916w	2219w
GFH	227	€	1908,00	2023,80	2153,10	2258,60	2374,40
			870w	1082w	1294w	1504w	1716w
GFLH	227	€	2239,30	2384,20	2540,90	2676,90	2821,70
			1112w	1445w	1778w	2109w	2441w

### VERSIONI ELETTRICHE

MODELLO	H - L cm	Colori di serie €	KIT RE/KIT RT p.208	
			Cavo R..E/Faston R..T Art. (W) €	€
GFH 180-36	1790,70	1790,70	R800II..	222,60
GFH 180-45	1894,50	1894,50	R900II..	236,30
GFH 200-54	2061,40	2061,40	R1200II..	255,90
GFLH 180-45	2204,90	2204,90	R1200II..	255,90
GFLH 180-54	2348,70	2348,70	R1500II..	276,00

ATTACCHI REMOTI (▲▼ L-6 cm) pag.II  
Valvole REMOTE pag. 274



Graffi accoglie la luna e diventa GRAFFI DI LUNA dove i solchi appena accennati lasciano spazio al liscio tondo crescente. Ogni pezzo è realizzato a mano, quindi unico.

## ESECUZIONI BREM'ART (pag.I)

Colori sablé tabella Brem, consigliati dall'artista.

Altri colori Ral nella sola finitura sablé a preventivo.

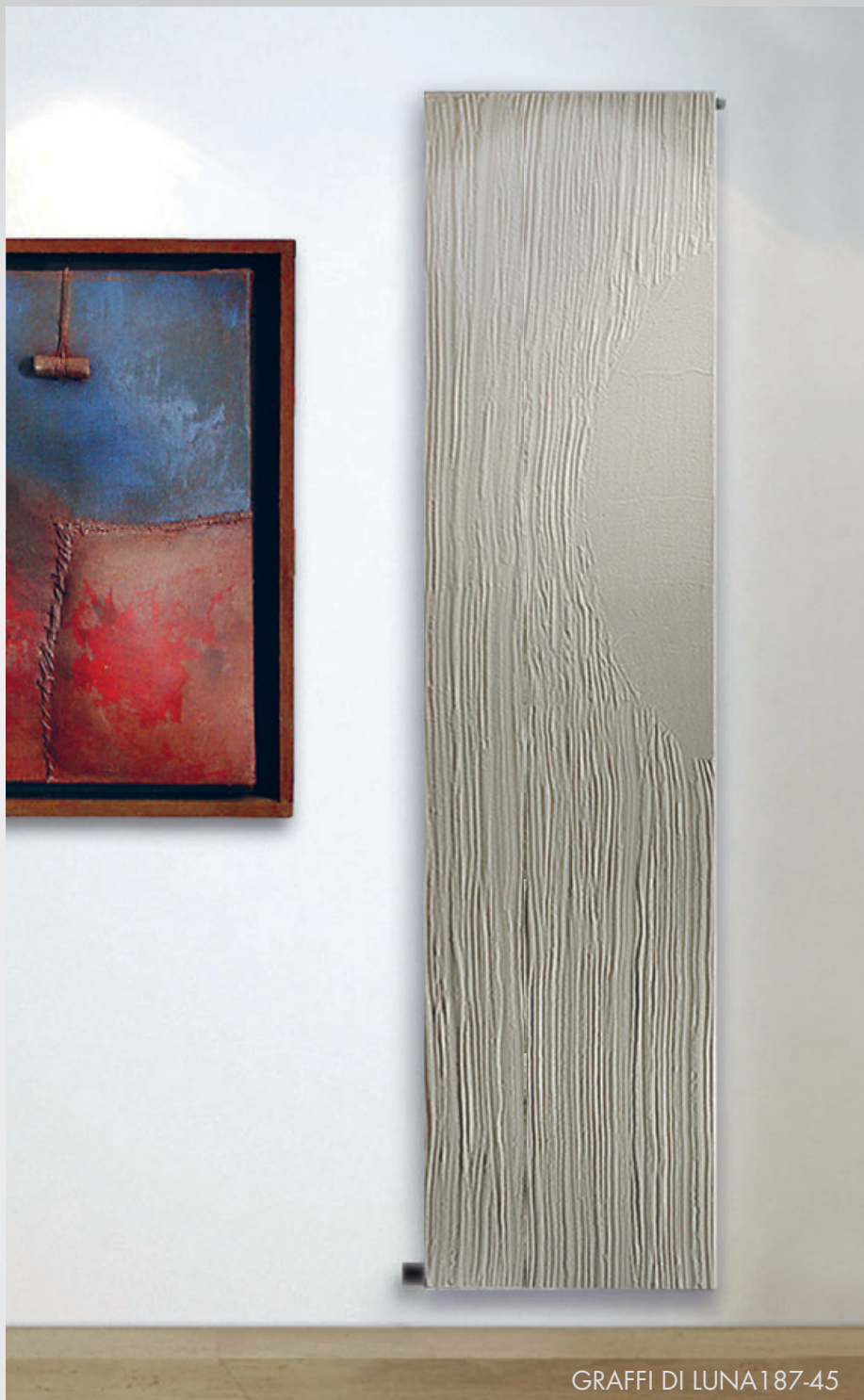

GRAFFI DI LUNA 187-45

Valvola CYL con testa TERMOSTATICA

## VALVOLE CONSIGLIATE (pag.II)

KIT VALVOLE CROMATE comprende:  
n°2 Valvole con codoli, raccordi (multistrato ø16 e rame ø12-14) e rosette cromo ø48, foro ø16

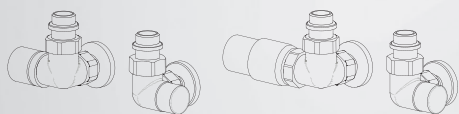

ATTACCHI DI SERIE EG ø 1/2"  
Interasse Attacchi ▲▼ L - 1,5 cm  
Attacchi speciali pag.278



### VERSIONI ELETTRICHE

MODELLO	Colori di serie	KIT RE/KIT RT p.208
H - L cm	€	Cavo R..E/Faston R..T Art. (W) €
GUH 180-36	1870,70	R800II.. 222,60
GUH 180-45	1979,50	R900II.. 236,30
GUH 200-54	2151,40	R1200II.. 255,90
GULH 180-45	2289,90	R1200II.. 255,90
GULH 180-54	2438,70	R1500II.. 276,00

Es: GUH180-45 1979,50€ + Kit elettrico R900IIT + Termostato pag. 208-209

EN 442 Watt Δt 50K (Δt 40K = Wx0,755) - (Δt 30K = Wx0,526)

MODELLO'25	L cm	36	45	54	63	72
H cm	▲▼cm	21	30	39	48	57
GUH 187 €		1870,70	1979,50	2092,10	2203,50	2311,90
		713w	887w	1061w	1233w	1407w
GULH 187 €		2165,90	2289,90	2438,70	2575,00	2710,70
		909w	1181w	1453w	1723w	1996w
GUH 207 €		1924,90	2041,40	2151,40	2266,80	2380,80
		792w	985w	1178w	1369w	1562w
GULH 207 €		2263,50	2408,20	2564,10	2700,10	2845,20
		1011w	1313w	1616w	1916w	2219w
GUH 227 €		1988,00	2108,80	2243,10	2353,60	2474,40
		870w	1082w	1294w	1504w	1716w
GULH 227 €		2319,30	2469,20	2630,90	2771,90	2921,70
		1112w	1445w	1778w	2109w	2441w

A RICHIESTA (in H-7cm - sporgenza 5,8cm) pag.II  
- ATTACCHI EG ▲▼ L - 4 cm con valvole a vista.  
- ATTACCHI REMOTI ▲▼ L - 6 cm; Valvole p.274

Tabella colori BREM pag.281

Dati tecnici Piastre B'A pag.II

Un omaggio a Piet Mondrian e alla sua lezione neoplasticista per questo termoarredo dove l'artista, intervenendo manualmente, ha dato vita su un fondo materico, linee verticali e orizzontali che si intersecano in un'opera dal rigore geometrico ed essenziale.

## ESECUZIONI BREM'ART

Finitura Bianco Sablé SB 9016,  
Parallelepipedi in rilievo colore grigio e rosso.

Altre tinte sablé Brem senza supplemento



PIET 187-45

Valvola CYL con testa TERMOSTATICA

## VALVOLE CONSIGLIATE (pag.11)

KIT VALVOLE CROMATE comprende:  
n°2 Valvole con codoli, raccordi (multistrato ø16 e rame ø12-14) e rosette cromo ø48, foro ø16

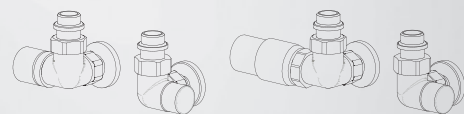

ATTACCHI DI SERIE EG ø 1/2"  
Interasse Attacchi ▲▽ L - 15 cm  
Attacchi speciali pag.278



EN 442 Watt Δt 50K (Δt 40K = Wx0,755) - (Δt 30K = Wx0,526)

MODELLO '25	H cm	L cm	EN 442 Watt Δt 50K (Δt 40K = Wx0,755) - (Δt 30K = Wx0,526)				
			36	45	54	63	72
PIET	187	€	1750,70 713w	1854,50 887w	1972,10 1061w	2078,50 1233w	2181,90 1407w
PIET-L	187	€	2045,90 909w	2164,90 1181w	2318,70 1453w	2450,00 1723w	2580,70 1996w
PIET	207	€	1804,90 792w	1916,40 985w	2031,40 1178w	2141,80 1369w	2250,80 1562w
PIET-L	207	€	2143,50 1011w	2283,20 1313w	2444,10 1616w	2575,10 1916w	2715,20 2219w
PIET	227	€	1868,00 870w	1983,80 1082w	2123,10 1294w	2228,60 1504w	2344,40 1716w
PIET-L	227	€	2199,30 1112w	2344,20 1445w	2510,90 1778w	2646,90 2109w	2791,70 2441w

## VERSIONI ELETTRICHE

MODELLO '25	Colori di serie	KIT RE /KIT RT p.208
H - L cm	€	Cavo R..E/Faston R..T Art. (W) €
PIET 180-36	1750,70	R800II.. 222,60
PIET 180-45	1854,50	R900II.. 236,30
PIET 200-54	2031,40	R1200II.. 255,90
PIET-L 180-45	2164,90	R1200II.. 255,90
PIET-L 180-54	2318,70	R1500II.. 276,00
Es: PIET 187-45 SB9016 1854,50€ + Kit elettrico R900II.. + Termostato pag. 208-209		

A RICHIESTA (in H-7cm - sporgenza 5,8cm) pag.11  
- ATTACCHI EG ▲▽ L - 4 cm con valvole a vista.  
- ATTACCHI REMOTI ▲▽ L - 6 cm; Valvole p.274

VIRGO, un calorifero la cui superficie è caratterizzata da solchi appena accennati che creano un decoro minimale ispirato alla natura. Delle fenditure si aprono come tagli nella superficie creando una discontinuità e rivelando l'anima interna del calorifero in acciaio.

Ogni pezzo è realizzato a mano e quindi unico con colori sablé di serie a scelta e colori satinati per i solchi.

ESECUZIONI BREM'ART

Finitura colori Sablé SB 9006,

Altre tinte sablé Brem senza supplemento



VALVOLE CONSIGLIATE

(pag.11)

KIT VALVOLE CROMATE comprende:

n°2 Valvole con codoli, raccordi (multistrato ø16 e rame ø12-14) e rosette cromo ø48, foro ø16



ATTACCHI DI SERIE EG ø 1/2"

Interasse Attacchi ▲▼ L - 15 cm

Attacchi speciali pag.278



VIRGO 2/187-45

VIRGO 3/187-54

Valvola CYL TERMOSTATIZZABILE

Valvola CYL con testa TERMOSTATICA

VERSIONI ELETTRICHE

MODELLO '25	H - L cm	Colori di serie	KIT RE /KIT RT p.208
		€	Cavo R..E/Faston R..T Art. (W) €
VR..H 180-36	187	1879,70	R800II.. 222,60
VR..H 180-45	187	1985,00	R900II.. 236,30
VR..H 200-54	207	2143,00	R1200II.. 255,90
VR..LH 180-45	207	2295,40	R1200II.. 255,90
VR..LH 180-54	207	2430,30	R1500II.. 276,00
Es: VR2H 180-45 Ral9005-M 1985,00€ + Kit elettrico R900II.. + Termostato pag. 208-209			

A RICHIESTA (in H-7cm - sporgenza 5,8cm) pag.11  
- ATTACCHI EG ▲▼ L - 4 cm con valvole a vista.  
- ATTACCHI REMOTI ▲▼ L - 6 cm; Valvole p.274

MODELLO '25	H cm	L cm	36	45	54	63	72
		▲▼cm	21	30	39	48	57
VR..H	187	€	1879,70	1985,00	2083,70	2191,40	2286,30
			713w	887w	1061w	1233w	1407w
VR..LH	187	€	2174,90	2295,40	2430,30	2562,90	2685,10
			909w	1181w	1453w	1723w	1996w
VR..H	207	€	1933,90	2046,90	2143,00	2254,70	2355,20
			792w	985w	1178w	1369w	1562w
VR..LH	207	€	2272,50	2413,70	2555,70	2688,00	2819,60
			1011w	1313w	1616w	1916w	2219w
VR..H	227	€	1997,00	2114,30	2234,70	2341,50	2448,80
			870w	1082w	1294w	1504w	1716w
VR..LH	227	€	2328,30	2474,70	2622,50	2759,80	2896,10
			1112w	1445w	1778w	2109w	2441w

Tabella colori BREM pag.281

Dati tecnici Piastre B'A pag.11

# TABELLA COLORI BREM

LA TONALITÀ DEI COLORI È INDICATIVA. CONSULTARE LA TABELLA SMALTI BREM PRESSO IL PUNTO VENDITA

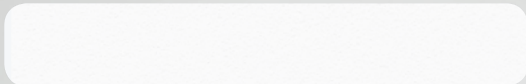

SB 9016 Bianco SABLÉ di serie, mod. C-PROLUX +25%

## COLORI DI SERIE

(vedi pagina tecnica di ogni modello)



Ral 9016 di serie solo mod. C-PROLUX, a richiesta altri modelli

### COLORI SEMI-LUCIDI

### COLORI SATINATI

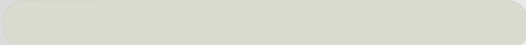

RAL 9002 Bianco grigiastro Satinato RAL 9002-S

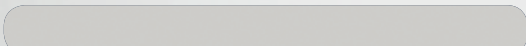

RAL 7047 Grigio Chinchilla Satinato RAL 7047-S



RAL 7044 Grigio seta Satinato RAL 7044-S



RAL 7030 Grigio pietra Satinato RAL 7030-S

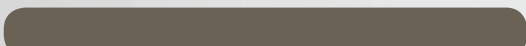

RAL 7006 Beige grigiastro Satinato RAL 7006-S



RAL 7036 Grigio platino Satinato RAL 7036-S



RAL 7037 Grigio polvere Satinato RAL 7037-S



RAL 7015 Grigio ardesia Satinato RAL 7015-S

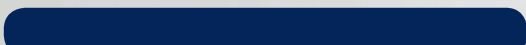

RAL 5013 Blu cobalto Satinato RAL 5013-S

Selezione di colori RAL che si possono richiedere nelle varie finiture da semi-lucide a opache, misurate in gloss:  
- Semi-lucida, 70-80 GU (gloss) ±5  
- Satinata, 50-60 GU  
- Opaca (Matt), 25-35 GU  
- SoftTouch, 5-10 GU

**COLORI SEMI-LUCIDI** AUMENTO +15%  
70-80 GU  
es. Ral 9002

**COLORI SATINATI** AUMENTO +15%  
50-60 GU  
es. Ral 9002-S

**COLORI SoftTOUCH** AUMENTO +25%  
5-10 GU  
es. Ral 9002-ST

Finitura dal tocco estremamente soffice e vellutato, facile da pulire, resistente alle impronte e all'abrasione (molto opaca) realizzabile su tutti i colori.

### COLORI SEMI-LUCIDI

### COLORI SATINATI

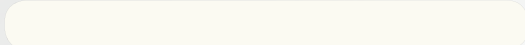

RAL 9010 Bianco puro

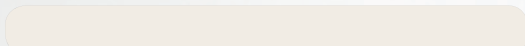

RAL 9001 Bianco crema Satinato RAL 9001-S



RAL 1013 Bianco perla Satinato RAL 1013-S



RAL 1015 Avorio chiaro Satinato RAL 1015-S



RAL 1017 Giallo zafferano Satinato RAL 1017-S



RAL 3000 Rosso fuoco Satinato RAL 3000-S



RAL 3003 Rosso rubino Satinato RAL 3003-S



RAL 3011 Rosso scuro "Pompei" Satinato RAL 3011-S



RAL 6000 Verde Patina Satinato RAL 6000-S

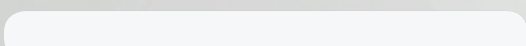

RAL 9016-M Bianco opaco (matt)



RAL 9010-M Bianco puro opaco (matt)

**COLORI OPACHI** AUMENTO +15%  
MATT 25-35 GU  
es. Ral 9005-M



RAL 8008-M Marrone Oliva opaco (matt)



RAL 9005-M Nero matt (Semi-lucido solo su alcuni modelli)



GA05 NICKEL SPAZZOLATO Satinato



GA09 CANNA DI FUCILE SPAZZOLATO satinato

**COLORI A EFFETTO GALVANICO** A PREVENTIVO  
Richiedere fattibilità

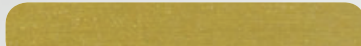

GA19 ORO SPAZZOLATO Satinato



GA23 RAME SPAZZOLATO Satinato



GA33 BRONZO SPAZZOLATO Satinato

## FINITURE SPECIALI +35%

- BR 0031 solo per piastre e tubi piatti finitura spazzolata per eliminare le imperfezioni e verniciata trasparente (BR 0007 è la tinta più simile al ferro).
- BR 0021 finitura trasparente gialla lucida, trasmette l'effetto dell'ottone lasciando trasparire le saldature.
- BR 0021-ST finitura trasparente soft-Touch
- BR 0022BL colore ruggine sfumato con finitura lucida (abbinato alla foglia oro nel mod. Eruzione)

### COLORI SEMI-LUCIDI 70 GU



BR 0031 Metallo spazzolato



BR 0021 Simil ottone



BR 0022BL Ruggine sfumato

FINITURE SPECIALI BREM (piastre escluse)  
- BR 0001, finitura lucida in metallo trasparente, sul ferro naturale lascia in evidenza tracce di lavorazioni (saldature, rigature, spazzolature, aloni, macchie...); il processo di fosfosgrassaggio esalta il colore dell'acciaio nelle tonalità di grigio, beige, blu, marrone, verdone e rende ogni pezzo diverso da un altro.  
- BR 0001 MS, finitura trasparente opaca, trasmette tutta la "brutalità" della materia prima; la finitura lucida, invece, ne ingentilisce l'aspetto. Queste finiture sono espressione di "Arte povera".

COLORI PER L'ARCHITETTURA: COLORI RAL NELLE VARIE FINITURE non inclusi nelle tabelle: +25%, + contributo spese secondo disponibilità e fattibilità

## COLORI METALLIZZATI +25%

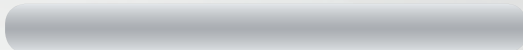

BR 0002 Alluminio semi-lucido



BR 0006 Alluminio metallizzato semi-lucido

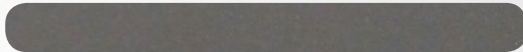

BR 0007 Grigio metallizzato semi-lucido



BR 0008 Nero metallizzato semi-lucido



BR 1035 Beige perlato semi-lucido



BR 0004 Alluminio dorato semi-lucido



BR 0019 Oro metallizzato semi-lucido



BR 0033 Bronzo metallizzato semi-lucido

## METALLIZZATI SATINATI +25%



BR 0019-MS Oro metallizzato satinato



BR 0033-MS Bronzo metallizzato satinato

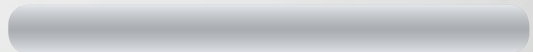

BR 0002-MS Alluminio satinato

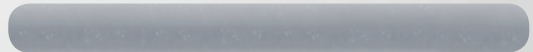

BR 0006-MS Alluminio metallizzato satinato



BR 0007-MS Grigio metallizzato satinato

## COLORI SABLÉ +25%

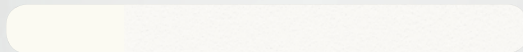

SB 9010 Bianco puro sablé

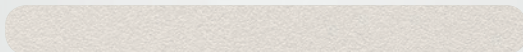

SB 7035 Grigio chiaro sablé

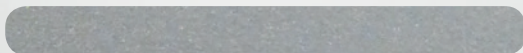

SB 9006 Alluminio sablé

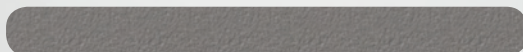

SB 9007 Alluminio grigiastro sablé

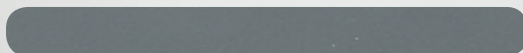

SB 7005 Grigio medio sablé



SB 7039 Grigio quarzo sablé



SB 7011 Grigio ferro sablé



SB 9005 Nero sablé



SB 5002 Blu oltremare sablé



SB 2639 Blu sablé

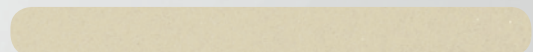

SB 1014 Avorio sablé

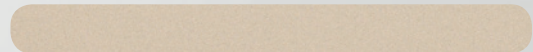

SB 370F Beige sablé



SB 356F Beige tortora sablé



SB 2589 Beige grigio sablé



SB 1032 Giallo ginestra sablé



SB 2008 Arancio sablé

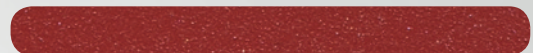

SB 3013 Rosso pomodoro sablé



SB 3003 Rosso rubino sablé



SB 0022 Ruggine sfumato sablé

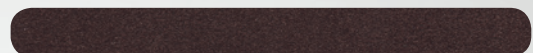

SB 3061 Rame scuro sablé

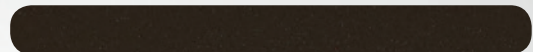

SB 3281 Grigio bruno sablé

# RISCALDARE, RISPARMIARE e ARREDARE

RISCALDARE E RISPARMIARE: LA GRANDE SFIDA DELLA CLIMATIZZAZIONE DEGLI EDIFICI - Dr. Ing. FRANCESCO PAOLETTI

## RISCALDARE e RISPARMIARE

Ricerca risparmio nei costi energetici del riscaldamento è l'impegno che tutti, progettisti, impiantisti, costruttori e legislatori, ricercano per:

- abbattere le emissioni inquinanti in atmosfera
- ottimizzare le prestazioni per il confort
- contenere il consumo energetico.

I due sistemi di riscaldamento più diffusi sono:

### - L'IMPIANTO A CALORIFERI

È il classico impianto di riscaldamento con caldaia o pompa di calore e caloriferi che, con una veloce trasmissione del calore (**bassa inerzia termica**), possono:

- funzionare sia a bassa che alta temperatura dell'acqua nell'impianto
- avere adeguamenti quasi istantanei alla variazione della temperatura con regolazioni semplici, economiche, di zona o per ambiente
- facilitare ed economizzare l'installazione
- minimizzare i consumi elettrici delle pompe

La bassa inerzia termica dei caloriferi rende facile mantenere l'ambiente alla temperatura di comfort (20°C) solamente quando serve e consente significativi risparmi energetici.

### - L'IMPIANTO RADIANTE A PAVIMENTO

solo ad alta inerzia termica, è realizzato con tubazioni in polietilene reticolato o multistrato posate su un pannello isolante, annegate nel massetto di sottofondo del pavimento ed è costituito da uno o più circuiti per ogni ambiente da riscaldare.

- La temperatura superficiale del pavimento non deve superare i 29 °C nelle zone di soggiorno e i 35 °C nelle zone servizi.
- La regolazione della temperatura ambiente può essere del tipo on/off con interruzione della circolazione dell'acqua, o modulante sulla temperatura di mandata dell'acqua.
- La regolazione per singolo ambiente è realizzata con valvole motorizzate su ogni circuito.
- Nei bagni va aggiunto uno scaldasalviette dal funzionamento elettrico o misto poichè i pannelli non assicurano il giusto confort.

Il calore viene prima trasmesso al massetto completo di pavimento e in seguito ceduto all'ambiente per riscaldare i locali, il tempo di messa a regime del pavimento radiante è di circa 6 o 4 ore a seconda della tipologia di sistema radiante (alta inerzia termica); il tempo necessario tra la richiesta/interruzione dell'emissione calore e la percezione nell'ambiente è notevole e determina un maggior consumo di energia.

## FABBISOGNO ENERGETICO DEGLI EDIFICI

È regolato da numerosi fenomeni fisici legati allo scambio termico, trasmissione del calore, tipologia e caratteristiche di generatori di calore ed elementi riscaldanti.

I principali fattori che determinano la quantità di energia necessaria a riscaldare un edificio sono quindi:

- Caratteristiche termoigrometriche dei materiali costituenti l'edificio;
- Efficienza impiantistica;
- Consumi elettrici ausiliari;
- Interazione edificio impianto
- Destinazione d'uso dell'edificio

La ricerca della massima efficienza e sostenibilità è rivolta al raggiungimento del massimo di ogni parametro impiegato.

### - L'INVOLUCRO EDILIZIO

È il principale responsabile del fabbisogno termico di un edificio.

La quantità di calore necessaria a riscaldare un edificio, e di conseguenza dei suoi consumi energetici, dipende unicamente dalle sue caratteristiche costruttive.

La potenza termica che deve essere fornita dal sistema di riscaldamento per mantenere un edificio alla temperatura di 20 °C è la stessa indipendentemente dal tipo di impianto.

A titolo di esempio:

Classe Energetica	Superficie riscaldata	Potenza termica richiesta
- Classe A	100 mq	4.050 W
- Classe G	100 mq	13.000 W

La potenza termica richiesta è in funzione dell'isolamento dell'edificio.

### - INTERAZIONE EDIFICIO IMPIANTO

La destinazione d'uso dell'immobile influisce sulle modalità di funzionamento dell'impianto:

- Continuo
- Intermittente

L'impianto deve essere quindi in grado di ottimizzare il suo rendimento in funzione del regime di funzionamento.

Gli edifici residenziali, così come gli uffici e le scuole, non sono occupati stabilmente e possono pertanto essere riscaldati in modo intermittente, quindi è utile ai fini del risparmio energetico il funzionamento intermittente (l'attuale normativa impone il funzionamento su più livelli di temperatura giornaliera).

L'abitazione deve mantenere costante la temperatura a regime di comfort (20 °C), solo quando c'è la presenza di persone.

## L'EFFICIENZA IMPIANTISTICA

È il rendimento di un impianto per:

- Produzione, dipende dalle caratteristiche del generatore di calore.
- Distribuzione, dipende dalle caratteristiche della rete idraulica.
- Emissione, dipende dalle caratteristiche dei caloriferi in ambiente.
- Regolazione, dipende dalla inerzia termica dei caloriferi.

### - Il RENDIMENTO DI PRODUZIONE

È in funzione delle caratteristiche del generatore di calore e dei corpi scaldanti.

Il rendimento di combustione per le caldaie a condensazione o il COP (coefficiente di prestazione) per le pompe di calore è influenzato dalla temperatura media dell'acqua dell'impianto, più questa temperatura media è bassa maggiore è il rendimento.

### - Il RENDIMENTO DI DISTRIBUZIONE

È in funzione della:

- lunghezza della rete di collegamento tra il generatore di calore e i corpi scaldanti (contenere il più possibile la lunghezza delle tubazioni e impiegare isolanti efficaci)

- temperatura media dell'acqua all'interno delle tubazioni e soprattutto del suo isolamento. (bassa temperatura: < 50 °C)

- dei consumi elettrici (pompe di circolazione, valvole motorizzate): più sono alti minore è il rendimento.

È inoltre opportuno impiegare elementi riscaldanti che operano a bassa temperatura:

- Fancoil
- Pannelli radianti
- Caloriferi/Radiatori

Tutti i radiatori di qualsiasi materiale sono adatti indifferentemente ad alta e bassa temperatura.

### - Il RENDIMENTO DI EMISSIONE

È caratteristico degli elementi riscaldanti.

La potenza resa viene indicata nei cataloghi delle aziende produttrici.

### - Il RENDIMENTO DI REGOLAZIONE

È in funzione di numerosi parametri, tra cui il principale è l'inerzia termica dell'impianto.

Un aspetto positivo dei radiatori è la possibilità di sfruttare gli innalzamenti di temperatura gratuiti (l'irraggiamento solare, la mezza stagione, il calore interno, la presenza di persone, ecc.) in quanto grazie alla bassa inerzia termica, interrompono istantaneamente l'erogazione del calore (regolazioni inefficaci per impianti a pannelli).

I sistemi a bassa inerzia termica seguono velocemente le variazioni di temperatura (interne ed esterne all'edificio) e hanno un rendimento di regolazione più elevato rispetto ai sistemi ad alta inerzia termica.

## RIEPILOGANDO:

IL FABBISOGNO DI ENERGIA DIPENDE DALL'EDIFICIO.

L'EROGAZIONE DELL'ENERGIA NECESSARIA DIPENDE DALL'IMPIANTO.

FONDAMENTALE IL RENDIMENTO OTTENUTO DALLA REGOLAZIONE DELL'EROGAZIONE DELL'ENERGIA.

# PRESTAZIONI di PANNELLI RADIANTI e RADIATORI

LA RICERCA CONDOTTA DALL'ING. FRANCESCO PAOLETTI È PUBBLICATA SUL SITO: [www.brem.it/riscaldare-risparmiare](http://www.brem.it/riscaldare-risparmiare)

## CONVENZIONE DI RICERCA

tra Dipartimento di Energetica "Sergio Stecco"  
UNIVERSITÀ DI FIRENZE e GLOBAL Srl.

Per il confronto sono state realizzate 2 camere di prova identiche per dimensioni, tipologia costruttiva e fabbisogno energetico equivalente a un edificio di circa 50/60 mq in classe A, una con pannelli radianti e una con radiatori, entrambe con pompa di calore da 7,50 kw. Il profilo termico delle due stanze di prova può considerarsi ragionevolmente comparabile ed essere quindi assunto come rappresentativo. Il confronto tra i consumi dei due sistemi è svincolato dal tipo di sorgente termica impiegata e si basa sull'effettivo calore entrante in ogni impianto.

## RISULTATI PRIMA CAMPAGNA DI PROVE

Funzionamento continuo 24 ore  
Funzionamento intermittente su 2 fasce orarie  
Funzionamento intermittente su 3 fasce orarie  
Regolazione pannelli radianti e radiatori on/off  
Temperatura mandata pannelli radianti 40°C  
Temperatura set-point pompe di calore 45°C

Energia totale consumata da 10/02 a 01/05  
Energia attiva Pannelli 861,898 KW  
Energia attiva Radiatori 638,999 KW

CONSUMO ENERGIA PANNELLI +34,9%

Giorni	Consumo Energia Pannelli kWh	Consumo Energia Caloriferi kWh	Consumo Energia DIFFERENZA Pannelli-Caloriferi
da 16/2 a 20/2	87,4	79,0	+10,6%
24/2 a 3/03	115,9	82,9	+39,8%
19/3 a 8/04	221,7	178,2	+24,4%

## RISULTATI SECONDA CAMPAGNA DI PROVE

Funzionamento continuo 24 ore  
Funzionamento intermittente su 3 fasce orarie  
Regolazione pannelli radianti on/off  
Regolazione radiatori on/off  
Temperatura mandata pannelli radianti 35°C  
Temperatura set-point pompe di calore 40°C

Energia totale consumata da 23/11 a 15/04  
Energia attiva Pannelli 1.756,700 KW  
Energia attiva Radiatori 1.591,400 KW

CONSUMO ENERGIA PANNELLI +10,4%

\*La seconda campagna di prove è eseguita con una impostazione volta ad ottimizzare il sistema radiante (funzionamento continuo a bassa temperatura) e contemporaneamente è stato scelto di alimentare i radiatori a temperatura più elevata (scelta penalizzante del rendimento e consumo della pompa di calore).

## I CONSUMI ENERGETICI dell'impianto con PANNELLI RADIANTI superano dal 10\*al 40% i consumi dell'impianto con RADIATORI

### CONFRONTO DELLE PRESTAZIONI DEI DUE IMPIANTI

I criteri di selezione dei dati, hanno identificato i cinque giorni che possono considerarsi rappresentativi dei differenti casi di conduzione dei due impianti in esame.

Si vede come i pannelli radianti abbiano consumi termici maggiori rispetto ai radiatori, con differenze comprese tra il 4 e il 44% nei giorni tipo dei periodi di test presi in considerazione. Le differenze sono minime con funzionamento continuo, mentre crescono sensibilmente nei test funzionamento a fasce orarie, confermando l'attitudine dei pannelli radianti ad operare in continuo per l'alta inerzia termica.

I consumi termici di ognuno dei due impianti sono stati ricavati dalle temperature di mandata e ritorno dell'acqua e alla temperatura ambiente previo scorporo degli assorbimenti elettrici.

I risultati hanno evidenziato un minor consumo termico dei radiatori, variabile dal 5% per conduzione continua (ottimale per i pannelli) fino al 40% per regimi fortemente discontinui.

La differenza tra i consumi elettrici e quelli termici dei due sistemi è esaltata man mano che si procede verso stagioni calde, in cui le ridotte richieste termiche incrementano l'incidenza sui consumi (elettrici) dei circolatori.

- In tutte le prove si è osservato che la temperatura media della stanza con pannelli radianti è superiore a quella della stanza con radiatori a causa dall'alta inerzia termica dei pannelli.
- Questo spiega anche perché il sistema a pannelli, nelle ore in cui il funzionamento è discontinuo, consuma generalmente più energia rispetto ai radiatori.

### ANALISI RISULTATI

L'analisi dei grafici e dei consumi di energia dei due sistemi mostra che in tutte le circostanze ed in tutti i regimi di funzionamento (continuo/intermittente):

- l'impianto a pannelli radianti consuma più energia rispetto all'impianto a radiatori
- i consumi elettrici del sistema radiante sono risultati sempre maggiori rispetto al sistema con radiatori
- a parità di set point di temperatura, e nonostante una regolazione più raffinata, la temperatura della camera riscaldata con i pannelli radianti tende ad essere sempre più elevata rispetto all'altra camera in particolare, durante il funzionamento a fasce orarie, si osserva una temperatura più alta anche con l'impianto spento che nella pratica corrisponde ai momenti in cui l'edificio non è abitato e non sussiste alcuna necessità di riscaldamento.

Questo è più evidente all'aumentare della temperatura esterna e dell'escursione termica giornaliera (a mezza stagione), condizione caratteristica della maggior parte delle ore di funzionamento degli impianti di riscaldamento nella gran parte del territorio italiano.

Anche nelle prove avvenute con l'acqua dei radiatori tarata a temperatura più alta, con forte penalizzazione del consumo, sono stati rilevati risparmi significativi nell'impianto a caloriferi (a dimostrazione che l'ottimizzazione del rendimento di produzione può essere vana se il sistema di emissione non è in condizione di massimizzare il rendimento di regolazione).

La tabella rappresenta i consumi termici ed elettrici complessivi nell'arco delle 24 ore dei cinque giorni tipo

GIORNO TIPO	Consumo PANNELLI kWh	Consumo Termico Tot. CALORIFERI kWh	DIFFERENZA consumo termico Pannelli-Caloriferi	Consumo Elettrico PANNELLI kWh	Consumo Elettrico CALORIFERI kWh	DIFFERENZA consumo elettrico Pannelli-Caloriferi
1	41,5	39,7	+ 4,5%	17,1	15,2	+12,5%
2	33,1	26,5	+24,9%	15,0	10,3	+45,6%
3	19,3	16,7	+15,6%	10,2	9,2	+10,9%
4	17,7	9,9	+78,8%	9,6	7,2	+33,3%
5	13,6	11,6	+17,2%	8,5	3,6	+236%

Oltre ai consumi termici sono risultati sempre maggiori anche i consumi elettrici del sistema radiante, a causa della più alta potenza di pompaggio necessaria alla circolazione di un quantitativo d'acqua maggiore rispetto al circuito radiatori.

## L'UTENTE PUÒ VALUTARE QUANTO PUÒ RISPARMIARE CON L'IMPIANTO A RADIATORI A FUNZIONAMENTO INTERROTTO

### SUGGERIMENTI

Negli edifici civili di nuova costruzione in classe A, caratterizzati da carichi termici ridottissimi e da bassissima inerzia termica, è evidente il maggior costo sia dell'impianto di riscaldamento a pannelli radianti che della sua gestione.

L'assenza di radiatori che occupano spazio sulle pareti è proposto come un vantaggio del riscaldamento a pavimento che risulta senza alcun impatto visivo: ma scegliere caloriferi belli, dalle forme originali e costruiti per lo spazio disponibile, può determinare vere architetture d'interni personalizzate dal colore o quasi invisibili se nelle finiture delle pareti.

Prendere la giusta decisione per riscaldare la propria abitazione è fondamentale: i vantaggi economici tanto millantati del sistema a pannelli radianti si è dimostrato non veritiero. La possibilità di spegnere e riaccendere il riscaldamento in maniera repentina e veloce (vero ed unico risparmio energetico), rimane ad oggi la soluzione più idonea.

# CONDIZIONI GENERALI DI VENDITA

## LISTINO PREZZI n°25 CON DECORRENZA DAL 1 MAGGIO 2025 - IVA ESCLUSA

### ORDINI

La vendita dei prodotti BREM, franco fabbrica, è regolata dalle condizioni generali qui di seguito elencate.

Eventuali variazioni avranno valore solo se confermate da noi per scritto.

Le conferme d'ordine vanno controllate al loro ricevimento; qualora entro 2 giorni di calendario non seguano altre comunicazioni saranno vincolanti per l'inizio della costruzione.

La Brem si riserva il diritto di compiere modifiche alle dimensioni e di effettuare consegne differenziate per il materiale disponibile a magazzino dal materiale in produzione.

I dati tecnici relativi ai caloriferi BREM, che comportano le tolleranze d'uso, sono da considerarsi indicativi e soggetti a variazioni.

### MODIFICHE ORDINI

Variazioni e annullamenti degli ordini sono soggetti alla nostra approvazione scritta.

I costi già sostenuti verranno addebitati al compratore.

Ordini con conferma a tempo determinato possono essere annullati o modificati solo entro il termine stabilito per la conferma.

Le modifiche, se possibili, da apportare ai caloriferi in fabbricazione sono soggette ad approvazione scritta BREM e comportano una maggiorazione del 40-70% del costo del calorifero; se le modifiche richieste non sono possibili, il calorifero verrà regolarmente finito e addebitato come da conferma d'ordine.

### PREZZI

I prezzi di vendita, che si intendono franco nostra sede, sono soltanto quelli risultanti dal listino della BREM s.r.l. indicato nel listino in corso di validità alla data dell'ordine.

### CONSEGNA DELLA MERCE

La consegna della merce, il cui termine riportato nella conferma d'ordine indica la data di carico, viene effettuata mediante affidamento della stessa dalla BREM s.r.l. a primaria società di trasporto per il successivo recapito al rivenditore. Le spese del trasporto sono a carico del rivenditore e la BREM declina ogni responsabilità in ordine al suddetto trasporto. In particolare, le parti dichiarano che la consegna delle merci è regolata dalla clausola EXW sede della Brem s.r.l. INCONTERMS 2000.

Nel caso in cui il rivenditore non prenda in carico la merce alla consegna, la Società si riserva il diritto di addebitare al rivenditore i costi e i rischi di magazzinaggio e il materiale verrà regolarmente fatturato.

BREM s.r.l. si riserva la scelta del tipo di imballaggio e gli imballi speciali saranno addebitati separatamente.

Il rivenditore, nel caso in cui la consegna dell'ordine venga ritardata dalla BREM per motivi tecnici o di qualità del prodotto, non potrà opporre alcun diniego alla consegna e al ritiro di quanto ordinato.

### RECLAMI E RESI

Reclami per danni causati dal trasporto o merci mancanti devono essere evidenziati subito al ricevimento firmando con specifica riserva la bolla di consegna e informando per scritto la Brem s.r.l. entro due giorni.

Reclami per difetti di fabbricazione visibili devono essere tempestivamente segnalati al momento dell'apertura dell'imballo e prima del montaggio. Nessun reso sarà accettato senza il nostro consenso scritto.

I radiatori danneggiati o con difetti di fabbricazione, essendo costruiti su misura, devono rientrare presso la sede per gli opportuni interventi di ripristino.

### CONDIZIONI DI PAGAMENTO

Quando non diversamente stabilito, le fatture sono da pagare entro 30 giorni al netto e senza sconto.

In caso di ritardato pagamento verranno richiesti, oltre alle spese, gli interessi di mora previsti dal D. Lgs. 09.10.2002, n. 231. La merce consegnata rimane di proprietà della BREM sino a pagamento avvenuto; in caso contrario la Brem s.r.l. si riserva il diritto di ritirare la merce non pagata.

### INADEMPIMENTO

Il mancato ritiro da parte del rivenditore della merce ordinata, così come la morosità nei pagamenti, anche relativamente ad una sola scadenza, darà alla Società il diritto di chiedere l'immediato pagamento dell'intero residuo prezzo della merce in una unica soluzione ed autorizza la BREM s.r.l. alla emissione di tratte a vista per il corrispondente importo dovuto a saldo, oltre spese e interessi moratori come prima individuati.

A sanatoria avvenuta della morosità, la BREM s.r.l., su richiesta del rivenditore, potrà riprendere le forniture eventualmente interrotte ai prezzi di listino in vigore alla data di ripresa delle stesse.

### TOLLERANZE

I caloriferi Brem sono eseguiti con la massima cura; i procedimenti di lavorazione, le saldature fino a 1085° causano al prodotto dilatazioni e allungamenti con tolleranze di  $\pm 3\text{mm}$

### GARANZIA

I caloriferi BREM sono garantiti tre anni, con decorrenza dal giorno di spedizione, a condizione che siano stati usati in modo appropriato e il montaggio sia stato eseguito a regola d'arte.

Gli accessori sono garantiti per due anni.

I pezzi che durante il periodo di garanzia, risultano difettosi per errori di materiale o di fabbricazione, dietro vostra richiesta scritta saranno riparati gratuitamente Franco vostra destinazione senza apportare modifiche strutturali o di colorazione.

I materiali difettosi che tornano di nostra proprietà devono essere imballati con adeguate protezioni e spediti presso la nostra sede tramite il nostro spedizioniere, previa autorizzazione scritta; eventuali danni di trasporto per imballo insufficiente saranno addebitati.

Sono esclusi dalla garanzia i prodotti non pagati e quelli con danni causati da:

- stoccaggio dei caloriferi in luoghi non idonei (senza imballo di plastica e/o in luoghi umidi)

- montaggio e utilizzo non appropriato,

- manutenzione non corretta: la pulizia con detergenti aggressivi può rovinare la superficie che si mantiene pulita con un panno umido e lucida se trattata con cera d'auto.

- installazione effettuata da personale non qualificato,

- riparazioni o modifiche anche di colorazioni eseguite senza l'autorizzazione scritta di Brem,

- aggiunta di sostanze chimiche aggressive nell'acqua dell'impianto di riscaldamento,

- svuotamento periodico dell'impianto,

- collegamento ad impianti con vaso d'espansione aperto o ad impianti di trattamento delle acque o in sovraccarico,
- pressione d'esercizio superiore a quella riportata nei dati tecnici,

- allacciamento all'impianto idro-sanitario,

- utilizzo di canapa sui collegamenti provvisti di guarnizioni o-ring.

### LEGGE APPLICABILE

Per quanto non previsto e in caso di controversia, legge applicabile a ciascuna fornitura è la legge italiana.

### FORO COMPETENTE

In caso di controversia è espressamente riconosciuta la sola competenza del Tribunale di Bergamo (ITALY).



**BREM**  
CALORIFERI PER L'ARCHITETTURA

