

DONNEES TECHNIQUES CROSS-Q

ENTRAXE RACCORDEMENTS ET FIXATIONS (avec cadres superposés)

sèche-serviettes

CrossFRAME

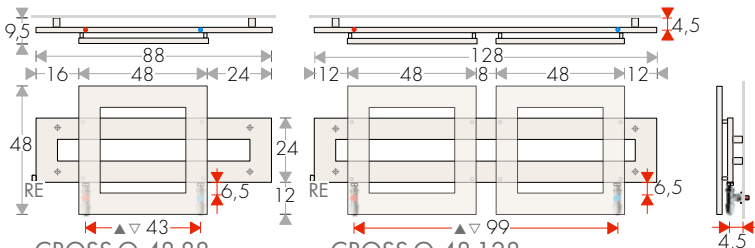

RE: Manchon pour
Résistance Electrique
(sur demande)

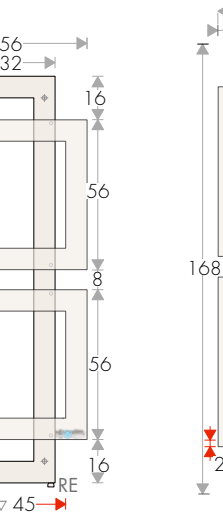
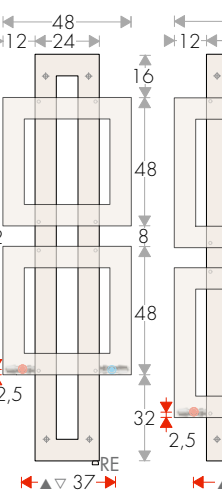
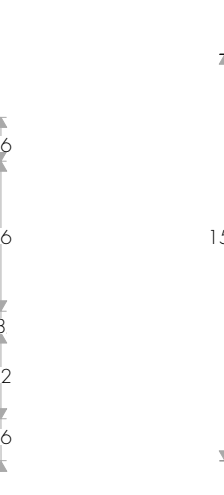
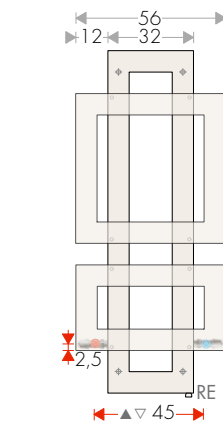
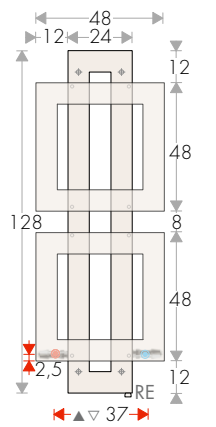
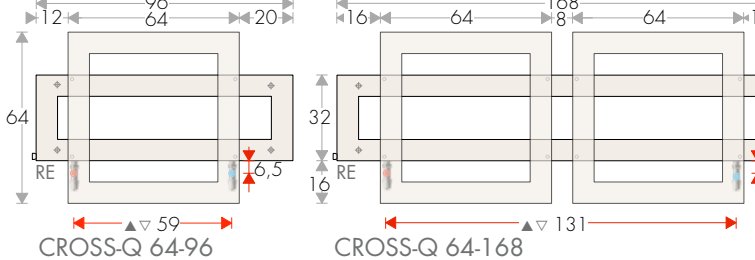
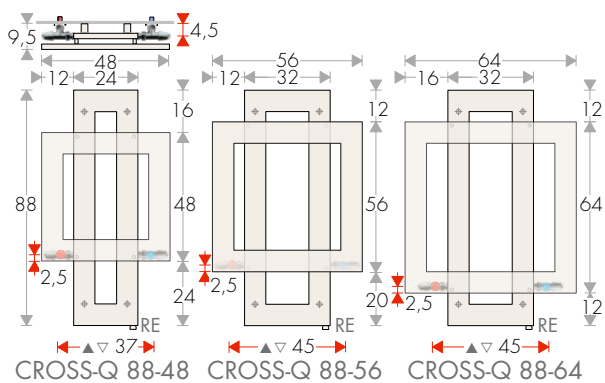
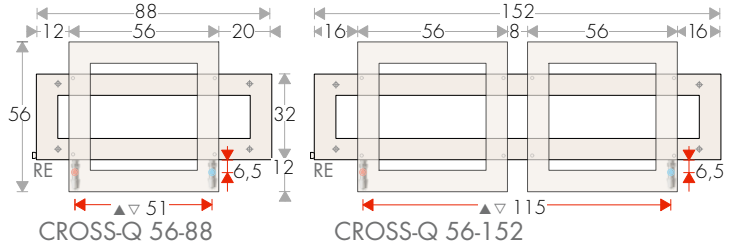
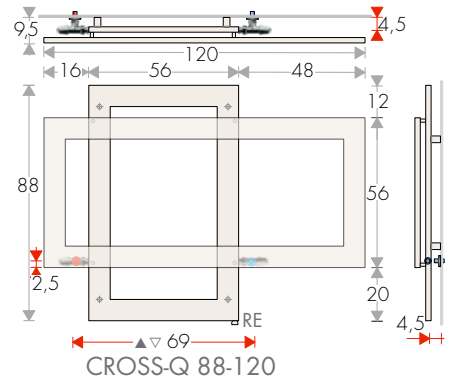

POSITION DES CONSOLES

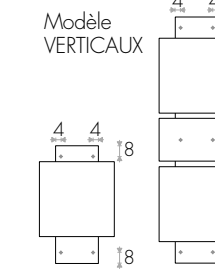
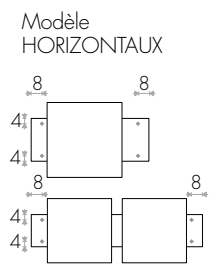

ENTRAXE RACCORDS avec ROBINETS INVERSES

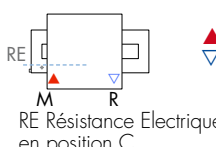

▲ M départ
▼ R retour

