

DONNEES TECHNIQUES CROSS-R/RV

ENTRAXE RACCORDEMENTS ET FIXATIONS (avec cadres superposés)

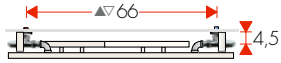

CROSS-R 70-80

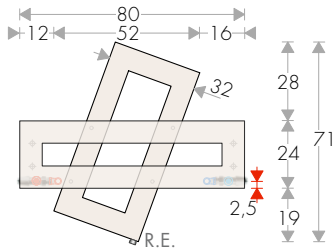
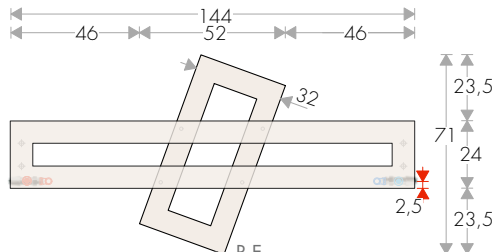

CROSS-R/RD 70-144

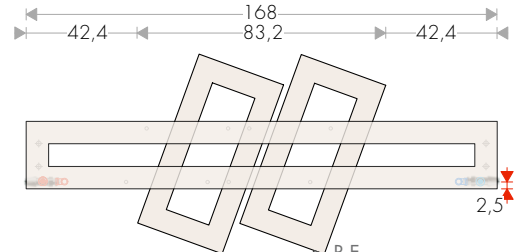

CROSS-R2 70-168

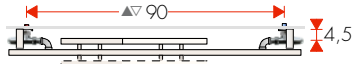
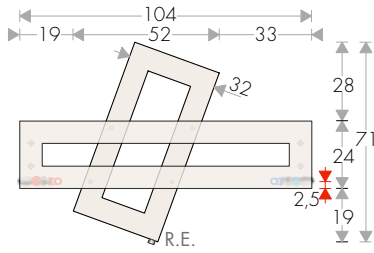

CROSS-R/RD 70-104

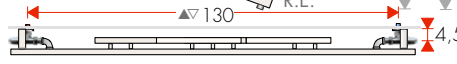
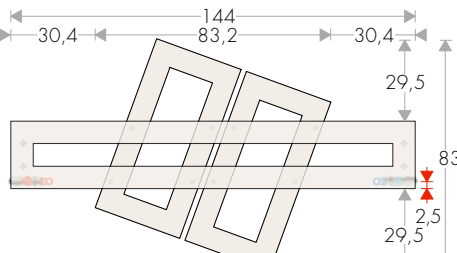

CROSS-R2 83-144

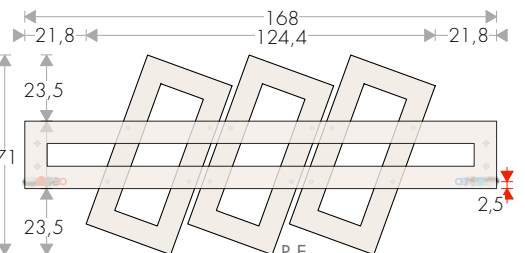

CROSS-R3 70-168

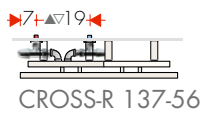
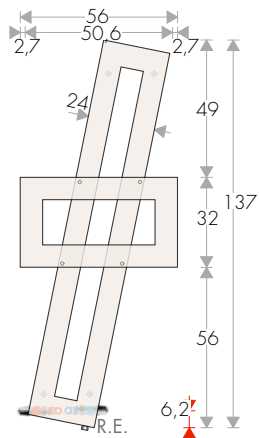

CROSS-R 137-56

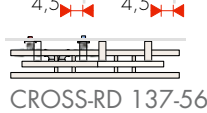
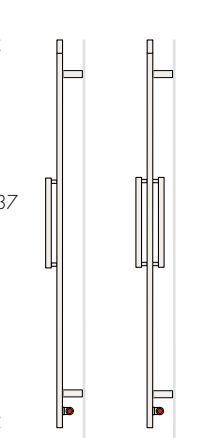

CROSS-RD 137-56

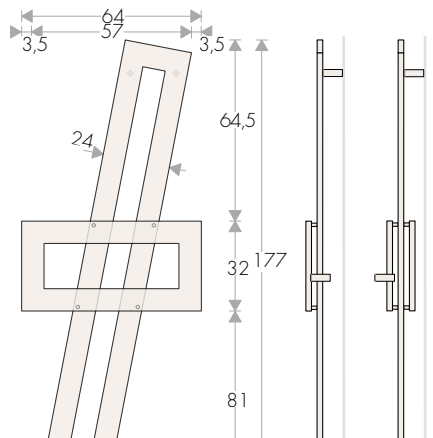

CROSS-R 177-64

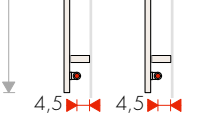
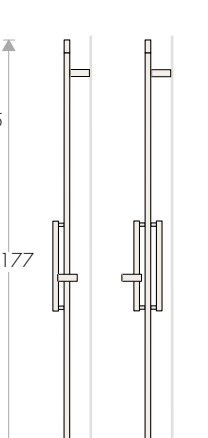

CROSS-RD 177-64

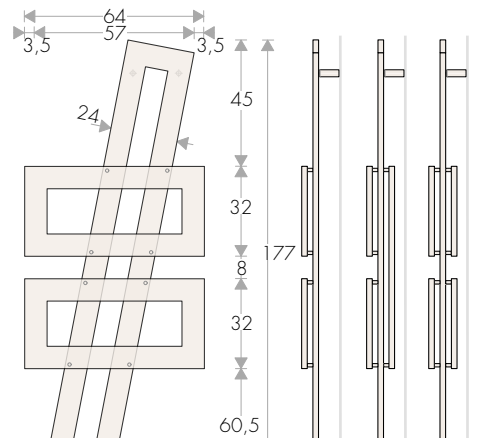

CROSS-2R 177-64

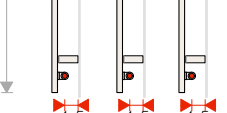

CROSS-3R 177-64

CROSS-4R 177-64

RE: Manchon pour Résistance
Electrique (sur demande)

