

# CROSS CROM WITH OVERLAPPING SQUARES

PRICE FROM 1.07.2022 **+15%**

CROSS CROM is a chrome-plated version, for attractive compositions of no more than

three overlapping elements. Can be used as a towel-heater, or simply a

decorative feature in any room. *design Luigi Brembilla*

## DIMENSIONS

Width: 48/56/64/88/96/120/128/152/168 cm

Height: 48/56/64/88/128/152/168/184 cm

Depth: 6 cm

Depth from wall: 9,5 cm

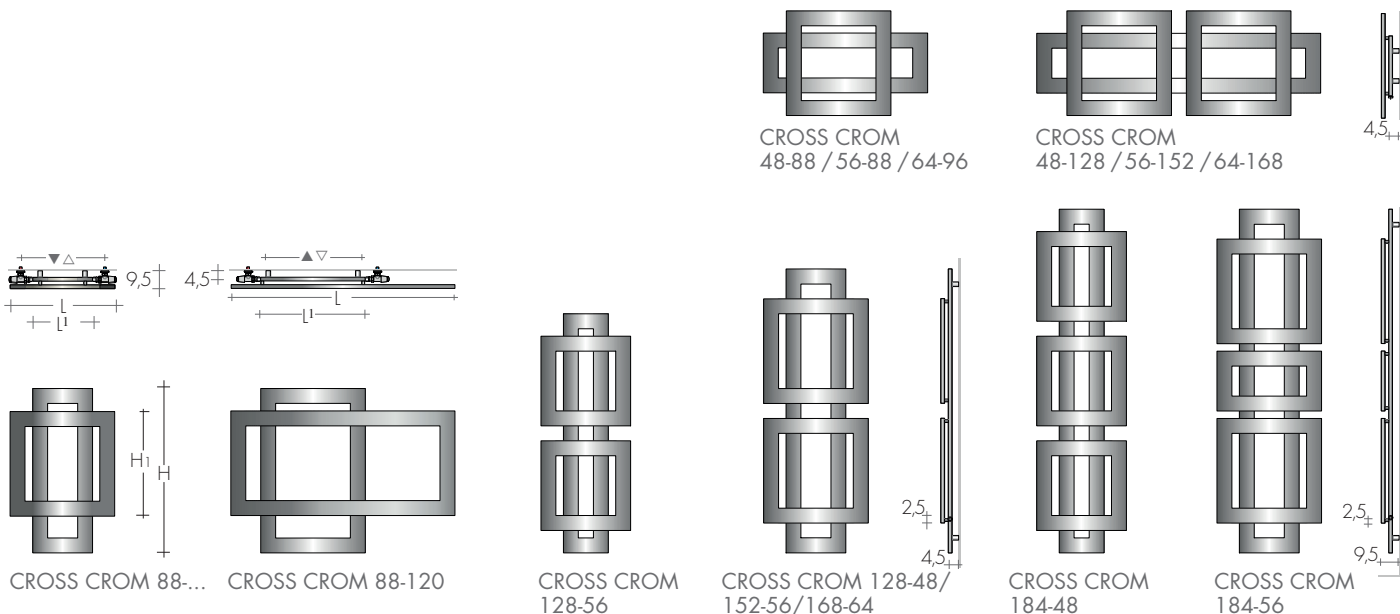

MODEL	chrome-plated		EN 442		▲▽ t.c. cm	Height H (Hi) cm	Width L (Li) cm	Weight M Kg	Volume V dm <sup>3</sup>	MIXED version (EHE cl.II) with sleeve and: cable <sup>o</sup> digital thermostat		
	HL cm	standard €	Δt 50 K watt	Δt 30 K watt						€	W	€
CROSS CROM 48-88	48-88	1482,40	339	339	43	48 (24)	88 (48)	7,9	4,8	108,80	250	171,10
CROSS CROM 48-128	48-128	2057,90	533	533	99	48 (24)	128 (104)	12,8	7,7	112,70	500	175,00
CROSS CROM 56-88	56-88	1543,40	369	369	51	56 (32)	88 (56)	8,6	5,2	110,80	400	173,10
CROSS CROM 56-152	56-152	2230,80	648	648	115	56 (32)	152 (120)	15,6	9,4	114,60	650	176,90
CROSS CROM 64-96	64-96	1674,30	413	413	59	64 (32)	96 (64)	9,7	5,9	110,80	400	173,10
CROSS CROM 64-168	64-168	2333,20	758	758	131	64 (32)	168 (136)	17,6	10,7	118,80	800	181,10
CROSS CROM 88-48	88-48	1454,90	339	339	37	88	48 (24)	7,9	4,8	110,80	400	173,10
CROSS CROM 88-56	88-56	1514,40	369	369	45	88	56 (32)	8,6	5,2	110,80	400	173,10
CROSS CROM 88-120	88-120	1812,40	531	531	69	88	120 (56)	12,4	7,5	112,70	500	175,00
CROSS CROM 128-48	128-48	2041,60	511	511	37	128	48 (24)	12,8	7,7	112,70	500	175,00
CROSS CROM 128-56	128-56	2131,60	538	538	45	128	56 (32)	13,5	8,2	112,70	500	175,00
CROSS CROM 152-56	152-56	2211,60	621	621	45	152	56 (32)	15,6	9,4	114,60	650	176,90
CROSS CROM 168-64	168-64	2307,90	733	733	45	168	64 (32)	18,7	11,3	114,60	650	176,90
CROSS CROM 184-48	184-48	2934,80	712	712	37	184	48 (24)	18,7	11,3	114,60	650	176,90
CROSS CROM 184-56	184-56	3060,70	880	880	45	184	56 (32)	20,0	12,1	121,90	900	184,20

(Δt 40K = W Δt 50Kx0,755) <sup>o</sup>Radio frequency chronothermostat p.227

## STANDARD PRODUCTION

Chrome-plated B35 brackets and finishing

Tolerance ± 3mm - Air vent ø 1/8"

MAXIMUM OPERATING PRESSURE 4 BAR

## PRODUCTION ON REQUEST

Made-to-measure dimensions

B70 brackets for 13 cm depth from wall

Electric version e.Cross Crom, page 243

## STANDARD FITTING

REG ø 1/2"

On request fitting ø 3/8"

Special fittings, page 287

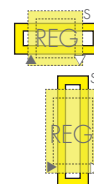

TAPPING CENTRES

Horizontal Models

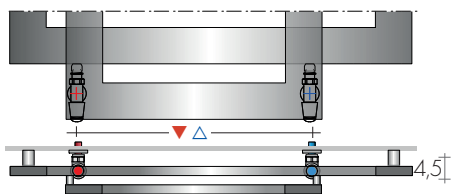

Vertical Models

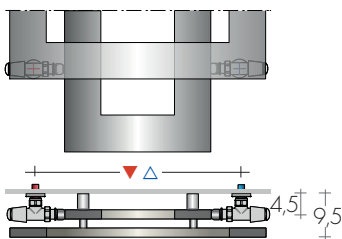

TECHNICAL DATA p.66

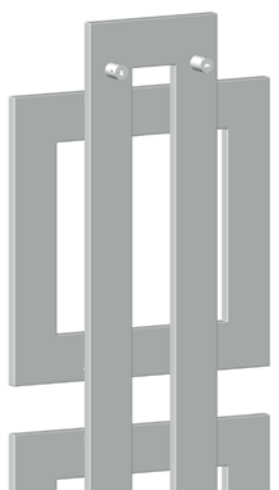

**FIXINGS**  
Brackets included  
position page 66

RECOMMENDED VALVES

as standard at the rear of the radiator

CHROME PLATED VALVES KIT WITH:

- n°2 Valves with O-ring Tangs
- n°2 Fittings (multilayer ø16, copper ø12,14)
- n°2 Round washers

On request: Polished stainless tube cover  
(to be cut to right size) Art. CA18 10,80€

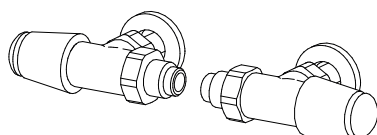

REVERSE TON VALVES KIT  
page 277

Art. KVR 119,20€

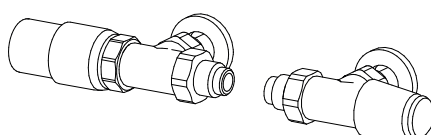

REVERSE TON VALVES KIT with  
THERMOSTATIC head Art. KTR 165,50€

REMOTE FITTINGS Art. REM 36,60€  
tapping centres ▲▼ L<sup>1</sup> - 6cm



2,5±

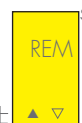

REMOTE VALVES ASSEMBLY KIT p. 281 with:  
- n°2 Fittings (multilayer ø16, copper ø12,14)

REMOTE TON VALVES ASSEMBLY KIT  
Art. KVG 153,60€

REMOTE TON VALVES ASSEMBLY KIT with  
THERMOSTATIC head Art. KVG T 199,80€



CROSS CROM 88-120