

CROSS-Q WITH OVERLAPPING SQUARES

PRICE FROM 1.07.2022 **+15%**

Large, variously assembled, rectangular tubes are used to produce CROSS-Q.

Innovative radiators thanks to 90° corners and strong geometric shapes (squares and

rectangles) sitting on top of each other.

DIMENSIONS

Width: 48/56/64/100/116 cm

Height: 48/56/64/184/208/224/228 cm

Depth: 6 cm

Depth from wall: 9,5 cm

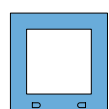
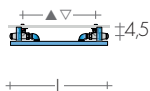

CROSS-Q 48-48
CROSS-Q 56-56
CROSS-Q 64-64

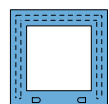

CROSS-QP 48-48
CROSS-QP 56-56
CROSS-QP 64-64

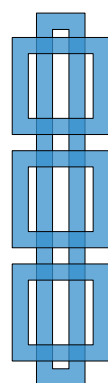
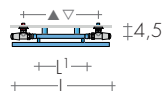

CROSS-Q 184-48
CROSS-Q 208-56
CROSS-Q 224-64

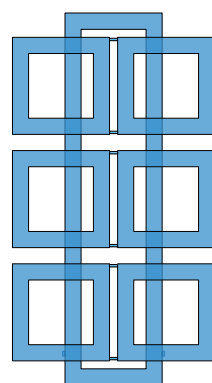
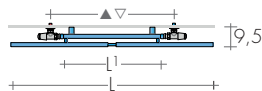

CROSS-Q 184-100
CROSS-Q 208-116

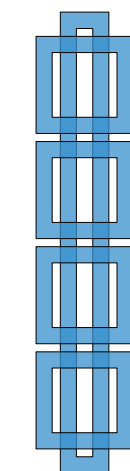

CROSS-Q 228-48

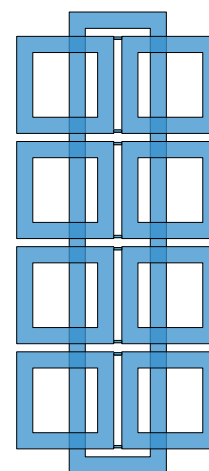

CROSS-Q 228-100



MODEL	H/L cm	white sablé standard €	EN 442		▲ ▽ t.c. cm	Height H (Hi) cm	Width L (Li) cm	Weight M Kg	Volume V dm³	MIXED version (EHE cl.II) with sleeve and: cable ^o digital thermostat		
			Δt 50 K watt	Δt 30 K watt						€	W	€
CROSS-Q 48-48	48-48	312,40	176	95	34	48	48	3,5	2,1	-	-	-
CROSS-QP 48-48	48-48	404,00	272	147	34	48	48	5,7	3,2	108,80	250	171,10
CROSS-Q 56-56	56-56	343,60	211	114	42	56	56	4,1	2,5	108,80	250	171,10
CROSS-QP 56-56	56-56	438,10	326	176	42	56	56	6,9	3,9	110,80	400	173,10
CROSS-Q 64-64	64-64	365,20	246	133	50	64	64	4,8	2,9	108,80	250	171,10
CROSS-QP 64-64	64-64	458,90	381	206	50	64	64	8,1	4,5	110,80	400	173,10
CROSS-Q 184-48	184-48	1085,10	890	470	37	184 (160)	48 (24)	18,7	11,3	121,90	900	177,40
CROSS-Q 184-100	184-100	1766,00	1442	761	61	184 (160)	100 (48)	30,2	18,3	138,60	1500	184,20
CROSS-Q 208-56	208-56	1138,40	1055	557	37	208 (184)	56 (24)	22,1	13,4	-	-	-
CROSS-Q 208-116	208-116	1859,60	1689	892	61	208 (184)	116 (48)	35,4	21,5	138,60	1500	200,90
CROSS-Q 224-64	224-64	1192,60	1203	635	37	224 (200)	64 (24)	25,2	15,3	129,20	1200	191,50
CROSS-Q 228-48	228-48	1308,00	1119	593	37	228 (204)	48 (24)	24,0	14,6	129,20	1200	191,50
CROSS-Q 228-100	228-100	2208,90	1818	964	61	228 (204)	100 (48)	39,1	23,7	-	-	-

► Ready Stock

Δt 40K = W Δt 50K x 0,755

^oRadio frequency chronothermostat p.227

STANDARD PRODUCTION

White "sablé" paintwork - B.. brackets

Tolerance ± 3mm - Air vent ø 1/8"

MAXIMUM OPERATING PRESSURE 4 BAR

PRODUCTION ON REQUEST

Paintwork to Brem color list with colored

brackets B.. +15/25%

Electric version e.Cross-Q, p.232

STANDARD FITTING

REG ø 1/2"

On request fitting ø3/8"

Special fittings, page 286



TAPPING CENTRES

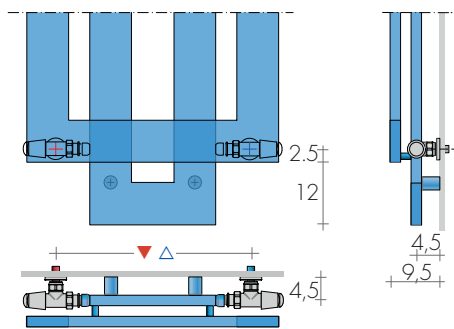

TECHNICAL DATA and brackets position p.66

FIXINGS

Brackets included:
B35 for CROSS-Q
B15 for CROSS-QP



CROSS-Q 184-100

RECOMMENDED VALVES

as standard at the rear of the radiator

CHROME PLATED VALVES KIT WITH:

- n°2 Valves with O-ring Tangs
- n°2 Fittings (multilayer ø16, copper ø12,14)
- n°2 Round washers

On request: Polished stainless tube cover
(to be cut to right size) Art. CA18 10,80€

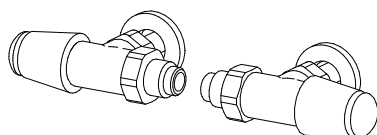

REVERSE TON VALVES KIT
page 277

Art. KVR 119,20€

QUADRA COLORED VALVES

page 279

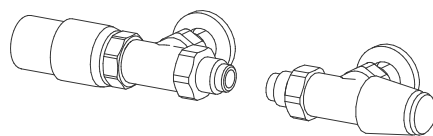

REVERSE TON VALVES KIT with
THERMOSTATIC head

Art. KTR 165,50€

REMOTE FITTINGS

Art. REM 36,60€

tapping centres ▲ ▽ L¹ - 6cm

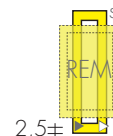
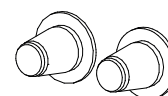

REMOTE VALVES ASSEMBLY KIT p. 281 with:
- n°2 Fittings (multilayer ø16, copper ø12,14)

REMOTE TON VALVES ASSEMBLY KIT

Art. KVG 153,60€

REMOTE TON VALVES ASSEMBLY KIT with
THERMOSTATIC head Art. KVG T 199,80€