

CROSS-Q TOWEL HEATERS WITH OVERLAPPING SQUARES

PRICE FROM 1.07.2022 **+15%**

Cross towel heaters can be provided in CROSS-Q version, with overlapping squares, to obtain a towel heaters 10 cm in depth only. Innovative element thanks to 90° corners and strong geometric shapes. Finishes can be chosen from the rich Brem color list

DIMENSIONS

Width: 48/56/64/88/96/120/128/152/168 cm

Height: 48/56/64/88/128/152/168/184 cm

Depth: 6 cm

Depth from wall: 9,5 cm

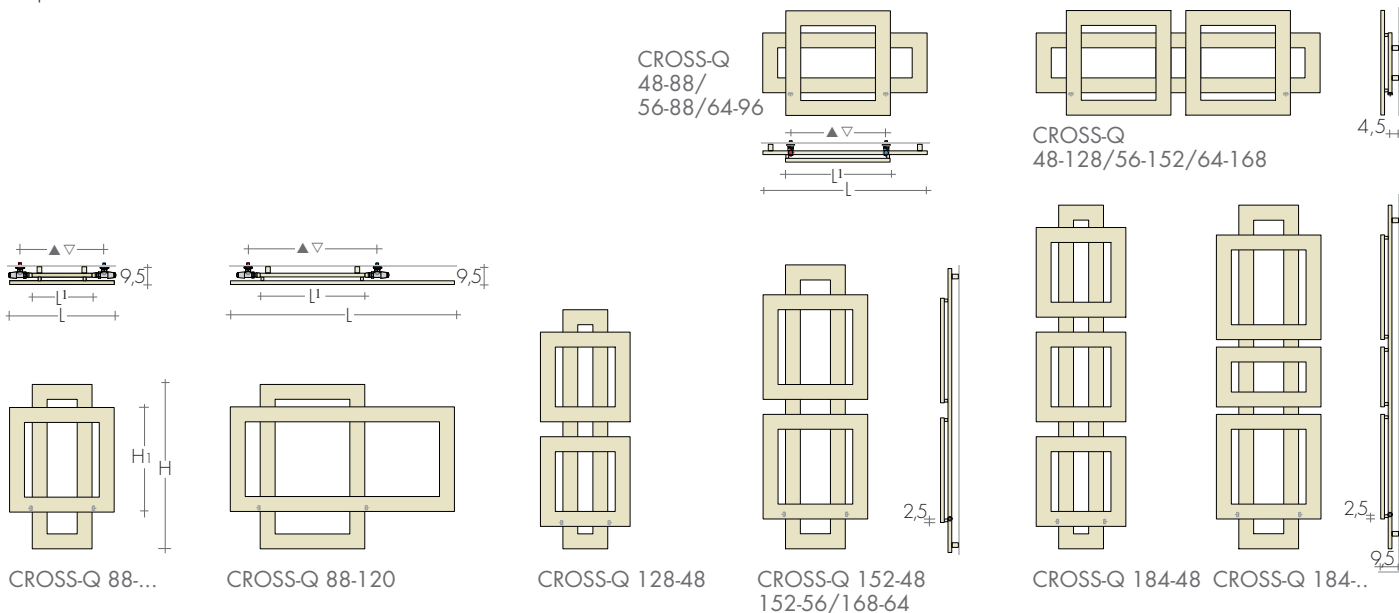

MODEL	HL cm	white sablé standard €	EN 442		▲▽ t.c. cm	Height H (H1) cm	Width L (Li) cm	Weight M Kg	Volume V dm³	MIXED version (EHE cl.II) with sleeve and: cable ^o digital thermostat		
			Δt 50 K watt	Δt 30 K watt						€	W	€
CROSS-Q	48-88	605,90	▶ 394	208	43	48 (24)	88 (48)	7,9	4,8	110,80	400	173,10
CROSS-Q	48-128	841,10	▶ 635	335	99	48 (24)	128 (104)	12,8	7,7	114,60	650	176,90
CROSS-Q	56-88	630,90	▶ 429	227	51	56 (32)	88 (56)	8,6	5,2	110,80	400	173,10
CROSS-Q	56-152	911,80	▶ 772	408	115	56 (32)	152 (120)	15,6	9,4	118,80	800	181,10
CROSS-Q	64-96	684,20	▶ 480	253	59	64 (32)	96 (64)	9,7	5,9	112,70	500	175,00
CROSS-Q	64-168	953,90	▶ 892	471	131	64 (32)	168 (136)	17,6	10,7	121,90	900	177,40
CROSS-Q	88-48	594,70	▶ 394	208	37	88	48 (24)	7,9	4,8	110,80	400	173,10
CROSS-Q	88-56	619,00	▶ 429	227	45	88	56 (32)	8,6	5,2	110,80	400	173,10
CROSS-Q	88-120	740,90	▶ 617	326	69	88	120 (56)	12,4	7,5	114,60	650	176,90
CROSS-Q	128-48	834,70	▶ 623	329	37	128	48 (24)	12,8	7,7	114,60	650	176,90
CROSS-Q	128-56	871,20	▶ 656	346	45	128	56 (32)	13,5	8,2	114,60	650	176,90
CROSS-Q	152-48	877,60	▶ 673	355	37	152	48 (24)	13,8	8,4	114,60	650	176,90
CROSS-Q	152-56	904,00	▶ 757	400	45	152	56 (32)	15,6	9,4	118,80	800	181,10
CROSS-Q	168-64	966,10	▶ 875	462	45	168	64 (32)	18,7	11,3	121,90	900	184,20
CROSS-Q	184-48	1085,10	▶ 890	470	37	184	48 (24)	18,7	11,3	121,90	900	184,20
CROSS-Q	184-56	1131,60	▶ 956	505	45	184	56 (32)	20,0	12,1	121,90	900	184,20
CROSS-Q	184-64	1179,50	▶ 1038	548	45	184	64 (32)	21,8	13,2	121,90	900	184,20

▶ Ready Stock

(Δt 40K = W Δt 50Kx0,755)

^oRadio frequency chronothermostat p.227

STANDARD PRODUCTION

White "sablé" paintwork - B35 brackets

Tolerance ± 3 mm - Air vent ø 1/8"

MAXIMUM OPERATING PRESSURE 4 BAR

PRODUCTION ON REQUEST

Paintwork to Brem color list with

colored B35 brackets

+15/25%

Electric version e.Cross-Q, page 244

STANDARD FITTING

REG ø 1/2"

On request fitting ø3/8"

Special fittings, page 287

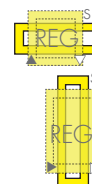

TAPPING CENTRES

Horizontal Models

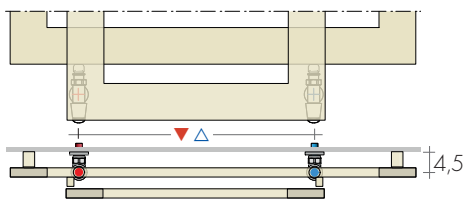

Vertical Models

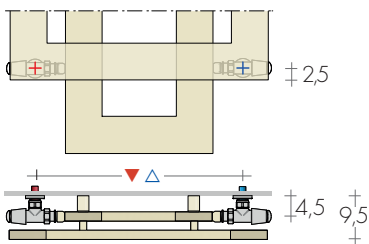

TECHNICAL DATA page 66

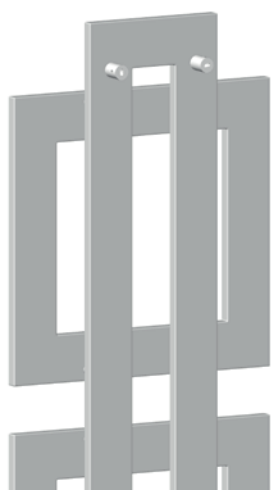

FIXINGS
Brackets included
position page 66



CROSS-Q 184-48

RECOMMENDED VALVES

as standard at the rear of the radiator

CHROME PLATED VALVES KIT WITH:

- n°2 Valves with O-ring Tangs
- n°2 Fittings (multilayer ø16, copper ø12,14)
- n°2 Round washers

On request: Polished stainless tube cover
(to be cut to right size) Art. CA18 10,80€

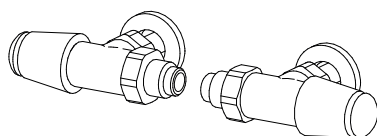

REVERSE TON VALVES KIT
page 277

Art. KVR 119,20€

QUADRA COLORED VALVES page 279

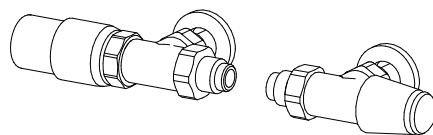

REVERSE TON VALVES KIT with
THERMOSTATIC head

Art. KTR 165,50€

REMOTE FITTINGS Art. REM 36,60€
tapping centres ▲▼ L¹ - 6cm

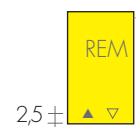

REMOTE VALVES ASSEMBLY KIT p. 281 with:
- n°2 Fittings (multilayer ø16, copper ø12,14)

REMOTE TON VALVES ASSEMBLY KIT
Art. KVG 153,60€

REMOTE TON VALVES ASSEMBLY KIT with
THERMOSTATIC head Art. KVG T 199,80€