

design Luigi Brebbia

Essential, light, and eclectic in design, CUBICO is the Brem towel warmer

where the minimalism and elegance of the radiating plate are enhanced by the

playful and versatile insertion of a cubic or parallelepiped shaped support.

DIMENSIONS

Length: 53,5 cm

Heights: 88 / 95 / 124 / 145 / 167 cm

Depth: 10,5 cm

Depth from wall: 14 cm

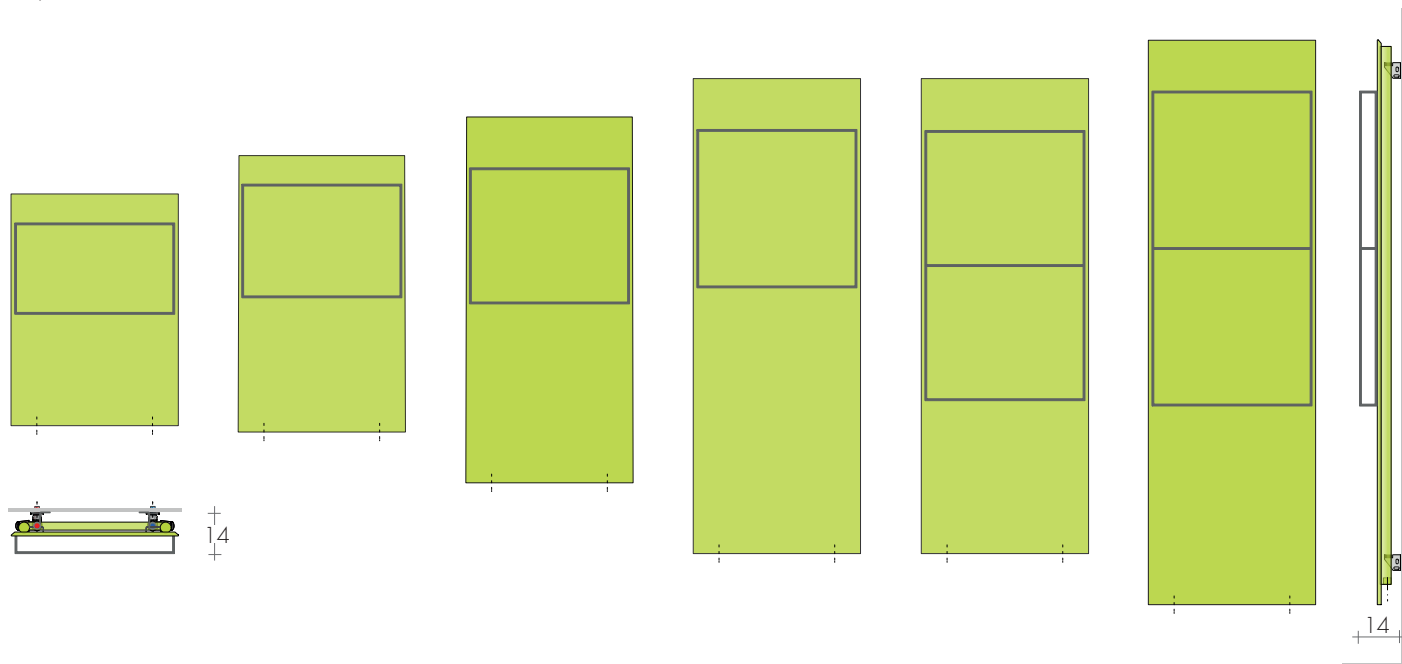

CUBICO 88-53

CUBICO 95-53

CUBICO 124-53

CUBICO 145-53

CUBICO-2 145-53

CUBICO-2 167-53

MODEL	HL cm	white sablé standard €	EN 442		▲ ▽ t.c. cm	Height H cm	Width L cm	Weight M Kg	Volume V dm ³	MIXED version*(EHE cl.II):		
			Δt 50 K watt	Δt 30 K watt						cable ^o €	digital thermostat W €	
CUBICO	88-53	743,10	408	210	37	88	53,5	11,9	4,2	110,80	400	152,20
CUBICO	95-53	808,20	490	252	37	95	53,5	13	4,6	112,70	500	154,10
CUBICO	124-53	879,40	653	336	37	123,5	53,5	17,3	6,1	114,60	650	156,00
CUBICO	145-53	953,60	775	398	37	145	53,5	20,6	7,3	118,80	800	160,20
CUBICO-2	145-53	981,60	775	398	37	145	53,5	21,5	7,3	118,80	800	160,20
CUBICO	167-53	1043,70	897	461	37	166,5	53,5	24,7	8,4	121,90	900	163,30

▶ Ready in stock Δt 40K = W Δt 50K x 0,755 ^oRadio frequency chronothermostat p.227

TOWEL BAR MANT: STANDARD COLORS

- white sablé SB 9016
- quartz grey SB 7039
- jet black SB 9005
- same color ordered with the radiator

In one paintwork to Brem color list different from the radiator extra 35,80€



MIXED VERSION*
with valves in sight
height = H-7cm
t.c. = ▲ ▽ 5 cm

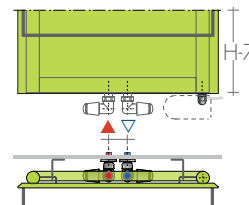

STANDARD PRODUCTION

White "sablé" paintwork - white EOS brackets
Tolerance ± 3mm - Air vent ø 1/2"

MAXIMUM OPERATING PRESSURE 6 BAR

PRODUCTION ON REQUEST

Paintwork to Brem list with colored brackets
(white back side and manifolds) +15/25%
Back and manifolds same color as radiator 132€

STANDARD FITTING

EG ø 1/2"
Electrical version, e.Cubico p. 254
BREM valves, page 273



TAPPING CENTRES

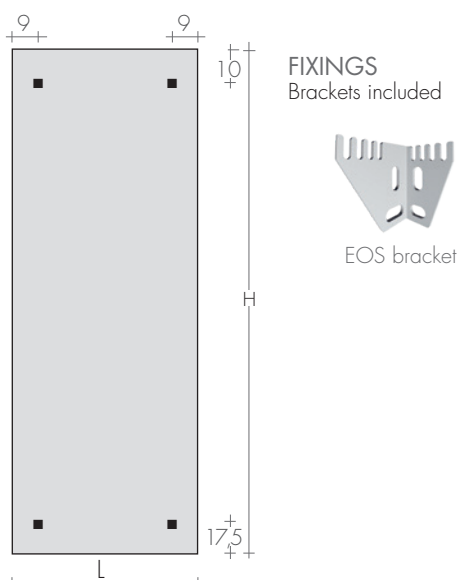
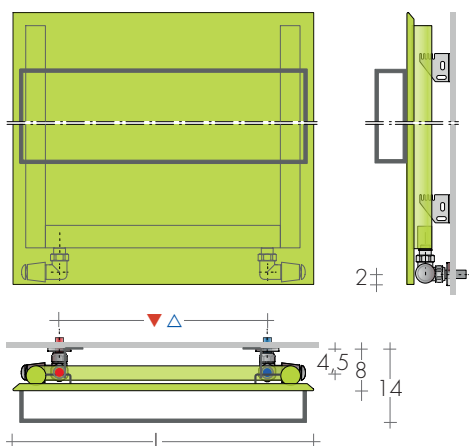

CUBICO-2 145-53

RECOMMENDED VALVES

as standard at the rear of the radiator

CHROME PLATED VALVES KIT WITH:

- n°2 Valves with O-ring Tangs
- n°2 Fittings (multilayer ø16, copper ø12,14)
- n°2 Round washers

On request: Polished stainless tube cover (to be cut to right size) Art. CA18 10,80€

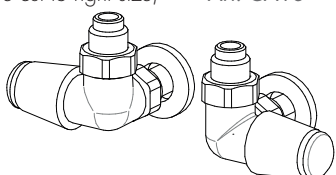

SIDE CONTROL TON VALVES KIT nickel-plated chrome-plated handwheel Art. KVLN 91,80€

SIDE CONTROL TON VALVES KIT chrome-plated page 277 Art. KVL 130,90€

SIDE CONTROL QUADRA VALVES page 279 chrome-plated Art. KQL 166,30€ extra for BREM color list 46,40€

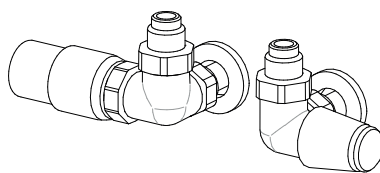

SIDE CONTROL TON VALVES KIT nickel-plated with THERMOSTATIC head Art. KTLND 135,00€

SIDE CONTROL TON VALVES KIT chrome-plated with THERMOSTATIC head Art. KTLD 177,10€

REMOTE FITTINGS Art. REM 36,60€ tapping centres (Panel H - 7cm): ▲▽ L-8,5cm

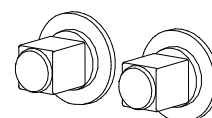

2,5€



REMOTE VALVES ASSEMBLY KIT p. 281 with: - n°2 Fittings (multilayer ø16, copper ø12,14)

REMOTE QUADRA VALVES ASSEMBLY KIT Art. KQG 167,70€

REMOTE TON VALVES ASSEMBLY KIT with THERMOSTATIC head Art. KVGT 199,80€