

FREE is a rectangular tube heating towel bar that can be fixed at will to the wall.

Free towel heater can be used on its own or combined with models protruding max 6 cm

from wall (E.g. Clak, Lamina, S-Platt, Egon, Cross-V, Kuadrum o Form).

DIMENSIONS

Widths: 64/84/104/124/144 cm

Heights: 24 cm

Depths: 12cm



FREE 24-64

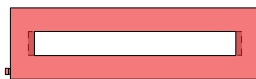

FREE 24-84

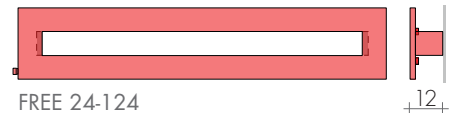

FREE 24-124

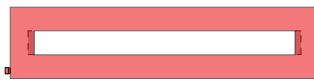
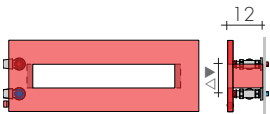

FREE 24-104

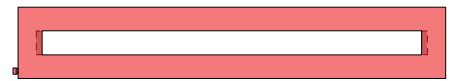

FREE 24-144

| MODEL | HxL cm | white sablé standard € | EN 442 Δt 50 K watt | EN 442 Δt 30 K watt | ▲ ▽ t.c. cm | Height H cm | Width L cm | Weight M Kg | Volume V dm³ | MIXED version (EHE cl.II) with sleeve and: cable digital thermostat | | |
|-------|-----------|------------------------------|---------------------------|---------------------------|-------------------|-------------------|------------------|-------------------|--------------------|--|-----|--------|
| | | | | | | | | | | € | W | € |
| FREE | 24-64 | 340,60 | 158 | 83 | 10 | 24 | 64 | 3,0 | 1,9 | 108,80 | 250 | 171,10 |
| FREE | 24-84 | 366,90 | 202 | 106 | 10 | 24 | 84 | 3,9 | 2,4 | 108,80 | 250 | 171,10 |
| FREE | 24-104 | 395,80 | 246 | 129 | 10 | 24 | 104 | 4,7 | 2,9 | 108,80 | 250 | 171,10 |
| FREE | 24-124 | 442,50 | 290 | 153 | 10 | 24 | 124 | 5,5 | 3,5 | 110,80 | 400 | 173,10 |
| FREE | 24-144 | 500,20 | 334 | 176 | 10 | 24 | 144 | 6,4 | 4,0 | 110,80 | 400 | 173,10 |

▶ Ready Stock (Δt 40K = W Δt 50K x 0,755) ⚡ Radio frequency chronothermostat p.227

ELECTRIC/MIXED Version
HEATING ELEMENT POSITION
 © Horizontal Heating Element
 On request, EHE in D



STANDARD PRODUCTION

White "sablé" paintwork with brackets
Tolerance ± 3mm - Air vent ø 1/8"

MAXIMUM OPERATING PRESSURE 4 BAR

PRODUCTION ON REQUEST

Brem paintwork - colored brackets +15/25%

Other dimensions on request

Electric version e.Free, page 246

STANDARD FITTING

AC ø 1/2"

On request fitting ø 3/8"

Special fittings, page 287



TAPPING CENTRES

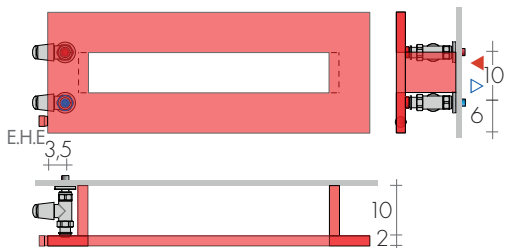

FIXINGS
Brackets included

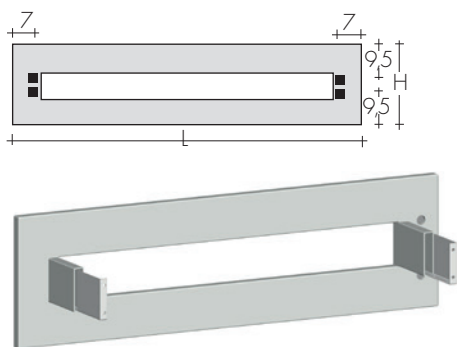

RECOMMENDED VALVES

as standard at the rear of the radiator

CHROME PLATED VALVES KIT WITH:

- n°2 Valves with O-ring Tangs
- n°2 Fittings (multilayer ø16, copper ø12,14)
- n°2 Round washers

On request: Polished stainless tube cover
(to be cut to right size) Art. CA18 10,80€

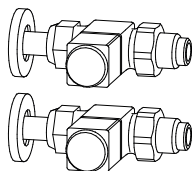

STRAIGHT QUADRA VALVES KIT
page 279 Art. KQD 165,20€
BREM color list extra 46,40€

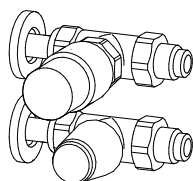

STRAIGHT TON VALVES KIT Art. KVD 129,80€
STRAIGHT TON VALVES KIT with
THERMOSTATIC head Art. KTD 176,00€



REMOTE VALVES ASSEMBLY KIT p. 281 with:
- n°2 Fittings (multilayer ø16, copper ø12,14)

REMOTE TON VALVES ASSEMBLY KIT Art. KVG 153,60€
REMOTE TON VALVES ASSEMBLY KIT with
THERMOSTATIC head Art. KVT 199,80€



FREE 24-124 / KUADRUM 160-55

STRAIGHT MINI VALVES KIT
pag.278 Art. KMD 119,00€

REMOTE FITTINGS Art.REM 36,60€
Remote fittings at the rear: AC▲▽ 10cm



3,5 ++