

GEOMETRICA QUADRA - RETTANGOLARE

design Luigi Brembilla

La collezione Geometrica comprende anche i modelli Quadra e Rettangolare.

I modelli "L" hanno sul retro dei tubi che aumentano la resa calorica. Su richiesta la

barra portasalviette può essere fornita con la sporgenza a sinistra dello scaldasalviette.

QUADRA Mod. Geo-Q

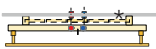

*Mod. Geo-QL con tubi sul retro



Geo-Q..58-56 / 67-65 / 76-74

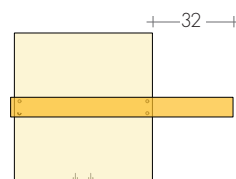

Geo-Q.. 58-87/67-102 / 76-116

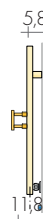

RETTANGOLARE Mod. Geo-R

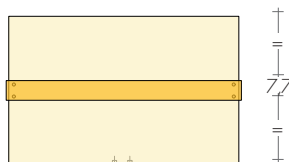

Geo-R 54-92 / 63-102

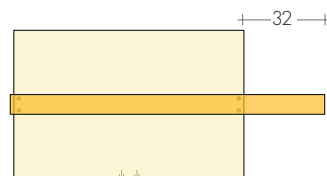

Geo-R 54-123 / 63-138

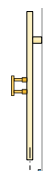

RETTANGOLARE VERTICALE Mod. Geo-RV



*Mod. Geo-RVL con tubi sul retro

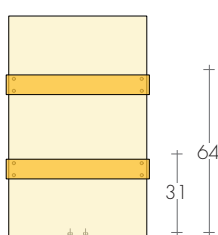

Geo-RV.. 87-56

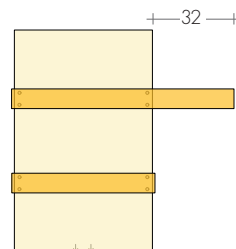

Geo-RV.. 87-87

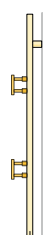

MODELLO	HL cm	Biancodi serie sablé SB9016 €	EN 442			▲ ▽ int.att. cm	Altezza H cm	Larghezza L cm	Peso M Kg	Volume V dm ³	VERSIONI MISTE con Resistenza e manicotto	
			Δt 50K watt	Δt 40K watt	Δt 30K watt						Watt	€
Geo-Q	58-56	845,30	411	312	216	5	58	56	11,6	3,7	400	117,20
Geo-QL	58-56	1023,80	525	399	276	5	58	56	15,2	4,8	500	119,30
Geo-Q	58-87	871,50	444	337	234	5	58	87	12,1	3,9	400	117,20
Geo-QL	58-87	1039,50	558	424	294	5	58	87	15,7	5,0	500	119,30
Geo-Q	67-65	900,90	540	410	284	5	67	65	15,2	4,7	500	119,30
Geo-QL	67-65	1110,90	708	538	372	5	67	65	20,5	6,3	650	121,30
Geo-Q	67-102	932,40	579	440	305	5	67	102	15,9	4,9	500	119,30
Geo-QL	67-102	1137,20	747	568	393	5	67	102	21,2	6,5	800	125,70
Geo-Q	76-74	955,50	685	520	360	5	76	74	19,3	5,8	650	121,30
Geo-QL	76-74	1197,00	918	697	483	5	76	74	26,6	8,0	900	129,00
Geo-Q	76-116	992,30	729	554	383	5	76	116	20,0	6,0	650	121,30
Geo-QL	76-116	1233,80	962	731	506	5	76	116	27,3	8,2	900	129,00
Geo-R	54-92	928,20	635	482	334	5	54	92	17,7	5,4	650	121,30
Geo-R	54-123	965,00	668	508	351	5	54	123	18,2	5,6	650	121,30
Geo-R	63-102	1058,90	802	609	422	5	63	102	22,4	6,7	800	125,70
Geo-R	63-138	1095,70	840	638	442	5	63	138	31,3	9,3	800	125,70
Geo-RV	87-56	950,30	639	486	336	5	87	56	17,5	5,4	650	121,30
Geo-RVL	87-56	1128,80	819	622	431	5	87	56	23,2	7,1	800	125,70
Geo-RV	87-87	976,50	671	510	353	5	87	87	18,1	5,6	650	121,30
Geo-RVL	87-87	1144,50	851	647	448	5	87	87	23,8	7,3	800	125,70

A richiesta, senza supplemento, barra portasalviette con sporgenza a sinistra

Termostati p.208-209

MANIGLIONE GEO COLORI DI SERIE

- bianco sablé SB 9016 - grigio sablé SB 7039
- nero sablé SB 9005 - nel colore del radiatore

In un colore della tabella Brem diverso dallo scaldasalviette Supplemento 49,00€



Attacchi ø 3/8"
DI SERIE
(a filo piastra)



Attacchi ø 1/2"
A RICHIESTA
(con manicotti)

ESECUZIONI DI SERIE

Colore bianco sablé SB9016 mensole bianche
Tolleranze ± 3mm - Valvola di sfiato ø 1/8"
PRESSIONE MASSIMA D'ESERCIZIO 4 BAR

ESECUZIONI A RICHIESTA

Verniciatura in una tinta della tabella colori Brem (con fissaggi B35 colorati) +15/25%
Versione elettrica, e.Geo-Q..R..RV.. p.231

ATTACCHI DI SERIE EG ø 3/8"

A richiesta, senza supplemento, attacchi EG ø 1/2" con manicotti sporgenti 2 cm



INTERASSE ATTACCHI

Attacchi EG $\varnothing 3/8"$, manicotti integrati

Geo-Q.. Geo-RV..

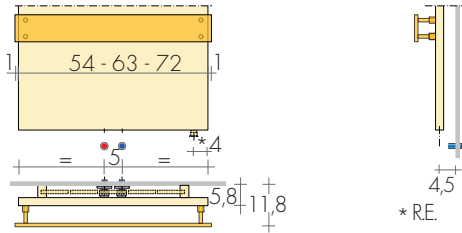

Geo-R..

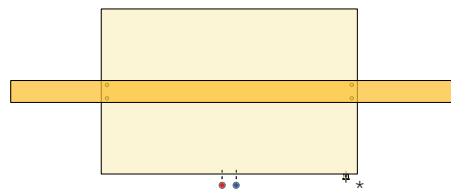
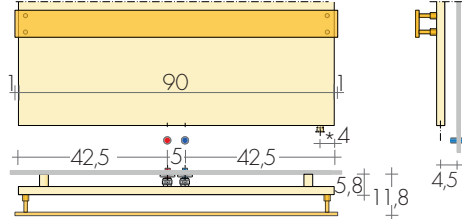

Mod. Geo-R 54-154 (701W) € 1001,70

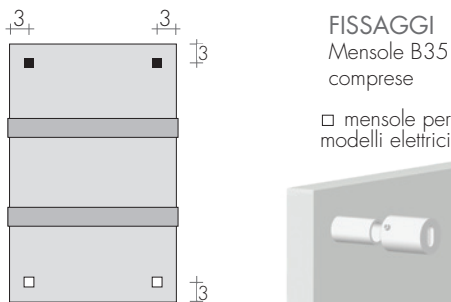

FISSAGGI
Mensole B35
comprese

□ mensole per
modelli elettrici

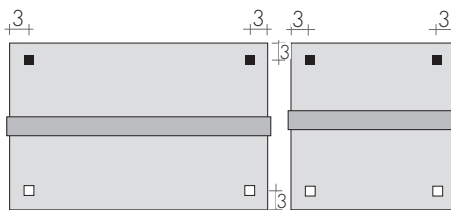

VALVOLE CONSIGLIATE

KIT VALVOLE CROMATE comprende:

- n°2 Valvole con codoli
- n°2 Raccordi (per multistrato $\varnothing 16$ e rame $\varnothing 12$ e 14)
- n°2 Rosette tonde cromo $\varnothing 48$, foro $\varnothing 16$

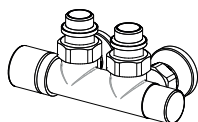

KIT valvola CYL BITUBO SX TERMOSTATIZZABILE
▲▼ 5 cm, pag. 273 Art. KCB 158,80€
Colore tabella BREM supplemento 49,50€

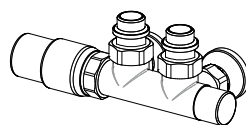

KIT valvola BITUBO SX con testa TERMOSTATICA
▲▼ 5 cm, pag. 274 Art. KTB 186,00€
Colori e finiture speciali pag.266-267

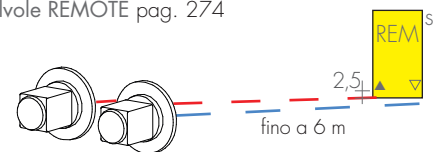

KIT VALVOLE REMOTE TON con testa
TERMOSTATICA, p. 274 Art. KVGT 212,80€



Geo-Q 67-65

con attacchi remoti

FINITURE SPECIALI

pag. 267

Finiture Oro, Bronzo, Nickel spazzolato per 2 valvole

KIT Raccordi NICKEL spazz. suppl.Art. RN 28,20€

ATTACCHI REMOTI

Art. REM 37,60€

Interasse attacchi sul retro: ▲▼ 5 cm

Valvole REMOTE pag. 274