

design Luigi Brebbilla

Herg-ÖT recalls the iconic shape of the ladder and can be placed perpendicular

or slightly inclined. The parallel tubes give comfort and warmth to the bathroom and

work as a support for clothing, bathrobes and towels.

## DIMENSIONS

Width: 42 / 50 / 58 cm  
Height: 184,7 / 212,4 / 240 cm  
Depth: 12 cm  
Depth from wall: 12 cm

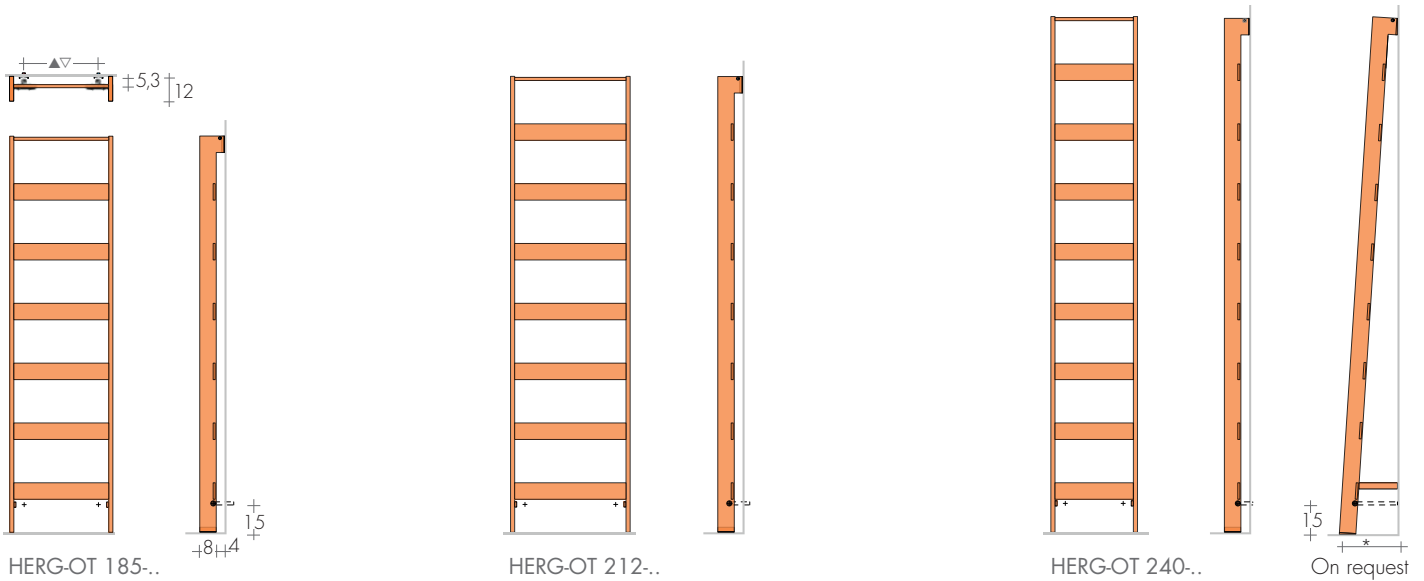

## MODEL'21

MODEL'21	H/L cm	white sablé standard €	EN 442		▲ ▼ t.c. cm	Height H (H <sub>1</sub> ) cm	Width L cm	Weight M Kg	Volume V dm <sup>3</sup>	MIXED version (EHE cl.II) with sleeve and: cable <sup>o</sup> digital thermostat		
			Δt 50 K watt	Δt 30 K watt						€	W	€
HERG-ÖT	185-42	824,20	625	329	27	184	42	11,5	6,0	114,60	650	170,40
HERG-ÖT	185-50	842,50	669	352	35	184	50	12,3	6,3	114,60	650	170,40
HERG-ÖT	185-58	872,40	713	375	43	184	58	13,0	6,5	114,60	650	170,40
HERG-ÖT	212-42	943,20	735	387	27	216	42	13,5	7,1	114,60	650	170,40
HERG-ÖT	212-50	963,30	787	414	35	216	50	14,4	7,3	118,80	800	174,40
HERG-ÖT	212-58	997,20	840	442	43	216	58	15,3	7,6	121,90	900	177,40
HERG-ÖT	240-42	1054,00	845	444	27	248	42	15,6	8,1	118,80	800	174,40
HERG-ÖT	240-50	1075,50	906	476	35	248	50	16,6	8,4	121,90	900	177,40
HERG-ÖT	240-58	1113,10	966	508	43	248	58	17,6	8,7	121,90	900	177,40

On request, ANGLED HERG-ÖT Art. HOI 90,00€

Ready Stock

Δt 40K = W Δt 50K x 0,755

Radio frequency chronothermostat p.227

## STANDARD PRODUCTION

White "sablé" paintwork SB9016  
Tolerance ± 3mm - Air vent ø 1/8"  
MAXIMUM OPERATING PRESSURE 4 BAR

## PRODUCTION ON REQUEST

Paintwork to Brem color list  
(with colored brackets)  
Electric version e.Herg-öt, p.239

+15/25%

## STANDARD FITTING

REG ø 1/2"  
On request fittings ø3/8"  
Special fittings, page 287



TAPPING CENTRES

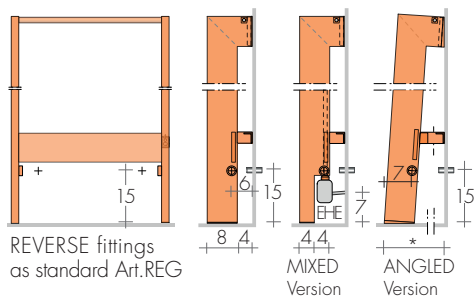

\*On request:  
ANGLED HERGÖT  
Art. HOI 90,00€

Herg-öt 185:\*24 cm  
Herg-öt 212:\*26 cm  
Herg-öt 240:\*28 cm

REMOTE FITTINGS

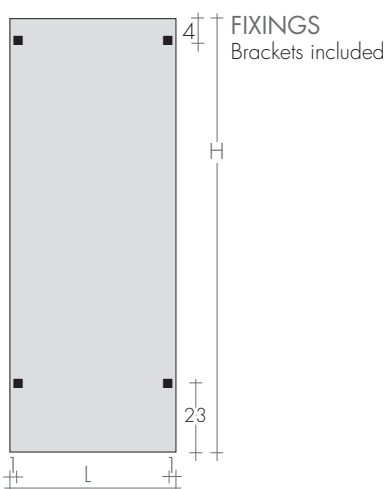
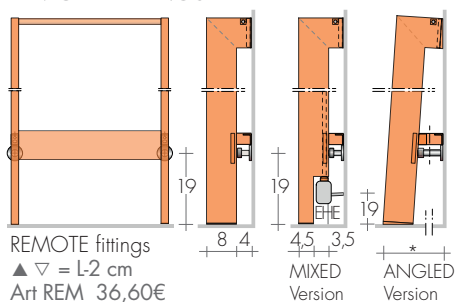

RECOMMENDED VALVES

CHROME PLATED VALVES KIT WITH:

- n°2 Valves with O-ring Tangs
- n°2 Fittings (multilayer ø16, copper ø12,14)
- n°2 Round washers

On request: Polished stainless tube cover  
(to be cut to right size) Art. CA18 10,80€

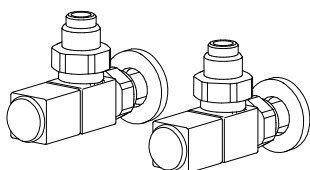

ANGLED QUADRA VALVES KIT  
page 279 Art. KQS 156,60€  
extra for BREM color list 46,40€

ANGLED MINI VALVES KIT  
chrome-plated or white color Art. KMS 107,80€

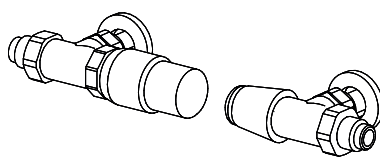

REVERSE TON VALVES KIT with  
THERMOSTATIC head Art. KTR 165,50€  
REVERSE TON VALVES KIT  
page 277 Art. KVR 119,20€

REMOTE FITTINGS Art. REM 36,60€  
Remote fittings at the rear: ▲ ▽ L-2cm

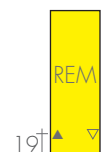

REMOTE VALVES ASSEMBLY KIT p.281 with:  
- n°2 Fittings (multilayer ø16, copper ø12,14)

REMOTE QUADRA VALVES ASSEMBLY KIT  
Art. KQG 167,70€

REMOTE TON VALVES ASSEMBLY KIT with  
THERMOSTATIC head Art. KVG 199,80€



HERGÖT 212-42