

HERG-ÖT

design Luigi Brembilla

Herg-ÖT recalls the iconic shape of the ladder and can be placed perpendicular

or slightly inclined. The parallel tubes give comfort and warmth to the bathroom and

work as a support for clothing, bathrobes and towels.

DIMENSIONS

Width: 42 / 50 / 58 cm
Height: 184,7 / 212,4 cm
Depth: 12 cm
Depth from wall: 12 cm

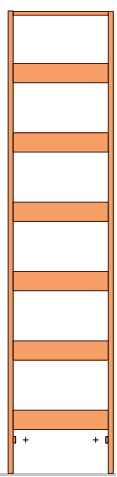
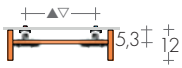

HERG-ÖT 185..

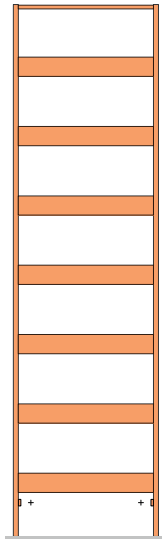
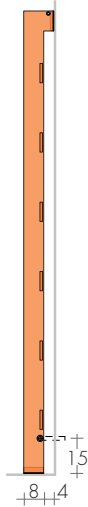

HERG-ÖT 212..

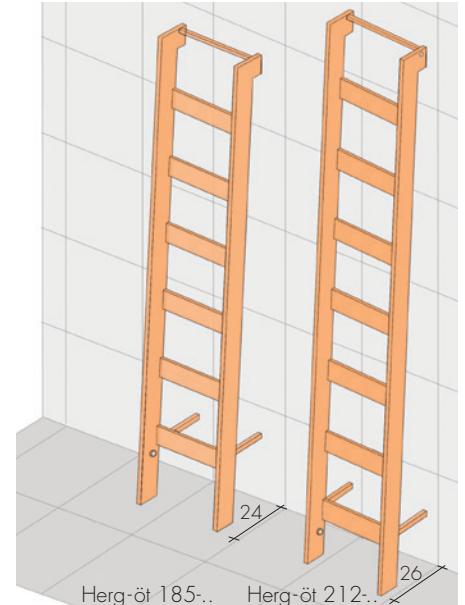
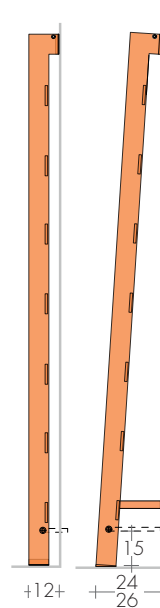

On request: Inclined version Art. HOI

MODEL	H/L cm	Standard white sablé SB 9016 €	EN 442			▲ ▽ t.c. cm	Height H (H _i) cm	Width L cm	Weight M Kg	Volume V dm ³	DUAL FUEL VERSION with E.H.E. and sleeve	
			Δt 50 K watt	Δt 40 K watt	Δt 30 K watt						Watt	€
HERG-ÖT	185-42	995,20	625	472	329	27	184	42	11,5	6,0	650	131,80
HERG-ÖT	185-50	1017,30	669	505	352	35	184	50	12,3	6,3	650	131,80
HERG-ÖT	185-58	1053,40	713	538	375	43	184	58	13,0	6,5	650	131,80
HERG-ÖT	212-42	1138,80	735	555	387	27	216	42	13,5	7,1	800	136,60
HERG-ÖT	212-50	1163,20	787	594	414	35	216	50	14,4	7,3	800	136,60
HERG-ÖT	212-58	1204,20	840	634	442	43	216	58	15,3	7,6	900	140,20

On request, HERG-ÖT INCLINED Art. HOI supplement 108,80€

Thermostats p.208-209

STANDARD PRODUCTION

White "sablé" paintwork SB9016
Tolerance ± 3mm - Air vent ø 1/8"
MAXIMUM OPERATING PRESSURE 4 BAR

PRODUCTION ON REQUEST

Paintwork to Brem color list
(with colored brackets) +15%/25%
Electric version e.Herg-öt, p.234

STANDARD FITTING

REG ø 1/2"
On request fittings ø3/8"
Special fittings, page 279



TAPPING CENTRES

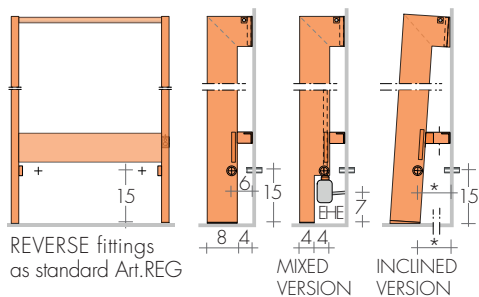

On request
ANGLED HERGÖT
Art. HOI 108,80€

Herg-öt H 185:*17,5 cm
Herg-öt H 212:*19,5 cm

E.H.E.
Electric Heating
Element

REMOTE FITTINGS

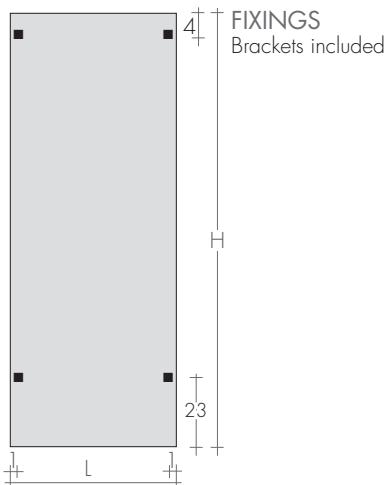
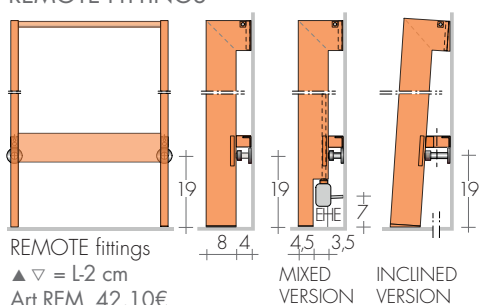

RECOMMENDED VALVES

CHROME VALVES KIT with:
- n°2 Valves with tailpieces
- n°2 Fittings (multilayer ø16, copper ø12, 14)
- n°2 Chrome wall plates ø 48, hole ø16

SPECIAL FINISHES page 267
Finishes Gold, Bronze, Brushed Nickel for 2 valves
Brushed Nickel FITTING KIT extra Art. RN 30,50€

REMOTE FITTINGS Art. REM 42,10€
Tapping centres: at the rear of radiator ▲ ▽ L-2cm
DISTANT Valves page 274

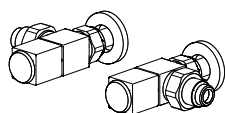
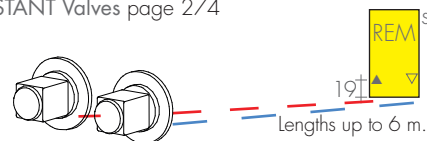

ANGLED QUADRA VALVES KIT
page 271 Art. KQS 180,10€
Extra for BREM color list 53,40€

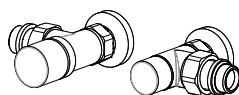

ANGLED CYL VALVES KIT with THERMOSTATIC
option, page.273 Art. KCS 149,90€
Extra for BREM color list 53,40€

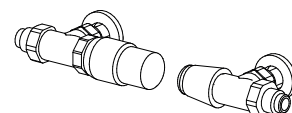

ANGLED TON VALVES KIT with THERMOSTATIC
Head, page 269 Art. KTS 190,30€