

design Davide Brembilla

KUO is an original take on Japanese formalism and essential lines.

Its pure form is the result of using a flat plate with vertical elements laid down its

sides to limit the space and give a sense of slimness and vertical continuity.

DIMENSIONS

Width: 25/35/49 cm
Height: 110/140/180 cm
Depth: 8 cm
Depth from wall: 12 cm

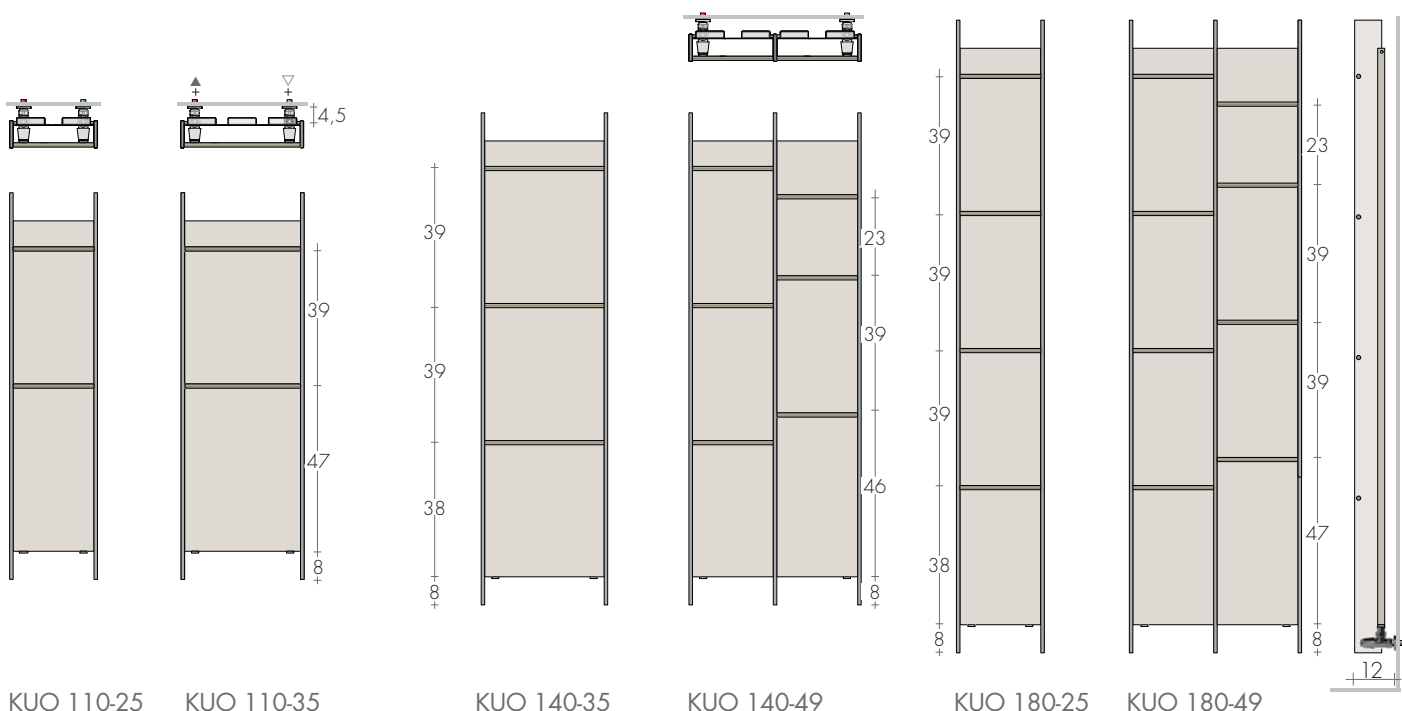

KUO 110-25

KUO 110-35

KUO 140-35

KUO 140-49

KUO 180-25

KUO 180-49

MODEL	HL cm	Standard white sablé €	EN 442		▲ ▼ t.c. cm	Height H cm	Width L cm	Weight M Kg	Volume V dm³	MIXED version (EHE cl.II) with sleeve and: cable ^o digital thermostat		
			Δt 50 K watt	Δt 30 K watt						€	W	€
KUO	110-25	489,40	387	204	17	110	25	8,2	3,8	110,80	400	173,10
KUO	110-35	550,50	475	251	27	110	35	10,1	4,5	112,70	500	175,00
KUO	140-25	560,00	501	264	17	140	25	10,6	5,0	112,70	500	175,00
KUO	140-35	642,00	616	325	27	140	35	13,1	5,8	114,60	650	176,90
KUO	140-49	892,30	873	461	41	140	49	18,6	9,1	121,90	900	184,20
KUO	180-25	700,40	652	344	17	180	25	13,8	6,4	114,60	650	176,90
KUO	180-35	839,20	801	423	27	180	35	17,0	7,5	121,90	900	184,20
KUO	180-49	1020,10	1135	599	41	180	49	24,2	11,8	129,20	1200	191,50

Made to measure dimensions, ask for feasibility

Ready Stock

Δt 40K = WΔt 50K x 0,755

^oRadio frequency chronothermostat p.227

STANDARD PRODUCTION

White "sablé" paintwork - Brackets B35
Tolerance ± 3mm - Air vent ø 1/8"
MAXIMUM OPERATING PRESSURE 4 BAR

PRODUCTION ON REQUEST

Paintwork to Brem color list with colored brackets B35 +15/25%
Electric version e.Kuo, p.262

STANDARD FITTING

EG ø 1/2"
On request fittings ø3/8"
Special fittings, p. 287



TAPPING CENTRES

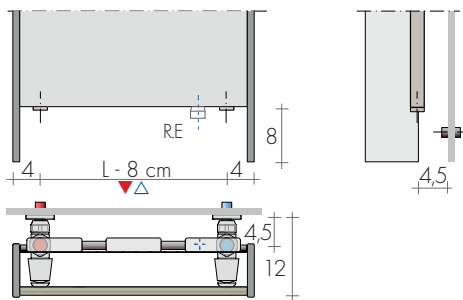

MIXED VERSIONS

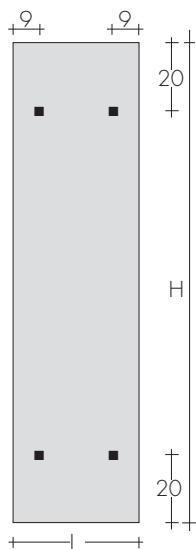
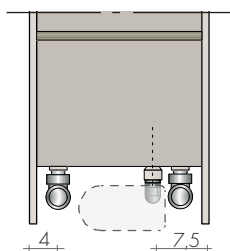

FIXINGS
Brackets included



KUO 180-25

RECOMMENDED VALVES

CHROME PLATED VALVES KIT WITH:

- n°2 Valves with O-ring Tangs
- n°2 Fittings (multilayer ø16, copper ø12,14)
- n°2 Round washers

On request: Polished stainless tube cover
(to be cut to right size) Art. CA18 10,80€

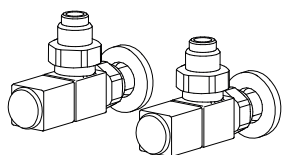

ANGLED QUADRA VALVES KIT
page 279 Art. KQS 156,60€
extra for BREM color list 46,40€

ANGLED MINI VALVES KIT page 278
chrome-plated or white color Art. KMS 107,80€

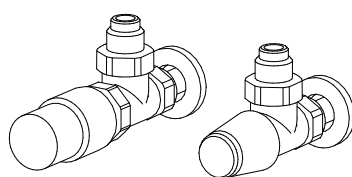

ANGLED TON VALVES KIT with
THERMOSTATIC head Art. KTS 165,50€
ANGLED TON VALVES KIT
page 277 Art. KLS 119,20€

REMOTE FITTINGS Art. REM 36,60€
Remote fittings at the rear: ▲▽L - 8cm

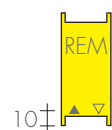
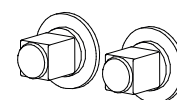

REMOTE VALVES ASSEMBLY KIT p.281 with:
- n°2 Fittings (multilayer ø16, copper ø12,14)

REMOTE QUADRA VALVES ASSEMBLY KIT
Art. KQG 167,70€

REMOTE TON VALVES ASSEMBLY KIT with
THERMOSTATIC head Art. KVGT 199,80€