

Pure high-tech enhanced by stainless steel metallic finish. This heating element in brushed stainless steel comes complete with square stainless steel handles for rarefied

aesthetics. This heated towel rail offers practicality, essence, and beauty.

DIMENSIONS

Width 38 / 52 / 53 / 59 / 63 / 66 cm
 Height 80 / 84 / 130 / 133 / 140 / 180 cm
 Depth 11,5 cm
 Depth from wall 14 cm

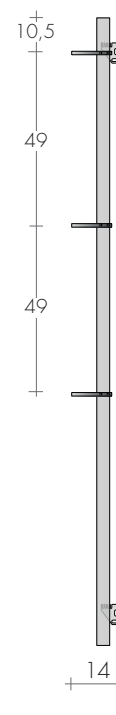
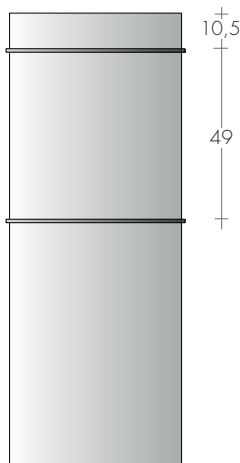

PLATT INOX 80 - 49
 PLATT INOX 84 - 50

PLATT INOX 130 - ...
 PLATT INOX 133-50 / 140-60

PLATT INOX 180 - ...

MODEL	H/L cm	brushed STAINLESS STEEL €	EN 442		▲▽ t.c. cm	Height H cm	Width L cm	Weight M Kg	Volume V dm³	MIXED VERSION *(EHE cl.II) with:		
			Δt 50 K watt	Δt 30 K watt						cable ^o €	W	digital thermostat €
PLATT INOX	80-49	1012,20	388	199	45	80	52	12,1	3,4	-	-	-
PLATT INOX	130-49	1326,20	610	314	45	130	52	18,6	5,2	-	-	-
PLATT INOX	130-56	1428,30	697	359	52	130	59	21,3	6,5	-	-	-
PLATT INOX	130-63	1530,40	784	403	59	130	66	23,8	6,8	-	-	-
PLATT INOX	180-35	1460,50	584	300	31	180	38	18,2	5,0	-	-	-
PLATT INOX	180-49	1624,90	817	420	45	180	52	25,4	7,0	-	-	-
PLATT INOX	180-56	1747,70	934	480	52	180	59	29,1	8,0	-	-	-
PLATT INOX	180-63	1870,50	1051	540	59	180	66	32,7	9,0	-	-	-
										E.H.E. into G		
PLATT INOX	84-50	1084,70	427	219	46,8	84	53	12,5	3,8	89,90	400	152,20
PLATT INOX	133-50	1422,50	645	331	46,8	133	53	19,9	5,9	93,70	650	156,00
PLATT INOX	140-60	1508,40	810	416	56,8	140	63	25,1	7,5	97,90	800	160,20

Stainless steel towel bar as standard for Platt Inox

Δt 40K = Watt Δt 50K x 0,755

*TR accessory or mixed valve
 Radio frequency chronothermostat p.227

MAXIMUM OPERATING PRESSURE 6 BAR

STANDARD PRODUCTION
 Brushed stainless steel surfaces
 Tolerance ± 3mm - Air vent ø1/8"

PRODUCTION ON REQUEST
 Polished stainless steel version
 Electric version e.Platt, page 260

+20% STANDARD FITTING
 EG ø 1/2"
 Fittings on request, page 287



TAPPING CENTRES

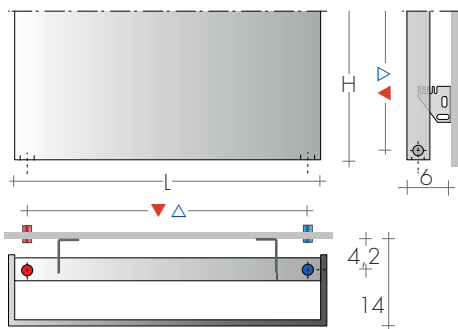

Vertical fittings ▲▽ = L-4 cm

On request side fittings ▲▽ = H-3,2 cm
Art. AS 75,50€

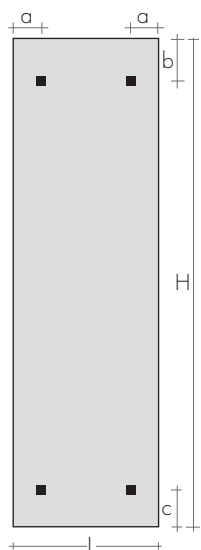

FIXINGS
Brackets included



EOS brackets

Platt Inox Hcm	a cm	b cm	c cm
80, 130, 180	7	8	11
84, 133, 140	6	6,5	5



PLATT INOX 180-35

RECOMMENDED VALVES

CHROME PLATED VALVES KIT WITH:

- n°2 Valves with O-ring Tangs
- n°2 Fittings (multilayer ø16, copper ø12,14)
- n°2 Round washers

On request: Polished stainless tube cover
(to be cut to right size) Art. CA18 10,80€

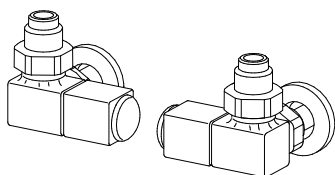

SIDE CONTROL QUADRA VALVE KIT
page 279 Art. KQL 166,30€
CHROME-PLATED SATIN FINISH page 275

ANGLED MINI VALVES KIT page 278
chrome-plated Art. KMS107,80€

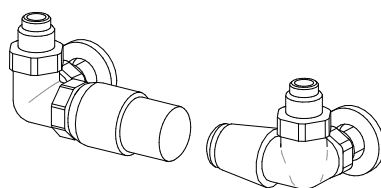

SIDE CONTROL TON VALVES KIT with
THERMOSTATIC head Art. KTL 177,10€
SIDE CONTROL TON VALVES KIT
page 277 Art. KVL 130,90€

REMOTE FITTINGS Art. REM 36,60€
at the rear ▲▽ L-5cm

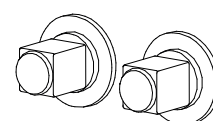

REMOTE VALVES ASSEMBLY KIT p. 281 with:
- n°2 Fittings (multilayer ø16, copper ø12,14)

REMOTE QUADRA VALVES ASSEMBLY KIT
Art. KQG 167,70€
REMOTE TON VALVES ASSEMBLY KIT with
THERMOSTATIC head Art. KVG 199,80€

2,5€

