

SUIT-H naît de tubes plats qui font corps avec les collecteurs, assemblés de façon

à constituer une surface chauffante parfaitement plate, rythmée par l'union des

différents éléments. Il est construit simple ou double et avec des lamelles à l'arrière.

MODELE SUIT-H.. avec tubes plats verticaux

H = de 60 à 220 cm (tous les 20 cm)

L = de 14 à 98 cm (de 1 à 14 elementi)

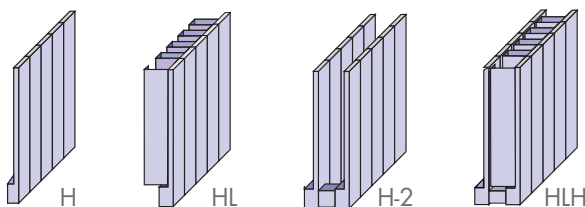

ENTRAXE RACCORDEMENTS

Raccords EG verticaux standard
Raccords latéraux sur demande sans supplément

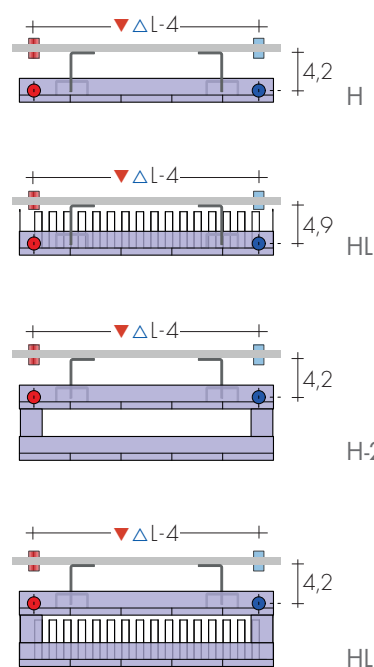
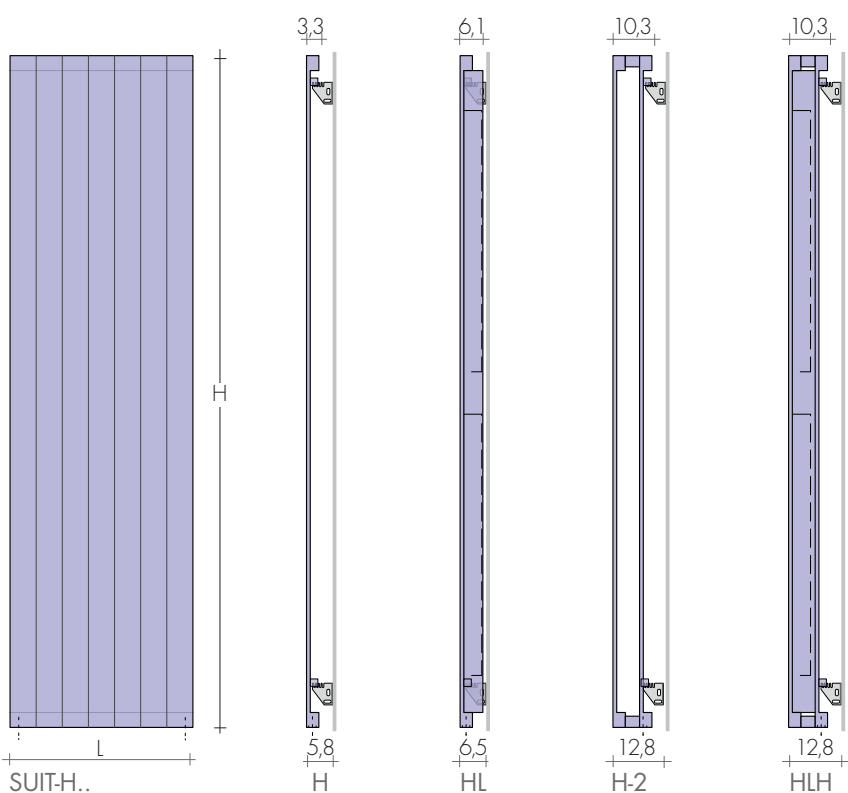
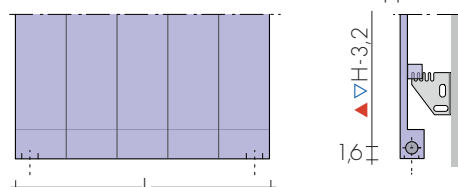

Bandes laterales standard pour panneaux avec lamelles

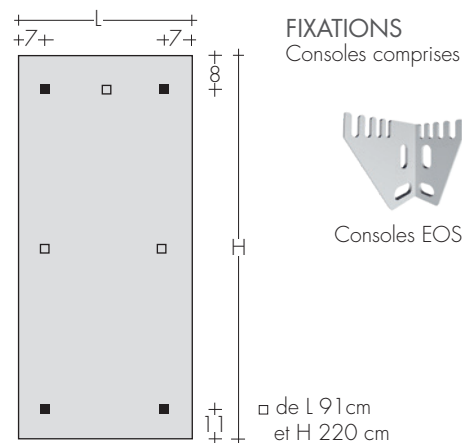

FIXATIONS

Consoles comprises



SUIT-H + lamelles
panneau à l'arrière
hauteur tubes cm
longueur cm
HLH 180 - 49

COMMANDE

Indiquer : modèle (L indique l'application de lamelles) avec hauteur et longueur en cm; raccordement et couleur
ex.: HL 180 - 49, AC ø 1/2", RAL 3005

HAUTEURS SUR DEMANDE

H, HL, H-2, HLH: 120, 140, 150 cm
H, H-2: 300 cm

- Hauteurs tous les 10 cm : rendement calorique et coût selon extension.

- Hauteurs tous les 1 cm : rendement calorique selon extension ; coût : mesure supérieure +20%
Longueurs jusqu'à 1,4m consulter Brem

REALISATIONS STANDARD

Peinture blanc sablé SB9016, consoles EOS
Purgeur ø 1/8" - Tolérances ± 3mm
Pression de service 6 bars,

REALISATIONS SUR DEMANDE

Peinture d'après nuancier Brem jusqu'à 3m +15/25%
(pour valeurs supérieures consulter Brem)

RACCORDEMENTS STANDARD

EG ø 1/2" ▲▽ L-4 cm
Raccords AC ou BD sur demande
Raccords spéciaux, page 278



MOD.	L cm	14	21	28	35	42	49	56	63	70	77	84	91	98	
H cm	(n° el)	(2)	(3)	(4)	(5)	(6)	(7)	(8)	(9)	(10)	(11)	(12)	(13)	(14)	
	▲▼	10	17	24	31	38	45	52	59	66	73	80	87	94	
EN 442 Watt Δt 50K (Δt 40K = Wx0,755) - (Δt 30K = Wx0,526)															
H60	€	182,40 85w	220,80 127w	260,30 170w	299,90 212w	337,20 255w	377,80 297w	417,30 339w	456,10 382w	495,20 424w	533,80 467w	572,90 509w	611,60 551w	651,10 594w	
HL60	€	311,00 138w	354,30 207w	396,00 276w	438,00 345w	478,50 415w	521,40 484w	564,60 553w	606,10 622w	648,10 691w	690,00 760w	732,30 829w	774,30 898w	816,30 967w	
H60-2	€	516,30 141w	593,90 211w	672,00 282w	750,10 352w	828,40 423w	906,30 493w	981,80 564w	1062,00 634w	1139,90 705w	1217,40 775w	1295,50 846w	1373,70 916w	1451,40 987w	
HLH60	€	674,50 197w	746,50 296w	819,20 394w	891,70 493w	964,90 591w	1038,50 690w	1109,70 788w	1183,50 887w	1256,10 986w	1328,90 1084w	1401,50 1183w	1474,40 1281w	1529,10 1380w	
H80	€	213,00 111w	257,90 166w	301,10 221w	348,80 277w	393,30 332w	435,30 388w	480,80 443w	526,30 498w	569,00 554w	614,30 609w	659,30 665w	703,60 720w	748,40 775w	
HL80	€	313,40 177w	358,50 265w	404,00 354w	457,20 442w	508,80 531w	563,50 619w	613,10 708w	665,20 796w	717,40 885w	770,70 973w	821,20 1062w	873,00 1150w	925,00 1239w	
H80-2	€	551,00 179w	638,10 269w	727,40 359w	816,80 448w	906,30 538w	993,60 628w	1082,80 717w	1172,10 807w	1261,60 897w	1348,10 986w	1438,40 1076w	1527,00 1166w	1616,20 1255w	
HLH80	€	677,00 246w	750,40 368w	828,40 491w	919,60 614w	1011,40 737w	1103,20 859w	1194,80 982w	1286,40 1105w	1378,20 1228w	1469,60 1350w	1561,10 1473w	1652,60 1596w	1744,30 1719w	
H100	€	229,60 137w	279,30 205w	328,30 273w	377,80 341w	428,10 410w	478,50 478w	526,30 546w	575,80 614w	626,60 683w	674,50 751w	726,40 819w	774,70 887w	826,10 956w	
HL100	€	334,70 214w	393,30 320w	449,20 427w	507,20 534w	564,60 641w	622,40 747w	680,00 854w	736,30 961w	794,30 1068w	851,60 1174w	910,80 1281w	969,70 1388w	1025,90 1495w	
H100-2	€	587,10 217w	685,80 325w	784,00 434w	882,10 542w	981,80 651w	1080,60 759w	1179,00 867w	1277,50 976w	1378,20 1084w	1476,50 1193w	1574,40 1301w	1674,30 1410w	1772,70 1518w	
HLH100	€	685,80 299w	786,10 448w	887,00 598w	987,80 747w	1087,10 896w	1187,80 1046w	1288,60 1195w	1389,50 1344w	1490,00 1494w	1589,40 1643w	1609,60 1793w	1791,20 1942w	1891,60 2091w	
H160	€	287,30 210w	351,80 315w	417,30 420w	478,50 525w	543,40 630w	608,70 735w	672,00 840w	734,50 945w	799,80 1050w	863,10 1155w	927,60 1260w	993,60 1365w	1054,50 1470w	
HL160	€	446,90 314w	533,00 471w	620,00 629w	704,90 786w	789,80 943w	875,60 1100w	962,60 1257w	1047,60 1414w	1134,90 1572w	1219,60 1729w	1305,50 1886w	1390,10 2043w	1475,60 2200w	
H160-2	€	696,60 326w	819,20 488w	944,80 651w	1070,40 814w	1194,80 977w	1318,10 1139w	1442,40 1302w	1568,00 1465w	1692,40 1628w	1815,70 1790w	1940,40 1953w	2066,10 2116w	2190,20 2279w	
HLH160	€	837,30 431w	983,20 646w	1129,90 862w	1275,30 1077w	1422,00 1293w	1568,00 1508w	1715,40 1724w	1860,00 1939w	2007,90 2155w	2155,10 2370w	2299,90 2586w	2448,20 2801w	2592,90 3017w	
H180	€	325,10 234w	399,40 350w	473,50 467w	546,10 584w	617,80 701w	693,30 817w	766,90 934w	838,80 1051w	913,60 1168w	986,50 1284w	1061,10 1401w	1134,90 1518w	1206,70 1635w	
HL180	€	505,00 344w	602,20 516w	695,40 689w	790,20 861w	886,40 1033w	981,80 1205w	1077,60 1377w	1172,20 1549w	1268,30 1721w	1364,00 1893w	1457,90 2065w	1553,80 2237w	1648,30 2410w	
H180-2	€	757,30 360w	898,20 540w	1037,80 720w	1178,40 900w	1317,80 1079w	1458,60 1259w	1598,40 1439w	1739,50 1619w	1879,00 1799w	2019,60 1979w	2158,10 2159w	2300,00 2339w	2438,70 2518w	
HLH180	€	946,30 474w	1111,60 711w	1279,40 949w	1444,50 1186w	1610,30 1423w	1742,80 1660w	1940,70 1897w	2105,70 2134w	2273,50 2372w	2439,60 2609w	2604,40 2846w	2769,90 3083w	2934,70 3320w	
H200	€	341,20 257w	418,90 385w	495,40 513w	571,80 642w	650,60 770w	723,60 898w	800,90 1026w	877,50 1155w	954,00 1283w	1033,00 1411w	1109,10 1540w	1187,20 1668w	1263,20 1796w	
HL200	€	531,70 371w	633,70 557w	736,80 742w	836,00 928w	939,50 1113w	1041,30 1299w	1144,90 1484w	1246,10 1670w	1348,10 1855w	1450,40 2041w	1553,80 2226w	1657,00 2412w	1758,80 2597w	
H200-2	€	819,20 393w	974,60 590w	1128,60 787w	1284,00 984w	1439,20 1180w	1593,90 1377w	1749,00 1574w	1904,30 1770w	2058,40 1967w	2213,70 2164w	2369,10 2361w	2523,40 2557w	2678,60 2754w	
HLH200	€	984,50 515w	1161,90 772w	1338,80 1030w	1517,40 1287w	1694,80 1544w	1871,50 1802w	2049,20 2059w	2228,10 2317w	2405,40 2574w	2583,10 2832w	2759,90 3089w	2937,10 3346w	3114,70 3604w	
H220	€	356,80 279w	441,70 418w	524,50 557w	605,50 697w	688,00 836w	771,70 976w	855,70 1115w	938,20 1254w	1018,50 1394w	1103,60 1533w	1187,20 1673w	1268,30 1812w	1349,80 1951w	
HL220	€	557,20 401w	665,20 602w	771,70 802w	881,70 1003w	989,20 1204w	1096,10 1404w	1206,70 1605w	1314,40 1806w	1423,00 2006w	1529,20 2207w	1637,40 2407w	1746,60 2608w	1853,20 2809w	
H220-2	€	860,70 426w	1025,70 639w	1192,90 851w	1360,80 1064w	1525,80 1277w	1694,80 1490w	1862,10 1703w	2026,80 1916w	2194,40 2129w	2361,60 2342w	2528,20 2555w	2695,70 2768w	2863,20 2980w	
HLH220	€	1068,10 555w	1262,40 832w	1456,70 1110w	1650,70 1387w	1847,30 1665w	2041,40 1942w	2235,70 2220w	2430,00 2497w	2624,00 2775w	2816,80 3052w	3011,20 3330w	3205,60 3607w	3399,30 3885w	

Δt autres que 50 K : consulter les Données techniques de Brem

ROBINETS CONSEILLES

KIT ROBINETS CHROMÉE avec :

- n°2 Robinets avec cônes
- n°2 Raccords (multicouche ø16 et cuivre ø12, 14)
- n°2 Rondelles cache-trou chromées ø48, trou ø16



KIT ROBINETS commande LATÉRALE TON
page 269 Art. KVL 150,50€

FINITIONS SPECIALES

Finitions Or, Bronze, Nickel brossé, pour 2 robinettes
KIT Raccords NICKEL brossé suppl. Art.RN 30,50€

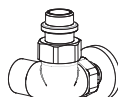
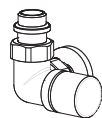

KIT ROBINETS commande LATÉRALE CYL THERMO-
STATISABLE, p.273 Art.KCL 162,50€
Couleur nuancier BREM supplément 53,40€

RACCORD DISTANTS Art. REM 42,10€

Entraxe raccord à l'arrière du radiateur: ▲▼ L - 5 cm
Robinets DISTANTS page 274

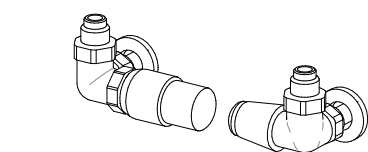

KIT ROBINETS TON commande LATÉRALE, avec
tête thermostatique, p. 269 Art. KTL 203,70€

Dans le modèle SUIT-V, on retrouve la caractéristique de l'assemblage de tubes

plats, où le collecteur et les tubes plats sont placés les uns à côté des autres,

parfaitement intégrés sur un seul et unique plan.

MODELE SUIT-V..
avec tubes plats horizontaux

H = de 28 à 140 cm
(tous les 7 cm)

L = de 50 à 240 cm
(tous les 10 cm)

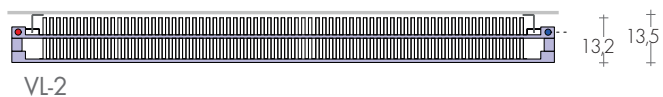
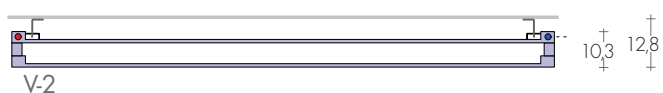
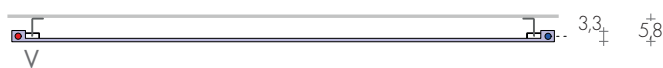
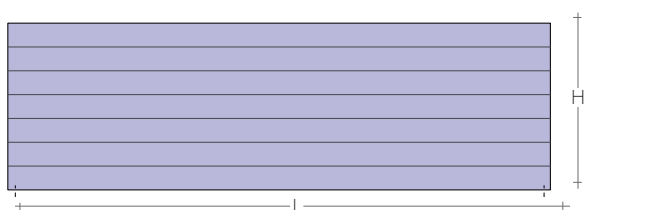
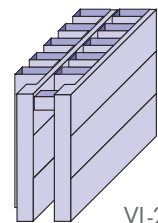
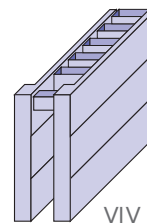
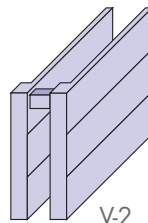
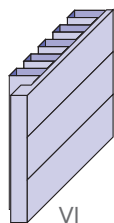
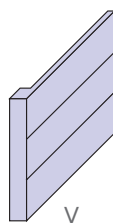

ENTRAXE RACCORDEMENTS

Raccords EG verticaux standard
Raccords latéraux sur demande sans supplément

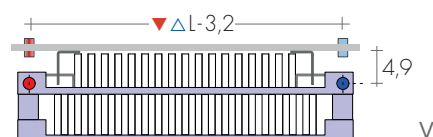
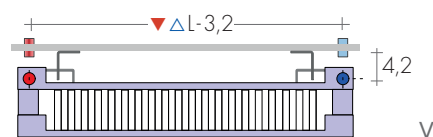
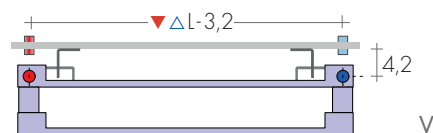
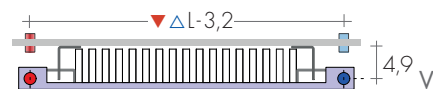
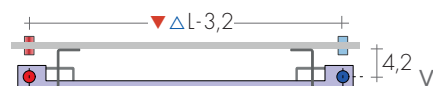
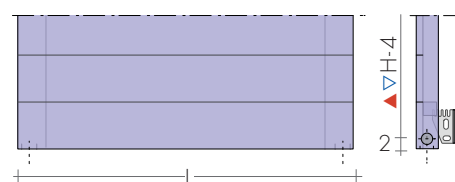

COMMANDE

Indiquer : modèle (L indique l'application de lamelles) avec hauteur et hauteur des lamelles, longueur en cm; raccordement et couleur.
ex.: VL 42/28-180, AC ø 1/2", BR 0002

REALISATIONS STANDARD

Peinture blanc sablé SB9016, consoles EOS
Purgeur ø 1/8" - Tolérances ± 3mm
Pression de service 6 bars

REALISATIONS SUR DEMANDE

Peinture d'après nuancier Brem jusqu'à 3m
+15/25%
(pour valeurs supérieures consulter Brem)

FIXATIONS

Consoles EOS comprises



RACCORDEMENTS STANDARD

EG ø 1/2" ▲▽ L-3,2 cm
Raccords AC ou BD sur demande
Raccords spéciaux page 278

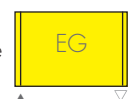



SUIT H 180 - 49

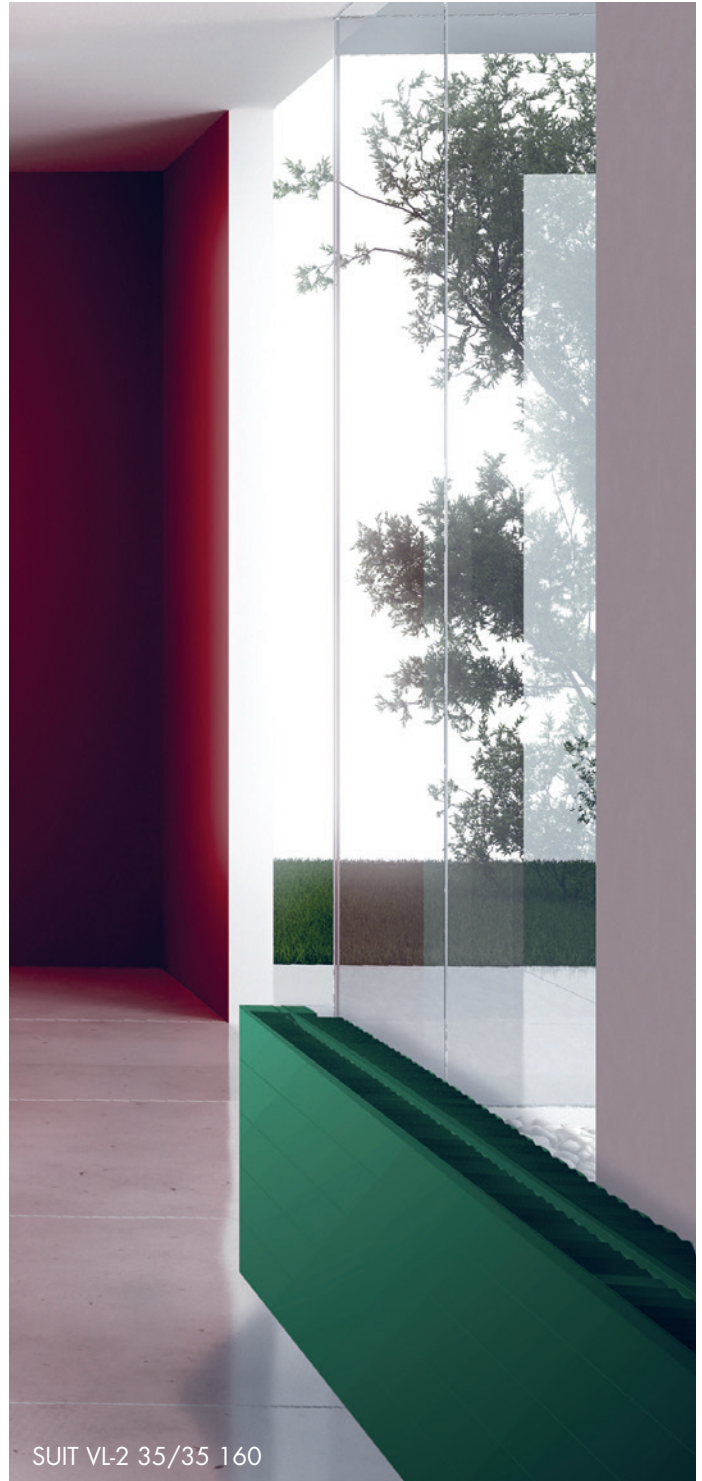

SUIT VL-2 35/35 160

ROBINETS CONSEILLES

KIT ROBINETS CHROMÉE avec :

- n°2 Robinets avec cônes
- n°2 Raccords (multicouche ø16 et cuivre ø12, 14)
- n°2 Rondelles cache-trou chromées ø48, trou ø16

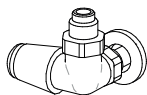

KIT ROBINETS commande LATÉRALE TON
page 269

Art. KVL 150,50€

FINITIONS SPECIALES

Finitions Or, Bronze, Nickel brossé, pour 2 robinettes
KIT Raccords NICKEL brossé suppl. Art.RN 30,50€

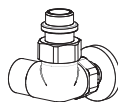
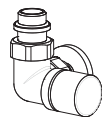

KIT ROBINETS commande LATÉRALE CYL THERMO-
STATISABLE, p.273 Art.KCL 162,50€
Couleur nuancier BREM supplément 53,40€

RACCORD DISTANTS Art. REM 42,10€

Entraxe raccord à l'arrière du radiateur: ▲▽ L - 5 cm
Robinets DISTANTS page 274

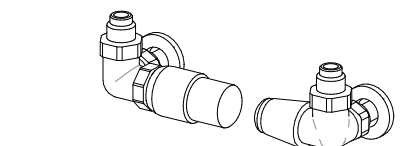
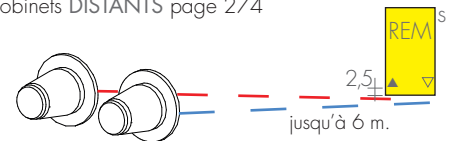

KIT ROBINETS TON commande LATÉRALE, avec
tête thermostatique, p. 269 Art. KTL 203,70€

MOD.	L cm Hcm	EN 442 Watt Δt 50K (Δt 40K = Wx0,755) - (Δt 30K = Wx0,526)															
		50	60	70	80	90	100	110	120	140	160	180	200	220	240		
V28	▲▽cm46,8	€ 279,30	294,20	309,00	323,70	337,20	354,30	370,20	382,40	411,70	441,50	468,30	500,20	528,40	559,10		
VL28/28		€ 406,30	431,00	458,50	481,80	507,20	531,70	556,50	580,30	632,60	681,00	729,90	781,60	830,50	880,20		
V28-2		€ 698,10	728,70	758,00	787,70	815,80	845,30	874,50	901,70	962,60	1019,30	1076,20	1137,20	1193,00	1252,30		
V35		€ 310,40	328,30	345,40	361,30	377,80	397,30	414,00	431,00	464,90	497,80	533,00	566,70	600,40	635,80		
VL35/35		€ 438,00	464,90	492,10	519,60	547,80	573,30	600,40	630,30	684,50	736,30	792,00	846,90	901,70	955,90		
V35-2		€ 760,30	797,70	830,50	863,10	898,10	932,40	967,30	1000,20	1069,20	1137,20	1205,80	1273,90	1343,00	1408,80		
VLV35/35		€ 887,00	931,10	976,40	1020,70	1065,50	1107,50	1152,80	1196,70	1286,40	1375,70	1465,10	1554,60	1641,60	1730,80		
VL35/35-2		€ 1013,60	1070,40	1123,40	1179,00	1233,00	1286,40	1341,60	1396,10	1504,80	1614,40	1724,40	1831,80	1940,40	2050,20		
V42		€ 345,40	363,10	382,40	401,70	420,90	441,50	457,20	476,30	516,30	551,90	590,70	630,30	665,20	704,90		
VL42/28		€ 470,60	500,20	530,50	561,50	588,30	616,70	646,20	674,50	734,50	792,00	851,00	908,50	967,30	1024,00		
VL42/42		€ 476,30	507,20	539,60	569,00	600,40	634,80	665,20	695,90	758,00	821,50	882,10	945,80	1006,90	1069,20		
V42-2		€ 830,50	868,80	906,30	943,00	980,90	1019,30	1057,80	1095,20	1169,80	1245,70	1321,70	1398,40	1472,90	1547,40		
VLV42/28		€ 955,90	1004,50	1054,50	1100,70	1150,50	1196,70	1245,70	1295,30	1391,50	1487,70	1583,90	1678,80	1777,70	1873,80		
VLV42/42		€ 960,50	1011,40	1063,80	1112,00	1160,50	1212,80	1263,50	1313,80	1414,30	1514,00	1614,40	1715,40	1815,70	1916,40		
VL42/28-2		€ 1085,20	1143,50	1201,50	1259,20	1318,10	1375,70	1437,00	1494,20	1609,60	1728,90	1845,30	1960,40	2079,40	2194,50		
VL42/42-2		€ 1093,90	1157,10	1219,60	1281,80	1344,00	1407,30	1469,60	1531,90	1657,30	1781,80	1907,20	2032,10	2157,50	2281,90		
V49		€ 373,20	396,00	417,30	438,00	459,50	480,80	502,30	523,80	566,70	611,10	653,90	698,10	741,30	784,00		
VL49/28		€ 500,20	530,50	563,50	595,20	626,60	659,90	691,50	721,60	787,70	851,60	915,30	978,50	1043,40	1106,40		
VL49/49		€ 504,90	539,60	571,10	608,70	641,30	674,50	708,30	741,30	811,10	878,00	946,80	1014,90	1082,80	1150,50		
V49-2		€ 884,70	927,60	972,90	1017,10	1061,00	1103,20	1146,00	1189,00	1278,50	1363,20	1449,20	1538,80	1623,70	1711,80		
VLV49/28		€ 1011,40	1065,50	1118,90	1172,10	1226,40	1279,60	1331,80	1384,70	1492,50	1598,60	1705,90	1813,70	1918,80	2025,20		
VLV49/49		€ 1016,10	1072,60	1128,00	1181,20	1237,80	1293,20	1348,10	1405,40	1514,00	1625,70	1735,70	1846,40	1958,40	2068,10		
VL49/28-2		€ 1139,00	1201,50	1265,80	1331,80	1394,00	1456,10	1520,30	1585,90	1710,50	1840,50	1965,40	2095,20	2220,00	2349,50		
VL49/49-2		€ 1148,30	1215,20	1284,10	1351,10	1417,60	1487,70	1554,60	1621,20	1758,00	1891,60	2027,40	2162,20	2297,60	2434,50		
V56		€ 409,80	433,30	457,20	480,80	504,90	528,40	549,80	573,30	622,40	669,80	717,40	764,50	813,30	860,90		
VL56/28		€ 537,50	569,00	603,50	635,80	669,80	706,90	738,80	773,90	839,60	908,50	976,40	1045,70	1113,40	1180,30		
VL56/56		€ 554,60	595,20	634,80	674,50	713,00	754,50	792,00	830,50	908,50	988,80	1067,10	1146,00	1225,30	1304,70		
V56-2		€ 956,90	1004,50	1051,90	1100,10	1148,30	1195,80	1241,20	1288,60	1384,70	1481,10	1576,10	1672,40	1764,90	1860,90		
VLV56/28		€ 1082,80	1141,50	1199,20	1256,80	1315,40	1373,70	1429,00	1487,70	1603,10	1719,50	1836,20	1951,70	2066,10	2182,40		
VLV56/56		€ 1100,70	1165,00	1228,20	1290,90	1353,30	1417,60	1481,10	1543,10	1670,60	1795,60	1922,40	2047,60	2175,80	2299,90		
VL56/28-2		€ 1210,60	1277,50	1346,70	1416,20	1483,40	1550,10	1619,00	1688,10	1822,50	1960,40	2095,20	2233,10	2366,60	2506,30		
VL56/56-2		€ 1245,70	1327,00	1405,40	1483,40	1561,10	1639,50	1719,50	1797,50	1953,80	2112,10	2269,60	2425,40	2584,00	2610,90		
V63		€ 441,50	467,40	492,10	519,60	545,20	573,30	600,40	626,60	680,00	732,00	787,70	839,60	893,80	946,80		
VL63/35		€ 566,70	603,50	641,30	677,90	714,80	752,20	787,70	826,10	899,50	972,90	1047,60	1121,30	1193,00	1267,10		
VL63/63		€ 587,10	630,30	672,00	713,00	756,20	799,80	839,60	882,10	967,30	1050,00	1137,20	1219,60	1304,70	1390,10		
V63-2		€ 1019,30	1073,50	1126,80	1180,30	1234,60	1286,40	1339,70	1394,70	1498,70	1608,80	1715,40	1823,70	1927,60	2036,40		
VLV63/35		€ 1148,30	1212,80	1275,30	1339,70	1403,00	1466,20	1529,80	1594,10	1722,10	1848,80	1976,40	2103,20	2230,70	2357,50		
VLV63/63		€ 1165,00	1234,60	1304,70	1373,70	1442,40	1511,30	1579,50	1648,40	1786,60	1925,70	2061,70	2199,10	2338,30	2474,30		
VL63/35-2		€ 1272,90	1346,70	1419,80	1494,20	1568,00	1643,70	1717,50	1791,20	1938,90	2086,20	2233,10	2380,10	2531,00	2678,10		
VL63/63-2		€ 1313,80	1396,10	1481,10	1565,80	1650,80	1733,20	1818,40	1902,70	2072,70	2240,10	2409,70	2577,50	2746,90	2916,60		

PANNEAUX

MOD.	L cm	EN 442 Watt Δt 50K (Δt 40K = Wx0,755) - (Δt 30K = Wx0,526)													
		50	60	70	80	90	100	110	120	140	160	180	200	220	240
V70	▲▽ cm 46,8	56,8	66,8	76,8	86,8	96,8	106,8	116,8	136,8	156,8	176,8	196,8	216,8	236,8	
VL70/35	€	488,90	519,60	547,80	579,20	608,70	638,10	669,80	698,10	758,00	821,50	880,20	941,20	1000,20	1061,00
VL70/70	€	614,30	656,40	693,60	734,50	776,20	815,80	856,60	898,10	976,40	1057,80	1138,40	1219,60	1300,10	1380,40
V70-2	€	634,80	680,00	726,40	770,70	815,80	860,90	906,30	951,40	1043,40	1134,90	1225,30	1319,10	1408,80	1498,70
VLV70/35	€	1114,20	1174,20	1236,50	1297,70	1356,70	1417,60	1475,60	1536,30	1658,80	1778,70	1897,30	2019,50	2139,30	2259,70
VLV70/70	€	1243,60	1313,80	1384,70	1453,60	1525,10	1596,60	1666,10	1737,90	1878,10	2019,50	2159,90	2302,50	2443,80	2584,10
VL70/35-2	€	1261,60	1337,60	1413,60	1490,00	1565,80	1641,60	1715,40	1791,20	1942,60	2095,20	2246,80	2399,50	2549,90	2702,90
VL70/70-2	€	1371,40	1451,40	1531,90	1612,40	1695,70	1772,70	1855,50	1935,80	2096,40	2260,50	2421,10	2581,90	2744,60	2905,20
V77	€	1407,30	1498,70	1589,40	1681,30	1772,70	1862,40	1953,80	2045,70	2228,80	2412,10	2595,30	2778,40	2958,00	3141,90
VL77/35	€	528,40	563,50	592,70	626,60	658,30	691,50	721,60	754,50	818,00	882,10	946,80	1012,70	1076,20	1140,30
VL77/70	€	656,40	698,10	741,30	784,00	826,10	868,80	910,80	954,10	1039,70	1124,80	1209,40	1295,30	1378,20	1465,10
V77-2	€	674,50	721,60	770,70	818,00	865,50	915,30	962,60	1010,40	1106,40	1201,50	1297,70	1392,80	1486,60	1581,60
VLV77/35	€	1197,80	1260,10	1326,30	1390,10	1453,60	1519,40	1583,90	1648,40	1778,70	1904,00	2034,40	2163,10	2291,00	2421,10
VLV77/70	€	1326,30	1400,80	1473,80	1550,10	1623,70	1699,40	1772,70	1847,60	1997,10	2145,90	2295,60	2444,70	2592,90	2742,10
VL77/35-2	€	1451,40	1536,30	1621,20	1705,90	1791,20	1875,60	1962,80	2045,70	2215,00	2384,80	2554,70	2724,40	2896,20	3063,50
VL77/70-2	€	1490,00	1585,90	1678,80	1775,10	1870,80	1965,40	2061,40	2157,50	2347,70	2538,00	2728,90	2921,10	3031,10	3301,30
V84	€	569,00	606,10	641,30	674,50	710,40	746,50	781,60	818,00	887,00	959,40	1028,70	1100,10	1172,10	1241,20
VL84/35	€	695,90	741,30	787,70	832,70	878,00	922,90	969,70	1014,90	1106,40	1195,80	1286,40	1380,40	1471,80	1562,40
VL84/70	€	714,80	764,50	818,00	868,80	919,60	970,70	1021,80	1071,50	1174,20	1276,00	1378,20	1481,10	1581,60	1684,70
V84-2	€	1278,50	1349,60	1419,80	1491,20	1560,30	1632,70	1703,90	1772,70	1914,20	2057,70	2199,10	2338,30	2479,70	2621,10
VLV84/35	€	1407,30	1487,70	1570,20	1650,80	1730,80	1813,70	1894,10	1974,10	2137,40	2297,60	2460,80	2623,50	2784,80	2948,60
VLV84/70	€	1424,30	1511,30	1598,60	1683,50	1770,70	1857,50	1942,60	2029,60	2201,60	2373,30	2548,10	2719,70	2892,10	3066,10
VL84/35-2	€	1534,00	1625,70	1717,50	1808,90	1900,80	1992,40	2081,70	2173,10	2356,60	2538,50	2721,90	2903,20	3086,40	3269,70
VL84/70-2	€	1572,70	1673,10	1775,10	1875,60	1979,90	2081,70	2182,40	2284,00	2487,60	2691,40	2894,00	3099,90	3303,70	3505,70
V91	€	603,50	641,30	680,00	717,40	756,20	794,30	832,70	872,60	946,80	1025,90	1103,20	1180,30	1256,80	1331,80
V91-2	€	1343,00	1419,80	1495,50	1573,60	1651,80	1727,40	1804,80	1880,50	2036,40	2190,00	2345,20	2497,70	2650,70	2806,70
V98	€	634,80	677,90	717,40	758,00	802,30	841,60	882,10	925,30	1006,90	1090,40	1174,20	1258,30	1339,70	1424,30
V98-2	€	1408,80	1493,30	1576,10	1660,80	1740,70	1826,00	1908,50	1993,60	2158,40	2325,90	2491,10	2658,80	2824,10	2991,40
V112	€	714,80	760,30	809,10	854,30	901,70	949,40	994,40	1043,40	1137,20	1230,90	1323,50	1419,80	1512,80	1606,50
V112-2	€	1569,00	1663,20	1757,10	1852,30	1945,80	2038,60	2132,80	2225,20	2414,50	2599,60	2789,00	2976,20	3163,30	3352,20
V126	€	792,00	845,30	898,10	949,40	1002,30	1054,50	1108,60	1160,50	1264,90	1371,40	1475,60	1581,60	1686,60	1791,20
V126-2	€	1725,40	1830,80	1934,80	2041,10	2145,10	2251,50	2356,60	2461,80	2671,10	2882,70	3092,30	3303,70	3513,80	3724,20
V140	€	865,50	925,30	983,20	1043,40	1100,10	1160,50	1219,60	1278,50	1394,70	1512,80	1630,30	1748,90	1866,90	1984,40
V140-2	€	1873,80	1991,40	2107,80	2225,20	2343,20	2461,80	2579,50	2694,80	2931,30	3165,80	3401,10	3636,00	3870,30	4108,50

Δt autres que 50 K : consulter les Données techniques de Brem

V panneau horizontal

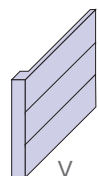

VL panneau avec lamelles

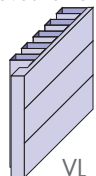

V-2 panneau double

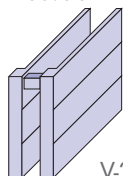

VLV panneau double avec lamelles

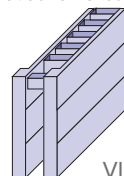

VL-2 panneau double avec doubles lamelles

